



KIKUSUI

Part No. IB033875
Mar 2021

Communication Interface Manual

TOS93 Series Electrical Safety Analyzer

TOS9300

TOS9301

TOS9301PD

TOS9302

TOS9303

TOS9303LC

Contents

Command List	8	CALC:SCAL:OFFS:AUTO	77
Introduction	37	CALC:ACW Command	78
Setup	40	CALC:ACW:SCAL.....	78
Installing the VISA Library.....	40	CALC:ACW:SCAL:OFFS.....	79
Setting Up the Interface.....	41	CALC:ACW:SCAL:OFFS:IMAG.....	79
RS232C	42	CALC:DCW Command	80
USB	44	CALC:DCW:SCAL	80
LAN.....	46	CALC:DCW:SCAL:OFFS.....	81
Accessing and Operating the Product from a Web Browser (LAN).....	50	CALC:EC Command	82
About Commands	57	CALC:EC:SCAL.....	82
Command Hierarchy.....	57	CALC:EC:SCAL:OFFS	82
Command Syntax	58	CALC:EC:DC:SCAL.....	83
Parameters	61	CALC:EC:DC:SCAL:OFFS	83
IEEE 488.2 common commands 65		CALC:IR Command	84
*CLS	65	CALC:IR:SCAL	84
*ESE	65	CALC:IR:SCAL:OFFS.....	84
*ESR.....	66	CALC:MET Command	85
*IDN	66	CALC:MET:SCAL.....	85
*OPC.....	67	CALC:MET:SCAL:OFFS	85
*OPT	67	CALC:PAT Command	86
*PSC.....	68	CALC:PAT:SCAL.....	86
*RCL	68	CALC:PAT:SCAL:OFFS	86
*RST	69	CALC:PAT:SCAL:CONV	87
*SAV	72	CALC:PAT:SCAL:CONV:VOLT	87
*SRE	72	CALC:PCC Command	88
*STB	73	CALC:PCC:SCAL	88
*TRG.....	73	CALC:PCC:SCAL:OFFS.....	88
*TST.....	74	CALC:PCC:SCAL:CONV.....	89
*WAI.....	74	CALC:PCC:SCAL:CONV:VOLT	89
ABORt Command	75	CALC:PD Command	90
ABOR.....	75	CALC:PD:PREC	90
ABOR:ACQ.....	76	CALC:PD:PREC:EXEC	91
ABOR:TEST	76	CALC:PD:PREC:STAT.....	91
CALCulate Command	77		

CALC:PD:VOLT:EXT:THR	92	MEAS:COUL.....	112
CALC:PD:VOLT:INC:THR.....	92	FETC:CRE/ READ:CRE/ MEAS:CRE	113
CALC:TC Command.....	93	FETC:CURR/ READ:CURR/	
CALC:TC:SCAL.....	93	MEAS:CURR	113
CALC:TC:SCAL:OFFS	93	FETC:ETIM/ READ:ETIM/ MEAS:ETIM ..	114
CALC:TC:SCAL:CONV.....	94	FETC:RES/ READ:RES/ MEAS:RES.	114
CALC:TC:SCAL:CONV:VOLT.....	94	FETC:VOLT/ READ:VOLT/ MEAS:VOLT.	115
DATA Command.....	95	OUTPut Command.....	116
DATA:BSIZ.....	95	OUTP.....	116
DATA:FORM	96	OUTP:110P.....	116
DATA:POIN.....	97	OUTP:110P:POL.....	117
DATA:REM.....	98	PROGram Command.....	118
Display Command	99	PROG	118
DISP:ACW:CURR:PHOL.....	99	PROG:CRE.....	119
DISP:DCW:CURR:PHOL.....	100	PROG:DEL	120
DISP:EC:AC:CURR:PHOL	101	PROG:INT:TIM.....	120
DISP:EC:DC:CURR:PHOL.....	101	PROG:FAIL:COUT.....	121
DISP:IR:RES:PHOL.....	102	PROG:LIST.....	121
DISP:PAT:CURR:PHOL	103	PROG:OUTP:CONT	122
DISP:PCC:CURR:PHOL.....	104	PROG:REN.....	122
DISP:PD:COUL:PHOL.....	105	PROG:SAVE.....	123
DISP:TC:CURR:PHOL	106	PROG:STEP<n>:<prog_item>	124
GRAPh Command	107	PROG:STEPS:COUN.....	126
GRAP:PD:FORM.....	107	RESult command.....	127
GRAP:PD:MARK	108	RES:FORM.....	127
GRAP:PD:SCAL	108	RES	128
HCOPy Command.....	109	RES:COUN.....	131
HCOP:SDUM:DATA.....	109	RES:REM	131
INITiate Command	110	RES:TZON.....	132
INIT.....	110	ROUTe Command	133
INIT:ACQ.....	110	ROUT:ACW:TERM	133
INIT:TEST	110	ROUT:ACW:TERM:CCH.....	134
MEASure/READ/FETCh Command		ROUT:CAT	135
111		ROUT:DCW:TERM	136
FETC/ READ/ MEAS	111	ROUT:DCW:TERM:CCH	137
FETC:CIM/ READ:CIM/ MEAS:CIM ...	112	ROUT:IR:TERM	138
FETC:COUL/ READ:COUL/		ROUT:IR:TERM:CCH	139
		ROUT:TERM:CONT:FAIL.....	140

SAMPlE command 141

SAMP:COUN 141
SAMP:TEST:ENAB 142
SAMP:TIM 143

SENSe:ACW Command 144

SENS:ACW:CURR:FILT:HPAS 144
SENS:ACW:CURR:FILT:LPAS 145
SENS:ACW:CURR:FILT:TYPE 146
SENS:ACW:CURR:MODE 147
SENS:ACW:JUDG 147
SENS:ACW:JUDG:LOW 148
SENS:ACW:JUDG:LOW:STAT 148
SENS:ACW:TERM:GRO 149
SENS:ACW:VOLT:MODE 149

SENSe:DCW Command 150

SENS:DCW:CURR:FILT:HPAS 150
SENS:DCW:CURR:FILT:LPAS 151
SENS:DCW:CURR:FILT:TYPE 152
SENS:DCW:JUDG 152
SENS:DCW:JUDG:DEL 153
SENS:DCW:JUDG:DEL:AUTO 153
SENS:DCW:JUDG:LOW 154
SENS:DCW:JUDG:LOW:STAT 154
SENS:DCW:TERM:GRO 155
SENS:DCW:VOLT:MODE 155

SENSe:EC Command 156

SENS:EC[:AC] Command 156
SENS:EC:JUDG 156
SENS:EC:JUDG:STAT 157
SENS:EC:JUDG:LOW 158
SENS:EC:JUDG:LOW:STAT 158
SENS:EC:JUDG:TYPE 159
SENS:EC:JUDG:VOLT 160
SENS:EC:JUDG:VOLT:STAT 160
SENS:EC:JUDG:VOLT:LOW 161
SENS:EC:JUDG:VOLT:LOW:STAT ... 161
SENS:EC:TERM:CCH 162
SENS:EC:TERM:WIRE 162
SENS:EC:DC Command 163
SENS:EC:DC:JUDG 163
SENS:EC:DC:JUDG:STAT 163

SENS:EC:DC:JUDG:LOW 164
SENS:EC:DC:JUDG:LOW:STAT 164
SENS:EC:DC:JUDG:TYPE 165
SENS:EC:DC:JUDG:VOLT 166
SENS:EC:DC:JUDG:VOLT:STAT 166
SENS:EC:DC:JUDG:VOLT:LOW 167
SENS:EC:DC:JUDG:VOLT:LOW:STAT ... 167
SENS:EC:DC:TERM:CCH 168
SENS:EC:DC:TERM:WIRE 168

SENSe:IR Command 169

SENS:IR:CURR:FILT:LPAS:STAT 169
SENS:IR:JUDG 170
SENS:IR:JUDG:STAT 170
SENS:IR:JUDG:CURR 171
SENS:IR:JUDG:CURR:STAT 171
SENS:IR:JUDG:CURR:LOW 172
SENS:IR:JUDG:CURR:LOW:STAT ... 172
SENS:IR:JUDG:DEL 173
SENS:IR:JUDG:DEL:AUTO 173
SENS:IR:JUDG:LOW 174
SENS:IR:JUDG:LOW:STAT 174
SENS:IR:JUDG:TYPE 175
SENS:IR:TERM:GRO 175

SENSe:MET Command 176

SENS:MET:CURR:MODE 176
SENS:MET:NETW 177
SENS:MET:RANG 178
SENS:MET:RANG:AUTO 179
SENS:MET:SELV 180
SENS:MET:SELV:STAT 180
SENS:MET:TERM 181

SENSe:PAT Command 182

SENS:PAT:BAND 182
SENS:PAT:COND 183
SENS:PAT:COND:FAUL 183
SENS:PAT:CURR:MODE 184
SENS:PAT:JUDG 185
SENS:PAT:JUDG:STAT 185
SENS:PAT:JUDG:DEL 186
SENS:PAT:JUDG:DEL:STAT 186

SENS:PAT:JUDG:LOW	187	SENS:TC:JUDG:DEL:STAT	210
SENS:PAT:JUDG:LOW:STAT	187	SENS:TC:JUDG:LOW	211
SENS:PAT:NETW	188	SENS:TC:JUDG:LOW:STAT	211
SENS:PAT:NETW:PROB	189	SENS:TC:NETW	212
SENS:PAT:NETW:PROB:A	190	SENS:TC:NETW:PROB	213
SENS:PAT:RANG:AUTO	190	SENS:TC:NETW:PROB:A	213
SENS:PAT:TIM	191	SENS:TC:RANG:AUTO	214
SENS:PAT:TIM:STAT	191	SENS:TC:TIM	215
		SENS:TC:TIM:STAT	215
SENSe:PCC Command	192	[SOURce:] command.....	216
SENS:PCC:BAND	192	FUNC	216
SENS:PCC:COND	193		
SENS:PCC:COND:FAUL	194	[SOURce:]ACW Command	217
SENS:PCC:CURR:MODE	194	ACW:VOLT	217
SENS:PCC:JUDG	195	ACW:VOLT:END:STAT	218
SENS:PCC:JUDG:STAT	195	ACW:VOLT:FREQ	219
SENS:PCC:JUDG:DEL	196	ACW:VOLT:PROT	219
SENS:PCC:JUDG:DEL:STAT	196	ACW:VOLT:STAR	220
SENS:PCC:JUDG:LOW	197	ACW:VOLT:STAR:STAT	220
SENS:PCC:JUDG:LOW:STAT	197	ACW:VOLT:SWE:FALL:TIM	221
SENS:PCC:NETW	198	ACW:VOLT:SWE:FALL:TIM:STAT	221
SENS:PCC:RANG:AUTO	198	ACW:VOLT:SWE:TIM	222
SENS:PCC:TIM	199	ACW:VOLT:TIM	223
SENS:PCC:TIM:STAT	199	ACW:VOLT:TIM:STAT	223
SENSe:PD command.....	200	[SOURce:]DCW Command	224
SENS:PD:FILT:BPAS	200	DCW:VOLT	224
SENS:PD:FILT:LPAS:STAT	201	DCW:VOLT:DISC:INT:STAT	224
SENS:PD:JUDG	202	DCW:VOLT:DISC:TIM	225
SENS:PD:JUDG:STAT	202	DCW:VOLT:END:STAT	225
SENS:PD:JUDG:PCO	203	DCW:VOLT:PROT	226
SENS:PD:JUDG:PCO:STAT	203	DCW:VOLT:STAR	227
SENS:PD:PCO:THR	204	DCW:VOLT:STAR:STAT	227
SENS:PD:RANG	204	DCW:VOLT:SWE:FALL:TIM	228
SENS:PD:VOLT:MODE	205	DCW:VOLT:SWE:FALL:TIM:STAT	228
		DCW:VOLT:SWE:TIM	229
		DCW:VOLT:TIM	230
		DCW:VOLT:TIM:STAT	230
SENSe:TC Command	206	[SOURce:]EC Command	231
SENS:TC:BAND	206	EC:AC:CURR	231
SENS:TC:COND	207	EC:AC:CURR:PROT	231
SENS:TC:COND:FAUL	207	EC:AC:CURR:SWE:FALL:TIM	232
SENS:TC:CURR:MODE	208		
SENS:TC:JUDG	209		
SENS:TC:JUDG:STAT	209		
SENS:TC:JUDG:DEL	210		

EC:AC:CURR:SWE:FALL:TIM:STAT	232	PD:VOLT:STEP:TIM	254
EC:AC:CURR:SWE:TIM	233	PD:VOLT:SWE:FALL:TIM	255
EC:AC:CURR:TIM	234	PD:VOLT:SWE:FALL:TIM:STAT	255
EC:AC:CURR:TIM:STAT	234	PD:VOLT:SWE:TIM	256
EC:CURR:FREQ	235	PD:VOLT:TIM	257
EC:DC:CURR	235	PD:VOLT:TIM:STAT	257
EC:DC:CURR:PROT	236		
EC:DC:CURR:SWE:FALL:TIM	237	[SOURCE:]TC Command	258
EC:DC:CURR:SWE:FALL:TIM:STAT	237	TC:110P:OUTP	258
EC:DC:CURR:SWE:TIM	238	TC:110P:POL	258
EC:DC:CURR:TIM	239	TC:POL	259
EC:DC:CURR:TIM:STAT	239		
		STATus Command	260
[SOURCE:]IR command	240	Status Report Structure	260
IR:TERM:POL	240	Architecture	261
IR:VOLT	240	Status byte register	262
IR:VOLT:DISC:INT:STAT	241	Event status register	263
IR:VOLT:DISC:TIM	241	OPERation status register	264
IR:VOLT:PROT	242	STAT:OPER	265
IR:VOLT:RANG	243	STAT:OPER:<bit-item>	265
IR:VOLT:STAR	244	STAT:OPER:COND	266
IR:VOLT:STAR:STAT	244	STAT:OPER:COND:<bit-item>	266
IR:VOLT:SWE:TIM	245	STAT:OPER:ENAB	267
IR:VOLT:TIM	246	STAT:OPER:ENAB:<bit-item>	267
IR:VOLT:TIM:STAT	246	STAT:OPER:NTR	268
		STAT:OPER:NTR:<bit-item>	268
		STAT:OPER:PTR	269
[SOURCE:]PATient Command	247	STAT:OPER:PTR:<bit-item>	269
PAT:110P:OUTP	247	OPERation:PROTecting Status Register	270
PAT:110P:POL	247	STAT:OPER:PROT	271
PAT:POL	248	STAT:OPER:PROT:COND	271
		STAT:OPER:PROT:ENAB	271
[SOURCE:]PCC Command	249	STAT:OPER:PROT:NTR	272
PCC:POL	249	STAT:OPER:PROT:PTR	272
		OPERation:TESTing Status Register	273
[SOURCE:]PD command	250	STAT:OPER:TEST	274
PD:VOLT	250	STAT:OPER:TEST:COND	274
PD:VOLT:FREQ	250	STAT:OPER:TEST:ENAB	274
PD:VOLT:PATT	251	STAT:OPER:TEST:NTR	275
PD:VOLT:PROT	251	STAT:OPER:TEST:PTR	275
PD:VOLT:SEC	252	QUESTIONable status register	276
PD:VOLT:SEC:SWE:FALL:TIM	252	STAT:QUES	277
PD:VOLT:SEC:TIM	253	STAT:QUES:COND	277
PD:VOLT:SEC:TIM:STAT	253		
PD:VOLT:STEP	254		

STAT:QUES:ENAB	277	SYST:CONF:PON:STAT	300
STAT:QUES:NTR	278	SYST:CONF:SIO:JUDG:STAT	300
STAT:QUES:PTR	278	SYST:CONF:SLPR:STAT	301
Preset status	279	SYST:CONF:SOUT:FAIL:LOW:STAT ..	301
STAT:PRES	279	SYST:CONF:SOUT:FAIL:UPP:STAT ..	302
SYSTem Command.....	280	SYST:CONF:SOUT:HVON:STAT	302
SYST:BEEP	280	SYST:CONF:SOUT:PASS:STAT	303
SYST:BEEP:KEY	281	SYST:CONF:SOUT:PON:STAT	303
SYST:BEEP:PROT	281	SYST:CONF:SOUT:PROT:STAT	304
SYST:BEEP:SCPI	282	SYST:CONF:SOUT:READ:STAT	304
SYST:COMM:PROT:WDOG	283	SYST:CONF:SOUT:TEST:STAT	305
SYST:COMM:PROT:WDOG:DEL	283	TRIGger Command.....	306
SYST:COMM:RLST	284	TRIG:ACQ	306
SYST:DATE	285	TRIG:ACQ:COUN	306
SYST:ERR	286	TRIG:ACQ:DEL	307
SYST:ERR:COUN	287	TRIG:ACQ:SOUR	308
SYST:KLOC	287	TRIG:TEST	308
SYST:KLOC:LEV	288	TRIG:TEST:SOUR	309
SYST:PASS	289	Tutorial.....	310
SYST:PASS:CDIS	289	Withstanding voltage and insulation	
SYST:PASS:NEW	290	resistance test settings	310
SYST:PASS:STAT	290	Earth continuity test (EC) settings	315
SYST:LOC/ SYST:REM/ SYST:RWL ..	291	Partial discharge (PD) settings	318
SYST:SEC:IMM	291	Leakage current test settings.....	320
SYST:SSAV	292	Trigger Subsystem.....	324
SYST:SSAV:DEL	292	Executing tests	325
SYST:TIME	293	Configuring and executing auto tests	328
SYST:TIME:ADJ	293	Querying measured values.....	333
SYST:TZON	294	Querying test results.....	339
SYST:TZON:CAT	294	Waiting for Operation Complete	344
SYST:VERS	295	Status Monitoring.....	345
SYSTem:CONFigure Command	296	Error Checking.....	347
SYST:CONF:BEEP:VOL	296	When using commands on a PLC	
SYST:CONF:BEEP:VOL:PASS	296	(sequencer, controller).....	348
SYST:CONF:CAL:DUE:CONT	297	Visual Basic 2017	349
SYST:CONF:CAL:PROT:STAT	297	Appendix	353
SYST:CONF:DACT:STAT	298	List of Errors	353
SYST:CONF:FMOD:STAT	298	Command processing time	357
SYST:CONF:MOM:STAT	299	Legacy Commands.....	358
SYST:CONF:PHOL	299		

Command List

IEEE 488.2 common commands

*CLS

Clears all event registers including the status byte, event status, and error queue.

*ESE

Sets the event status enable register that is counted by the event summary bit (ESB) of the status byte.

*ESR

Queries the event status register.

*IDN

Queries the model name and firmware version of the product.

*OPC

Sets the OPC bit (bit 0) of the event status register when all the commands that are in standby have been processed.

*OPT

Queries the options that are installed in the product.

*PSC

Sets whether the event status enable register and service request enable register are cleared when the POWER switch is turned on.

*RCL

Recalls memory content.

*RST

Resets the panel settings (see the table below).

*SAV

Saves the panel settings to the setup memory.

*SRE

Sets the service request enable register.

*STB

Queries the contents of the status byte register and the MSS (master summary status) message.

***TRG**

Trigger command.

***TST**

Executes a self-test.

***WAI**

Prevents the device from executing subsequent commands until all operations that are in standby have completed.

ABORt Command

ABOR

Aborts measurements, tests, and other operations in all trigger subsystems (ACQuire, TEST).

ABOR:ACQ

Aborts measurement operations.

ABOR:TEST

Stops the ongoing test. Clears the protection/ fail mode.

CALCulate Command

CALC:SCAL:OFFS:AUTO

Sets whether to automatically set the offset before testing.

CALC:ACW Command

CALC:ACW:SCAL

Sets whether to offset the current running through the stray capacitance in AC withstanding voltage tests.

CALC:ACW:SCAL:OFFS

Sets the real part of the offset current in AC withstanding voltage tests.

CALC:ACW:SCAL:OFFS:IMAG

Sets the imaginary part of the offset current in AC withstanding voltage tests.

CALC:DCW Command

CALC:DCW:SCAL

Sets whether to offset the current running through the stray capacitance in DC withstanding voltage tests.

CALC:DCW:SCAL:OFFS

Sets the offset current for DC withstanding voltage tests.

CALC:EC Command

CALC:EC:SCAL

Sets whether to offset the voltage drop caused by the contact resistance in earth continuity tests (AC).

CALC:EC:SCAL:OFFS

Sets the offset resistance for earth continuity tests (AC).

CALC:EC:DC:SCAL

Sets whether to offset the voltage drop caused by the contact resistance in earth continuity tests (DC).

CALC:EC:DC:SCAL:OFFS

Sets the offset resistance for earth continuity tests (DC).

CALC:IR Command

CALC:IR:SCAL

Sets whether to offset the resistance applied to the stray capacitance in insulation resistance tests.

CALC:IR:SCAL:OFFS

Sets the offset resistance for insulation resistance tests.

CALC:MET Command

CALC:MET:SCAL

Sets whether to offset the current in meter mode.

CALC:MET:SCAL:OFFS

Sets the offset current for meter mode.

CALC:PAT Command

CALC:PAT:SCAL

Sets whether to offset the current in patient leakage current tests.

CALC:PAT:SCAL:OFFS

Sets the offset current for patient leakage current tests.

CALC:PAT:SCAL:CONV

Sets whether to convert the current with the specified voltage in patient leakage current tests.

CALC:PAT:SCAL:CONV:VOLT

Sets the conversion voltage for patient leakage current tests.

CALC:PCC Command

CALC:PCC:SCAL

Sets whether to offset the current in protective conductor current tests.

CALC:PCC:SCAL:OFFS

Sets the offset current for protective conductor current tests.

CALC:PCC:SCAL:CONV

Sets whether to convert the current with the specified voltage in protective conductor current tests.

CALC:PCC:SCAL:CONV:VOLT

Sets the conversion voltage for protective conductor current tests.

CALC:PD Command

CALC:PD:PREC

Sets the calibration of a discharge electric charge in partial discharge tests.

CALC:PD:PREC:EXEC

Executes calibration in partial discharge tests.

CALC:PD:PREC:STAT

Returns the state of calibration in partial discharge tests.

CALC:PD:VOLT:EXT:THR

Sets the electric charge to judge the discharge extinction voltage in partial discharge tests.

CALC:PD:VOLT:INC:THR

Sets the electric charge to judge the discharge inception voltage in partial discharge tests.

CALC:TC Command

CALC:TC:SCAL

Sets whether to offset the current in touch current tests.

CALC:TC:SCAL:OFFS

Sets the offset current for touch current tests.

CALC:TC:SCAL:CONV

Sets whether to convert the current with the specified voltage in touch current tests.

CALC:TC:SCAL:CONV:VOLT

Sets the conversion voltage for touch current tests.

DATA Command

DATA:BSIZ

Sets the buffer size (maximum number of measurement data recordings) of the data logger.

DATA:FORM

Sets the response format to use when measurement data is queried.

DATA:POIN

Queries the number of measurements recorded in the data logger.

DATA:REM

Queries the measurement data recorded in the data logger.

Display Command

DISP:ACW:CURR:PHOL

Displays the maximum current measurement from the start of the test in AC withstanding voltage tests.

DISP:DCW:CURR:PHOL

Displays the maximum current measurement from the start of the test in DC withstanding voltage tests.

DISP:EC:AC:CURR:PHOL

Displays the maximum resistance measurement from the start of the test in earth continuity tests (AC).

DISP:EC:DC:CURR:PHOL

Displays the maximum resistance measurement from the start of the test in earth continuity tests (DC).

DISP:IR:RES:PHOL

Displays the minimum resistance measurement from the start of the test in insulation resistance tests.

DISP:PAT:CURR:PHOL

Displays the maximum current measurement from the start of the test in patient leakage current tests.

DISP:PCC:CURR:PHOL

Displays the maximum current measurement from the start of the test in protective conductor current tests.

DISP:PD:COUL:PHOL

Sets whether to display the maximum value of electric charges that have been measured from the start of a partial discharge test.

DISP:TC:CURR:PHOL

Displays the maximum current measurement from the start of the test in touch current tests.

GRAPh Command

GRAP:PD:FORM

Sets variables to be represented on the axes of a graph in partial discharge tests.

GRAP:PD:MARK

Sets whether to display the markers for discharge inception voltage and discharge extinction voltage in partial discharge tests.

GRAP:PD:SCAL

Sets the display method for the graph scale in partial discharge tests.

HCOPy Command

HCOP:SDUM:DATA

Retrieves the screen capture of the present screen.

INITiate Command

INIT

Invalidates the present measurement data (data logger) and starts a new measurement.

INIT:ACQ

Invalidates the present measured data (data logger) and starts a new measurement.

INIT:TEST

Starts the test trigger function.

MEASure/READ/FETCh Command

FETC/ READ/ MEAS

Queries the measurement data in the order specified by DATA:FORM.

FETC:CIM/ READ:CIM/ MEAS:CIM

Queries the imaginary part of the current.

FETC:COUL/ READ:COUL/ MEAS:COUL

Queries the electric charge.

FETC:CRE/ READ:CRE/ MEAS:CRE

Queries the real part of the current.

FETC:CURR/ READ:CURR/ MEAS:CURR

Queries the current.

FETC:ETIM/ READ:ETIM/ MEAS:ETIM

Queries the elapsed test time.

FETC:RES/ READ:RES/ MEAS:RES

Queries the resistance.

FETC:VOLT/ READ:VOLT/ MEAS:VOLT

Queries the voltage.

OUTPut Command

OUTP

Sets wheter to output the temporary voltage in leakage current (TC/PCC/Patient) tests.

OUTP:110P

Sets whether to output the voltage applied from the 110% terminal to the AC LINE IN inlet in meter tests.

OUTP:110P:POL

Sets the polarity of the voltage applied from the 110 % terminal in meter tests.

PROG Command

PROG

Sets the program to be edited.

PROG:CRE

Creates a new program.

PROG:DEL

Deletes a program.

PROG:INT:TIM

Sets the step interval time.

PROG:FAIL:COUT

Sets the operation to be executed when a fail judgment occurs.

PROG:LIST

Queries stored programs.

PROG:OUTP:CONT

Sets the power supply method after the completion of a step.

PROG:REN

Changes the name of the selected program.

PROG:SAVE

Saves the selected program.

PROG:STEP<n>:<prog_item>

Sets the test condition indicated by <prog-item> to step n of the selected program.

PROG:STEPS:COUN

Sets the number of steps of the selected program.

RESult command

RES:FORM

Sets the response format to use when test results are queried.

RES

Queries the previous test result.

RES:COUN

Queries the number of test results stored in the product.

RES:REM

Queries the oldest test result.

RES:TZON

Sets a test result time in UTC or time in the time zone specified by SYST:TZON.

ROUTe Command

ROUT:ACW:TERM

Sets the connection of each channel of the scanner in AC withstanding voltage tests.

ROUT:ACW:TERM:CCH

Sets the continuity check for the test leads connected to the scanner and the EUT in AC withstanding voltage tests.

ROUT:CAT

Queries the available scanner channels.

ROUT:DCW:TERM

Sets the connection of each channel of the scanner in DC withstanding voltage tests.

ROUT:DCW:TERM:CCH

Sets the continuity check for the test leads connected to the scanner and the EUT in DC withstanding voltage tests.

ROUT:IR:TERM

Sets the connection of each channel of the scanner in insulation resistance tests.

ROUT:IR:TERM:CCH

Sets the continuity check for the test leads connected to the scanner and the EUT in insulation resistance tests.

ROUT:TERM:CONT:FAIL

Returns the channel(s) encountering Contact-FAIL.

SAMPle command

SAMP:COUN

Sets the number of measured value samples you want to obtain.

SAMP:TEST:ENAB

Sets whether to obtain measurement samples even while the test is not performed.

SAMP:TIM

Sets a sampling interval.

SENSe:ACW Command

SENS:ACW:CURR:FILT:HPAS

Sets the high-pass filter for AC withstanding voltage tests.

SENS:ACW:CURR:FILT:LPAS

Sets the low-pass filter for AC withstanding voltage tests.

SENS:ACW:CURR:FILT:TYPE

Sets the filter type for AC withstanding voltage tests.

SENS:ACW:CURR:MODE

Sets the current measurement mode in AC withstanding voltage tests.

SENS:ACW:JUDG

Sets the reference current for upper limit judgment in AC withstanding voltage tests.

SENS:ACW:JUDG:LOW

Sets the reference current for the lower limit judgment in AC withstanding voltage tests.

SENS:ACW:JUDG:LOW:STAT

Sets whether to judge with the lower limit in AC withstanding voltage tests.

SENS:ACW:TERM:GRO

Sets whether to measure by including or excluding the current running through the stray capacitance in AC withstanding voltage tests.

SENS:ACW:VOLT:MODE

Sets the voltage measurement mode in AC withstanding voltage tests.

SENSe:DCW Command

SENS:DCW:CURR:FILT:HPAS

Sets the high-pass filter for DC withstanding voltage tests.

SENS:DCW:CURR:FILT:LPAS

Sets the low-pass filter for DC withstanding voltage tests.

SENS:DCW:CURR:FILT:TYPE

Sets the filter type for DC withstanding voltage tests.

SENS:DCW:JUDG

Sets the reference current for upper limit judgment in DC withstanding voltage tests.

SENS:DCW:JUDG:DEL

Sets the delay time until starting upper limit judgment in DC withstanding voltage tests.

SENS:DCW:JUDG:DEL:AUTO

Sets whether to make the judgment delay automatic in DC withstanding voltage tests.

SENS:DCW:JUDG:LOW

Sets the reference current for the lower limit judgment in DC withstanding voltage tests.

SENS:DCW:JUDG:LOW:STAT

Sets whether to judge with the lower limit in DC withstanding voltage tests.

SENS:DCW:TERM:GRO

Sets whether to measure by including or excluding the current running through the stray capacitance in DC withstanding voltage tests.

SENS:DCW:VOLT:MODE

Sets the voltage measurement mode in DC withstanding voltage tests.

SENSe:EC Command

SENS:EC:JUDG

Sets the reference resistance for upper limit judgment in earth continuity tests (AC).

SENS:EC:JUDG:STAT

Sets whether to judge with the upper resistance limit in earth continuity tests (AC).

SENS:EC:JUDG:LOW

Sets the reference resistance for lower limit judgment in earth continuity tests (AC).

SENS:EC:JUDG:LOW:STAT

Sets whether to judge with the lower resistance limit in earth continuity tests (AC).

SENS:EC:JUDG:TYPE

Sets whether to use resistance or voltage to make upper limit judgment and lower limit judgment in earth continuity tests (AC).

SENS:EC:JUDG:VOLT

Sets the reference voltage for upper limit judgment in earth continuity tests (AC).

SENS:EC:JUDG:VOLT:STAT

Sets whether to judge with the upper voltage limit in earth continuity tests (AC).

SENS:EC:JUDG:VOLT:LOW

Sets the reference voltage for lower limit judgment in earth continuity tests (AC).

SENS:EC:JUDG:VOLT:LOW:STAT

Sets whether to judge with the lower voltage limit in earth continuity tests (AC).

SENS:EC:TERM:CCH

Sets the contact check for the test leads and the EUT in earth continuity tests (AC).

SENS:EC:TERM:WIRE

Sets the test lead wiring method in earth continuity tests (AC).

SENS:EC:DC:JUDG

Sets the reference resistance for upper limit judgment in earth continuity tests (DC).

SENS:EC:DC:JUDG:STAT

Sets whether to judge with the upper resistance limit in earth continuity tests (DC).

SENS:EC:DC:JUDG:LOW

Sets the reference resistance for lower limit judgment in earth continuity tests (DC).

SENS:EC:DC:JUDG:LOW:STAT

Sets whether to judge with the lower resistance limit in earth continuity tests (DC).

SENS:EC:DC:JUDG:TYPE

Sets whether to use resistance or voltage to make upper limit judgment and lower limit judgment in earth continuity tests (DC).

SENS:EC:DC:JUDG:VOLT

Sets the reference voltage for upper limit judgment in earth continuity tests (DC).

SENS:EC:DC:JUDG:VOLT:STAT

Sets whether to judge with the upper voltage limit in earth continuity tests (DC).

SENS:EC:DC:JUDG:VOLT:LOW

Sets the reference voltage for lower limit judgment in earth continuity tests (DC).

SENS:EC:DC:JUDG:VOLT:LOW:STAT

Sets whether to judge with the lower voltage limit in earth continuity tests (DC).

SENS:EC:DC:TERM:CCH

Sets the continuity check for the test leads and the EUT in earth continuity tests (DC).

SENS:EC:DC:TERM:WIRE

Sets the test lead wiring method in earth continuity tests (DC).

SENSe:IR Command

SENS:IR:CURR:FILT:LPAS:STAT

Enables or disables the low-pass filter for insulation resistance tests.

SENS:IR:JUDG

Sets the reference resistance for upper limit judgment in insulation resistance tests.

SENS:IR:JUDG:STAT

Sets whether to judge with the upper resistance limit in insulation resistance tests.

SENS:IR:JUDG:CURR

Sets the reference current for upper limit judgment in insulation resistance tests.

SENS:IR:JUDG:CURR:STAT

Sets whether to judge with the upper current limit in insulation resistance tests.

SENS:IR:JUDG:CURR:LOW

Sets the reference current for lower limit judgment in insulation resistance tests.

SENS:IR:JUDG:CURR:LOW:STAT

Sets whether to judge with the lower current limit in insulation resistance tests.

SENS:IR:JUDG:DEL

Sets the time until starting upper limit judgment.

SENS:IR:JUDG:DEL:AUTO

Sets whether to make the judgment delay automatic.

SENS:IR:JUDG:LOW

Sets the reference resistance for lower limit judgment in insulation resistance tests.

SENS:IR:JUDG:LOW:STAT

Sets whether to judge with the lower resistance limit in insulation resistance tests.

SENS:IR:JUDG:TYPE

Sets whether to use resistance or current to make upper limit judgment and lower limit judgment in insulation resistance tests.

SENS:IR:TERM:GRO

Sets whether to measure by including or excluding the current running through the stray capacitance in insulation resistance tests.

SENSe:MET Command

SENS:MET:CURR:MODE

Sets the current measurement mode in meter mode.

SENS:MET:NETW

Sets the measurement circuit network to use in meter mode.

SENS:MET:RANG

Sets the meter mode measurement range.

SENS:MET:RANG:AUTO

Sets whether to set the meter mode measurement range to auto.

SENS:MET:SELV

Sets the SELV voltage of meter mode.

SENS:MET:SELV:STAT

Sets whether the SELV voltage is used.

SENS:MET:TERM

Sets the touch mode of meter mode.

SENSe:PAT Command

SENS:PAT:BAND

Sets whether to expand the band of the internal voltmeter of this product in patient leakage current tests.

SENS:PAT:COND

Sets the single fault condition for patient leakage current tests.

SENS:PAT:COND:FAUL

Sets the disconnected condition at fault for patient leakage current tests.

SENS:PAT:CURR:MODE

Sets the current measurement mode in patient leakage current tests.

SENS:PAT:JUDG

Sets the reference current for upper limit judgment in patient leakage current tests.

SENS:PAT:JUDG:STAT

Sets whether to judge with the upper current limit in patient leakage current tests.

SENS:PAT:JUDG:DEL

Set the time until starting judgments in patient leakage current tests.

SENS:PAT:JUDG:DEL:STAT

Sets whether to set the judgment delay in patient leakage current tests.

SENS:PAT:JUDG:LOW

Sets the reference current for lower limit judgment in patient leakage current tests.

SENS:PAT:JUDG:LOW:STAT

Sets whether to judge with the lower current limit in patient leakage current tests.

SENS:PAT:NETW

Sets the measurement circuit network that is compatible with the patient leakage current test standard.

SENS:PAT:NETW:PROB

Sets the B terminal probe connection destination for patient leakage current tests.

SENS:PAT:NETW:PROB:A

Queries the A terminal probe connection destination in patient leakage current tests.

SENS:PAT:RANG:AUTO

Sets the measurement range for patient leakage current tests.

SENS:PAT:TIM

Sets the test time for patient leakage current tests.

SENS:PAT:TIM:STAT

Sets whether to set the test time in patient leakage current tests.

SENSe:PCC Command

SENS:PCC:BAND

Sets whether to expand the band of the internal voltmeter of this product in protective conductor current tests.

SENS:PCC:COND

Sets the single fault mode for protective conductor current tests.

SENS:PCC:COND:FAUL

Queries the disconnected condition at fault for protective conductor current tests.

SENS:PCC:CURR:MODE

Sets the current measurement mode in protective conductor current tests.

SENS:PCC:JUDG

Sets the reference current for upper limit judgment in protective conductor current tests.

SENS:PCC:JUDG:STAT

Sets whether to judge with the upper current limit in protective conductor current tests.

SENS:PCC:JUDG:DEL

Sets the time until starting judgments in protective conductor current tests.

SENS:PCC:JUDG:DEL:STAT

Sets whether to set the judgment delay in protective conductor current tests.

SENS:PCC:JUDG:LOW

Sets the reference current for lower limit judgment in protective conductor current tests.

SENS:PCC:JUDG:LOW:STAT

Sets whether to judge with the lower current limit in protective conductor current tests.

SENS:PCC:NETW

Sets the measurement circuit network to use in protective conductor current tests.

SENS:PCC:RANG:AUTO

Sets the measurement range for protective conductor current tests.

SENS:PCC:TIM

Sets the test time for protective conductor current tests.

SENS:PCC:TIM:STAT

Sets whether to set the test time in protective conductor current tests.

SENSe:PD command

SENS:PD:FILT:BPAS

Sets the bandwidth for partial discharge tests.

SENS:PD:FILT:LPAS:STAT

Sets the low-pass filter for partial discharge tests.

SENS:PD:JUDG

Sets the reference discharge electric charge for upper limit judgment in partial discharge tests.

SENS:PD:JUDG:STAT

Sets whether to judge with the upper limit of discharge electric charge in partial discharge tests.

SENS:PD:JUDG:PCO

Sets the upper limit number of times the electric charge exceeds its threshold in partial discharge tests.

SENS:PD:JUDG:PCO:STAT

Sets whether to judge based on the upper limit number of times the electric charge exceeds its threshold in partial discharge tests.

SENS:PD:PCO:THR

Sets the electric charge threshold for partial discharge tests.

SENS:PD:RANG

Sets the measurement range in partial discharge tests.

SENS:PD:VOLT:MODE

Sets the voltage measurement mode in partial discharge tests.

SENSe:TC Command

SENS:TC:BAND

Sets whether to expand the band of the internal voltmeter of this product in touch current tests.

SENS:TC:COND

Sets the single fault condition for touch current tests.

SENS:TC:COND:FAUL

Sets the disconnected condition at fault for touch current tests.

SENS:TC:CURR:MODE

Sets the current measurement mode in touch current tests.

SENS:TC:JUDG

Sets the reference current for upper limit judgment in touch current tests.

SENS:TC:JUDG:STAT

Sets whether to judge with the upper current limit in touch current tests.

SENS:TC:JUDG:DEL

Set the time until starting judgments in touch current tests.

SENS:TC:JUDG:DEL:STAT

Sets whether to set the judgment delay in touch current tests.

SENS:TC:JUDG:LOW

Sets the reference current for lower limit judgment in touch current tests.

SENS:TC:JUDG:LOW:STAT

Sets whether to judge with the lower current limit in touch current tests.

SENS:TC:NETW

Sets the measurement circuit network to use in touch current tests.

SENS:TC:NETW:PROB

Sets the B terminal probe connection destination for touch current tests.

SENS:TC:NETW:PROB:A

Queries the A terminal probe connection destination in touch current tests.

SENS:TC:RANG:AUTO

Sets the measurement range for touch current tests.

SENS:TC:TIM

Sets the test time for touch current tests.

SENS:TC:TIM:STAT

Sets whether to set the test time in touch current tests.

[SOURce:] command

FUNC

Set the test mode.

[SOURce:]ACW Command

ACW:VOLT

Sets the test voltage for AC withstanding voltage tests.

ACW:VOLT:END:STAT

Sets the terminating voltage for AC withstanding voltage tests.

ACW:VOLT:FREQ

Sets the test voltage frequency for AC withstanding voltage tests.

ACW:VOLT:PROT

Sets the limit voltage for AC withstanding voltage tests.

ACW:VOLT:STAR

Sets the start voltage as a percentage for AC withstanding voltage tests.

ACW:VOLT:STAR:STAT

Sets whether to set the start voltage for AC withstanding voltage tests.

ACW:VOLT:SWE:FALL:TIM

Sets the voltage fall time for AC withstanding voltage tests.

ACW:VOLT:SWE:FALL:TIM:STAT

Sets whether to set the voltage fall time for AC withstanding voltage tests.

ACW:VOLT:SWE:TIM

Sets the voltage rise time for AC withstanding voltage tests.

ACW:VOLT:TIM

Sets the test time for AC withstanding voltage tests.

ACW:VOLT:TIM:STAT

Sets whether to set the test time for AC withstanding voltage tests.

[SOURce:]DCW Command

DCW:VOLT

Sets the test voltage for DC withstanding voltage tests.

DCW:VOLT:DISC:INT:STAT

Sets whether to discharge when interlock is activated in DC withstanding voltage tests.

DCW:VOLT:DISC:TIM

Sets the discharge time for DC withstanding voltage tests.

DCW:VOLT:END:STAT

Sets the terminating voltage for DC withstanding voltage tests.

DCW:VOLT:PROT

Sets the limit voltage for DC withstanding voltage tests.

DCW:VOLT:STAR

Sets the start voltage as a percentage for DC withstanding voltage tests.

DCW:VOLT:STAR:STAT

Sets whether to set the start voltage for DC withstanding voltage tests.

DCW:VOLT:SWE:FALL:TIM

Sets the voltage fall time for DC withstanding voltage tests.

DCW:VOLT:SWE:FALL:TIM:STAT

Sets whether to set the voltage fall time for DC withstanding voltage tests.

DCW:VOLT:SWE:TIM

Sets the voltage rise time for DC withstanding voltage tests.

DCW:VOLT:TIM

Sets the test time for DC withstanding voltage tests.

DCW:VOLT:TIM:STAT

Sets whether to set the test time for DC withstanding voltage tests.

[SOURce:]EC Command

EC:AC:CURR

Sets the test current for earth continuity tests (AC).

EC:AC:CURR:PROT

Sets the limit current for earth continuity tests (AC).

EC:AC:CURR:SWE:FALL:TIM

Sets the current fall time for earth continuity tests (AC).

EC:AC:CURR:SWE:FALL:TIM:STAT

Sets whether to set the current fall time for earth continuity tests (AC).

EC:AC:CURR:SWE:TIM

Sets the current rise time for earth continuity tests (AC).

EC:AC:CURR:TIM

Sets the test time for earth continuity tests (AC).

EC:AC:CURR:TIM:STAT

Sets whether to set the test time for earth continuity tests (AC).

EC:CURR:FREQ

Sets the test current frequency for earth continuity tests (AC).

EC:DC:CURR

Sets the test current for earth continuity tests (DC).

EC:DC:CURR:PROT

Sets the limit current for earth continuity tests (DC).

EC:DC:CURR:SWE:FALL:TIM

Sets the current fall time for earth continuity tests (DC).

EC:DC:CURR:SWE:FALL:TIM:STAT

Sets whether to set the current fall time for earth continuity tests (DC).

EC:DC:CURR:SWE:TIM

Sets the current rise time for earth continuity tests (DC).

EC:DC:CURR:TIM

Sets the test time for earth continuity tests (DC).

EC:DC:CURR:TIM:STAT

Sets whether to set the test time for earth continuity tests (DC).

[SOURce:]IR command

IR:TERM:POL

Queries the polarity of the power supplied to the output terminals in insulation resistance tests.

IR:VOLT

Sets the test voltage for insulation resistance tests.

IR:VOLT:DISC:INT:STAT

Sets whether to discharge when interlock is activated in insulation resistance tests.

IR:VOLT:DISC:TIM

Sets the discharge time for insulation resistance tests.

IR:VOLT:PROT

Sets the limit voltage for insulation resistance tests.

IR:VOLT:RANG

Sets the output voltage range for insulation resistance tests.

IR:VOLT:STAR

Sets the start voltage as a percentage for insulation resistance tests.

IR:VOLT:STAR:STAT

Sets whether to set the start voltage for insulation resistance tests.

IR:VOLT:SWE:TIM

Sets the voltage rise time for insulation resistance tests.

IR:VOLT:TIM

Sets the test time for insulation resistance tests.

IR:VOLT:TIM:STAT

Sets whether to set the test time for insulation resistance tests.

[SOURce:]PATient Command

PAT:110P:OUTP

Sets whether to apply the voltage applied from the 110% terminal to the AC LINE IN inlet in patient leakage current tests.

PAT:110P:POL

Sets the polarity of the voltage applied from the 110% terminal in patient leakage current tests.

PAT:POL

Sets the polarity of the power supply line supplied to the EUT for patient leakage current tests.

[SOURce:]PCC Command

PCC:POL

Sets the polarity of the power supply line for protective conductor current tests.

[SOURce:]PD command

PD:VOLT

Sets the test voltage for partial discharge tests.

PD:VOLT:FREQ

Sets the frequency for partial discharge tests.

PD:VOLT:PATT

Sets the voltage pattern for partial discharge tests.

PD:VOLT:PROT

Sets the limit voltage for partial discharge tests.

PD:VOLT:SEC

Sets the 2nd test voltage for partial discharge tests.

PD:VOLT:SEC:SWE:FALL:TIM

Sets the 2nd voltage fall time for partial discharge tests.

PD:VOLT:SEC:TIM

Sets the 2nd test time for partial discharge tests.

PD:VOLT:SEC:TIM:STAT

Enables or disables the 2nd test time for partial discharge tests.

PD:VOLT:STEP

Sets the step voltage for partial discharge tests.

PD:VOLT:STEP:TIM

Sets the step time for partial discharge tests.

PD:VOLT:SWE:FALL:TIM

Sets the voltage fall time for partial discharge tests.

PD:VOLT:SWE:FALL:TIM:STAT

Enables or disables the voltage fall time for partial discharge tests.

PD:VOLT:SWE:TIM

Sets the voltage rise time for partial discharge tests.

PD:VOLT:TIM

Sets the test time for partial discharge tests.

PD:VOLT:TIM:STAT

Enables or disables the test time for partial discharge tests.

[SOURce:]TC Command

TC:110P:OUTP

Sets whether to apply the voltage applied from the 110% terminal to the AC LINE IN inlet in touch current tests.

TC:110P:POL

Sets the polarity of the voltage applied from the 110% terminal in touch current tests.

TC:POL

Sets the polarity of the power supply line supplied to the EUT for touch current tests.

STATus Command

STAT:OPER

Queries the event of the OPERation status register.

STAT:OPER:<bit-item>

Queries the event of the specified bit in the OPERation status register bits.

STAT:OPER:COND

Queries the condition of the OPERation status register.

STAT:OPER:COND:<bit-item>

Queries the status of the specified bit in the OPERation status register bits.

STAT:OPER:ENAB

Sets the enable register of the OPERation status register.

STAT:OPER:ENAB:<bit-item>

Sets the enable register of the specified bit in the OPERation status register.

STAT:OPER:NTR

Sets the negative transition filter of the OPERation status register.

STAT:OPER:NTR:<bit-item>

Sets the negative transition filter of the specified bit in the OPERation status register.

STAT:OPER:PTR

Sets the positive transition filter of the OPERation status register.

STAT:OPER:PTR:<bit-item>

Sets the positive transition filter of the OPERation status register.

STAT:OPER:PROT

Queries the event of the OPERation:PROTecting status register.

STAT:OPER:PROT:COND

Queries the condition of the OPERation:PROTecting status register.

STAT:OPER:PROT:ENAB

Sets the enable register of the OPERation:PROTecting status register.

STAT:OPER:PROT:NTR

Sets the negative transition filter of the OPERation:PROTecting status register.

STAT:OPER:PROT:PTR

Sets the positive transition filter of the OPERation:PROTecting status register.

STAT:OPER:TEST

Queries the event of the OPERation:TESTing status register.

STAT:OPER:TEST:COND

Queries the condition of the OPERation:TESTing status register.

STAT:OPER:TEST:ENAB

Sets the enable register of the OPERation:TESTing status register.

STAT:OPER:TEST:NTR

Sets the negative transition filter of the OPERation:TESTing status register.

STAT:OPER:TEST:PTR

Sets the positive transition filter of the OPERation:TESTing status register.

STAT:QUES

Queries the event of the QUEStionable status register.

STAT:QUES:COND

Queries the condition of the QUEStionable status register.

STAT:QUES:ENAB

Sets the enable register of the QUEStionable status register.

STAT:QUES:NTR

Sets the negative transition filter of the QUEStionable status register.

STAT:QUES:PTR

Sets the positive transition filter of the QUESTIONable status register.

STAT:PRES

Resets the ENABLE, PTRansition, and NTRansition filter registers of all status registers (including sub registers) to their default values.

SYSTEM Command

SYST:BEEP

Turns all buzzers on and off.

SYST:BEEP:KEY

Turns on or off the buzzer that sounds when an invalid key is pressed.

SYST:BEEP:PROT

Turns on or off the buzzer that sounds when a protection function is activated.

SYST:BEEP:SCPI

Turns on or off the buzzer that sounds when an SCPI error occurs.

SYST:COMM:PROT:WDOG

Enables or disables the communication monitoring (WATCHDOG) timer.

SYST:COMM:PROT:WDOG:DEL

Sets the delay time of the communication monitoring (WATCHDOG) timer.

SYST:COMM:RLST

Switches the TOS93 to local or remote mode.

SYST:DATE

Sets the date.

SYST:ERR

Reads the oldest error information or event information from the error queue.

SYST:ERR:COUN

Returns the number of unread errors in the error queue.

SYST:KLOC

Sets or releases panel control lock.

SYST:KLOC:LEV

Sets the panel control lock level.

SYST:PASS

Enables a password-protected command.

SYST:PASS:CDIS

Disables the password-protected command.

SYST:PASS:NEW

Sets the password.

SYST:PASS:STAT

Queries the enabled/disabled state of the password-protected command.

SYST:LOC/ SYST:REM/ SYST:RWL

This is an old style command.

SYST:SEC:IMM

Sanitizes all contents stored in memory and initializes the panel settings to their factory default conditions.

SYST:SSAV

Enables or disables the screen saver.

SYST:SSAV:DEL

Sets the time until the screen saver starts.

SYST:TIME

Sets the time.

SYST:TIME:ADJ

Automatically synchronizes the system clock using the NTP server on the network.

SYST:TZON

Sets the time zone of the system clock.

SYST:TZON:CAT

Queries the time zone IDs that can be used.

SYST:VERS

Queries the version of the SCPI specifications that the product complies with.

SYSTem:CONFigure Command

SYST:CONF:BEEP:VOL

Sets the volume level of the buzzer that is sounded when a FAIL judgment occurs.

SYST:CONF:BEEP:VOL:PASS

Sets the volume level of the buzzer that is sounded when a PASS judgment occurs.

SYST:CONF:CAL:DUE:CONT

Sets the calibration period.

SYST:CONF:CAL:PROT:STAT

Sets whether to activate the protection function and switch to protection mode when the calibration period is expired.

SYST:CONF:DACT:STAT

Enables or disables the double action function.

SYST:CONF:FMOD:STAT

Enables or disables the fail mode.

SYST:CONF:MOM:STAT

Enables/disables momentary.

SYST:CONF:PHOL

Sets the length of time that a PASS judgment result will be held.

SYST:CONF:PON:STAT

Sets the condition panel setting state when the POWER switch is turned on.

SYST:CONF:SIO:JUDG:STAT

Turns on or off the judgment result output at STEP END of the SIGNAL I/O connector.

SYST:CONF:SLPR:STAT

Enables/disables the start long function.

SYST:CONF:SOUT:FAIL:LOW:STAT

Sets whether to output a signal from the STATUS OUT connector during "L-FAIL."

SYST:CONF:SOUT:FAIL:UPP:STAT

Sets whether to output a signal from the STATUS OUT connector during "U-FAIL."

SYST:CONF:SOUT:HVON:STAT

Sets whether to output a signal from the STATUS OUT connector while voltage is residing or while a test is in progress.

SYST:CONF:SOUT:PASS:STAT

Sets whether to output a signal from the STATUS OUT connector during "PASS."

SYST:CONF:SOUT:PON:STAT

Sets whether to output a signal from the STATUS OUT connector while the POWER switch is turned on.

SYST:CONF:SOUT:PROT:STAT

Sets whether to output a signal from the STATUS OUT connector during protection mode.

SYST:CONF:SOUT:READ:STAT

Sets whether to output a signal from the STATUS OUT connector during "READY."

SYST:CONF:SOUT:TEST:STAT

Sets whether to output a signal from the STATUS OUT connector while the test voltage is at the set value.

TRIGger Command

TRIG:ACQ

Executes a software trigger on the ACQ trigger subsystem.

TRIG:ACQ:COUN

Sets the trigger count of the ACQ trigger subsystem.

TRIG:ACQ:DEL

Sets the delay time from trigger application of the ACQ trigger subsystem until measured value recording.

TRIG:ACQ:SOUR

Sets the condition (trigger source) for actually starting the measurement after the ACQ trigger subsystem receives an INIT:ACQ.

TRIG:TEST

Executes a software trigger on the TEST trigger subsystem.

TRIG:TEST:SOUR

Sets the condition (trigger source) for actually starting the test after the TEST trigger subsystem receives an INIT:TEST.

Introduction

The TOS9300 Series Communication Interface Manual explains the settings that are used to control the TOS9300 series remotely through the following interfaces and the available commands.

- RS232C interface
- USB interface
- LAN interface

When the product is operating under remote control, REMOTE appears on the front panel display. To switch the product back to local mode from the front panel, press LOCAL.

For the safety precautions, installation, operation, and specifications of the product, read the accompanying TOS9300 Series User's Manual.

■ Reading environment

This manual is in PDF format. The following environments are recommended for reading this manual.

PDF Reader: Adobe Reader

■ Intended readers

This manual is written for readers with sufficient basic knowledge of how to control measuring instruments using a PC.

Familiarize yourself with the syntax of the SCPI commands that are used with the product before you use them.

■ Structure of the manual

This manual consists of the following sections.

- Overview
- Setup
- Message Overview
- Commands
- Tutorial
- Appendix

■ Trademarks

Microsoft Windows is a trademark of Microsoft Corporation in the United States and/or other countries.

All other company and product names used in this guide are trademarks or registered trademarks of their respective owners.

■ Firmware version of the product to which this manual applies

This manual applies to products with firmware versions 2.0x.

■ Measuring instrument interface standards

This product complies with the following standards.

- IEEE Std 488.2-1992 IEEE Standard Codes, Formats, Protocols, and Common Commands For Use With IEEE Std 488.1-1987
- IEEE Std 488.1-1987 IEEE Standard Digital Interface for Programmable Instrumentation
- Standard Commands for Programmable Instruments (SCPI) version 1999.0
- Universal Serial Bus Specification Rev 2.0
- Universal Serial Bus Test and Measurement Class Specification (USBTMC) Rev 1.0
- Universal Serial Bus Test and Measurement Class, Subclass USB488 Specification (USBTMC-USB488) Rev 1.0
- TCP/IP Instrument Protocol Specification VXI-11 Rev 1.0 1995
- TCP/IP-IEEE488.2 Interface Specification VXI-11.3 Draft 0.3 1995
- 1.5 LXI Device Specification 2016
- LXI HiSLIP Extended Function Rev 1.01
- IVI-6.1 IVI High-Speed LAN Instrument Protocol (HiSLIP) Rev 1.0
- VPP-4.3 The VISA Library 2015 Rev 5.5

■ Copyright

The contents of this manual may not be reproduced, in whole or in part, without the prior consent of the copyright holder.

The specifications of this product and the contents of this manual are subject to change without prior notice.

Copyright©2018 KIKUSUI ELECTRONICS Corp.

Setup

Installing the VISA Library

VISA (Virtual Instrument Software Architecture) was developed by the IVI Foundation. It is the standard specification for measurement instrument connection software.

To use the VISA library (VISA COM) with the I/O library, the VISA library must be installed on the controller (Windows).

You have to install one of the following VISA libraries (driver software that is implemented according to the VISA specifications).

- NI-VISA by NI Corporation (Ver. 5.1.1 or later)
- Keysight VISA (Keysight IO Libraries Suite 16.0 or later) by Keysight Technologies
- KI-VISA Ver. 5.0.4 or later

—Note—

- Depending on the interface, you may not be able to use your VISA library if it is an older version than that specified.
- Do not install multiple VISA libraries on the same PC. Doing so may cause errors.

Setting Up the Interface

The product is standard equipped with RS232C, USB, and LAN interfaces.

There is no need to switch interfaces. All interfaces can be used simultaneously. Each interface can be turned off using CONFIG settings.

RS232C

USB

LAN

Accessing and Operating the Product from a Web Browser (LAN)

WARNING

If the remote control via digital interface fails to work properly, an unexpected operation may occur that may cause electric shock, fire, physical damage to the DUT, and so on. If you are going to remotely control the TOS93 from a distance, take safety measures such as using a watchdog timer.

RS232C

■ RS232C connection

The RS232C port on the product side is D-sub 9-pin. Check that the product and your PC are off, and then connect them.

For the RS232C cable, use a D-sub, 9-pin, female-to-female AT crossover cable.

The following figure shows the connector pinout when you are facing the rear panel.

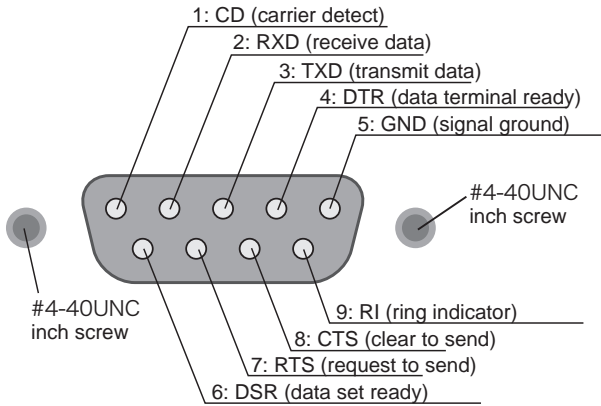

Viewing the front panel

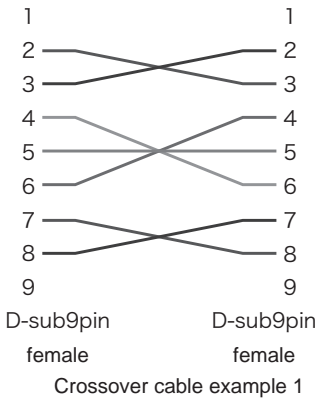

■ Protocol

The RS232C protocol is shown in the following table.

The underlined value is the factory default value.

Parameter	Value
Baudrate: Baud rate	9 600 bps/ <u>19 200 bps</u> / 38 400 bps/ 57 600 bps/ 115 200 bps
Data: Data length	8 bit (fixed)
Stop: Stop bits	1 bit (fixed)
Parity: Parity	None (fixed)
Flow Ctrl: Flow control	CTS/RTS, none

■ RS232C settings

For details, see the user's manual.

- 1** Press **SYSTEM > Interface**.
- 2** Press **Modify**, and use the rotary knob to select the parameter you want to change.
- 3** Press **Edit**, and then use the numeric keypad or the rotary knob to select the appropriate value.
Press **ENTER** to continue setting other parameters.
- 4** Press **Apply**.
A confirmation screen appears.
- 5** Press **ENTER**.
To cancel, use the rotary knob to select **NO**, and then press **ENTER**.

■ Break signal

The break signal is used as a substitute for the IEEE488.1 dcl/sdc (Device Clear, Selected Device Clear) message.

USB

To use the USB interface to control the product, a device driver that supports the USB Test & Measurement class (USBTMC) must be installed on the controller. The USBTMC driver is installed automatically by the VISA library.

■ USB connection

Connect the product to a PC using a USB cable. To prevent the USB cable from coming loose unexpectedly, fix the cable to the product using a cable tie.

1 Use the included cable tie to gently tie the cables as shown below.

The cable tie can be reused. Do not cut the extraneous portion of the tie.

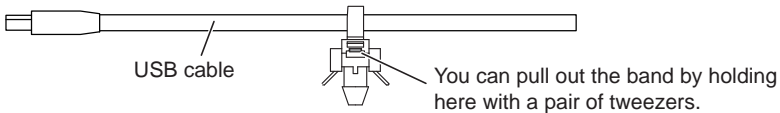

2 Attach the tip of the cable tie to the product as shown below.

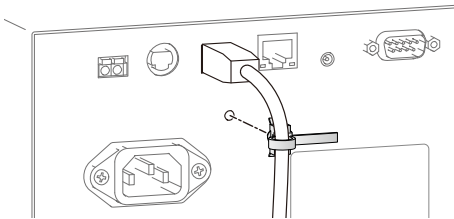

3 Firmly tighten the cable tie so that the USB cables do not come loose.

■ Service request

The product is equipped with service request and serial polling functions.

■ USB function

Complies with USB specification 2.0

Complies with USBTMC specification 1.0 and USBTMC-USB488 specification 1.0

Baud rate: 480 Mbps maximum (high speed)

VID (vendor ID)

0x0B3E

PID (product ID)

0x104F

LAN

To use the LAN interface to control the product, middleware that supports the SC-PI-Telnet, VXI-11, HiSLIP, or SCPI-RAW protocol is required. The middleware is installed automatically by the VISA library.

The LAN interface board has a Web browser interface (Web Browser Interface). You can configure the LAN interface settings from your PC's Web browser.

For information on topics such as connecting to your corporate LAN, your IP address, your host name, and security, contact your network administrator.

If you are using a host name (a Bonjour host name) in Windows7, you have to install Apple Bonjour.

■ LAN connection

Use a standard LAN cable (category 5 and straight) to connect the product to a network hub or router.

■ LAN settings

Normally, set “IP Address Method” to “Automatic” (factory default setting).

To set the IP address manually, set IP Address Method to Static, and then set the IP address.

For details, see the user’s manual.

- 1** Press **SYSTEM > Interface**.
- 2** Press **Modify**, and use the rotary knob to select the parameter you want to change.
- 3** Press **Edit**, and then use the numeric keypad or the rotary knob to select the appropriate value.
Press **ENTER** to continue setting other parameters.
- 4** Press **Apply**.
A confirmation screen appears.
- 5** Press **ENTER**.
The LAN interface restarts, and the settings are applied. To cancel, use the rotary knob to select **NO**, and then press **ENTER**.



WARNING

Possible damage to the equipment and electric shock. The LAN interface can be accessed from anywhere on the network that the product is connected to. Change the security settings if necessary. The security settings that you can apply are: password protection and IP address access control.

■ Service request

The product is equipped with service request and serial polling functions.

■ LAN function

Complies with LXI 1.5 Core 2016

Complies with the SCPI-Telnet, VXI-11, HiSLIP, and SCPI-RAW protocols

Baud rate: 100 Mbps maximum (auto negotiation)

AUTO MDIX

From your Web browser, you can:

Instrument information, network information, display of VISA resource information, checking the connected TOS9300, remote control from browser, changing network settings, license information, password setting

■ Restarting the LAN interface

You can use the SYSTEM settings to restart the LAN interface. Even if you restart the LAN interface, the settings that you have specified do not change. This operation does not affect the product's panel settings.

1 Press **SYSTEM > Interface**.

2 Press **Modify**.

3 Press **Apply**.
A confirmation screen appears.

4 Press **ENTER**.
The LAN interface restarts.

■ Resetting or Initializing the LAN interface

You can use the SYSTEM settings to reset or initialize the LAN settings.

When reset or initialized, network settings are changed as follows.

The items with an X mark are returned to their default values.

Reset	default values, resetting to	Parameter	Default value
X	X	IP Address Assignment	Auto
	X	DNS Server Assignment	0.0.0.0
	X	WINS Server Assignment	0.0.0.0
	X	Desired Hostname	Model name and serial number
	X	Desired Description	KIKUSUI XXXX Electrical Safety Analyzer (XXXX is the model name) and serial number
X	X	Enable Dynamic DNS	Enable
X	X	Enable mDNS	Enable
X	X	Enable NetBIOS Over TCP/IP	Enable
X	X	Password for the Web browser interface	Not set

Resetting

- 1** Press **SYSTEM > Interface**.
- 2** Press **Modify > LAN Reset**.
A confirmation screen appears.
- 3** Press **ENTER**.
The LAN interface settings are reset.

Returning to factory default settings (Initializing)

- 1** Press **SYSTEM > Interface**.
- 2** Press **Modify > Default**.
A confirmation screen appears.
- 3** Press **ENTER**.
The LAN interface settings are returned to their factory default settings.

Accessing and Operating the Product from a Web Browser (LAN)

You can configure the LAN interface settings from your PC's Web browser. Use the latest browser version.

The following browsers are supported.

- Google Chrome
- Microsoft Edge
- Safari

The website URL is the IP address with `http://` added in front of it.

Use SYSTEM settings to check the IP address, and enter the URL directly in the browser's address bar.

If a VISA library is in use, a function for searching the VXI-11 measurement instrument with the application supplied by the vendor (National Instruments NI-MAX, Keysight Connection Expert, Kikusui KI-VISA Instrument Explorer, or the like) is available. You can open the Web browser interface by simply searching for the instrument and clicking the Web link that appears in the search result.

Example: When the IP address is 169.254.7.8

`http://169.254.7.8`

Example: When the host name is TOS9303LC-12345

`http://TOS9303LC-12345.local`

■ WELCOME page

When you connect to the Web browser interface, a WELCOME page appears first. This page shows the measuring instrument information, network information, and VISA resource (I/O resource) information. Click the navigation menu to go to another page.

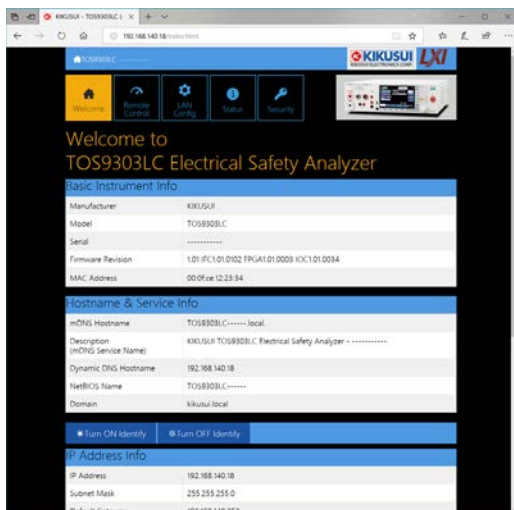

Turn ON Identify: “LXI Web Identify” appears in the front panel display of the connected TOS93. This allows you to identify the connected TOS93.

Turn OFF Identify: The displayed “LXI Web Identify” disappears.

■ Remote Control page

You can remotely control the TOS93 from a browser. The various buttons have the same functions as those on the front panel of the TOS93.

If you control the TOS93 from the Remote Control page, display updating slows down, but this does not affect the actual operation.

If you turn off the TOS93 while the Remote Control page is displayed, the settings will not be saved. To save the settings, close the browser, and then turn off the power.

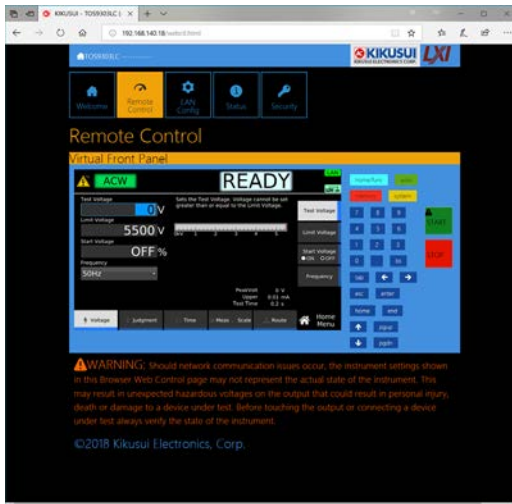

■ LAN Configuration page

You can display (View Mode) and change (Modify Mode) the network settings.

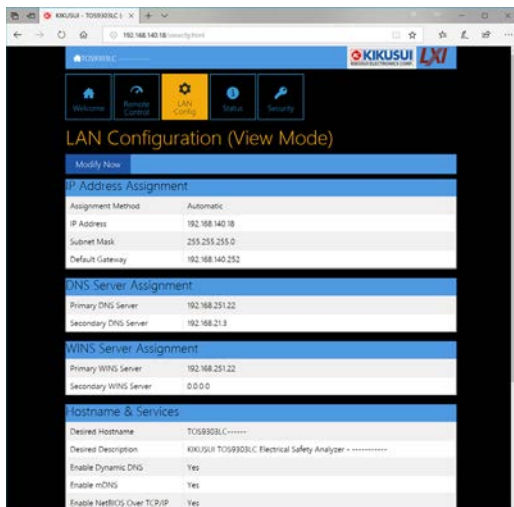

Navigation (View Mode)

Modify Now: Changes to the network setting edit screen (Modify Mode).

Navigation (Modify Mode)

Undo: Returns the edited contents to the state before editing.

Apply: Applies the edited contents.

Reset: Resets the network settings.

Default: Returns the network settings to the factory default settings.

Back to View Mode: Changes to the network setting view screen (View Mode).

IP Address Assignment

You can set the IP address. You can choose between automatic assignment and assignment of a fixed address.

In the case of automatic assignment of IP address, we recommend using the DHCP server function using a router as far as possible.

If the DHCP server function is not used, it takes about 60 seconds until determination that address assignment with DHCP has failed. Then, an address between 169.254.0.0 to 169.254.255.255 is assigned by link local address (Auto-IP).

DNS Server Assignment

Sets the address of the DNS server.

WINS Server Assignment

Sets the address of the WINS server.

Hostname & Services

You can set the host name and so on. If you set the host name, you can use it in place of the IP address to access the LAN interface. Normally, we recommend that you select “Enable Dynamic DNS”, “Enable mDNS”, and “Enable NetBIOS Over TCP/IP”.

If you leave the Hostname and Description boxes empty and click “Apply,” the host name will be created from the model name and serial number.

TCP Ports (View Mode)

The number of the TCP port in use is displayed. You cannot change the port number.

Reset and factory default settings

If you click Reset or Default, network settings are changed as follows.

The items with an X mark are returned to their default values.

Reset	Default	Item	Default value
X	X	IP Address Assignment	Automatic
X	X	DNS Server Assignment	0.0.0.0
X	X	WINS Server Assignment	0.0.0.0
	X	Desired Hostname	Model name and serial number
	X	Desired Description	KIKUSUI XXXX Electrical Safety Analyzer (XXXX is the model name) and serial number
X	X	Enable Dynamic DNS	Enable
X	X	Enable mDNS	Enable
X	X	Enable NetBIOS Over TCP/IP	Enable

■ System Status page

This page shows the system information and the license information of the open-source software.

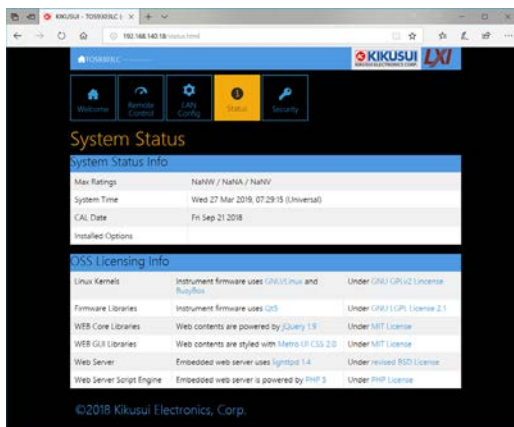

The screenshot shows the Kikusui TOS93 interface. At the top, there is a navigation bar with icons for Welcome, Remote Control, Easy Config, Status, and Security. The main content area is titled "System Status" and is divided into two sections: "System Status Info" and "OSS Licensing Info".

System Status Info

Max Ratings	NAHV / NAHA / NAHV	
System Time	Wed 27 Mar 2019, 07:29:15 (Universal)	
CAL Date	Fri Sep 21 2018	

Installed Options

OSS Licensing Info

Linux Kernel	Instrument firmware uses GNU/Linux and BusyBox	Under GPLv2 License
Firmware Libraries	Instrument firmware uses GDB	Under GPLv2 License 2.1
WEB Core Libraries	Web contents are powered by jQuery 1.8	Under MIT License
WEB GUI Libraries	Web contents are styled with Metro-UI CSS 2.0	Under MIT License
Web Server	Embedded web server uses Lighttpd 1.4	Under revised BSD License
Web Server Script Engine	Embedded web server is powered by PHP 5	Under PHP License

©2018 Kikusui Electronics, Corp.

■ Password Security page

You can set and change the password for the Web browser interface here.



When a password has been set, that password is required in order to use the following functions.

- Remote control from Remote Control page
- Editing of LAN Configuration page
- Changing/deleting the password

Set New Password

Enter the password (4 to 15 characters).

You can use alphanumeric characters, hyphens, and underscores for the password.

Changing or deleting the password

After the password has been set, the screen for changing the password appears when you enter the password.

To change the password, enter the present password in “Current Password”, enter the new password in “New Password” and “Confirm Password”, and then click “Apply”.

To disable password protection, enter the present password in “Current Password”, leave “New Password” and “Confirm Password” blank, and click “Apply”.

If you forget the password

If you forget the password, reset the LAN interface setting in the SYSTEM settings or initialize the product to its factory default settings.

About Commands

The information that is transferred between the controller (PC) and the device (TOS93 series) is referred to as messages.

This product uses the SCPI language for these messages.

The messages that the PC sends to the product are commands. The messages that the product sends to the PC are responses.

Command Hierarchy

SCPI is an ASCII-based command language that was designed for test and measuring equipment. The command structure is composed of the common roots and nodes that are the building blocks of the SCPI subsystem. A command consists of a program header, parameters, and punctuation marks.

The following table uses the SOURce subsystem as an example to explain the hierarchy.

Program header	Parameter	Node level
[SOUR]		Root node
:DCW		2nd level
:VOLT		3rd level
:STAR	<boolean>	4th level
:IR		2nd level
:VOLT		3rd level
:RANG	<character>	4th level
:STAR	<character>	4th level

A colon (:) separates a higher node from a lower node.

Command Syntax

—Note—

To use the communication interface, a “SYST:COMM:RLST REM” command must be sent to set the product to remote mode. To use remote programming, send “SYST:COMM:RLST REM” at the beginning of the program.

In this manual, SCPI commands are expressed in the following format.

```
[SOURCE:][ACW:]VOLTage[:LEVel][:IMMediate][:AMPLitude] <numeric>
```

SCPI commands are also available in the short form. In the short form, the lower-case characters in SCPI commands are omitted.

SCPI commands can be sent either in the long form or short form. Because SCPI commands are not case-sensitive, VOLT, Volt, and volt are all acceptable as short form notations. In the long form, VOLTAGE, Voltage, and voltage are all acceptable.

- A space separates a program header and its parameters.
- Multiple parameters are separated by commas.
- Multiple commands are separated by semicolons (compound command).

```
VOLTage:START:LEVel 50PCT;STATE ON
```

In the second command, VOLTage:START: is omitted. This is possible because that path is set to VOLTage:START by the first command (VOLTage:START:LEVel).

This compound command is equivalent to entering the following commands.

```
VOLTage:START:LEVel 50PCT
```

```
VOLTage:START:STATE ON
```

If you specify a node that is not defined in the current path, an error will occur.

By using colons and semicolons, you can concatenate commands of different sub-systems.

```
SOURCE:FUNCTION ACW;;SENSe:CURRENT:SECondary PHOLd
```

There are two root nodes in this compound command: SOURCE and SENSe.

When the second command or later begins with a colon, the path that was specified by the previous command is cleared.

- The maximum length of a command that you can transmit on a single line is 512 bytes.

■ Special symbols

The special symbols that are used in this manual for the SCPI command syntax are explained below.

- Characters and numbers enclosed by { and } and delimited by “|” indicate that one of the delimited items is to be selected.
Do not include the { and } symbols in the actual program.
- <> denotes program data.
Do not include the < and > symbols in the actual program.
- [] denotes optional data.
When optional data is not sent with the program, the default value is applied.
Do not include the [and] symbols in the actual program.

■ Query

You can query the device settings and status.

To make a query, append a question mark to the end of the program header section.

If the query has parameters, insert a space after the question mark, and then write the parameters.

```
VOLTage? MIN
```

Response

This is the response to a query. It is a message always sent from the device to the PC. It conveys device status or measured value to the PC.

—Note—

If you want to send two queries on separate lines, send the second query after you have received the response to the first one.

■ Program terminator

All commands must be terminated with a valid terminator.

The terminator for reception and transmission is either LF (line feed, ASCII 0x0A) or EOI (end of identify, USB only).

When you terminate a command string, the path is reset to the root level.

—Note—

CR (ASCII 0x0D) is not a terminator.

■ Common Commands

There are commands that are common to the IEEE488.2 and SCPI standards for functions such as resetting devices and performing self-diagnoses. These common commands start with an asterisk (“*”). These commands may have one or multiple parameters.

Parameters

The SCPI parameter format is derived from the program parameter format that is defined in IEEE 488.2.

The program data expression format that the this product uses is shown below.

■ Non-numeric parameters

String data (String)

String data is used when a series of ASCII characters (20H to 7EH) are requested. Enclose strings in single (' ') or double quotation (" ") marks. The opening and closing quotation marks must match (you cannot mix single and double quotation marks).

```
PROGram:CREate "/BASIC/My test program"
```

If you want to include a quotation mark as part of the string, enter consecutive quotation marks (with no characters between them).

Character data (Character)

Character data is used when only a limited number of values are available for a program setting. Responses are returned in short form.

```
TRIGger:TEST:SOURce {IMMediate|BUS|EXTernal|ONCE}
```

Boolean data (Boolean)

Boolean data is used to express a condition of 1 or 0, or ON or OFF. Responses are returned as 1 or 0.

```
SYSTem:BEEPer {ON|OFF|1|0}
```

Block data (block)

Arbitrary block data that starts with #.

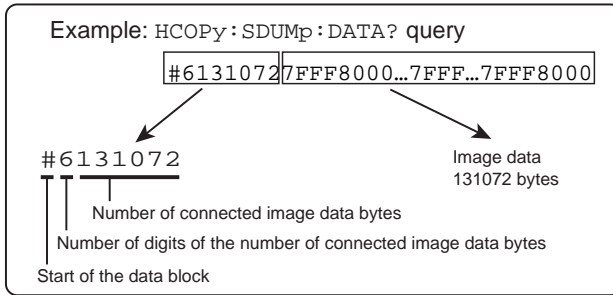

■ Numeric parameters

NR1

Represents an integer value.

Details are given in the “IEEE 488.2 Standard Digital Interface for Programmable Instrumentation.”

If a 0 is returned in the response data, it is returned as +0.

NR2

Represents a real number in floating-point format.

Details are given in the “IEEE 488.2 Standard Digital Interface for Programmable Instrumentation.”

NR3

Represents a real number in scientific notation.

Details are given in the “IEEE 488.2 Standard Digital Interface for Programmable Instrumentation.”

If 380 is returned in the response data, it is returned as +3.80000E+02. Five decimal places are used.

If the value is invalid or the measurement has failed, it is returned as +9.91000E+37.

In the event of +OVER, it is returned as +9.90000E+37.

In the event of -OVER, it is returned as -9.90000E+37.

NRf

NRf is a generic term that includes NR1, NR2, and NR3.

If a value outside the setting range is specified, an error (-222, "Data out of range") will occur.

Numeric

Numeric parameter for values such as the decimal point, optional prefixes, and measurement units.

Numbers are expressed the same as NRf.

MINimum, MAXimum, and the like are available as substitutes for declaring certain values.

You can also use units such as V, A, and W in numeric parameters.

If a value outside the setting range is specified, an error (-222, "Data out of range") will occur.

■ Special form numeric parameters

The special form numeric parameters MINimum and MAXimum can be used as substitutes for the actual maximum and minimum values when the parameter is numeric.

In the following example, the test voltage of the ACW test is set to the minimum value.

```
ACW:VOLTage MINimum
```

You can query the minimum and maximum values for most parameters.

```
ACW:VOLTage? MAX
```

```
ACW:VOLTage? MIN
```

■ Measurement units

The default measurement units are listed below. Commands are accepted even if measurement units are not specified.

- V (voltage)
- A (current)
- HR (hours)
- MIN (minutes)
- S (seconds)
- C (electric charge)
- HZ (frequency)
- OHM (resistance)

The following optional prefixes are supported. If you use optional prefixes, specify the measurement unit.

- G (giga)
- MA (mega)
- M (milli, mega)
- K (kilo)
- P (pico)
- U (micro)

—Note—

- The unit symbols in the International System of Units contain lowercase characters. The IEEE standard uses uppercase characters. SCPI commands are not case sensitive.
- Commands are accepted whether or not measurement units are specified.
- The optional prefix “M” is interpreted as “mega” when the measurement unit is “HZ” or “OHM.” For other measurement units, it is interpreted as “milli.”
- To enter “ μ ” in the data, use “U” instead.

IEEE 488.2 common commands

*CLS

Clears all event registers including the status byte, event status, and error queue.
Clears the operation complete standby that was created by the *OPC or *OPC? command.

Command

*CLS

*ESE

Sets the event status enable register that is counted by the event summary bit (ESB) of the status byte.

Command

*ESE <NRf>

*ESE?

Parameter

Value: 0 to 255

Example: When *ESE 16 is transmitted, bit 4 of the event status enable register is set. Each time the execution error bit (bit 4) of the event status register is set, the summary bit (ESB) of the status byte is set.

Response: NR1

*ESR

Queries the event status register.

The event status register is cleared when read.

Command

*ESR?

Response: NR1

*IDN

Queries the model name and firmware version of the product.

Command

*IDN?

Response

Returns the following information in response to *IDN?.

Response example: For a TOS9301 with serial number AB123400 and version 1.17
IFC1.07.0133, FPGA1.04.0007, IOC1.07.0105

KIKUSUI,TOS9301,AB123400,1.17 IFC1.07.0133 FPGA1.04.0007 IOC1.07.0105
is returned.

***OPC**

Sets the OPC bit (bit 0) of the event status register when all the commands that are in standby have been processed.

See IEEE 488.2-1992 section 12.5.3.

Command

*OPC

*OPC?

Response

Returns "1" when the processing of all commands in standby is complete.

***OPT**

Queries the options that are installed in the product.

Command

*OPT?

Response

Returns the installed options in comma-separated string format. Returns "0" if no options are installed.

*PSC

Sets whether the event status enable register and service request enable register are cleared when the POWER switch is turned on.

Command

```
*PSC <boolean>
```

```
*PSC?
```

Parameter <boolean>

Value: ON(1) When the POWER switch is turned on, the *ESE and *SRE settings are cleared.

OFF(0) When the POWER switch is turned on, the *ESE and *SRE settings are not cleared.

Example To enable the power-on SRQ function:

```
*PSC 0;*SRE 32;*ESE 128
```

Response: NR1

*RCL

Recalls memory content.

Clears alarms.

Aborts the trigger subsystem operation.

Command

```
*RCL <NRf>
```

Parameter

Value: 0 to 50 memory number

Example

```
*RCL 1
```

***RST**

Resets the panel settings (see the table below).

Clears alarms (if they cannot be cleared, alarms continue).

Aborts the trigger subsystem operation.

Clears the OPC bit (bit 0) of the status event register.

Command	*RST	Command	*RST
ACW:VOLT	0V	CALC:TC:SCAL:CONV:VOLT	80V
ACW:VOLT:END:STAT	OFF	CALC:TC:SCAL:OFFS	0A
ACW:VOLT:FREQ	50HZ	DATA:BSIZ	1024
ACW:VOLT:PROT	5500V	DATA:FORM	'1
ACW:VOLT:STAR	50PCT	DATA:REM	'2
ACW:VOLT:STAR:STAT	OFF	DCW:VOLT	0V
ACW:VOLT:SWE:FALL:TIM	0.1S	DCW:VOLT:DISC:INT:STAT	ON
ACW:VOLT:SWE:FALL:TIM:STAT	OFF	DCW:VOLT:DISC:TIM	0S
ACW:VOLT:SWE:TIM	0.1S	DCW:VOLT:END:STAT	OFF
ACW:VOLT:TIM	0.2S	DCW:VOLT:PROT	7500V
ACW:VOLT:TIM:STAT	ON	DCW:VOLT:STAR	50PCT
CALC:ACW:SCAL	OFF	DCW:VOLT:STAR:STAT	OFF
CALC:ACW:SCAL:OFFS	0A	DCW:VOLT:SWE:FALL:TIM	0.1S
CALC:ACW:SCAL:OFFS:IMAG	0A	DCW:VOLT:SWE:FALL:TIM:STAT	OFF
CALC:DCW:SCAL	OFF	DCW:VOLT:SWE:TIM	0.1S
CALC:DCW:SCAL:OFFS	0A	DCW:VOLT:TIM	0.2S
CALC:EC:DC:SCAL	OFF	DCW:VOLT:TIM:STAT	ON
CALC:EC:DC:SCAL:OFFS	0OHM	DISP:ACW:CURR:PHOL	OFF
CALC:EC:SCAL	OFF	DISP:DCW:CURR:PHOL	OFF
CALC:EC:SCAL:OFFS	0OHM	DISP:EC:CURR:PHOL	OFF
CALC:IR:SCAL	OFF	DISP:EC:DC:CURR:PHOL	OFF
CALC:IR:SCAL:OFFS	100MOHM	DISP:IR:RES:PHOL	OFF
CALC:MET:SCAL	OFF	DISP:PAT:CURR:PHOL	OFF
CALC:MET:SCAL:OFFS	0A	DISP:PCC:CURR:PHOL	OFF
CALC:PAT:SCAL	OFF	DISP:PD:COUL:PHOL	OFF
CALC:PAT:SCAL:CONV	OFF	DISP:TC:CURR:PHOL	OFF
CALC:PAT:SCAL:CONV:VOLT	80V	EC:AC:CURR	3A
CALC:PAT:SCAL:OFFS	0A	EC:AC:CURR:PROT	42A
CALC:PCC:SCAL	OFF	EC:AC:CURR:SWE:FALL:TIM	0.1S
CALC:PCC:SCAL:CONV	OFF	EC:AC:CURR:SWE:FALL:TIM:STAT	OFF
CALC:PCC:SCAL:CONV:VOLT	80V	EC:AC:CURR:SWE:TIM	0.1S
CALC:PCC:SCAL:OFFS	0A	EC:AC:CURR:TIM	0.2S
CALC:PD:PREC	EVER	EC:AC:CURR:TIM:STAT	ON
CALC:PD:VOLT:EXT:THR	1000PC	EC:CURR:FREQ	50HZ
CALC:PD:VOLT:INC:THR	1000PC	EC:DC:CURR	3A
CALC:SCAL:OFFS:AUTO	OFF	EC:DC:CURR:PROT	42A
CALC:TC:SCAL	OFF	EC:DC:CURR:SWE:FALL:TIM	0.1S
CALC:TC:SCAL:CONV	OFF	EC:DC:CURR:SWE:FALL:TIM:STAT	OFF

Command	*RST
EC:DC:CURR:SWE:TIM	0.1S
EC:DC:CURR:TIM	0.2S
EC:DC:CURR:TIM:STAT	ON
FUNC	ACW
GRAP:PD:FORM	QT
GRAP:PD:MARK	ON
GRAP:PD:SCAL	FIX
IR:VOLT	0V
IR:VOLT:DISC:INT:STAT	ON
IR:VOLT:DISC:TIM	0S
IR:VOLT:PROT	1020V
IR:VOLT:RANG	1000V
IR:VOLT:STAR	50PCT
IR:VOLT:STAR:STAT	OFF
IR:VOLT:SWE:TIM	0.1S
IR:VOLT:TIM	0.2S
IR:VOLT:TIM:STAT	ON
OUTP	OFF
OUTP:110P	OFF
OUTP:110P:POL	NORM
PAT:110P:OUTP	OFF
PAT:110P:POL	NORM
PAT:POL	NORM
PCC:POL	NORM
PD:VOLT	0V
PD:VOLT:FREQ	50HZ
PD:VOLT:PATT	RAMP
PD:VOLT:PROT	5500V
PD:VOLT:SEC	0V
PD:VOLT:SEC:SWE:FALL:TIM	1S
PD:VOLT:SEC:TIM	1S
PD:VOLT:SEC:TIM:STAT	ON
PD:VOLT:STEP	0V
PD:VOLT:STEP:TIM	1S
PD:VOLT:SWE:FALL:TIM	1S
PD:VOLT:SWE:FALL:TIM:STAT	ON
PD:VOLT:SWE:TIM	1S
PD:VOLT:TIM	1S
PD:VOLT:TIM:STAT	ON
PROG	""
RES:TZON	UTC
ROUT:ACW:TERM	OPEN
ROUT:ACW:TERM:CCH	OFF
ROUT:DCW:TERM	OPEN
ROUT:DCW:TERM:CCH	OFF
ROUT:IR:TERM	OPEN
ROUT:IR:TERM:CCH	OFF

Command	*RST
SAMP:COUN	INF
SAMP:TEST:ENAB	ON
SAMP:TIM	0
SENS:ACW:CURR:FILT:HPAS	SLOW
SENS:ACW:CURR:FILT:LPAS	SLOW
SENS:ACW:CURR:FILT:TYPE	LOW
SENS:ACW:CURR:MODE	RMS
SENS:ACW:JUDG	0.01MA
SENS:ACW:JUDG:LOW	0A
SENS:ACW:JUDG:LOW:STAT	OFF
SENS:ACW:TERM:GRO	LOW
SENS:ACW:VOLT:MODE	RMS
SENS:DCW:CURR:FILT:HPAS	SLOW
SENS:DCW:CURR:FILT:LPAS	SLOW
SENS:DCW:CURR:FILT:TYPE	LOW
SENS:DCW:JUDG	0.01MA
SENS:DCW:JUDG:DEL	0.1S
SENS:DCW:JUDG:DEL:AUTO	OFF
SENS:DCW:JUDG:LOW	0A
SENS:DCW:JUDG:LOW:STAT	OFF
SENS:DCW:TERM:GRO	LOW
SENS:DCW:VOLT:MODE	AVER
SENS:EC:DC:JUDG	0.0001OHM
SENS:EC:DC:JUDG:LOW	0OHM
SENS:EC:DC:JUDG:LOW:STAT	OFF
SENS:EC:DC:JUDG:STAT	ON
SENS:EC:DC:JUDG:TYPE	RES
SENS:EC:DC:JUDG:VOLT	2.5V
SENS:EC:DC:JUDG:VOLT:LOW	0V
SENS:EC:DC:JUDG:VOLT:LOW:STAT	OFF
SENS:EC:DC:JUDG:VOLT:STAT	ON
SENS:EC:DC:TERM:CCH	OFF
SENS:EC:DC:TERM:WIRE	4
SENS:EC:JUDG	0.0001OHM
SENS:EC:JUDG:LOW	0OHM
SENS:EC:JUDG:LOW:STAT	OFF
SENS:EC:JUDG:STAT	ON
SENS:EC:JUDG:TYPE	RES
SENS:EC:JUDG:VOLT	2.5V
SENS:EC:JUDG:VOLT:LOW	0V
SENS:EC:JUDG:VOLT:LOW:STAT	OFF
SENS:EC:JUDG:VOLT:STAT	ON
SENS:EC:TERM:CCH	OFF
SENS:EC:TERM:WIRE	4
SENS:IR:CURR:FILT:LPAS:STAT	OFF
SENS:IR:JUDG	100MOHM
SENS:IR:JUDG:CURR	0.0001MA

Command	*RST	Command	*RST
SENS:IR:JUDG:CURR:LOW	0A	SENS:PCC:JUDG:LOW	0.01MA
SENS:IR:JUDG:CURR:LOW:STAT	OFF	SENS:PCC:JUDG:LOW:STAT	OFF
SENS:IR:JUDG:CURR:STAT	ON	SENS:PCC:JUDG:STAT	ON
SENS:IR:JUDG:DEL	0.1S	SENS:PCC:NETW	PCC-1
SENS:IR:JUDG:DEL:AUTO	OFF	SENS:PCC:RANG:AUTO	ON
SENS:IR:JUDG:LOW	1MOHM	SENS:PCC:TIM	1S
SENS:IR:JUDG:LOW:STAT	ON	SENS:PCC:TIM:STAT	ON
SENS:IR:JUDG:STAT	OFF	SENS:PD:FILT:BPAS	160KHZ
SENS:IR:JUDG:TYPE	RES	SENS:PD:FILT:LPAS:STAT	ON
SENS:IR:TERM:GRO	LOW	SENS:PD:JUDG	1000PC
SENS:MET:CURR:MODE	ACDC	SENS:PD:JUDG:PCO	1
SENS:MET:NETW	A	SENS:PD:JUDG:PCO:STAT	ON
SENS:MET:RANG	42V	SENS:PD:JUDG:STAT	ON
SENS:MET:RANG:AUTO	ON	SENS:PD:PCO:THR	25OCT
SENS:MET:SELV	30V	SENS:PD:RANG	10000PC
SENS:MET:SELV:STAT	ON	SENS:PD:VOLT:MODE	RMS
SENS:MET:TERM	NETW	SENS:TC:BAND	NORM
SENS:PAT:BAND	NORM	SENS:TC:COND	NORM
SENS:PAT:COND	NORM	SENS:TC:COND:FAUL	NEUT
SENS:PAT:COND:FAUL	NEUT	SENS:TC:CURR:MODE	ACDC
SENS:PAT:CURR:MODE	ACDC	SENS:TC:JUDG	100UA
SENS:PAT:JUDG	100UA	SENS:TC:JUDG:DEL	1S
SENS:PAT:JUDG:DEL	1S	SENS:TC:JUDG:DEL:STAT	OFF
SENS:PAT:JUDG:DEL:STAT	OFF	SENS:TC:JUDG:LOW	0.01MA
SENS:PAT:JUDG:LOW	0.01MA	SENS:TC:JUDG:LOW:STAT	OFF
SENS:PAT:JUDG:LOW:STAT	OFF	SENS:TC:JUDG:STAT	ON
SENS:PAT:JUDG:STAT	ON	SENS:TC:NETW	A
SENS:PAT:NETW	I	SENS:TC:NETW:PROB	PEAR
SENS:PAT:NETW:PROB	PEAR	SENS:TC:RANG:AUTO	ON
SENS:PAT:RANG:AUTO	ON	SENS:TC:TIM	1S
SENS:PAT:TIM	1S	SENS:TC:TIM:STAT	ON
SENS:PAT:TIM:STAT	ON	TC:110P:OUTP	OFF
SENS:PCC:BAND	NORM	TC:110P:POL	NORM
SENS:PCC:COND	NORM	TC:POL	NORM
SENS:PCC:CURR:MODE	ACDC	TRIG:ACQ:COUN	1
SENS:PCC:JUDG	100UA	TRIG:ACQ:DEL	0
SENS:PCC:JUDG:DEL	1S	TRIG:ACQ:SOUR	TST
SENS:PCC:JUDG:DEL:STAT	OFF	TRIG:TEST:SOUR	IMM

*1. CURR,CRE,CIM,VOLT,RES,ETIM

*2. Number of data points that can be queried

Command

*RST

*SAV

Saves the panel settings to the setup memory.

Command

*SAV <NRf>

Parameter

Value: 0 to 50 memory number

Example

*SAV 1

*SRE

Sets the service request enable register.

The service request enable register can be used to select which summary messages in the status byte register will perform service requests.

To clear the service request enable register, send *SRE 0. If the register is cleared, service requests cannot be generated using status information.

Command

*SRE <NRf>

*SRE?

Parameter

Value: 0 to 255

Example: Sending *SRE 8 sets bit 3 of the service request enable register. Each time the summary bit (bit 3) of the QUESTIONable status register in the status byte is set, a service request message is generated.

Response: NR1

***STB**

Queries the contents of the status byte register and the MSS (master summary status) message.

The response is the same as serial polling only with the exception that the MSS message appears in place of the RQS message in bit 6.

Command

*STB?

Response: NR1

***TRG**

Trigger command.

Executes trigger on the TEST trigger group.

This is a substitute command for IEEE 488.1 get (Group Execute Trigger).

If the device is in a state in which it does not accept triggers, an SCPI error (-211, "Trigger ignored") occurs.

See IEEE 488.2-1992 section 10.37.

Command

*TRG

*TST

Executes a self-test.

You can check which error occurred with SYST:ERR? command. See IEEE 488.2-1992 section 10.38.

Command

*TST?

Response

If there is no problem, returns 0 in response to *TST?. Returns an error code if there is a problem.

*WAI

Prevents the device from executing subsequent commands until all operations that are in standby have completed.

Command

*WAI

ABORt Command

This product has two trigger subsystems (ACQuire, TEST).

ACQuire is a measurement trigger subsystem.

TEST is a test trigger subsystem.

ABOR

Aborts measurements, tests, and other operations in all trigger subsystems (ACQuire, TEST).

The product's trigger state immediately after it turns on is the same as its trigger state after it receives an ABOR command.

If you send an ABOR command without initiating, the measured data is not discarded.

You cannot specify a trigger subsystem with the ABOR command. It is always interpreted as ALL.

Command

```
ABORt [ :ALL ]
```

ABOR:ACQ

Aborts measurement operations.

If you send an ABOR command without initiating, the measured data is not discarded.

Command

ABORt:ACQuire

ABOR:TEST

Stops the ongoing test. Clears the protection/ fail mode.

If you send an ABOR command without initiating, the test data is not discarded.

Command

ABORt:TEST

CALCulate Command

CALC:SCAL:OFFS:AUTO

Sets whether to automatically set the offset before testing.

If the setting is set to ON (automatically), the this setting turns OFF when a test is performed.

Valid test mode: ACW、DCW、IR、ECAC、ECDC、TC、PCC、PAT

Command

```
CALCulate:SCALE:OFFSet:AUTO[:MEASure] <boolean>
```

```
CALCulate:SCALE:OFFSet:AUTO[:MEASure]?
```

Parameter

Value:	ON(1)	Offset is set automatically.
	OFF(0)	Offset is not set automatically. (default)

Settings is reset to default when the *RST command is sent.

Response: NR1

Example

```
CALC:SCAL:OFFS:AUTO ON
```

CALC:ACW Command

The ACW in the second node can be omitted, but to distinguish it from the DC with-standing voltage test, we recommend that you do not.

The offset current is converted into resistance and sent to the TOS9300 series. The TOS9300 series calculates the current from the resistance and voltage and displays the result on the panel. Since the resistance resolution is 100Ω , an error may occur between the offset current setting and panel reading.

CALC:ACW:SCAL

Sets whether to offset the current running through the stray capacitance in AC with-standing voltage tests.

Set the real part of the current with CALC:ACW:SCAL:OFFS.

Set the imaginary part of the current with CALC:ACW:SCAL:OFFS:IMAG.

Command

```
CALCulate[:ACW]:SCALe[:STATe] <boolean>
```

```
CALCulate[:ACW]:SCALe[:STATe]?
```

Parameter

Value:	ON(1)	Offset is applied.
	OFF(0)	Offset is not applied. (default)

Settings is reset to default when the *RST command is sent.

Response: NR1

Example

```
CALC:ACW:SCAL ON
```

CALC:ACW:SCAL:OFFS

Sets the real part of the offset current in AC withstanding voltage tests.

This is valid when CALC:ACW:SCAL ON.

Command

```
CALCulate[:ACW][:CURRENT]:SCALE:OFFSet[:REAL] <numeric>
```

```
CALCulate[:ACW][:CURRENT]:SCALE:OFFSet[:REAL]?
```

Unit: A

Settings is reset to default when the *RST command is sent. (0 A)

Response: NR3

Example

```
CALC:ACW:SCAL:OFFS 123MA
```

CALC:ACW:SCAL:OFFS:IMAG

Sets the imaginary part of the offset current in AC withstanding voltage tests.

This is valid when CALC:ACW:SCAL ON.

Command

```
CALCulate[:ACW][:CURRENT]:SCALE:OFFSet:IMAGinary <numeric>
```

```
CALCulate[:ACW][:CURRENT]:SCALE:OFFSet:IMAGinary?
```

Unit: A

Settings is reset to default when the *RST command is sent. (0 A)

Response: NR3

Example

```
CALC:ACW:SCAL:OFFS:IMAG 123UA
```

CALC:DCW Command

The offset current is converted into resistance and sent to the TOS9300 series. The TOS9300 series calculates the current from the resistance and voltage and displays the result on the panel. Since the resistance resolution is 100 Ω , an error may occur between the offset current setting and panel reading.

CALC:DCW:SCAL

Sets whether to offset the current running through the stray capacitance in DC withstanding voltage tests.

Set the current with CALC:DCW:SCAL:OFFS.

Command

```
CALCulate:DCW:SCALE[:STATe] <boolean>
```

```
CALCulate:DCW:SCALE[:STATe]?
```

Parameter

Value:	ON(1)	Offset is applied.
	OFF(0)	Offset is not applied. (default)

Settings is reset to default when the *RST command is sent.

Response: NR1

Example

```
CALC:DCW:SCAL 1
```

CALC:DCW:SCAL:OFFS

Sets the offset current for DC withstanding voltage tests.

This is valid when CALC:DCW:SCAL ON.

Command

```
CALCulate:DCW[:CURRENT]:SCALE:OFFSet[:REAL] <numeric>
```

```
CALCulate:DCW[:CURRENT]:SCALE:OFFSet[:REAL]?
```

Unit: A

Settings is reset to default when the *RST command is sent. (0 A)

Response: NR3

Example

```
CALC:DCW:SCAL:OFFS 123MA
```

CALC:EC Command

CALC:EC:SCAL

Sets whether to offset the voltage drop caused by the contact resistance in earth continuity tests (AC).

Set the voltage with CALC:EC:SCAL:OFFS.

Command

```
CALCulate:EC[:AC]:SCALE[:STATE] <boolean>
```

```
CALCulate:EC[:AC]:SCALE[:STATE]?
```

Parameter

Value:	ON(1)	Offset is applied.
	OFF(0)	Offset is not applied. (default)

Settings is reset to default when the *RST command is sent.

Response: NR1

Example

```
CALC:EC:SCAL ON
```

CALC:EC:SCAL:OFFS

Sets the offset resistance for earth continuity tests (AC).

This is valid when CALC:EC:SCAL ON.

Command

```
CALCulate:EC[:AC][:RESistance]:SCALE:OFFSet[:REAL] <numeric>
```

```
CALCulate:EC[:AC][:RESistance]:SCALE:OFFSet[:REAL]?
```

Unit: OHM

Settings is reset to default when the *RST command is sent. (0 OHM)

Response: NR3

Example

```
CALC:EC:SCAL:OFFS 50HM
```

CALC:EC:DC:SCAL

Sets whether to offset the voltage drop caused by the contact resistance in earth continuity tests (DC).

Set the voltage with CALC:EC:DC:SCAL:OFFS.

Command

```
CALCulate:EC:DC:SCALe[:STATe] <boolean>
```

```
CALCulate:EC:DC:SCALe[:STATe]?
```

Parameter

Value:	ON(1)	Offset is applied.
	OFF(0)	Offset is not applied. (default)

Settings is reset to default when the *RST command is sent.

Response: NR1

Example

```
CALC:EC:DC:SCAL ON
```

CALC:EC:DC:SCAL:OFFS

Sets the offset resistance for earth continuity tests (DC).

This is valid when CALC:EC:DC:SCAL ON.

Command

```
CALCulate:EC:DC[:RESistance]:SCALe:OFFSet[:REAL] <numeric>
```

```
CALCulate:EC:DC[:RESistance]:SCALe:OFFSet[:REAL]?
```

Unit: OHM

Settings is reset to default when the *RST command is sent. (0 OHM)

Response: NR3

Example

```
CALC:EC:DC:SCAL:OFFS 50HM
```

CALC:IR Command

CALC:IR:SCAL

Sets whether to offset the resistance applied to the stray capacitance in insulation resistance tests.

Set the resistance with CALC:IR:SCAL:OFFS.

Command

```
CALCulate:IR:SCALe[:STATe] <boolean>
```

```
CALCulate:IR:SCALe[:STATe]?
```

Parameter

Value:	ON(1)	Offset is applied.
	OFF(0)	Offset is not applied. (default)

Settings is reset to default when the *RST command is sent.

Response: NR1

Example

```
CALC:IR:SCAL 1
```

CALC:IR:SCAL:OFFS

Sets the offset resistance for insulation resistance tests.

This is valid when CALC:IR:SCAL ON.

Command

```
CALCulate:IR[:RESistance]:SCALe:OFFSet[:REAL] <numeric>
```

```
CALCulate:IR[:RESistance]:SCALe:OFFSet[:REAL]?
```

Unit: OHM

Settings is reset to default when the *RST command is sent. (100 MOHM)

Response: NR3

Example

```
CALC:IR:SCAL:OFFS 10KOHM
```

CALC:MET Command

CALC:MET:SCAL

Sets whether to offset the current in meter mode.

Set the current with CALC:MET:SCAL:OFFS.

Command

```
CALCulate:METer:SCALE[:STATE] <boolean>
```

```
CALCulate:METer:SCALE[:STATE]?
```

Parameter

Value:	ON(1)	Offset is applied.
	OFF(0)	Offset is not applied. (default)

Settings is reset to default when the *RST command is sent.

Response: NR1

Example

```
CALC:MET:SCAL 1
```

CALC:MET:SCAL:OFFS

Sets the offset current for meter mode.

This is valid when CALC:MET:SCAL ON.

Command

```
CALCulate:METer[:CURRENT]:SCALE:OFFSet[:REAL] <numeric>
```

```
CALCulate:METer[:CURRENT]:SCALE:OFFSet[:REAL]?
```

Unit: A

Settings is reset to default when the *RST command is sent. (0 A)

Response: NR3

Example

```
CALC:MET:SCAL:OFFS 123MA
```

CALC:PAT Command

CALC:PAT:SCAL

Sets whether to offset the current in patient leakage current tests.

Set the current with CALC:PAT:SCAL:OFFS.

Command

```
CALCulate:PATient:SCALe[:STATe] <boolean>
```

```
CALCulate:PATient:SCALe[:STATe]?
```

Parameter

Value:	ON(1)	Offset is applied.
	OFF(0)	Offset is not applied. (default)

Settings is reset to default when the *RST command is sent.

Response: NR1

Example

```
CALC:PAT:SCAL 1
```

CALC:PAT:SCAL:OFFS

Sets the offset current for patient leakage current tests.

This is valid when CALC:PAT:SCAL ON.

Command

```
CALCulate:PATient[:CURRent]:SCALe:OFFSet[:REAL] <numeric>
```

```
CALCulate:PATient[:CURRent]:SCALe:OFFSet[:REAL]?
```

Unit: A

Settings is reset to default when the *RST command is sent. (0 A)

Response: NR3

Example

```
CALC:PAT:SCAL:OFFS 123MA
```

CALC:PAT:SCAL:CONV

Sets whether to convert the current with the specified voltage in patient leakage current tests.

Set the voltage with CALC:PAT:SCAL:CONV:VOLT.

Command

```
CALCulate:PATient[:CURRent]:SCALE:CONVert[:STATE] <boolean>
```

```
CALCulate:PATient[:CURRent]:SCALE:CONVert[:STATE]?
```

Parameter

Value:	ON(1)	Conversion is applied.
	OFF(0)	Conversion is not applied. (default)

Settings is reset to default when the *RST command is sent.

Response: NR1

Example

```
CALC:PAT:SCAL:CONV 1
```

CALC:PAT:SCAL:CONV:VOLT

Sets the conversion voltage for patient leakage current tests.

This is valid when CALC:PAT:SCAL:CONV ON.

Command

```
CALCulate:PATient[:CURRent]:SCALE:CONVert:VOLTage <numeric>
```

```
CALCulate:PATient[:CURRent]:SCALE:CONVert:VOLTage?
```

Unit: V

Settings is reset to default when the *RST command is sent. (80 V)

Response: NR3

Example

```
CALC:PAT:SCAL:CONV:VOLT 220V
```

CALC:PCC Command

CALC:PCC:SCAL

Sets whether to offset the current in protective conductor current tests.

Set the current with CALC:PCC:SCAL:OFFS.

Command

```
CALCulate:PCCurrent:SCALE[:STATE] <boolean>
```

```
CALCulate:PCCurrent:SCALE[:STATE]?
```

Parameter

Value:	ON(1)	Offset is applied.
	OFF(0)	Offset is not applied. (default)

Settings is reset to default when the *RST command is sent.

Response: NR1

Example

```
CALC:PCC:SCAL 1
```

CALC:PCC:SCAL:OFFS

Sets the offset current for protective conductor current tests.

This is valid when CALC:PCC:SCAL ON.

Command

```
CALCulate:PCCurrent[:CURRENT]:SCALE:OFFSet[:REAL] <numeric>
```

```
CALCulate:PCCurrent[:CURRENT]:SCALE:OFFSet[:REAL]?
```

Unit: A

Settings is reset to default when the *RST command is sent. (0 A)

Response: NR3

Example

```
CALC:PCC:SCAL:OFFS 123MA
```

CALC:PCC:SCAL:CONV

Sets whether to convert the current with the specified voltage in protective conductor current tests.

Set the voltage with CALC:PCC:SCAL:CONV:VOLT.

Command

```
CALCulate:PCCurrent[:CURRent]:SCALE:CONVert[:STATe] <boolean>
```

```
CALCulate:PCCurrent[:CURRent]:SCALE:CONVert[:STATe]?
```

Parameter

Value:	ON(1)	Conversion is applied.
	OFF(0)	Conversion is not applied. (default)

Settings is reset to default when the *RST command is sent.

Response: NR1

Example

```
CALC:PCC:SCAL:CONV 1
```

CALC:PCC:SCAL:CONV:VOLT

Sets the conversion voltage for protective conductor current tests.

This is valid when CALC:PCC:SCAL:CONV ON.

Command

```
CALCulate:PCCurrent[:CURRent]:SCALE:CONVert:VOLTage <numeric>
```

```
CALCulate:PCCurrent[:CURRent]:SCALE:CONVert:VOLTage?
```

Unit: V

Settings is reset to default when the *RST command is sent. (80 V)

Response: NR3

Example

```
CALC:PCC:SCAL:CONV:VOLT 220V
```

CALC:PD Command

CALC:PD:PREC

Sets the calibration of a discharge electric charge in partial discharge tests.

Command

```
CALCulate:PD:PRECalibration <character>
```

```
CALCulate:PD:PRECalibration?
```

Parameter

Value:	EVERy	Auto calibration before a test (default)
	ONCE	Manual calibration

Settings is reset to default when the *RST command is sent.

Response: character

Example

```
CALC:PD:PREC ONCE
```

CALC:PD:PREC:EXEC

Executes calibration in partial discharge tests.

Command

```
CALCulate:PD:PRECalibration:EXECute
```

CALC:PD:PREC:STAT

Returns the state of calibration in partial discharge tests.

Command

```
CALCulate:PD:PRECalibration:STATe?
```

Response: character

parameter:	NOTC	Not calibrated
	EXEC	Calibration is being executed.
	SUCC	Calibration is successful.
	UNS	Calibration is not successful.

CALC:PD:VOLT:EXT:THR

Sets the electric charge to judge the discharge extinction voltage in partial discharge tests.

Command

```
CALCulate:PD:VOLTage:EXTinction:THReshold[:COULomb][:REAL] <numeric>
```

```
CALCulate:PD:VOLTage:EXTinction:THReshold[:COULomb][:REAL]?
```

Unit: C

Settings is reset to default when the *RST command is sent. (1000 PC)

Response: NR3

Example

```
CALC:PD:VOLT:EXT:THR 123PC
```

CALC:PD:VOLT:INC:THR

Sets the electric charge to judge the discharge inception voltage in partial discharge tests.

Command

```
CALCulate:PD:VOLTage:INCeption:THReshold[:COULomb][:REAL] <numeric>
```

```
CALCulate:PD:VOLTage:INCeption:THReshold[:COULomb][:REAL]?
```

Unit: C

Settings is reset to default when the *RST command is sent. (1000 PC)

Response: NR3

Example

```
CALC:PD:VOLT:INC:THR 123PC
```

CALC:TC Command

CALC:TC:SCAL

Sets whether to offset the current in touch current tests.

Set the current with CALC:TC:SCAL:OFFS.

Command

```
CALCulate:TC:SCALE[:STATe] <boolean>
```

```
CALCulate:TC:SCALE[:STATe]?
```

Parameter

Value:	ON(1)	Offset is applied.
	OFF(0)	Offset is not applied. (default)

Settings is reset to default when the *RST command is sent.

Response: NR1

Example

```
CALC:TC:SCAL 1
```

CALC:TC:SCAL:OFFS

Sets the offset current for touch current tests.

This is valid when CALC:TC:SCAL ON.

Command

```
CALCulate:TC[:CURRent]:SCALE:OFFSet[:REAL] <numeric>
```

```
CALCulate:TC[:CURRent]:SCALE:OFFSet[:REAL]?
```

Unit: A

Settings is reset to default when the *RST command is sent. (0 A)

Response: NR3

Example

```
CALC:TC:SCAL:OFFS 123MA
```

CALC:TC:SCAL:CONV

Sets whether to convert the current with the specified voltage in touch current tests.

Set the voltage with CALC:TC:SCAL:CONV:VOLT.

Command

```
CALCulate:TC[:CURRENT]:SCALE:CONVert[:STATE] <boolean>
```

```
CALCulate:TC[:CURRENT]:SCALE:CONVert[:STATE]?
```

Parameter

Value:	ON(1)	Conversion is applied.
	OFF(0)	Conversion is not applied. (default)

Settings is reset to default when the *RST command is sent.

Response: NR1

Example

```
CALC:TC:SCAL:CONV 1
```

CALC:TC:SCAL:CONV:VOLT

Sets the conversion voltage for touch current tests.

This is valid when CALC:TC:SCAL:CONV ON.

Command

```
CALCulate:TC[:CURRENT]:SCALE:CONVert:VOLTage <numeric>
```

```
CALCulate:TC[:CURRENT]:SCALE:CONVert:VOLTage?
```

Unit: V

Settings is reset to default when the *RST command is sent. (80 V)

Response: NR3

Example

```
CALC:TC:SCAL:CONV:VOLT 220V
```

DATA Command

The measurement conditions to be stored on the data logger depend upon the TRIG:ACQ and SAMP subsystems.

Graphs are drawn using measurement data stored on the data logger.

DATA:BSIZ

Sets the buffer size (maximum number of measurement data recordings) of the data logger.

If the buffer overflows during continuous measurement recording, data is deleted with the oldest entry. When you set the buffer size, recorded data is cleared.

Command

```
DATA:BSIZe <NRf>
```

```
DATA:BSIZe?
```

Parameter

Value: 1024, 2048, 4096, 8192

Settings is reset to default when the *RST command is sent. (1024)

Response: NR1

Example

```
DATA:BSIZ 4096
```

DATA:FORM

Sets the response format to use when measurement data is queried.

The response format is used for DATA:REM? or FETC?/READ?/MEAS?.

The same parameter cannot be specified twice.

Command

```
DATA:FORMat <character>[,<character>[,<character>...]]
```

```
DATA:FORMat?
```

Parameter

Value	Description	Response unit	Response-enabled tests ^{*1}
VOLTage	Voltage	V	All
CURRent	Current	A	ACW/ DCW/ IR/ EC/ LC
ETIMe	Elapsed test time	S	All
CREal	Real current	A	ACW/ DCW/ IR/ EC/ LC
CIMaginary	Imaginary current	A	ACW
RESistance	Resistance	OHM	DCW/ IR/ EC
COULomb	Electric charge	C	PD
PULSe	Electric charge pluse count	--	PD
VARiant	Imaginary Current	A	ACW
	Resistance	OHM	DCW/ IR/ EC
	Electric charge	C	PD

*1. ACW: AC withstanding voltage, DCW: DC withstanding voltage, IR: insulation resistance, EC: earth continuity, LC: Leakage current, PD: Partial discharge

CURR, CRE, CIM, VOLT, RES, and ETIM are default settings.

Settings is reset to default when the *RST command is sent.

Response: character,character,..

Example

```
DATA:FORM CURR,VOLT,ETIM
```

Response example: When voltage and current are set

CURR,VOLT is returned.

DATA:POIN

Queries the number of measurements recorded in the data logger.

Command

DATA:POINT?

Response: NR1

DATA:REM

Queries the measurement data recorded in the data logger.

Data that is queried is cleared.

The number of data points that can be referenced at once varies depending on the number of items specified by DATA:FORM.

Number of items specified by DATA:FORM	Number of data points that can be queried
8	512
7	640
6	768
5	896
4	1152
3	1536
2	2304
1	4608

Command

DATA:REMove? [<NRf>]

Parameter

Value: Number of data points to be queried (The default value is the number of data points that can be queried.)

If a value that cannot be assigned is entered, the device rounds the value to the closest possible value.

Response: NR3,NR3,... From the oldest data

The number of data points that is returned is the number of items specified by DATA:FORM × the number of data points specified by DATA:REM? <NRf>.

EMPT No measurement data exists in the data logger. Measurement is in progress.

IDLE No measurement data exists in the data logger. Measurement is not in progress.

Settings is reset to default when the *RST command is sent.

Example

DATA:REM? 512

Display Command

DISP:ACW:CURR:PHOL

Displays the maximum current measurement from the start of the test in AC with-standing voltage tests.

The ACW in the second node can be omitted, but to distinguish it from the DC with-standing voltage test, we recommend that you do not.

Command

```
DISPlay[:ACW]:CURRent:PHOLd <boolean>
```

```
DISPlay[:ACW]:CURRent:PHOLd?
```

Parameter

Value: ON(1) The maximum current measurement is displayed.
 OFF(0) The maximum current measurement is not displayed. (default)

Settings is reset to default when the *RST command is sent.

Response: NR1

Example

```
DISP:ACW:CURR:PHOL ON
```

DISP:DCW:CURR:PHOL

Displays the maximum current measurement from the start of the test in DC with-standing voltage tests.

Command

```
DISPlay:DCW:CURRent:PHOLd <boolean>
```

```
DISPlay:DCW:CURRent:PHOLd?
```

Parameter

Value: ON(1) The maximum current measurement is displayed.
OFF(0) The maximum current measurement is not displayed. (default)

Settings is reset to default when the *RST command is sent.

Response: NR1

Example

```
DISP:DCW:CURR:PHOL ON
```

DISP:EC:AC:CURR:PHOL

Displays the maximum resistance measurement from the start of the test in earth continuity tests (AC).

Command

```
DISPlay:EC[:AC]:CURRent:PHOLd <boolean>
```

```
DISPlay:EC[:AC]:CURRent:PHOLd?
```

Parameter

Value: ON(1) The maximum resistance measurement is displayed.
OFF(0) The maximum resistance measurement is not displayed. (default)

Settings is reset to default when the *RST command is sent.

Response: NR1

Example

```
DISP:EC:AC:CURR:PHOL ON
```

DISP:EC:DC:CURR:PHOL

Displays the maximum resistance measurement from the start of the test in earth continuity tests (DC).

Command

```
DISPlay:EC:DC:CURRent:PHOLd <boolean>
```

```
DISPlay:EC:DC:CURRent:PHOLd?
```

Parameter

Value: ON(1) The maximum resistance measurement is displayed.
OFF(0) The maximum resistance measurement is not displayed. (default)

Settings is reset to default when the *RST command is sent.

Response: NR1

Example

```
DISP:EC:DC:CURR:PHOL ON
```

DISP:IR:RES:PHOL

Displays the minimum resistance measurement from the start of the test in insulation resistance tests.

Command

```
DISPlay:IR:RESistance:PHOLd <boolean>
```

```
DISPlay:IR:RESistance:PHOLd?
```

Parameter

Value: ON(1) The minimum resistance measurement is displayed.
OFF(0) The minimum resistance measurement is not displayed. (default)

Settings is reset to default when the *RST command is sent.

Response: NR1

Example

```
DISP:IR:RES:PHOL ON
```

DISP:PAT:CURR:PHOL

Displays the maximum current measurement from the start of the test in patient leakage current tests.

Command

```
DISPlay:PATient:CURRent:PHOLd <boolean>
```

```
DISPlay:PATient:CURRent:PHOLd?
```

Parameter

Value: ON(1) The maximum current measurement is displayed.
OFF(0) The maximum current measurement is not displayed. (default)

Settings is reset to default when the *RST command is sent.

Response: NR1

Example

```
DISP:PAT:CURR:PHOL ON
```

DISP:PCC:CURR:PHOL

Displays the maximum current measurement from the start of the test in protective conductor current tests.

Command

```
DISPlay:PCCurrent:CURRent:PHOLd <boolean>
```

```
DISPlay:PCCurrent:CURRent:PHOLd?
```

Parameter

Value: ON(1) The maximum current measurement is displayed.
OFF(0) The maximum current measurement is not displayed. (default)

Settings is reset to default when the *RST command is sent.

Response: NR1

Example

```
DISP:PCC:CURR:PHOL ON
```

DISP:PD:COUL:PHOL

Sets whether to display the maximum value of electric charges that have been measured from the start of a partial discharge test.

Command

```
DISPlay:PD:COULomb:PHOLd <boolean>
```

```
DISPlay:PD:COULomb:PHOLd?
```

Parameter

Value:	ON(1)	The maximum value of electric charges is displayed
	OFF(0)	The maximum value of electric charges is not displayed. (default)

Settings is reset to default when the *RST command is sent.

Response: NR1

Example

```
DISP:PD:COUL:PHOL ON
```

DISP:TC:CURR:PHOL

Displays the maximum current measurement from the start of the test in touch current tests.

Command

```
DISPlay:TC:CURRent:PHOLd <boolean>
```

```
DISPlay:TC:CURRent:PHOLd?
```

Parameter

Value: ON(1) The maximum current measurement is displayed.
OFF(0) The maximum current measurement is not displayed. (default)

Settings is reset to default when the *RST command is sent.

Response: NR1

Example

```
DISP:TC:CURR:PHOL ON
```

GRAPh Command

GRAP:PD:FORM

Sets variables to be represented on the axes of a graph in partial discharge tests.

Command

```
GRAPh:PD:FORMat <character>
```

```
GRAPh:PD:FORMat?
```

Parameter

Value: QT Electric charge is represented on the Y-axis and voltage on the X-axis (default).

QV Electric charge is represented on the Y-axis and time on the X-axis.

Settings is reset to default when the *RST command is sent.

Response: character

Example

```
GRAP:PD:FORM QV
```

GRAP:PD:MARK

Sets whether to display the markers for discharge inception voltage and discharge extinction voltage in partial discharge tests.

Command

```
GRAPh:PD[:INCEption:EXTinction]:MARKer[:STATe] <boolean>
```

```
GRAPh:PD[:INCEption:EXTinction]:MARKer[:STATe]?
```

Parameter

Value:	ON(1)	The markers for discharge inception voltage and discharge extinction voltage is displayed. (default)
	OFF(0)	The markers for discharge inception voltage and discharge extinction voltage is not displayed.

Settings is reset to default when the *RST command is sent.

Response: NR1

Example

```
GRAP:PD:MARK ON
```

GRAP:PD:SCAL

Sets the display method for the graph scale in partial discharge tests.

Command

```
GRAPh:PD:SCALe <character>
```

```
GRAPh:PD:SCALe?
```

Parameter

Value:	AUTO	Automatically adjusts the graph scale according to the measured values.
	FIX	Fixed scale (default)

Settings is reset to default when the *RST command is sent.

Response: character

Example

```
GRAP:PD:SCAL AUTO
```

HCOPY Command

HCOP:SDUM:DATA

Retrieves the screen capture of the present screen.

Command

HCOPY:SDUMp:DATA?

Response

The screen image (PNG) is returned in block (#6<length><data>) format.

INITiate Command

INIT

Invalidates the present measurement data (data logger) and starts a new measurement.

Starts the test trigger function.

Command

```
INITiate[:IMMEDIATE][:ALL]
```

INIT:ACQ

Invalidates the present measured data (data logger) and starts a new measurement.

Command

```
INITiate[:IMMEDIATE]:ACQUIRE
```

INIT:TEST

Starts the test trigger function.

When the trigger source is set to IMM, the auto test is executed immediately. When the trigger source is set to BUS, the device waits for a software trigger and then executes the auto test. For EXT/ONCE, execution takes place after the start operation on the unit.

Command

```
INITiate[:IMMEDIATE]:TEST
```

MEASure/READ/FETCh Command

MEAS changes the TRIGger and SAMPlE subsystem settings to the values shown below, makes a new measurement, and then queries the measurement data. The present valid measurement data is invalidated.

Command	Value
TRIG:ACQ:SOUR	IMM
TRIG:ACQ:COUN	1
TRIG:ACQ:DEL	0.0
SAMP:TIM	0.0
SAMP:COUN	INF
SAMP:TEST:ENAB	ON

READ makes a new measurement and queries the measurement data. The present valid measurement data is invalidated.

FETC queries data that has already been measured. If there are multiple measurement data entries, the most recent data is returned.

-> [“Querying measured values”](#)(p. 333)

FETC/ READ/ MEAS

Queries the measurement data in the order specified by DATA:FORM.

-> [“Querying measured values”](#)(p. 333)

Command

FETCh?

READ?

MEASure?

Response

The response is returned in nr3,nr3,... format in the order specified by DATA:-FORM.

Unit: A (current), V (voltage), OHM (resistance), S (elapsed time), C (charge)

FETC:CIM/ READ:CIM/ MEAS:CIM

Queries the imaginary part of the current.

-> "Querying measured values"(p. 333)

Command

FETCh:CIImaginary?

READ:CIImaginary?

MEASure:CIImaginary?

Response: NR3

Unit: A

FETC:COUL/ READ:COUL/ MEAS:COUL

Queries the electric charge.

-> "Querying measured values"(p. 333)

Command

FETCh:COULomb?

READ:COULomb?

MEASure:COULomb?

Response: NR3

Unit: C

FETC:CRE/ READ:CRE/ MEAS:CRE

Queries the real part of the current.

-> "Querying measured values"(p. 333)

Command

FETCh:CREal?

READ:CREal?

MEASure:CREal?

Response: NR3

Unit: A

FETC:CURR/ READ:CURR/ MEAS:CURR

Queries the current.

-> "Querying measured values"(p. 333)

Command

FETCh:CURRent?

READ:CURRent?

MEASure:CURRent?

Response: NR3

Unit: A

FETC:ETIM/ READ:ETIM/ MEAS:ETIM

Queries the elapsed test time.

-> "Querying measured values"(p. 333)

Command

FETCh:ETIMe?

READ:ETIMe?

MEASure:ETIMe?

Response: NR3

Unit: S

FETC:RES/ READ:RES/ MEAS:RES

Queries the resistance.

-> "Querying measured values"(p. 333)

Command

FETCh:RESistance?

READ:RESistance?

MEASure:RESistance?

Response: NR3

Unit: OHM

FETC:VOLT/ READ:VOLT/ MEAS:VOLT

Queries the voltage.

-> "Querying measured values"(p. 333)

Command

FETCh:VOLTage?

READ:VOLTage?

MEASure:VOLTage?

Response: NR3

Unit: V

OUTPut Command

OUTP

Sets whether to output the temporary voltage in leakage current (TC/PCC/Patient) tests.

Command

```
OUTPut[:LINE][:STATe] <boolean>
```

```
OUTPut[:LINE][:STATe]?
```

Parameter

Value:	ON(1)	Output on
	OFF(0)	Output off (default)

Settings is reset to default when the *RST command is sent.

Response: NR1

Example

```
OUTP ON
```

OUTP:110P

Sets whether to output the voltage applied from the 110% terminal to the AC LINE IN inlet in meter tests.

Command

```
OUTPut[:TERMinal]:110Percent[:STATe] <boolean>
```

```
OUTPut[:TERMinal]:110Percent[:STATe]?
```

Parameter

Value:	ON(1)	Output on
	OFF(0)	Output off (default)

Settings is reset to default when the *RST command is sent.

Response: NR1

Example

```
OUTP:110P ON
```

OUTP:110P:POL

Sets the polarity of the voltage applied from the 110 % terminal in meter tests.

Command

```
OUTPut[:TERMinal]:110Percent:POLarity <character>
```

```
OUTPut[:TERMinal]:110Percent:POLarity?
```

Parameter

Value:	NORMAL	Normal phase (default)
	REVERSE	Reverse phase

Settings is reset to default when the *RST command is sent.

Response: character

Example

```
OUTP:110P:POL NORM
```

PROGram Command

PROG

Sets the program to be edited.

Specifying a blank program name ("") clears the selection.

Command

```
PROGram[:SElected] "<string>"
```

```
PROGram[:SElected]?
```

Parameter

For tests other than an LC test, include "/BASIC/" before the program name. For an LC test, include "/LC/".

When specifying a program in program memory, for tests other than an LC test, include "/SIGNAL IO/BASIC/" before the program name. For an LC test, include "/SIGNAL IO/LC/".

Response: string

Example: When specifying a test other than an LC test with the name "My test program"

```
PROG "/BASIC/My test program"
```

Example: When specifying an LC test 76

```
PROG "/SIGNAL IO/LC/76"
```

PROG:CRE

Creates a new program.

To edit a program, use PROG to specify the program to be edited after creating the program.

Command

```
PROG:CREate "<string>"
```

Parameter

Naming convention: Alphabet characters A-Za-z, numbers 0-9, dot (.), comma (,), parentheses (), brackets [], braces {}, and (&), dollar (\$), sharp (#), caret (^), percent (%), equal (=), hyphen (-), plus (+), underscore (_), space (), case-sensitive

Up to 255 characters

For tests other than an LC test, include "/BASIC/" before the program name. For an LC test, include "/LC/".

Example: When creating an LC test

```
PROG:CRE "/LC/My test program"
```

PROG:DEL

Deletes a program.

Command

```
PROG:DELEte "<string>"
```

Example

```
PROG:DEL "/BASIC/My test program"
```

PROG:INT:TIM

Sets the step interval time.

Command

```
PROG:SELected]:INTERval:TIMER <NRf>
```

```
PROG:SELected]:INTERval:TIMER?
```

Unit: S

Response: NR3

Example

```
PROG:INT:TIM 10S
```

PROG:FAIL:COUT

Sets the operation to be executed when a fail judgment occurs.

Command

```
PROGrama[:SElected][:JUDGment]:FAIL:CONTInue <boolean>
```

```
PROGrama[:SElected][:JUDGment]:FAIL:CONTInue?
```

Parameter

Value: ON(1) A fail judgment is indicated after the completion of all the steps.
OFF(0) Auto test ends when a failure occurs, and a fail judgment is indicated.

Response: NR1

Example

```
PROG:FAIL:COUT ON
```

PROG:LIST

Queries stored programs.

Command

```
PROGrama:LIST?
```

Response: "string","string"...

Returns "" if no programs are stored.

PROG:OUTP:CONT

Sets the power supply method after the completion of a step.

This is available only for the TOS9303LC.

Command

```
PROG:SElected[:LINE]:OUTPut:CONTinue <boolean>
```

```
PROG:SElected[:LINE]:OUTPut:CONTinue?
```

Parameter

Value: ON(1) Supplies power.
OFF(0) Shuts off power.

Response: NR1

Example

```
PROG:OUTP:CONT ON
```

PROG:REN

Changes the name of the selected program.

Command

```
PROG:SElected:REName "<string>"
```

Parameter

Naming convention: Alphabet characters A-Za-z, numbers 0-9, dot (.), comma (,), parentheses (), brackets [], braces {}, and (&), dollar (\$), sharp (#), caret (^), percent (%), equal (=), hyphen (-), plus (+), underscore (_), white space (), case-sensitive

Up to 255 characters

For tests other than an LC test, include "/BASIC/" before the program name. For an LC test, include "/LC/".

Example

```
PROG:REN "/BASIC/Your test program"
```

PROG:SAVE

Saves the selected program.

Command

PROG:SAVE

PROG:STEP<n>:<prog_item>

Sets the test condition indicated by <prog-item> to step n of the selected program.

For details on the parameters, see the test condition command of each test.

Use <n> to specify the step number. Step numbers start at 0.

Command

```
PROG:SELected]:STEP<n>:<prog-item>
```

```
PROG:SELected]:STEP<n>:<prog-item>?
```

<prog-item> list

<prog-item>	Description	Parameter	Applicable tests ¹
CONDition	Fault mode	character	TC/PCC/PAT
CONDition:FAULt	Disconnected condition at fault	character	TC/PCC/PAT
CURRent:FILTer:HPASs	High-pass filter	character	ACW/DCW
CURRent:FILTer:LPASs	Low-pass filter	character	ACW/DCW/IR
CURRent:FILTer:LPASs:STATe	Low-pass filter on/off	boolean	IR
CURRent:FILTer:TYPE	Filter type	character	ACW/DCW
[CURRent:]FREQuency	Test current frequency.	numeric	EC:AC
[CURRent:] ² [LEVel] ³	Test current	numeric	EC
CURRent:MODE	Current mode	character	TC/PCC/PAT
	Current measurement method	character	ACW
[CURRent]:SCALE:CONVert[:STATe]	Voltage conversion on/off	boolean	TC/PCC/PAT
[CURRent]:SCALE:CONVert:VOLTagE	Conversion voltage	numeric	TC/PCC/PAT
[CURRent:] ² SCALE:OFFSet:IMAGinary	Offset current (imaginary)	numeric	ACW
[CURRent:] ² SCALE:OFFSet[:REAL]	Offset current (real)	numeric	ACW/DCW/TC/ PCC/PAT
[CURRent:]SWEep:FALL:TIMer	Current fall time	numeric	EC
[CURRent:]SWEep:FALL:TIMer:STATe	Current fall time on and off	boolean	EC
[CURRent:]SWEep[:RISE]:TIMer	Voltage rise time	numeric	EC
[CURRent:]TIMer	Test time	numeric	EC
FUNction[:MODE]	Test mode	character	All
JUDGment[:CURRent] ² :LOWer	Lower limit	numeric	ACW/DCW/IR/ TC/PCC/PAT
JUDGment[:CURRent]:LOWer:STATe	Lower limit on/off	boolean	ACW/DCW/IR/ TC/PCC/PAT
JUDGment[:CURRent] ² [:UPPer]	Upper limit	numeric	ACW/DCW/IR/ TC/PCC/PAT
JUDGment:DELay	Judgment delay	numeric	DCW/IR/TC/ PCC/PAT
JUDGment:DELay:AUTO	Judgment delay auto on/off	boolean	DCW/IR
JUDGment:DELay:STATe	Judgment delay on/off	boolean	TC/PCC/PAT
JUDGment:RESistance:LOWer	Lower limit	numeric	IR/EC
JUDGment:RESistance:LOWer:STATe	Lower limit on/off	boolean	EC
JUDGment:RESistance[:UPPer]	Upper limit	numeric	IR/EC
JUDGment:RESistance[:UPPer]:STATe	Upper limit on/off	boolean	IR

<prog-item>	Description	Parameter	Applicable tests ^{*1}
JUDGment:TYPE	Judgment type	character	IR/EC
JUDGment[:VOLTage] ² :LOWer	Lower limit	numeric	EC
JUDGment[:VOLTage]:LOWer:STATe	Lower limit on/off	boolean	EC
JUDGment[:VOLTage] ² :UPPer]	Upper limit	numeric	EC
[LINE:]POLarity	Polarity of power supplied to EUT	character	TC/PCC/PAT
NETWork	Measurement circuit network	character	TC/PCC/PAT
NETWork:PROBe:A	A terminal probe connection destination	—	TC/PAT
NETWork:PROBe[:B]	B terminal probe connection destination	character	TC/PAT
SCALE[:STATe]	Offset on/off	boolean	All
[RESistance:] ² SCALE:OFFSet[:REAL]	Offset resistance	numeric	IR/EC
[ROUte:]TERMinal	Channel terminal connection	numeric, character	ACW/DCW/IR
[ROUte:]TERMinal:CCHeck[:STATe]	Channel continuity check on/off	boolean	ACW/DCW/IR
[TERMinal:]110Percent:OUTPut	110 output terminal voltage output on/off	boolean	TC/PAT
[TERMinal:]110Percent:POLarity	110 output terminal power supply polarity	character	TC/PAT
TERMinal:CCHeck[:STATe]	Contact check	boolean	EC
TERMinal:GROund	Grounding mode	character	ACW/DCW/IR
TERMinal:WIRE	4-terminal/2-terminal measurement	NR1	EC
TIMer	Test time	numeric	TC/PCC/PAT
[VOLTage:][:AC:]BANDwidth	Bandwidth	character	TC/PCC/PAT
[VOLTage:]DISCharge:TIMer[:MINimum]	Discharge time	numeric	DCW/IR
[VOLTage:]END:STATe	End voltage on/off	boolean	ACW/DCW
[VOLTage:]FREQuency	Test voltage frequency	numeric	ACW
[VOLTage:] ² [LEVel]	Test voltage	numeric	ACW/DCW/IR
VOLTage:MODE	Voltage measurement mode	character	ACW/DCW
[VOLTage:]RANGe	Output voltage range	numeric	IR
[VOLTage:]RANGe:AUTO	Output voltage range on/off	boolean	TC/PCC/PAT
[VOLTage:]STARt[:LEVel]	Start voltage	numeric	ACW/DCW/IR
[VOLTage:]STARt:STATe	Start voltage on/off	boolean	ACW/DCW/IR
[VOLTage:]SWEp:FALL:TIMer	Voltage fall time	numeric	ACW/DCW
[VOLTage:]SWEp:FALL:TIMer:STATe	Voltage fall time on/off	boolean	ACW/DCW
[VOLTage:]SWEp[:RISE]:TIMer	Voltage rise time	numeric	ACW/DCW/IR
[VOLTage:]TIMer	Test time	numeric	ACW/DCW/IR

*1. ACW: AC withstanding voltage, DCW: DC withstanding voltage, IR: insulation resistance, EC: earth continuity, TC: touch current, PCC: protective conductor current, PAT: patient leakage current

*2. Cannot be omitted when sending the command with a unit in the parameter.

*3. The abbreviated form [CURRENT:LEVEL] command is PROG:STEP<n>.

PROG:STEPS:COUN

Sets the number of steps of the selected program.

If the number is increased from the current number of steps, steps with default values are added after the last step. If the number is decreased, steps are deleted in order starting from the last step.

Command

```
PROGram[:SElected]:STEPS:COUNT <NRf>
```

```
PROGram[:SElected]:STEPS:COUNT?
```

Value: 1 to 100

Response: NR1

Returns +0 when no program is selected.

Example

```
PROG:STEPS:COUN 10
```

RESult command

RES:FORM

Sets the response format to use when test results are queried.

The response format uses RES? or RES:REM?.

The same parameter cannot be specified twice.

Command

```
RESult:FORMat <character>[,<character>[,<character>]...]
```

```
RESult:FORMat?
```

Parameter (1 minimum, 25 maximum)

Value	Description	Value	Description
NUMBer	Test number ^{*1}	CIMaginary	Imaginary part of the current at the time of judgment
STEP	Auto test step number	RESistance	Resistance at the time of judgment
FUNCTION	Test mode	COULomb	Electric charge at the time of judgment
DATE	Test start time ^{*2}	PULSe:COUNT	Pulse count at the time of judgment
YEAR	Test start date (year)	IVOLTage	Discharge inception voltage
MONTH	Test start date (month)	EVOLTage	Discharge extinction voltage
DAY	Test start date (day)	PCURrent	Maximum current during a test
HOURL	Test start time (hour)	PREStance	Minimum resistance during a test
MINute	Test start time (minute)	PCOULomb	Maximum electric charge during a test
SECond	Test start time (second)	ETIME	Test time at the time of judgment
VOLTage	Voltage at the time of judgment	JUDgment	Judgment result
CURRent	Current at the time of judgment	EJUDgment	Extended judgment result ^{*3}
CREal	Real part of the current at the time of judgment		

*1. Incremented each time a test is performed. Cleared to 0 when the count exceeds 2147483647.

*2. RFC2822 format

*3. The scanner channel(s) encountering an electrical continuity failure or the details of the protection function are also returned. For details, see the explanation of the RES commands.

Response: character,character,...

Example

```
RES:FORM NUMB,STEP,FUNC,DATE,VOLT,CURR,RES,ETIM,JUDG
```

Response example: When the test mode, test start time, and judgment result are set.

FUNC,DATE,JUDG is returned.

RES

Queries the previous test result.

A query does not clear the data. Use RES:FORM to specify the item to be queried.

Command

RESult[:IMMEDIATE]?

Response: Returns the item specified by RES:FORM in a comma-separated format. Returns +0 if no test results exist.

Item	Description	Response	
Test number	--	NR1	
Auto test step number	1 for a single test	NR1	
Test mode	ACW	AC withstanding voltage	character
	DCW	DC withstanding voltage	
	IR	Insulation resistance	
	ECAC	Earth continuity (AC)	
	ECDC	Earth continuity (DC)	
	PD	Partial discharge	
	TC-n ⁻¹	Touch current	
	PCC-n ⁻¹	Protective conductor current	
	PATIENT-n ⁻¹	Patient leakage current	
Test start time	RFC2822 format	"string"	
Test start date (year)	—	NR1	
Test start date (month)			
Test start date (day)			
Test start time (hour)			
Test start time (minute)			
Test start time (second)			
Pulse count at the time of judgment			
Voltage at the time of judgment	—	NR3	
Current at the time of judgment			
Real part of the current at the time of judgment			
Imaginary part of the current at the time of judgment			
Resistance at the time of judgment			
Test time at the time of judgment			
Test time at the time of judgment			

Item	Description		Response
Judgment result	PASS	PASS judgment.	character
Extended judgment result	U-FAIL	A value exceeding the upper limit was detected resulting in a FAIL judgment.	
	U-FAIL(dV/dt)	The voltage rise rate failed in a DC withstanding voltage test	
	L-FAIL	A value less than the lower limit was detected resulting in a FAIL judgment.	
	L-FAIL(dV/dt)	The voltage rise rate failed in an insulation resistance test	
	C-FAIL ^{*2}	An electrical continuity failed between scanner(s) and the EUT	
	C-FAIL(0xch ^{*3})		
	PROTECT ^{*2}	A protection function was activated, and the test was stopped.	
	PROTECT(factor ^{*4})		
ABORT	The test was aborted with a STOP signal.		

*1. n is the network name.

*2. Displayed only when JUDGment is selected by the RES:FORM command.

*3. This part is substituted by a value indicating a channel number in hexadecimal notation in the event of a failure in supplying power from the scanner to EUT in that channel. For details, see the 0xch channel information. The channel number is displayed only when EJUDgment is selected by the RES:FORM command.

*4. This part is substituted by a message indicating the generating factor of the activation of the protection function. For details, see the factor information. Displayed only when EJUDgment is selected by the RES:FORM command.

0xch channel information

If there is more than one channel encountering an electrical continuity failure, the channel numbers combined will be indicated.

0xCH	Channel	0xCH	Channel
0x0080	CH8(Scanner2-Ch4)	0x8000	CH16(Scanner4-Ch4)
0x0040	CH7(Scanner2-Ch3)	0x4000	CH15(Scanner4-Ch3)
0x0020	CH6(Scanner2-Ch2)	0x2000	CH14(Scanner4-Ch2)
0x0010	CH5(Scanner2-Ch1)	0x1000	CH13(Scanner4-Ch1)
0x0008	CH4(Scanner1-Ch4)	0x0800	CH12(Scanner3-Ch4)
0x0004	CH3(Scanner1-Ch3)	0x0400	CH11(Scanner3-Ch3)
0x0002	CH2(Scanner1-Ch2)	0x0200	CH10(Scanner3-Ch2)
0x0001	CH1(Scanner1-Ch1)	0x0100	CH9(Scanner3-Ch1)

factor information

If multiple factors have contributed to the activation of the protection function, the highest prioritized factor is returned.

factor	generating factor of the activation of the protection function		priority
ILOCK	Interlock	Interlock has been activated.	High
CAL	Calibration	The preset calibration period is exceeded.	↑
SIF	Scan I/F	While scanning, the interface cable is disconnected. The channel-assigned scanner is not detected.	↓
ORG	Over Range	A value exceeding the maximum value of the measurement range is detected.	Low
EF	Earth Fault	When the grounding mode is set to Guard, abnormal current flows from the high voltage output of this product to ground.	
RS	Relay Short	A relay operation error is detected in a leakage current test.	
PS	Power Supply	There is an error in the power supply section.	
MEAS	Measure	There is an error in the measurement check in a leakage current test.	
OUTERR	Output Error	An output voltage outside of the specified range is detected.	
OL	Over Load	An output power or current outside of the specified range is detected.	
OH	Over Heat	The internal temperature of the product is abnormally high.	
OR	Over Rating	During a withstanding voltage test, an output current is generated for a length of time that exceeds the output time limit.	
RMT	Remote	The REMOTE connector is connected or disconnected.	
SIO	Signal I/O	There is a change in the SIGNAL I/O connector's signals.	
COMM	Communication	An internal communication error is occurring. There has been no SCPI communication for a specified period of time or longer when the communication monitoring timer is used (SYST:COMM:PROT:WDOG ON).	

Response example: When a test mode, test start time (month), test start time (day), and judgment result are selected, a touch current test is executed on October 23 (IEC60990 figure 3 U1 measurement), and the result is PASS.

TC-A, 10, 23, PASS is returned.

Response example: When both a test start time (month) and a test start time (day) are specified and the extended judgment result is selected, if a test on October 23 resulted in an electrical continuity failure between the scanners (CH1, CH2, and CH5) and EUT,

10, 23, C-FAIL(0x0013) is returned.

Response example: When both a test start time (month) and a test start time (day) are specified and the extended judgment result is selected, if a test on October 23 terminated due to the activation of the protection function,

10, 23, PROTECT(ILOCK) is returned.

RES:COUN

Queries the number of test results stored in the product.

Command

RESult:COUNT?

Response: NR1

RES:REM

Queries the oldest test result.

The oldest test result is cleared when a query is made.

Use RES:FORM to specify the item to be queried.

Command

RESult:REMove?

Response Returns the item specified by RES:FORM in a comma-separated format.

For detail of response, see RES command (p. 128).

RES:TZON

Sets a test result time in UTC or time in the time zone specified by SYST:TZON.

Command

```
RESult[:DATetime]:TZONe <character>
```

```
RESult[:DATetime]:TZONe?
```

Parameter <character>

Value:	UTC	UTC (Coordinated Universal Time) (default)
	LOCal	Time in the time zone specified by SYST:TZON

Settings is reset to default when the *RST command is sent.

Response: character

Example

```
RES:TZON UTC
```

ROUTe Command

Use this function when the TOS9320 high voltage scanner option is connected.

ROUT:ACW:TERM

Sets the connection of each channel of the scanner in AC withstanding voltage tests.

The ACW in the second node can be omitted, but to distinguish it from the DC withstanding voltage test, we recommend that you do not.

Command

```
ROUTe[:ACW]:TERMinal <nrf>,<character>
```

```
ROUTe[:ACW]:TERMinal? <NRf>
```

Parameter <NRf>

Value: 101 to 104, 201 to 204, 301 to 304, 401 to 404

The hundreds digit is the scanner number (1 to 4), and the ones digit is the channel number (1 to 4). (default)

Parameter <character>

Value:	LOW	Low voltage side
	HIGH	High voltage side
	OPEN	Open (default)

Settings is reset to default when the *RST command is sent.

Response: character

Example

```
ROUT:ACW:TERM 202,LOW
```

```
ROUT:ACW:TERM? 202
```

ROUT:ACW:TERM:CCH

Sets the continuity check for the test leads connected to the scanner and the EUT in AC withstanding voltage tests.

The ACW in the second node can be omitted, but to distinguish it from the DC withstanding voltage test, we recommend that you do not.

Command

```
ROUTe[:ACW]:TERMinal:CCHeck[:STATe] <boolean>
```

```
ROUTe[:ACW]:TERMinal:CCHeck[:STATe]?
```

Parameter

Value: ON(1) Enable.
OFF(0) Disable. (default)

Settings is reset to default when the *RST command is sent.

Response: NR1

Example

```
ROUT:ACW:TERM:CCH ON
```

ROUT:CAT

Queries the available scanner channels.

Command

```
ROUTe:CATalog?
```

Response: NR1,NR1,...

ResponseExample: When a scanner is not connected

Returns +0.

ResponseExample: When scanner 1 (using channels 1 to 4) is connected

Returns +101,+102,+103,+104.

ROUT:DCW:TERM

Sets the connection of each channel of the scanner in DC withstanding voltage tests.

Command

```
ROUTe:DCW:TERMinal <nrf>,<character>
```

```
ROUTe:DCW:TERMinal? <NRf>
```

Parameter <NRf>

Value: 101 to 104, 201 to 204, 301 to 304, 401 to 404

The hundreds digit is the scanner number (1 to 4), and the ones digit is the channel number (1 to 4).

Parameter <character>

Value:	LOW	Low voltage side
	HIGH	High voltage side
	OPEN	Open (default)

Settings is reset to default when the *RST command is sent.

Response: character

Example

```
ROUT:DCW:TERM 202,LOW
```

```
ROUT:DCW:TERM? 202
```

ROUT:DCW:TERM:CCH

Sets the continuity check for the test leads connected to the scanner and the EUT in DC withstanding voltage tests.

Command

```
ROUTe:DCW:TERMinal:CCHeck[:STATE] <boolean>
```

```
ROUTe:DCW:TERMinal:CCHeck[:STATE]?
```

Parameter

Value: ON(1) Enable.
 OFF(0) Disable. (default)

Settings is reset to default when the *RST command is sent.

Response: NR1

Example

```
ROUT:DCW:TERM:CCH ON
```

ROUT:IR:TERM

Sets the connection of each channel of the scanner in insulation resistance tests.

Command

```
ROUTe:IR:TERMinal <nrf>,<character>
```

```
ROUTe:IR:TERMinal? <NRf>
```

Parameter <NRf>

Value: 101 to 104, 201 to 204, 301 to 304, 401 to 404

The hundreds digit is the scanner number (1 to 4), and the ones digit is the channel number (1 to 4).

Parameter <character>

Value:	LOW	Low voltage side
	HIGH	High voltage side
	OPEN	Open (default)

Settings is reset to default when the *RST command is sent.

Response: character

Example

```
ROUT:IR:TERM 202,LOW
```

```
ROUT:IR:TERM? 202
```

ROUT:IR:TERM:CCH

Sets the continuity check for the test leads connected to the scanner and the EUT in insulation resistance tests.

Command

```
ROUTe:IR:TERMinal:CCheck[:STATe] <boolean>
```

```
ROUTe:IR:TERMinal:CCheck[:STATe]?
```

Parameter

Value: ON(1) Enable.
 OFF(0) Disable.

Response: NR1

Example

```
ROUT:IR:TERM:CCH ON
```

ROUT:TERM:CONT:FAIL

Returns the channel(s) encountering Contact-FAIL.

Command

```
ROUTe:TERMinals:CONTact:FAIL?
```

Response: NR1,NR1,...

If there is no test result or no Contact-FAIL occurring, +0 is returned.

SAMPlE command

This is a subsystem for setting conditions for obtaining sample measured value.

The acquisition time varies according to the test mode and frequency setting.

Test mode	Frequency	acquisition time
AC withstanding voltage	50 Hz	20 ms (1/50 s)
Earth continuity (AC) Partial discharge	60Hz	16.67 ms (1/60 s)
DC withstanding voltage Insulation resistance Earth continuity (DC)	50Hz/ 60 Hz	100 ms
Leakage current	50Hz/ 60 Hz	1000 ms

SAMP:COUNT

Sets the number of measured value samples you want to obtain.

Command

```
SAMPlE:COUNT {<numeric>|<character>}
```

```
SAMPlE:COUNT?
```

Parameter

Value: 1 to 8192

INFinity Continue obtaining measurement samples until the test is terminated. (default)

Setting is reset to default when the *RST or MEAS command is sent.

When the local mode is enabled with the LOCAL key or by sending the SYST:COMM:RLST LOC command, the setting is reset to its original default.

Response: NR1 or character

Example

```
SAMP:COUNT 10
```

SAMP:TEST:ENAB

Sets whether to obtain measurement samples even while the test is not performed. When ON is selected, no measurement sample is taken while the test is not performed. If a test is terminated while measurement samples are being recorded, even if the preset sampling count has not been reached, the remaining sampling will be skipped.

Command

```
SAMPle:TESTing:ENABle <boolean>
```

```
SAMPle:TESTing:ENABle?
```

Parameter

Value: ON(1) The acquisition of measurement samples is skipped while a test is not performed. (default)
OFF(0) The specified number of measurement samples is taken at all times.

Setting is reset to default when the *RST or MEAS command is sent.

When the local mode is enabled with the LOCAL key or by sending the SYST:COM-M:RLST LOC command, the setting is reset to its original default.

Response: NR1

Example

```
SAMP:TEST:ENAB ON
```

SAMP:TIM

Sets a sampling interval.

If the preset sampling interval is shorter than the recording time, the acquisition of a new measurement sample starts immediately after the ongoing sampling finishes.

Command

```
SAMPle:TIMer <numeric>
```

```
SAMPle:TIMer?
```

Parameter

Value: 0.0 to 10.0 (0 by default)

Unit: S

Resolution: 100 ms	AC withstanding voltage
	DC withstanding voltage
	Insulation resistance
	Earth continuity
	Partial discharge
1 s	Leakage current

Setting is reset to default when the *RST or MEAS command is sent.

When the local mode is enabled with the LOCAL key or by sending the SYST:COM-M:RLST LOC command, the setting is reset to its original default.

Response: NR3

Example

```
SAMP:TIM 0.2S
```

SENSe:ACW Command

This is a subsystem for setting the AC withstanding voltage test (ACW) conditions. The ACW in the second node can be omitted, but to distinguish it from the DC withstanding voltage test, we recommend that you do not.

SENS:ACW:CURR:FILT:HPAS

Sets the high-pass filter for AC withstanding voltage tests.

Command

```
SENSe[:ACW]:CURRent:FILTer:HPASs <character>
```

```
SENSe[:ACW]:CURRent:FILTer:HPASs?
```

Parameter

Value: SLOW (default)
FAST

Settings is reset to default when the *RST command is sent.

Response: character

Example

```
SENS:ACW:CURR:FILT:HPAS SLOW
```

Related command

```
SENS:ACW:CURR:FILT:TYPE
```

SENS:ACW:CURR:FILT:LPAS

Sets the low-pass filter for AC withstanding voltage tests.

Command

```
SENSe[:ACW]:CURRent:FILTer:LPASs <character>
```

```
SENSe[:ACW]:CURRent:FILTer:LPASs?
```

Parameter

Value: SLOW (default)
MEDIUm
FAST

Settings is reset to default when the *RST command is sent.

Response: character

Example

```
SENS:ACW:CURR:FILT:LPAS SLOW
```

Related command

```
SENS:ACW:CURR:FILT:TYPE
```

SENS:ACW:CURR:FILT:TYPE

Sets the filter type for AC withstanding voltage tests.

Command

```
SENSe[:ACW]:CURRent:FILTer:TYPE <character>
```

```
SENSe[:ACW]:CURRent:FILTer:TYPE?
```

Parameter

Value:	LOW	Low-pass filter (default)
	HIGH	High-pass filter

Settings is reset to default when the *RST command is sent.

Response: character

Example

```
SENS:ACW:CURR:FILT:TYPE LOW
```

SENSe:ACW:CURR:MODE

Sets the current measurement mode in AC withstanding voltage tests.

Command

```
SENSe[:ACW]:CURRent:MODE <character>
```

```
SENSe[:ACW]:CURRent:MODE?
```

Parameter

Value:	RMS	True rms value (default)
	AVERAge	Convert mean-value responses to rms values

Settings is reset to default when the *RST command is sent.

Response: character

Example

```
SENSe:ACW:CURR:MODE RMS
```

SENSe:ACW:JUDG

Sets the reference current for upper limit judgment in AC withstanding voltage tests.

Command

```
SENSe[:ACW]:JUDGment[:CURRent][:UPPer] <numeric>
```

```
SENSe[:ACW]:JUDGment[:CURRent][:UPPer]?
```

Unit: A

Settings is reset to default when the *RST command is sent. (0.01 MA)

Response: NR3

Example

```
SENSe:ACW:JUDG 0.00002
```

SENS:ACW:JUDG:LOW

Sets the reference current for the lower limit judgment in AC withstanding voltage tests.

This setting is enabled when SENS:JUDG:LOW:STAT is set to ON.

Command

```
SENSe[:ACW]:JUDGment[:CURRent]:LOWer <numeric>
```

```
SENSe[:ACW]:JUDGment[:CURRent]:LOWer?
```

Unit: A

Settings is reset to default when the *RST command is sent. (0 A)

Response: NR3

Example

```
SENS:ACW:JUDG:LOW 10UA
```

SENS:ACW:JUDG:LOW:STAT

Sets whether to judge with the lower limit in AC withstanding voltage tests.

Use SENS:JUDG:LOW to set the lower limit.

Command

```
SENSe[:ACW]:JUDGment[:CURRent]:LOWer:STATe <boolean>
```

```
SENSe[:ACW]:JUDGment[:CURRent]:LOWer:STATe?
```

Parameter

Value: ON(1) Judge
OFF(0) Not judge (default)

Settings is reset to default when the *RST command is sent.

Response: NR1

Example

```
SENS:ACW:JUDG:LOW:STAT ON
```

SENSe:ACW:TERM:GRO

Sets whether to measure by including or excluding the current running through the stray capacitance in AC withstanding voltage tests.

Command

```
SENSe[:ACW]:TERMinal:GROund <character>
```

```
SENSe[:ACW]:TERMinal:GROund?
```

Parameter

Value:	LOW	Measure including the current running through the stray capacitance (default)
	GUARd	Measure excluding the current running through the stray capacitance

Settings is reset to default when the *RST command is sent.

Response: character

Example

```
SENS:ACW:TERM:GRO LOW
```

SENSe:ACW:VOLT:MODE

Sets the voltage measurement mode in AC withstanding voltage tests.

Command

```
SENSe[:ACW]:VOLTage:MODE <character>
```

```
SENSe[:ACW]:VOLTage:MODE?
```

Parameter

Value:	RMS	True rms value (default)
	PEAK	Peak value

Settings is reset to default when the *RST command is sent.

Response: character

Example

```
SENS:ACW:VOLT:MODE PEAK
```

SENSe:DCW Command

This is a subsystem for setting the DC withstanding voltage test (DCW) conditions.

SENSe:DCW:CURR:FILT:HPAS

Sets the high-pass filter for DC withstanding voltage tests.

Command

```
SENSe:DCW:CURRent:FILTer:HPASs <character>
```

```
SENSe:DCW:CURRent:FILTer:HPASs?
```

Parameter

Value: SLOW (default)
FAST

Settings is reset to default when the *RST command is sent.

Response: character

Example

```
SENS:DCW:CURR:FILT:HPAS SLOW
```

Related command

```
SENS:DCW:CURR:FILT:TYPE
```

SENSe:DCW:CURR:FILT:LPAS

Sets the low-pass filter for DC withstanding voltage tests.

Command

```
SENSe:DCW:CURRent:FILTer:LPASs <character>
```

```
SENSe:DCW:CURRent:FILTer:LPASs?
```

Parameter

Value: SLOW (default)
MEDIum
FAST

Settings is reset to default when the *RST command is sent.

Response: character

Example

```
SENSe:DCW:CURR:FILT:LPAS SLOW
```

Related command

```
SENSe:DCW:CURR:FILT:TYPE
```

SENS:DCW:CURR:FILT:TYPE

Sets the filter type for DC withstanding voltage tests.

Command

```
SENSe:DCW:CURRent:FILTer:TYPE <character>
```

```
SENSe:DCW:CURRent:FILTer:TYPE?
```

Parameter

Value:	LOW	Low-pass filter (default)
	HIGH	High-pass filter

Settings is reset to default when the *RST command is sent.

Response: character

Example

```
SENS:DCW:CURR:FILT:TYPE LOW
```

SENS:DCW:JUDG

Sets the reference current for upper limit judgment in DC withstanding voltage tests.

Command

```
SENSe:DCW:JUDGment[:CURRent][:UPPer] <numeric>
```

```
SENSe:DCW:JUDGment[:CURRent][:UPPer]?
```

Unit: A

Settings is reset to default when the *RST command is sent. (0.01 MA)

Response: NR3

Example

```
SENS:DCW:JUDG 0.00002
```

SENSe:DCW:JUDG:DEL

Sets the delay time until starting upper limit judgment in DC withstanding voltage tests.

This setting is enabled when SENSe:DCW:JUDG:DEL:AUTO is set to OFF.

Command

```
SENSe:DCW:JUDGment:DELay <numeric>
```

```
SENSe:DCW:JUDGment:DELay?
```

Unit: S

Settings is reset to default when the *RST command is sent. (0.1 S)

Response: NR3

Example

```
SENSe:DCW:JUDG:DEL 500MS
```

SENSe:DCW:JUDG:DEL:AUTO

Sets whether to make the judgment delay automatic in DC withstanding voltage tests.

If you do not set it to automatic, set the time until starting judgment with SENSe:DCW:JUDG:DEL.

Command

```
SENSe:DCW:JUDGment:DELay:AUTO <boolean>
```

```
SENSe:DCW:JUDGment:DELay:AUTO?
```

Parameter

Value:	ON(1)	Set it to automatic
	OFF(0)	Not set it to automatic (default)

Settings is reset to default when the *RST command is sent.

Response: NR1

Example

```
SENSe:DCW:JUDG:DEL:AUTO ON
```

SENS:DCW:JUDG:LOW

Sets the reference current for the lower limit judgment in DC withstanding voltage tests.

This setting is enabled when SENS:DCW:JUDG:LOW:STAT is set to ON.

Command

```
SENSe:DCW:JUDGment[:CURRent]:LOWer <numeric>
```

```
SENSe:DCW:JUDGment[:CURRent]:LOWer?
```

Unit: A

Settings is reset to default when the *RST command is sent. (0 A)

Response: NR3

Example

```
SENS:DCW:JUDG:LOW 10UA
```

SENS:DCW:JUDG:LOW:STAT

Sets whether to judge with the lower limit in DC withstanding voltage tests.

Use SENS:DCW:JUDG:LOW to set the lower limit.

Command

```
SENSe:DCW:JUDGment[:CURRent]:LOWer:STATe <boolean>
```

```
SENSe:DCW:JUDGment[:CURRent]:LOWer:STATe?
```

Parameter

Value: ON(1) Judge
OFF(0) Not judge (default)

Settings is reset to default when the *RST command is sent.

Response: NR1

Example

```
SENS:DCW:JUDG:LOW:STAT OFF
```

SENSe:DCW:TERM:GRO

Sets whether to measure by including or excluding the current running through the stray capacitance in DC withstanding voltage tests.

Command

```
SENSe:DCW:TERMinal:GROund <character>
```

```
SENSe:DCW:TERMinal:GROund?
```

Parameter

Value:	LOW	Measure including the current running through the stray capacitance (default)
	GUARd	Measure excluding the current running through the stray capacitance

Settings is reset to default when the *RST command is sent.

Response: character

Example

```
SENS:DCW:TERM:GRO GUAR
```

SENSe:DCW:VOLT:MODE

Sets the voltage measurement mode in DC withstanding voltage tests.

Command

```
SENSe:DCW:VOLTage:MODE <character>
```

```
SENSe:DCW:VOLTage:MODE?
```

Parameter

Value:	PEAK	Peak value
	AVERAge	Mean value (default)

Settings is reset to default when the *RST command is sent.

Response: character

Example

```
SENS:DCW:VOLT:MODE PEAK
```

SENSe:EC Command

This is a subsystem for setting the earth continuity test (EC) conditions.

SENS:EC[:AC] Command

SENSe:EC:JUDG

Sets the reference resistance for upper limit judgment in earth continuity tests (AC).

This setting is enabled when SENS:EC:JUDG:STAT is set to ON.

Command

```
SENSe:EC[:AC]:JUDGment[:RESistance][:UPPer] <numeric>
```

```
SENSe:EC[:AC]:JUDGment[:RESistance][:UPPer]?
```

Unit: OHM

Settings is reset to default when the *RST command is sent. (0.0001 OHM)

Response: NR3

Example

```
SENS:EC:JUDG 0.0002
```

SENSe:EC:JUDG:STAT

Sets whether to judge with the upper resistance limit in earth continuity tests (AC).

This setting is enabled when SENSe:EC:JUDG:TYPE is set to RES.

Use SENSe:EC:JUDG:LOW to set the upper limit.

Command

```
SENSe:EC[:AC]:JUDGment[:RESistance][:UPPer]:STATe <bool-
  ean> SENSe:EC[:AC]:JUDGment[:RESistance][:UPPer]:STATe?
```

Parameter

Value: ON(1) Judge (default)
OFF(0) Not judge

Settings is reset to default when the *RST command is sent.

Response: NR1

Example

```
SENSe:EC:JUDG:STAT ON
```

SENS:EC:JUDG:LOW

Sets the reference resistance for lower limit judgment in earth continuity tests (AC).
This setting is enabled when SENS:EC:JUDG:LOW:STAT is set to ON.

Command

```
SENSe:EC[:AC]:JUDGment[:RESistance]:LOWer <numeric>  
SENSe:EC[:AC]:JUDGment[:RESistance]:LOWer?
```

Unit: OHM

Settings is reset to default when the *RST command is sent. (0 OHM)

Response: NR3

Example

```
SENS:EC:JUDG:LOW 1
```

SENS:EC:JUDG:LOW:STAT

Sets whether to judge with the lower resistance limit in earth continuity tests (AC).
This setting is enabled when SENS:EC:JUDG:TYPE is set to RES.
Use SENS:EC:JUDG:LOW to set the lower limit.

Command

```
SENSe:EC[:AC]:JUDGment[:RESistance]:LOWer:STATe <boolean>  
SENSe:EC[:AC]:JUDGment[:RESistance]:LOWer:STATe?
```

Parameter

Value: ON(1) Judge
OFF(0) Not judge (default)

Settings is reset to default when the *RST command is sent.

Response: NR1

Example

```
SENS:EC:JUDG:LOW:STAT ON
```

SENSe:EC:JUDG:TYPE

Sets whether to use resistance or voltage to make upper limit judgment and lower limit judgment in earth continuity tests (AC).

Command

```
SENSe:EC[:AC]:JUDGment:TYPE <character>
```

```
SENSe:EC[:AC]:JUDGment:TYPE?
```

Parameter

Value: RESistance Judge using resistance (default)
 VOLTage Judge using voltage

Settings is reset to default when the *RST command is sent.

Response: character

Example

```
SENSe:EC:JUDG:TYPE RES
```

SENS:EC:JUDG:VOLT

Sets the reference voltage for upper limit judgment in earth continuity tests (AC).
This setting is enabled when SENS:EC:VOLT:JUDG:STAT is set to ON.

Command

```
SENSe:EC[:AC]:JUDGment:VOLTage[:UPPer] <numeric>  
SENSe:EC[:AC]:JUDGment:VOLTage[:UPPer]?
```

Unit: V

Settings is reset to default when the *RST command is sent. (2.5 V)

Response: NR3

Example

```
SENS:EC:JUDG:VOLT 0.002
```

SENS:EC:JUDG:VOLT:STAT

Sets whether to judge with the upper voltage limit in earth continuity tests (AC).
This setting is enabled when SENS:EC:JUDG:TYPE is set to VOLT.
Use SENS:EC:VOLT:JUDG to set the upper limit.

Command

```
SENSe:EC[:AC]:JUDGment:VOLTage[:UPPer]:STATe <boolean>  
SENSe:EC[:AC]:JUDGment:VOLTage[:UPPer]:STATe?
```

Parameter

Value: ON(1) Judge (default)
OFF(0) Not judge

Settings is reset to default when the *RST command is sent.

Response: NR1

Example

```
SENS:EC:JUDG:VOLT:STAT ON
```

SENSe:EC:JUDG:VOLT:LOW

Sets the reference voltage for lower limit judgment in earth continuity tests (AC).
This setting is enabled when SENSe:EC:VOLT:JUDG:LOW:STAT is set to ON.

Command

```
SENSe:EC[:AC]:JUDGment:VOLTage:LOWer <numeric>
SENSe:EC[:AC]:JUDGment:VOLTage:LOWer?
```

Unit: V

Settings is reset to default when the *RST command is sent. (0 V)

Response: NR3

Example

```
SENSe:EC:JUDG:VOLT:LOW 1V
```

SENSe:EC:JUDG:VOLT:LOW:STAT

Sets whether to judge with the lower voltage limit in earth continuity tests (AC).
This setting is enabled when SENSe:EC:JUDG:TYPE is set to VOLT.
Use SENSe:EC:VOLT:JUDG:LOW to set the lower limit.

Command

```
SENSe:EC[:AC]:JUDGment:VOLTage:LOWer:STATe <boolean>
SENSe:EC[:AC]:JUDGment:VOLTage:LOWer:STATe?
```

Parameter

Value: ON(1) Judge
OFF(0) Not judge (default)

Settings is reset to default when the *RST command is sent.

Response: NR1

Example

```
SENSe:EC:JUDG:VOLT:LOW:STAT ON
```

SENS:EC:TERM:CCH

Sets the contact check for the test leads and the EUT in earth continuity tests (AC).

Command

```
SENSe:EC[:AC]:TERMinal:CCHeck[:STATe] <boolean>
```

```
SENSe:EC[:AC]:TERMinal:CCHeck[:STATe]?
```

Parameter

Value: ON(1) Check is performed.
OFF(0) Check is not performed. (default)

Settings is reset to default when the *RST command is sent.

Response: NR1

Example

```
SENS:EC:TERM:CCH ON
```

SENS:EC:TERM:WIRE

Sets the test lead wiring method in earth continuity tests (AC).

Command

```
SENSe:EC[:AC]:TERMinal:WIRE {4|2}
```

```
SENSe:EC[:AC]:TERMinal:WIRE?
```

Parameter

Value: 4 Four-terminal wiring (default)
2 Two-terminal wiring

Settings is reset to default when the *RST command is sent.

Response: NR1

Example

```
SENS:EC:TERM:WIRE 2
```

SENS:EC:DC Command

SENS:EC:DC:JUDG

Sets the reference resistance for upper limit judgment in earth continuity tests (DC). This setting is enabled when SENS:EC:DC:JUDG:STAT is set to ON.

Command

```
SENSe:EC:DC:JUDGment[:RESistance][:UPPer] <numeric>
SENSe:EC:DC:JUDGment[:RESistance][:UPPer]?
```

Unit: OHM

Settings is reset to default when the *RST command is sent. (0.0001 OHM)

Response: NR3

Example

```
SENS:EC:DC:JUDG 0.00002
```

SENS:EC:DC:JUDG:STAT

Sets whether to judge with the upper resistance limit in earth continuity tests (DC). This setting is enabled when SENS:EC:DC:JUDG:TYPE is set to RES. Use SENS:EC:DC:JUDG:LOW to set the upper limit.

Command

```
SENSe:EC:DC:JUDGment[:RESistance][:UPPer]:STATe <boolean>
SENSe:EC:DC:JUDGment[:RESistance][:UPPer]:STATe?
```

Parameter

Value: ON(1) Judge (default)
OFF(0) Not judge

Settings is reset to default when the *RST command is sent.

Response: NR1

Example

```
SENS:EC:DC:JUDG:STAT ON
```

SENS:EC:DC:JUDG:LOW

Sets the reference resistance for lower limit judgment in earth continuity tests (DC).
This setting is enabled when SENS:EC:DC:JUDG:LOW:STAT is set to ON.

Command

```
SENSe:EC:DC:JUDGment[:RESistance]:LOWer <numeric>  
SENSe:EC:DC:JUDGment[:RESistance]:LOWer?
```

Unit: OHM

Settings is reset to default when the *RST command is sent. (0 OHM)

Response: NR3

Example

```
SENS:EC:DC:JUDG:LOW 10
```

SENS:EC:DC:JUDG:LOW:STAT

Sets whether to judge with the lower resistance limit in earth continuity tests (DC).
This setting is enabled when SENS:EC:DC:JUDG:TYPE is set to RES.
Use SENS:EC:DC:JUDG:LOW to set the lower limit.

Command

```
SENSe:EC:DC:JUDGment[:RESistance]:LOWer:STATe <boolean>  
SENSe:EC:DC:JUDGment[:RESistance]:LOWer:STATe?
```

Parameter

Value: ON(1) Judge
OFF(0) Not judge (default)

Settings is reset to default when the *RST command is sent.

Response: NR1

Example

```
SENS:EC:DC:JUDG:LOW:STAT ON
```

SENSe:EC:DC:JUDG:TYPE

Sets whether to use resistance or voltage to make upper limit judgment and lower limit judgment in earth continuity tests (DC).

Command

```
SENSe:EC:DC:JUDGment:TYPE <character>
```

```
SENSe:EC:DC:JUDGment:TYPE?
```

Parameter

Value: RESistance Judge using resistance (default)
 VOLTage Judge using voltage

Settings is reset to default when the *RST command is sent.

Response: character

Example

```
SENSe:EC:DC:JUDG:TYPE RES
```

SENS:EC:DC:JUDG:VOLT

Sets the reference voltage for upper limit judgment in earth continuity tests (DC).
This setting is enabled when SENS:EC:DC:VOLT:JUDG:STAT is set to ON.

Command

```
SENSe:EC:DC:JUDGment:VOLTage[:UPPer] <numeric>  
SENSe:EC:DC:JUDGment:VOLTage[:UPPer]?
```

Unit: V

Settings is reset to default when the *RST command is sent. (2.5 V)

Response: NR3

Example

```
SENS:EC:DC:JUDG:VOLT 0.002
```

SENS:EC:DC:JUDG:VOLT:STAT

Sets whether to judge with the upper voltage limit in earth continuity tests (DC).
This setting is enabled when SENS:EC:DC:JUDG:TYPE is set to VOLT.
Use SENS:DC:EC:VOLT:JUDG to set the upper limit.

Command

```
SENSe:EC:DC:JUDGment:VOLTage[:UPPer]:STATe <boolean>  
SENSe:EC:DC:JUDGment:VOLTage[:UPPer]:STATe?
```

Parameter

Value: ON(1) Judge (default)
OFF(0) Not judge

Settings is reset to default when the *RST command is sent.

Response: NR1

Example

```
SENS:EC:DC:JUDG:VOLT:STAT ON
```

SENS:EC:DC:JUDG:VOLT:LOW

Sets the reference voltage for lower limit judgment in earth continuity tests (DC).
This setting is enabled when SENS:EC:DC:VOLT:JUDG:LOW:STAT is set to ON.

Command

```
SENSe:EC:DC:JUDGment:VOLTagE:LOWer <numeric>
SENSe:EC:DC:JUDGment:VOLTagE:LOWer?
```

Unit: V

Settings is reset to default when the *RST command is sent. (0 V)

Response: NR3

Example

```
SENS:EC:DC:JUDG:VOLT:LOW 1V
```

SENS:EC:DC:JUDG:VOLT:LOW:STAT

Sets whether to judge with the lower voltage limit in earth continuity tests (DC).
This setting is enabled when SENS:EC:DC:JUDG:TYPE is set to VOLT.
Use SENS:EC:DC:VOLT:JUDG:LOW to set the lower limit.

Command

```
SENSe:EC:DC:JUDGment:VOLTagE:LOWer:STATe <boolean>
SENSe:EC:DC:JUDGment:VOLTagE:LOWer:STATe?
```

Parameter

Value: ON(1) Judge
OFF(0) Not judge (default)

Settings is reset to default when the *RST command is sent.

Response: NR1

Example

```
SENS:EC:DC:JUDG:VOLT:LOW:STAT ON
```

SENS:EC:DC:TERM:CCH

Sets the continuity check for the test leads and the EUT in earth continuity tests (DC).

Command

```
SENSe:EC:DC:TERMinal:CCHeck[:STATe] <boolean>
```

```
SENSe:EC:DC:TERMinal:CCHeck[:STATe]?
```

Parameter

Value: ON(1) Check is performed.
OFF(0) Check is not performed. (default)

Settings is reset to default when the *RST command is sent.

Response: NR1

Example

```
SENS:EC:DC:TERM:CCH ON
```

SENS:EC:DC:TERM:WIRE

Sets the test lead wiring method in earth continuity tests (DC).

Command

```
SENSe:EC:DC:TERMinal:WIRE {4|2}
```

```
SENSe:EC:DC:TERMinal:WIRE?
```

Parameter

Value: 4 Four-terminal wiring (default)
2 Two-terminal wiring

Settings is reset to default when the *RST command is sent.

Response: NR1

Example

```
SENS:EC:DC:TERM:WIRE 2
```

SENSe:IR Command

This is a subsystem for setting the insulation resistance test (IR) conditions.

SENS:IR:CURR:FILT:LPAS:STAT

Enables or disables the low-pass filter for insulation resistance tests.

Command

```
SENSe:IR:CURRent:FILTer:LPASs:STATe <boolean>
```

```
SENSe:IR:CURRent:FILTer:LPASs:STATe?
```

Parameter

Value: ON(1) The low-pass filter is enabled.
OFF(0) The low-pass filter is disabled. (default)

Settings is reset to default when the *RST command is sent.

Response: NR1

Example

```
SENS:IR:CURR:FILT:LPAS:STAT ON
```

SENS:IR:JUDG

Sets the reference resistance for upper limit judgment in insulation resistance tests.
This setting is enabled when SENS:IR:JUDG:STAT is set to ON.

Command

```
SENSe:IR:JUDGment[:RESistance][:UPPer] <numeric>  
SENSe:IR:JUDGment[:RESistance][:UPPer]?
```

Unit: OHM

Settings is reset to default when the *RST command is sent. (100 MOHM)

Response: NR3

Example

```
SENS:IR:JUDG 100MOHM
```

SENS:IR:JUDG:STAT

Sets whether to judge with the upper resistance limit in insulation resistance tests.
This setting is enabled when SENS:IR:JUDG:TYPE is set to RES.
Use SENS:IR:JUDG to set the upper limit.

Command

```
SENSe:IR:JUDGment[:RESistance][:UPPer]:STATe <boolean>  
SENSe:IR:JUDGment[:RESistance][:UPPer]:STATe?
```

Parameter

Value: ON(1) Judge
OFF(0) Not judge (default)

Settings is reset to default when the *RST command is sent.

Response: NR1

Example

```
SENS:IR:JUDG:STAT ON
```

SENSe:IR:JUDG:CURR

Sets the reference current for upper limit judgment in insulation resistance tests.

This setting is enabled when SENSe:IR:JUDG:CURR:STAT is set to ON.

Command

```
SENSe:IR:JUDGment:CURRent[:UPPer] <numeric>
```

```
SENSe:IR:JUDGment:CURRent[:UPPer]?
```

Unit: A

Settings is reset to default when the *RST command is sent. (0.0001 MA)

Response: NR3

Example

```
SENSe:IR:JUDG:CURR 1MA
```

SENSe:IR:JUDG:CURR:STAT

Sets whether to judge with the upper current limit in insulation resistance tests.

This setting is enabled when SENSe:IR:JUDG:TYPE is set to CURR.

Use SENSe:IR:JUDG:CURR to set the upper limit.

Command

```
SENSe:IR:JUDGment:CURRent[:UPPer]:STATe <boolean>
```

```
SENSe:IR:JUDGment:CURRent[:UPPer]:STATe?
```

Parameter

Value: ON(1) Judge (default)
OFF(0) Not judge

Settings is reset to default when the *RST command is sent.

Response: NR1

Example

```
SENSe:IR:JUDG:CURR:STAT ON
```

SENS:IR:JUDG:CURR:LOW

Sets the reference current for lower limit judgment in insulation resistance tests.
This setting is enabled when SENS:IR:JUDG:CURR:LOW:STAT is set to ON.

Command

```
SENSe:IR:JUDGment:CURRent:LOWer <numeric>  
SENSe:IR:JUDGment:CURRent:LOWer?
```

Unit: A

Settings is reset to default when the *RST command is sent. (0 A)

Response: NR3

Example

```
SENS:IR:JUDG:CURR:LOW 1MA
```

SENS:IR:JUDG:CURR:LOW:STAT

Sets whether to judge with the lower current limit in insulation resistance tests.
This setting is enabled when SENS:IR:JUDG:TYPE is set to CURR.
Use SENS:IR:JUDG:CURR:LOW to set the lower limit.

Command

```
SENSe:IR:JUDGment:CURRent:LOWer:STATe <boolean>  
SENSe:IR:JUDGment:CURRent:LOWer:STATe?
```

Parameter

Value: ON(1) Judge
OFF(0) Not judge (default)

Settings is reset to default when the *RST command is sent.

Response: NR1

Example

```
SENS:IR:JUDG:CURR:LOW:STAT ON
```

SENS:IR:JUDG:DEL

Sets the time until starting upper limit judgment.

This setting is enabled when SENS:IR:JUDG:DEL:AUTO? is set to OFF.

Command

```
SENSe:IR:JUDGment:DELay <numeric>
```

```
SENSe:IR:JUDGment:DELay?
```

Unit: S

Settings is reset to default when the *RST command is sent. (0.1 S)

Response: NR3

Example

```
SENS:IR:JUDG:DEL 2
```

SENS:IR:JUDG:DEL:AUTO

Sets whether to make the judgment delay automatic.

If you do not set it to automatic, set the time until starting judgment with SENS:IR:-JUDG:DEL.

Command

```
SENSe:IR:JUDGment:DELay:AUTO <boolean>
```

```
SENSe:IR:JUDGment:DELay:AUTO?
```

Parameter

Value: ON(1) Set it to automatic
OFF(0) Not set it to automatic (default)

Settings is reset to default when the *RST command is sent.

Response: NR1

Example

```
SENS:IR:JUDG:DEL:AUTO ON
```

SENS:IR:JUDG:LOW

Sets the reference resistance for lower limit judgment in insulation resistance tests.
This setting is enabled when SENS:IR:JUDG:LOW:STAT is set to ON.

Command

```
SENSe:IR:JUDGment[:RESistance]:LOWer <numeric>  
SENSe:IR:JUDGment[:RESistance]:LOWer?
```

Unit: OHM

Settings is reset to default when the *RST command is sent. (1 MOHM)

Response: NR3

Example

```
SENS:IR:JUDG:LOW 1000000
```

SENS:IR:JUDG:LOW:STAT

Sets whether to judge with the lower resistance limit in insulation resistance tests.
This setting is enabled when SENS:IR:JUDG:TYPE is set to RES.
Use SENS:IR:JUDG:LOW to set the lower limit.

Command

```
SENSe:IR:JUDGment[:RESistance]:LOWer:STATe <boolean>  
SENSe:IR:JUDGment[:RESistance]:LOWer:STATe?
```

Parameter

Value: ON(1) Judge (default)
OFF(0) Not judge

Settings is reset to default when the *RST command is sent.

Response: NR1

Example

```
SENS:IR:JUDG:LOW:STAT ON
```

SENSe:IR:JUDG:TYPE

Sets whether to use resistance or current to make upper limit judgment and lower limit judgment in insulation resistance tests.

Command

```
SENSe:IR:JUDGment:TYPE <character>
```

```
SENSe:IR:JUDGment:TYPE?
```

Parameter

Value: RESistance Judge using resistance (default)
 CURRent Judge using current

Settings is reset to default when the *RST command is sent.

Response: character

Example

```
SENS:IR:JUDG:TYPE RES
```

SENSe:IR:TERM:GRO

Sets whether to measure by including or excluding the current running through the stray capacitance in insulation resistance tests.

Command

```
SENSe:IR:TERMinal:GROund <character>
```

```
SENSe:IR:TERMinal:GROund?
```

Parameter

Value: LOW Measure including the current running through the stray capacitance (default)
 GUARd Measure excluding the current running through the stray capacitance

Settings is reset to default when the *RST command is sent.

Response: character

Example

```
SENS:IR:TERM:GRO GUAR
```

SENSe:MET Command

This is a subsystem for setting the meter mode (MET) test conditions.

SENS:MET:CURR:MODE

Sets the current measurement mode in meter mode.

Command

```
SENSe:METer:CURRent:MODE <character>
```

```
SENSe:METer:CURRent:MODE?
```

Parameter

Value:	ACDC	Measures the DC component and AC component with true rms values (default)
	AC	Measures only the AC component with true rms values
	DC	Measures only the DC component
	PEAK	Measures waveform peak values

Settings is reset to default when the *RST command is sent.

Response: character

Example

```
SENS:MET:CURR:MODE AC
```

SENSe:MET:NETW

Sets the measurement circuit network to use in meter mode.

Command

```
SENSe:METer:NETWork <character>
```

```
SENSe:METer:NETWork?
```

Parameter

Value:	A	IEC60990 Fig. 3 U1 measurement (default)
	B-U1	IEC60990 Fig. 4 U2 measurement
	B-U2	IEC60990 Fig. 4 U1 measurement
	C	IEC60990 Fig. 5 U3 measurement
	D	Electrical Appliances and Materials Safety Act single frequency
	E	Electrical Appliances and Materials Safety Act multiple frequencies
	F	IEC61029, UL
	G	IEC60745
	H	IEC61010-1, IEC61010-1 Wet condition
	I	IEC60601-1
	J	For calibration. Do not use.

Settings is reset to default when the *RST command is sent.

Response: character

Example

```
SENSe:MET:NETW A
```

SENS:MET:RANG

Sets the meter mode measurement range.

When set, auto range is turned off (SENS:MET:RANG:AUTO OFF).

Command

```
SENSe:METer[:VOLTage]:RANGe <numeric>
```

```
SENSe:METer[:VOLTage]:RANGe?
```

Parameter

Value: 42mV
420mV
4.2V
42V (default)

Unit: V

Settings is reset to default when the *RST command is sent.

Response: NR3

Example

```
SENS:MET:RANG 420MV
```

SENS:MET:RANG:AUTO

Sets whether to set the meter mode measurement range to auto.

If set to off, use SENS:MET:RANG to set the measurement range.

Command

```
SENSe:METer[:VOLTage]:RANGe:AUTO <boolean>
```

```
SENSe:METer[:VOLTage]:RANGe:AUTO?
```

Parameter

Value: ON(1) Switches the range automatically according to the measured values (default)
OFF(0) Fixed measurement range

Settings is reset to default when the *RST command is sent.

When you send the SENS:MET:RANG command, this setting is set to OFF.

Response: NR1

Example

```
SENS:MET:RANG:AUTO ON
```

SENS:MET:SELV

Sets the SELV voltage of meter mode.

This setting is enabled when SENS:MET:SELV:STAT is set to ON.

Command

```
SENSe:METer:SELVoltage <numeric>
```

```
SENSe:METer:SELVoltage?
```

Unit: V

Settings is reset to default when the *RST command is sent. (30 V)

Response: NR3

Example

```
SENS:MET:SELV 10
```

SENS:MET:SELV:STAT

Sets whether the SELV voltage is used.

Use SENS:MET:SELV to set the SELV voltage.

Command

```
SENSe:METer:SELVoltage:STATe <boolean>
```

```
SENSe:METer:SELVoltage:STATe?
```

Parameter

Value: ON(1) Set (default)
OFF(0) Not set

Settings is reset to default when the *RST command is sent.

Response: NR1

Example

```
SENS:MET:SELV:STAT ON
```

SENS:MET:TERM

Sets the touch mode of meter mode.

Command

```
SENSe:METer:TERMinal[:AB] <character>
```

```
SENSe:METer:TERMinal[:AB]?
```

Parameter

Value: NETWORK Measures the touch current across terminals A and B (default)
 VOLTmeter Measures the voltage across terminals A and B

Settings is reset to default when the *RST command is sent.

Response: character

Example

```
SENS:MET:TERM NETW
```

SENSe:PAT Command

This is a subsystem for setting the patient leakage current test (PAT) conditions.

SENS:PAT:BAND

Sets whether to expand the band of the internal voltmeter of this product in patient leakage current tests.

Command

```
SENSe:PATient[:VOLTage]:BANDwidth <character>
```

```
SENSe:PATient[:VOLTage]:BANDwidth?
```

Parameter

Value: NORMal Not expand (default)
 EXPand Expand

Settings is reset to default when the *RST command is sent.

Response: character

Example

```
SENS:PAT:BAND NORM
```

SENSe:PAT:COND

Sets the single fault condition for patient leakage current tests.

Use SENSe:PAT:COND:FAUL to set the disconnected condition.

Command

```
SENSe:PATient:CONDition <character>
```

```
SENSe:PATient:CONDition?
```

Parameter

Value:	NORMal	Normal condition (default)
	FAULt	Disconnected condition

Settings is reset to default when the *RST command is sent.

Response: character

Example

```
SENS:PAT:COND NORM
```

SENSe:PAT:COND:FAUL

Sets the disconnected condition at fault for patient leakage current tests.

Use SENSe:PAT:COND to set the fault condition.

Command

```
SENSe:PATient:CONDition:FAULt <character>
```

```
SENSe:PATient:CONDition:FAULt?
```

Parameter

Value:	NEUTral	Disconnected power supply line (neutral) (default)
	PEARth	Disconnected earth line

Settings is reset to default when the *RST command is sent.

Response: character

Example

```
SENS:PAT:COND:FAUL NEUT
```

SENS:PAT:CURR:MODE

Sets the current measurement mode in patient leakage current tests.

Command

```
SENSe:PATient:CURRent:MODE <character>
```

```
SENSe:PATient:CURRent:MODE?
```

Parameter

Value:	ACDC	Measures the DC component and AC component with true rms values (default)
	AC	Measures only the AC component with true rms values
	DC	Measures only the DC component
	PEAK	Measures waveform peak values

Settings is reset to default when the *RST command is sent.

Response: character

Example

```
SENS:PAT:CURR:MODE AC
```

SENS:PAT:JUDG

Sets the reference current for upper limit judgment in patient leakage current tests.

This setting is enabled when SENS:PAT:JUDG:STAT is set to ON.

Command

```
SENSe:PATient:JUDGment[:CURRent][:UPPer] <numeric>
```

```
SENSe:PATient:JUDGment[:CURRent][:UPPer] ?
```

Unit: A

Settings is reset to default when the *RST command is sent. (100 UA)

Response: NR3

Example

```
SENS:PAT:JUDG 10UA
```

SENS:PAT:JUDG:STAT

Sets whether to judge with the upper current limit in patient leakage current tests.

Use SENS:PAT:JUDG to set the upper limit.

Command

```
SENSe:PATient:JUDGment[:CURRent][:UPPer]:STATe <boolean>
```

```
SENSe:PATient:JUDGment[:CURRent][:UPPer]:STATe?
```

Parameter

Value: ON(1) Judge (default)

OFF(0) Not judge

Settings is reset to default when the *RST command is sent.

Response: NR1

Example

```
SENS:PAT:JUDG:STAT ON
```

SENS:PAT:JUDG:DEL

Set the time until starting judgments in patient leakage current tests.

This setting is enabled when SENS:PAT:JUDG:DEL:STAT is set to ON.

Command

```
SENSe:PATient:JUDGment:DELay <numeric>
```

```
SENSe:PATient:JUDGment:DELay?
```

Unit: S

Settings is reset to default when the *RST command is sent. (1 S)

Response: NR3

Example

```
SENS:PAT:JUDG:DEL 5S
```

SENS:PAT:JUDG:DEL:STAT

Sets whether to set the judgment delay in patient leakage current tests.

Use SENS:PAT:JUDG:DEL to set the judgment delay.

Command

```
SENSe:PATient:JUDGment:DELay:STATe <boolean>
```

```
SENSe:PATient:JUDGment:DELay:STATe?
```

Parameter

Value: ON(1) Set
OFF(0) Not set (default)

Settings is reset to default when the *RST command is sent.

Response: NR1

Example

```
SENS:PAT:JUDG:DEL:STAT ON
```

SENSe:PAT:JUDG:LOW

Sets the reference current for lower limit judgment in patient leakage current tests.

This setting is enabled when SENSe:PAT:JUDG:LOW:STAT is set to ON.

Command

```
SENSe:PATient:JUDGment[:CURRent]:LOWer <numeric>
```

```
SENSe:PATient:JUDGment[:CURRent]:LOWer?
```

Unit: A

Settings is reset to default when the *RST command is sent. (0.01 MA)

Response: NR3

Example

```
SENSe:PAT:JUDG:LOW 10UA
```

SENSe:PAT:JUDG:LOW:STAT

Sets whether to judge with the lower current limit in patient leakage current tests.

Use SENSe:PAT:JUDG:LOW to set the lower limit.

Command

```
SENSe:PATient:JUDGment[:CURRent]:LOWer:STATe <boolean>
```

```
SENSe:PATient:JUDGment[:CURRent]:LOWer:STATe?
```

Parameter

Value: ON(1) Judge
OFF(0) Not judge (default)

Settings is reset to default when the *RST command is sent.

Response: NR1

Example

```
SENSe:PAT:JUDG:LOW:STAT ON
```

SENS:PAT:NETW

Sets the measurement circuit network that is compatible with the patient leakage current test standard.

The only network that can be used for patient leakage current tests is I (for IEC60601-1).

Command

```
SENSe:PATient:NETWork <character>
```

```
SENSe:PATient:NETWork?
```

Parameter

Value: I For IEC60601-1

Response: character

Example

```
SENS:PAT:NETW I
```

SENSe: PAT: NETW: PROB

Sets the B terminal probe connection destination for patient leakage current tests.

The A terminal probe connection destination is a part applied to the patient.

Command

```
SENSe: PATient: NETWork: PROBe[:B] <character>
```

```
SENSe: PATient: NETWork: PROBe[:B]?
```

Parameter

Value:	PEARth	Measures the patient leakage current or the total patient leakage current across a part applied to the patient and earth. (default)
	T110pct	Measures the patient leakage current running across the F-type applied part and 110% terminal.
	PATient	Measures the patient measurement current across parts applied to the patient.

Settings is reset to default when the *RST command is sent.

Response: character

Example

```
SENSe: PAT: NETW: PROB PEAR
```

SENS:PAT:NETW:PROB:A

Queries the A terminal probe connection destination in patient leakage current tests.

Command

```
SENSe:PATient:NETWork:PROBe:A?
```

Response: character

Returns "PAT" (a part applied to the patient).

SENS:PAT:RANG:AUTO

Sets the measurement range for patient leakage current tests.

Command

```
SENSe:PATient[:VOLTage]:RANGe:AUTO <boolean>
```

```
SENSe:PATient[:VOLTage]:RANGe:AUTO?
```

Parameter

Value: ON(1) Switches the range automatically according to the measured values (default)
OFF(0) The measurement range is fixed Range 1 to 4 according to the Upper, and Measure Mode settings.

Settings is reset to default when the *RST command is sent.

Response: NR1

Example

```
SENS:PAT:RANG:AUTO ON
```

SENSe:PAT:TIM

Sets the test time for patient leakage current tests.

This setting is enabled when SENS:PAT:TIM:STAT is set to ON.

Command

```
SENSe:PATient:TIMer <numeric>
```

```
SENSe:PATient:TIMer?
```

Unit: S

Settings is reset to default when the *RST command is sent. (1 S)

Response: NR3

Example

```
SENS:PAT:TIM 10S
```

SENSe:PAT:TIM:STAT

Sets whether to set the test time in patient leakage current tests.

Use SENS:PAT:TIM to set the test time.

Command

```
SENSe:PATient:TIMer:STATe <boolean>
```

```
SENSe:PATient:TIMer:STATe?
```

Parameter

Value:	ON(1)	Set (default)
	OFF(0)	Not set

Settings is reset to default when the *RST command is sent.

If the offset setting is set to ON (CALC:SCAL:OFFS:AUTO ON), the SENS:PAT:TIM:STAT setting turns OFF when a test is performed.

Response: NR1

Example

```
SENS:PAT:TIM:STAT ON
```

SENSe:PCC Command

This is a subsystem for setting the protective conductor current test (PCC) conditions.

SENS:PCC:BAND

Sets whether to expand the band of the internal voltmeter of this product in protective conductor current tests.

Command

```
SENSe:PCCurrent[:VOLTage]:BANDwidth <character>
```

```
SENSe:PCCurrent[:VOLTage]:BANDwidth?
```

Parameter

Value:	NORMal	Not expand (default)
	EXPand	Expand

Settings is reset to default when the *RST command is sent.

Response: character

Example

```
SENS:PCC:BAND NORM
```

SENSe:PCC:COND

Sets the single fault mode for protective conductor current tests.

Command

```
SENSe:PCCurrent:CONDition <character>
```

```
SENSe:PCCurrent:CONDition?
```

Parameter

Value: NORMAL Normal condition (default)
 FAULt Disconnected power supply line (neutral)

Settings is reset to default when the *RST command is sent.

Response: character

Example

```
SENSe:PCC:COND FAUL
```

SENS:PCC:COND:FAUL

Queries the disconnected condition at fault for protective conductor current tests.

Command

```
SENSe:PCCurrent:CONDition:FAULt?
```

Response: character

Returns "NEUT" (disconnected condition of the power supply line (neutral)).

SENS:PCC:CURR:MODE

Sets the current measurement mode in protective conductor current tests.

Command

```
SENSe:PCCurrent:CURRent:MODE <character>
```

```
SENSe:PCCurrent:CURRent:MODE?
```

Parameter

Value:	ACDC	Measures the DC component and AC component with true rms values (default)
	AC	Measures only the AC component with true rms values
	DC	Measures only the DC component
	PEAK	Measures waveform peak values

Settings is reset to default when the *RST command is sent.

Response: character

Example

```
SENS:PCC:CURR:MODE AC
```

SENSe:PCC:JUDG

Sets the reference current for upper limit judgment in protective conductor current tests.

This setting is enabled when SENSe:PCC:JUDG:STAT is set to ON.

Command

```
SENSe:PCCurrent:JUDGment[:CURRent][:UPPer] <numeric>
SENSe:PCCurrent:JUDGment[:CURRent][:UPPer]?
```

Unit: A

Settings is reset to default when the *RST command is sent. (100 UA)

Response: NR3

Example

```
SENSe:PCC:JUDG 10UA
```

SENSe:PCC:JUDG:STAT

Sets whether to judge with the upper current limit in protective conductor current tests.

Use SENSe:PCC:JUDG to set the upper limit.

Command

```
SENSe:PCCurrent:JUDGment[:CURRent][:UPPer]:STATe <boolean>
SENSe:PCCurrent:JUDGment[:CURRent][:UPPer]:STATe?
```

Parameter

Value: ON(1) Judge (default)
OFF(0) Not judge

Settings is reset to default when the *RST command is sent.

Response: NR1

Example

```
SENSe:PCC:JUDG:STAT ON
```

SENS:PCC:JUDG:DEL

Sets the time until starting judgments in protective conductor current tests.

This setting is enabled when SENS:PCC:JUDG:DEL:STAT is set to ON.

Command

```
SENSe:PCCurrent:JUDGment:DELaY <numeric>
```

```
SENSe:PCCurrent:JUDGment:DELaY?
```

Unit: S

Settings is reset to default when the *RST command is sent. (1 S)

Response: NR3

Example

```
SENS:PCC:JUDG:DEL 5S
```

SENS:PCC:JUDG:DEL:STAT

Sets whether to set the judgment delay in protective conductor current tests.

Use SENS:PCC:JUDG:DEL to set the judgment delay.

Command

```
SENSe:PCCurrent:JUDGment:DELaY:STATe <boolean>
```

```
SENSe:PCCurrent:JUDGment:DELaY:STATe?
```

Parameter

Value: ON(1) Set
OFF(0) Not set (default)

Settings is reset to default when the *RST command is sent.

Response: NR1

Example

```
SENS:PCC:JUDG:DEL:STAT ON
```

SENSe:PCC:JUDG:LOW

Sets the reference current for lower limit judgment in protective conductor current tests.

This setting is enabled when SENSe:PCC:JUDG:LOW:STAT is set to ON.

Command

```
SENSe:PCCurrent:JUDGment[:CURRent]:LOWer <numeric>
```

```
SENSe:PCCurrent:JUDGment[:CURRent]:LOWer?
```

Unit: A

Settings is reset to default when the *RST command is sent. (0.01 MA)

Response: NR3

Example

```
SENSe:PCC:JUDG:LOW 10UA
```

SENSe:PCC:JUDG:LOW:STAT

Sets whether to judge with the lower current limit in protective conductor current tests.

Use SENSe:PCC:JUDG:LOW to set the lower limit.

Command

```
SENSe:PCCurrent:JUDGment[:CURRent]:LOWer:STATe <boolean>
```

```
SENSe:PCCurrent:JUDGment[:CURRent]:LOWer:STATe?
```

Parameter

Value: ON(1) Judge
OFF(0) Not judge (default)

Settings is reset to default when the *RST command is sent.

Response: NR1

Example

```
SENSe:PCC:JUDG:LOW:STAT ON
```

SENS:PCC:NETW

Sets the measurement circuit network to use in protective conductor current tests.

Command

```
SENSe:PCCurrent:NETWork <character>
```

```
SENSe:PCCurrent:NETWork?
```

Parameter

Value:	I	Ground leakage current measurement of medical instruments
	PCC-1	Protective conductor current measurement (default)
	PCC-2	IEC60598-1

Settings is reset to default when the *RST command is sent.

Response: character

Example

```
SENS:PCC:NETW I
```

SENS:PCC:RANG:AUTO

Sets the measurement range for protective conductor current tests.

Command

```
SENSe:PCCurrent[:VOLTage]:RANGe:AUTO <boolean>
```

```
SENSe:PCCurrent[:VOLTage]:RANGe:AUTO?
```

Parameter

Value:	ON(1)	Switches the range automatically according to the measured values (default)
	OFF(0)	The measurement range is fixed Range 1 to 4 according to the Network, Upper, and Measure Mode settings.

Settings is reset to default when the *RST command is sent.

Response: NR1

Example

```
SENS:PCC:RANG:AUTO ON
```

SENSe:PCC:TIM

Sets the test time for protective conductor current tests.

This setting is enabled when SENS:PCC:TIM:STAT is set to ON.

Command

```
SENSe:PCCurrent:TIMer <numeric>
```

```
SENSe:PCCurrent:TIMer?
```

Unit: S

Settings is reset to default when the *RST command is sent. (1 S)

Response: NR3

Example

```
SENS:PCC:TIM 10S
```

SENSe:PCC:TIM:STAT

Sets whether to set the test time in protective conductor current tests.

Use SENS:PCC:TIM to set the test time.

Command

```
SENSe:PCCurrent:TIMer:STATe <boolean>
```

```
SENSe:PCCurrent:TIMer:STATe?
```

Parameter

Value: ON(1) Set (default)
OFF(0) Not set

Settings is reset to default when the *RST command is sent.

If the offset setting is set to ON (CALC:SCAL:OFFS:AUTO ON), the SENS:PC-C:TIM:STAT setting turns OFF when a test is performed.

Response: NR1

Example

```
SENS:PCC:TIM:STAT ON
```

SENSe:PD command

This is a subsystem for setting the partial discharge (PD) conditions.

SENS:PD:FILT:BPAS

Sets the bandwidth for partial discharge tests.

Command

```
SENSe:PD[:COULomb]:FILTer:BPASs <numeric>
```

```
SENSe:PD[:COULomb]:FILTer:BPASs?
```

Parameter

Value: 100KHZ、160KHZ、300KHZ

Unit: HZ

Settings is reset to default when the *RST command is sent. (160KHZ)

Response: NR3

Example

```
SENS:PD:FILT:BPAS 160KHZ
```

SENS:PD:FILT:LPAS:STAT

Sets the low-pass filter for partial discharge tests.

Command

```
SENSe:PD[:COULomb]:FILTer:LPASs:STATe <boolean>
```

```
SENSe:PD[:COULomb]:FILTer:LsPASs:STATe?
```

Parameter

Value: ON(1) On (default)
 OFF(0) Off

Settings is reset to default when the *RST command is sent.

Response: NR1

Example

```
SENS:PD:FILT:LPAS:STAT ON
```

SENS:PD:JUDG

Sets the reference discharge electric charge for upper limit judgment in partial discharge tests.

This setting is enabled when SENS:PD:JUDG:STAT is set to ON.

Command

```
SENSe:PD:JUDGment[:COULomb][:UPPer] <numeric>
```

```
SENSe:PD:JUDGment[:COULomb][:UPPer]?
```

Unit: C

Settings is reset to default when the *RST command is sent. (1000PC)

Response: NR3

Example

```
SENS:PD:JUDG 20PC
```

SENS:PD:JUDG:STAT

Sets whether to judge with the upper limit of discharge electric charge in partial discharge tests.

Use SENS:PD:JUDG to set the upper limit.

Command

```
SENSe:PD:JUDGment[:COULomb][:UPPer]:STATe <boolean>
```

```
SENSe:PD:JUDGment[:COULomb][:UPPer]:STATe?
```

Parameter

Value: ON(1) Judge (default)
OFF(0) Judge

Settings is reset to default when the *RST command is sent.

Response: NR1

Example

```
SENS:PD:JUDG:STAT OFF
```

SENSe:PD:JUDG:PCO

Sets the upper limit number of times the electric charge exceeds its threshold in partial discharge tests.

This setting is enabled when SENSe:PD:JUDG:PCO:STAT is set to ON.

Command

```
SENSe:PD:JUDGment:PCOunt[:UPPer] <numeric>
```

```
SENSe:PD:JUDGment:PCOunt[:UPPer]?
```

Unit: A

Settings is reset to default when the *RST command is sent. (1)

Response: NR3

Example

```
SENSe:PD:JUDG:PCO 20
```

SENSe:PD:JUDG:PCO:STAT

Sets whether to judge based on the upper limit number of times the electric charge exceeds its threshold in partial discharge tests.

Use SENSe:PD:JUDG:PCO to set the upper limit.

Command

```
SENSe:PD:JUDGment:PCOunt[:UPPer]:STATe <boolean>
```

```
SENSe:PD:JUDGment:PCOunt[:UPPer]:STATe?
```

Parameter

Value: ON(1) Judge (default)
OFF(0) Not judge

Settings is reset to default when the *RST command is sent.

Response: NR1

Example

```
SENSe:PD:JUDG:PCO:STAT OFF
```

SENS:PD:PCO:THR

Sets the electric charge threshold for partial discharge tests.

Command

```
SENSe:PD:PCOunt:THReshold[:LEVel] <numeric>
```

```
SENSe:PD:PCOunt:THReshold[:LEVel]?
```

Unit: PCT

Settings is reset to default when the *RST command is sent. (25PCT)

Response: NR3

Example

```
SENS:PD:PCO:THR 30PCT
```

SENS:PD:RANG

Sets the measurement range in partial discharge tests.

Command

```
SENSe:PD[:COULomb]:RANGe <numeric>
```

```
SENSe:PD[:COULomb]:RANGe?
```

Parameter

Value: 100PC, 1000PC, 10000PC

Unit: C

Settings is reset to default when the *RST command is sent. (10000PC)

Response: NR3

Example

```
SENS:PD:RANG 10000PC
```

SENSe:PD:VOLT:MODE

Sets the voltage measurement mode in partial discharge tests.

Command

```
SENSe:PD:VOLTage:MODE <character>
```

```
SENSe:PD:VOLTage:MODE?
```

Parameter

Value:	RMS	Measurement with a true rms value (default)
	PEAK	Measurement with a peak value

Settings is reset to default when the *RST command is sent.

Response: character

Example

```
SENSe:PD:VOLT:MODE PEAK
```

SENSe:TC Command

This is a subsystem for setting the touch current test (TC) conditions.

SENSe:TC:BAND

Sets whether to expand the band of the internal voltmeter of this product in touch current tests.

Command

```
SENSe:TC[:VOLTage]:BANDwidth <character>
```

```
SENSe:TC[:VOLTage]:BANDwidth?
```

Parameter

Value: NORMal Not expand (default)
 EXPand Expand

Settings is reset to default when the *RST command is sent.

Response: character

Example

```
SENSe:TC:BAND NORM
```

SENSe:TC:COND

Sets the single fault condition for touch current tests.

Use SENSe:TC:COND:FAULt to set the disconnected condition.

Command

```
SENSe:TC:CONDition <character>
```

```
SENSe:TC:CONDition?
```

Parameter

Value:	NORMal	Normal condition (default)
	FAULt	Disconnected condition

Settings is reset to default when the *RST command is sent.

Response: character

Example

```
SENSe:TC:COND NORM
```

SENSe:TC:COND:FAUL

Sets the disconnected condition at fault for touch current tests.

Use SENSe:TC:COND to set the fault condition.

Command

```
SENSe:TC:CONDition:FAULt <character>
```

```
SENSe:TC:CONDition:FAULt?
```

Parameter

Value:	NEUTral	Disconnected power supply line (neutral) (default)
	PEARth	Disconnected protective ground wire condition.

Settings is reset to default when the *RST command is sent.

Response: character

Example

```
SENSe:TC:COND:FAUL NEUT
```

SENS:TC:CURR:MODE

Sets the current measurement mode in touch current tests.

Command

```
SENSe:TC:CURRent:MODE <character>
```

```
SENSe:TC:CURRent:MODE?
```

Parameter

Value:	ACDC	Measures the DC component and AC component with true rms values (default)
	AC	Measures only the AC component with true rms values
	DC	Measures only the DC component
	PEAK	Measures waveform peak values

Settings is reset to default when the *RST command is sent.

Response: character

Example

```
SENS:TC:CURR:MODE AC
```

SENSe:TC:JUDG

Sets the reference current for upper limit judgment in touch current tests.

This setting is enabled when SENSe:TC:JUDG:STAT is set to ON.

Command

```
SENSe:TC:JUDGment[:CURRent][:UPPer] <numeric>
```

```
SENSe:TC:JUDGment[:CURRent][:UPPer]?
```

Unit: A

Settings is reset to default when the *RST command is sent. (100 UA)

Response: NR3

Example

```
SENSe:TC:JUDG 10UA
```

SENSe:TC:JUDG:STAT

Sets whether to judge with the upper current limit in touch current tests.

Use SENSe:TC:JUDG to set the upper limit.

Command

```
SENSe:TC:JUDGment[:CURRent][:UPPer]:STATe <boolean>
```

```
SENSe:TC:JUDGment[:CURRent][:UPPer]:STATe?
```

Parameter

Value: ON(1) Judge (default)

OFF(0) Not judge

Settings is reset to default when the *RST command is sent.

Response: NR1

Example

```
SENSe:TC:JUDG:STAT ON
```

SENS:TC:JUDG:DEL

Set the time until starting judgments in touch current tests.

This setting is enabled when SENS:TC:JUDG:DEL:STAT is set to ON.

Command

```
SENSe:TC:JUDGment:DELaY <numeric>
```

```
SENSe:TC:JUDGment:DELaY?
```

Unit: S

Settings is reset to default when the *RST command is sent. (1 S)

Response: NR3

Example

```
SENS:TC:JUDG:DEL 5S
```

SENS:TC:JUDG:DEL:STAT

Sets whether to set the judgment delay in touch current tests.

Use SENS:TC:JUDG:DEL to set the judgment delay.

Command

```
SENSe:TC:JUDGment:DELaY:STATe <boolean>
```

```
SENSe:TC:JUDGment:DELaY:STATe?
```

Parameter

Value: ON(1) Set
OFF(0) Not set (default)

Settings is reset to default when the *RST command is sent.

Response: NR1

Example

```
SENS:TC:JUDG:DEL:STAT ON
```

SENSe:TC:JUDG:LOW

Sets the reference current for lower limit judgment in touch current tests.
This setting is enabled when SENSe:TC:JUDG:LOW:STAT is set to ON.

Command

```
SENSe:TC:JUDGment[:CURRent]:LOWer <numeric>
SENSe:TC:JUDGment[:CURRent]:LOWer?
```

Unit: A

Settings is reset to default when the *RST command is sent. (0.01 MA)

Response: NR3

Example

```
SENSe:TC:JUDG:LOW 10UA
```

SENSe:TC:JUDG:LOW:STAT

Sets whether to judge with the lower current limit in touch current tests.
Use SENSe:TC:JUDG:LOW to set the lower limit.

Command

```
SENSe:TC:JUDGment[:CURRent]:LOWer:STATe <boolean>
SENSe:TC:JUDGment[:CURRent]:LOWer:STATe?
```

Parameter

Value: ON(1) Judge
OFF(0) Not judge (default)

Settings is reset to default when the *RST command is sent.

Response: NR1

Example

```
SENSe:TC:JUDG:LOW:STAT ON
```

SENS:TC:NETW

Sets the measurement circuit network to use in touch current tests.

Command

```
SENSe:TC:NETWork <character>
```

```
SENSe:TC:NETWork?
```

Parameter

Value:	A	IEC60990 Fig. 3 U1 measurement (default)
	B-U1	IEC60990 Fig. 4 U2 measurement
	B-U2	IEC60990 Fig. 4 U1 measurement
	C	IEC60990 Fig. 5 U3 measurement
	D	Electrical Appliances and Materials Safety Act single frequency
	E	Electrical Appliances and Materials Safety Act multiple frequencies
	F	IEC61029, UL
	G	IEC60745
	H	IEC61010-1, IEC61010-1 Wet condition
	I	IEC60601-1
	J	For calibration. Do not use.

Settings is reset to default when the *RST command is sent.

Response: character

Example

```
SENS:TC:NETW A
```

SENSe:TC:NETW:PROB

Sets the B terminal probe connection destination for touch current tests.

The A terminal probe connection destination is the enclosure.

Command

```
SENSe:TC:NETWork:PROBe[:B] <character>
```

```
SENSe:TC:NETWork:PROBe[:B]?
```

Parameter

Value:	PEARth	Measures across the enclosure and earth. (default)
	ENCLosure	Measures across two points on the enclosure.
	LIVe	Measures across the enclosure and power supply line (live).
	NEUTral	Measures across the enclosure and power supply line (neutral).

Settings is reset to default when the *RST command is sent.

Response: character

Example

```
SENSe:TC:NETW:PROB PEAR
```

SENSe:TC:NETW:PROB:A

Queries the A terminal probe connection destination in touch current tests.

Command

```
SENSe:TC:NETWork:PROBe:A?
```

Response: character

ENCL (enclosure) is returned.

SENS:TC:RANG:AUTO

Sets the measurement range for touch current tests.

Command

```
SENSe:TC[:VOLTage]:RANGe:AUTO <boolean>
```

```
SENSe:TC[:VOLTage]:RANGe:AUTO?
```

Parameter

Value: ON(1) Switches the range automatically according to the measured values (default)
OFF(0) The measurement range is fixed Range 1 to 4 according to the Network, Upper, and Measure Mode settings.

Settings is reset to default when the *RST command is sent.

Response: NR1

Example

```
SENS:TC:RANG:AUTO ON
```

SENSe:TC:TIM

Sets the test time for touch current tests.

This setting is enabled when SENSe:TC:TIM:STAT is set to ON.

Command

```
SENSe:TC:TIMer <numeric>
```

```
SENSe:TC:TIMer?
```

Unit: S

Settings is reset to default when the *RST command is sent. (1 S)

Response: NR3

Example

```
SENSe:TC:TIM 10S
```

SENSe:TC:TIM:STAT

Sets whether to set the test time in touch current tests.

Use SENSe:TC:TIM to set the test time.

Command

```
SENSe:TC:TIMer:STATe <boolean>
```

```
SENSe:TC:TIMer:STATe?
```

Parameter

Value: ON(1) Set (default)
OFF(0) Not set

Settings is reset to default when the *RST command is sent.

Response: NR1

Example

```
SENSe:TC:TIM:STAT ON
```

[SOURce:] command

FUNC

Set the test mode.

You can only set the test mode to one of the test modes that is available on your model.

Command

```
[SOURce:]FUNctIon[:MODE] <character>
```

```
[SOURce:]FUNctIon[:MODE]?
```

Parameter

Value:	ACW	AC withstanding voltage (default)
	DCW	DC withstanding voltage
	IR	Insulation resistance
	ECac	Earth continuity (AC)
	ECDC	Earth continuity (DC)
	TC	Touch current
	PCC	Protective conductor current
	METer	Meter mode
	PATient	Patient leakage current
	PD	Partial discharge
	PROGram	Auto test

Settings is reset to default when the *RST command is sent.

Response: character

Example

```
FUNC ACW
```

[SOURce:]ACW Command

The ACW in the second node can be omitted, but to distinguish it from the DC withstanding voltage test, we recommend that you do not.

ACW:VOLT

Sets the test voltage for AC withstanding voltage tests.

Command

```
[SOURce:][ACW:]VOLTage[:LEVel][:IMMediate][:AMPlitude] <numeric>
```

```
[SOURce:][ACW:]VOLTage[:LEVel][:IMMediate][:AMPlitude]?
```

Unit: V

Settings is reset to default when the *RST command is sent. (0 V)

Response: NR3

Example

```
ACW:VOLT 1000V
```

ACW:VOLT:END:STAT

Sets the terminating voltage for AC withstanding voltage tests.

This is valid when the voltage fall time (ACW:VOLT:SWE:FALL:TIM:STAT ON) is enabled.

Command

```
[SOURce][:ACW]:VOLTage:END:STATe <boolean>
```

```
[SOURce][:ACW]:VOLTage:END:STATe?
```

Parameter

Value: ON(1) On
OFF(0) Off (default)

Settings is reset to default when the *RST command is sent.

Response: NR1

Example

```
ACW:VOLT:END:STAT ON
```

ACW:VOLT:FREQ

Sets the test voltage frequency for AC withstanding voltage tests.

Command

```
[SOURCE:][ACW:]VOLTage:FREQuency <numeric>
```

```
[SOURCE:][ACW:]VOLTage:FREQuency?
```

Unit: Hz

Settings is reset to default when the *RST command is sent. (50 HZ)

Response: NR3

Example

```
ACW:VOLT:FREQ 50HZ
```

ACW:VOLT:PROT

Sets the limit voltage for AC withstanding voltage tests.

Command

```
[SOURCE:][ACW:]VOLTage:PROTection[:LEVel][:UPPer] <numeric>
```

```
[SOURCE:][ACW:]VOLTage:PROTection[:LEVel][:UPPer]?
```

Unit: V

Settings is reset to default when the *RST command is sent. (5500 V)

Response: NR3

Example

```
ACW:VOLT:PROT 1.5KV
```

ACW:VOLT:STAR

Sets the start voltage as a percentage for AC withstanding voltage tests.

This setting is enabled when VOLT:STAR:STAT is set to ON.

Command

```
[SOURCE:][ACW:]VOLTage:STARt[:LEVel] <numeric>
```

```
[SOURCE:][ACW:]VOLTage:STARt[:LEVel]?
```

Unit: PCT

Settings is reset to default when the *RST command is sent. (50 PCT)

Response: NR3

Example

```
ACW:VOLT:STAR 50PCT
```

ACW:VOLT:STAR:STAT

Sets whether to set the start voltage for AC withstanding voltage tests.

Use VOLT:STAR to set the start voltage.

Command

```
[SOURCE:][ACW:]VOLTage:STARt:STATe <boolean>
```

```
[SOURCE:][ACW:]VOLTage:STARt:STATe?
```

Parameter

Value: ON(1) Set
OFF(0) Not set (default)

Settings is reset to default when the *RST command is sent.

Response: NR1

Example

```
ACW:VOLT:STAR:STAT ON
```

ACW:VOLT:SWE:FALL:TIM

Sets the voltage fall time for AC withstanding voltage tests.

This setting is enabled when VOLT:SWE:FALL:TIM:STAT is set to ON.

Command

```
[SOURCE:] [ACW:] VOLTage:SWEep:FALL:TIMer <numeric>
```

```
[SOURCE:] [ACW:] VOLTage:SWEep:FALL:TIMer?
```

Unit: S

Settings is reset to default when the *RST command is sent. (0.1 S)

Response: NR3

Example

```
ACW:VOLT:SWE:FALL:TIM 0.1S
```

ACW:VOLT:SWE:FALL:TIM:STAT

Sets whether to set the voltage fall time for AC withstanding voltage tests.

Use VOLT:SWE:FALL:TIM to set the voltage fall time.

Command

```
[SOURCE:] [ACW:] VOLTage:SWEep:FALL:TIMer:STATe <boolean>
```

```
[SOURCE:] [ACW:] VOLTage:SWEep:FALL:TIMer:STATe?
```

Parameter

Value: ON(1) Set
OFF(0) Not set (default)

Settings is reset to default when the *RST command is sent.

Response: NR1

Example

```
ACW:VOLT:SWE:FALL:TIM:STAT ON
```

ACW:VOLT:SWE:TIM

Sets the voltage rise time for AC withstanding voltage tests.

Command

```
[SOURce:][ACW:]VOLTage:SWEep[:RISE]:TIMer <numeric>
```

```
[SOURce:][ACW:]VOLTage:SWEep[:RISE]:TIMer?
```

Unit: S

Settings is reset to default when the *RST command is sent. (0.1 S)

Response: NR3

Example

```
ACW:VOLT:SWE:TIM 1S
```

ACW:VOLT:TIM

Sets the test time for AC withstanding voltage tests.

This setting is enabled when VOLT:TIM:STAT is set to ON.

Command

```
[SOURCE:][ACW:]VOLTage:TIMer <numeric>
```

```
[SOURCE:][ACW:]VOLTage:TIMer?
```

Unit: S

Settings is reset to default when the *RST command is sent. (0.2 S)

Response: NR3

Example

```
ACW:VOLT:TIM 60S
```

ACW:VOLT:TIM:STAT

Sets whether to set the test time for AC withstanding voltage tests.

Use VOLT:TIM to set the test time.

Command

```
[SOURCE:][ACW:]VOLTage:TIMer:STATe <boolean>
```

```
[SOURCE:][ACW:]VOLTage:TIMer:STATe?
```

Parameter

Value:	ON(1)	Set (default)
	OFF(0)	Not set

Settings is reset to default when the *RST command is sent.

If the offset setting is set to ON (CALC:SCAL:OFFS:AUTO ON), the ACW:-VOLT:TIM:STAT setting turns OFF when a test is performed.

Response: NR1

Example

```
ACW:VOLT:TIM:STAT ON
```

[SOURce:]DCW Command

DCW:VOLT

Sets the test voltage for DC withstanding voltage tests.

Command

```
[SOURce:]DCW:VOLTage[:LEVel][:IMMediate][:AMPlitude] <numeric>  
[SOURce:]DCW:VOLTage[:LEVel][:IMMediate][:AMPlitude]?
```

Unit: V

Settings is reset to default when the *RST command is sent. (0 V)

Response: NR3

Example

```
DCW:VOLT 750V
```

DCW:VOLT:DISC:INT:STAT

Sets whether to discharge when interlock is activated in DC withstanding voltage tests.

Command

```
[SOURce:]DCW:VOLTage:DISCharge:INTerlock:STATe <boolean>  
[SOURce:]DCW:VOLTage:DISCharge:INTerlock:STATe?
```

Parameter

Value: ON(1) Discharge (default)
OFF(0) Not discharge

Settings is reset to default when the *RST command is sent.

Response: NR1

Example

```
DCW:VOLT:DISC:INT:STAT ON
```

DCW:VOLT:DISC:TIM

Sets the discharge time for DC withstanding voltage tests.

Command

```
[SOURCE:]DCW:VOLTage:DISCharge:TIMer[:MINimum] <numeric>
```

```
[SOURCE:]DCW:VOLTage:DISCharge:TIMer[:MINimum]?
```

Unit: S

Settings is reset to default when the *RST command is sent. (0 S)

Response: NR3

Example

```
DCW:VOLT:DISC:TIM 10S
```

DCW:VOLT:END:STAT

Sets the terminating voltage for DC withstanding voltage tests.

This is valid when the voltage fall time (DCW:VOLT:SWE:FALL:TIM:STAT ON) is enabled.

Command

```
[SOURCE:]DCW:VOLTage:END:STATe <boolean>
```

```
[SOURCE:]DCW:VOLTage:END:STATe?
```

Parameter

Value: ON(1) On
OFF(0) Off (default)

Settings is reset to default when the *RST command is sent.

Response: NR1

Example

```
DCW:VOLT:END:STAT ON
```

DCW:VOLT:PROT

Sets the limit voltage for DC withstanding voltage tests.

Command

```
[SOURce:]DCW:VOLTage:PROTection[:LEVel][:UPPer] <numeric>
```

```
[SOURce:]DCW:VOLTage:PROTection[:LEVel][:UPPer]?
```

Unit: V

Settings is reset to default when the *RST command is sent. (7500 V)

Response: NR3

Example

```
DCW:VOLT:PROT 1500V
```

DCW:VOLT:STAR

Sets the start voltage as a percentage for DC withstanding voltage tests.

This setting is enabled when DCW:VOLT:STAR:STAT is set to ON.

```
[SOURCE:]DCW:VOLTage:STARt[:LEVel] <numeric>
```

```
[SOURCE:]DCW:VOLTage:STARt[:LEVel]?
```

Unit: PCT

Settings is reset to default when the *RST command is sent. (50 PCT)

Response: NR3

Example

```
DCW:VOLT:STAR 50PCT
```

DCW:VOLT:STAR:STAT

Sets whether to set the start voltage for DC withstanding voltage tests.

Use DCW:VOLT:STAR to set the start voltage.

Command

```
[SOURCE:]DCW:VOLTage:STARt:STATe <boolean>
```

```
[SOURCE:]DCW:VOLTage:STARt:STATe?
```

Parameter

Value: ON(1) Set
OFF(0) Not set (default)

Settings is reset to default when the *RST command is sent.

Response: NR1

Example

```
DCW:VOLT:STAR:STAT ON
```

DCW:VOLT:SWE:FALL:TIM

Sets the voltage fall time for DC withstanding voltage tests.

This setting is enabled when DCW:VOLT:SWE:FALL:STAT is set to ON.

Command

```
[SOURCE:]DCW:VOLTage:SWEep:FALL:TIMer <numeric>
```

```
[SOURCE:]DCW:VOLTage:SWEep:FALL:TIMer?
```

Unit: S

Settings is reset to default when the *RST command is sent. (0.1 S)

Response: NR3

Example

```
DCW:VOLT:SWE:FALL:TIM 0.1S
```

DCW:VOLT:SWE:FALL:TIM:STAT

Sets whether to set the voltage fall time for DC withstanding voltage tests.

Use DCW:VOLT:SWE:FALL to set the voltage fall time.

Command

```
[SOURCE:]DCW:VOLTage:SWEep:FALL:TIMer:STATe <boolean>
```

```
[SOURCE:]DCW:VOLTage:SWEep:FALL:TIMer:STATe?
```

Parameter

Value: ON(1) Set
OFF(0) Not set (default)

Settings is reset to default when the *RST command is sent.

Response: NR1

Example

```
DCW:VOLT:SWE:FALL:TIM:STAT ON
```

DCW:VOLT:SWE:TIM

Sets the voltage rise time for DC withstanding voltage tests.

Command

```
[SOURCE:]DCW:VOLTage:SWEep[:RISE]:TIMer <numeric>
```

```
[SOURCE:]DCW:VOLTage:SWEep[:RISE]:TIMer?
```

Unit: S

Settings is reset to default when the *RST command is sent. (0.1 S)

Response: NR3

Example

```
DCW:VOLT:SWE:TIM 0.1
```

DCW:VOLT:TIM

Sets the test time for DC withstanding voltage tests.

This setting is enabled when DCW:VOLT:TIM:STAT is set to ON.

Command

```
[SOURce:]DCW:VOLTage:TIMer <numeric>
```

```
[SOURce:]DCW:VOLTage:TIMer?
```

Unit: S

Settings is reset to default when the *RST command is sent. (0.2 S)

Response: NR3

Example

```
DCW:VOLT:TIM 500MS
```

DCW:VOLT:TIM:STAT

Sets whether to set the test time for DC withstanding voltage tests.

Use DCW:VOLT:TIM to set the test time.

Command

```
[SOURce:]DCW:VOLTage:TIMer:STATe <boolean>
```

```
[SOURce:]DCW:VOLTage:TIMer:STATe?
```

Parameter

Value: ON(1) Set (default)
OFF(0) Not set

Settings is reset to default when the *RST command is sent.

If the offset setting is set to ON (CALC:SCAL:OFFS:AUTO ON), the DCW:VOLT:TIM:STAT setting turns OFF when a test is performed.

Response: NR1

Example

```
DCW:VOLT:TIM:STAT ON
```

[SOURCE:]EC Command

EC:AC:CURR

Sets the test current for earth continuity tests (AC).

Command

```
[SOURCE:]EC:AC:CURRENT[:LEVEL][:IMMEDIATE][:AMPLITUDE] <numeric>  
[SOURCE:]EC:AC:CURRENT[:LEVEL][:IMMEDIATE][:AMPLITUDE]?
```

Unit: A

Settings is reset to default when the *RST command is sent. (3 A)

Response: NR3

Example

```
EC:AC:CURR 5
```

EC:AC:CURR:PROT

Sets the limit current for earth continuity tests (AC).

Command

```
[SOURCE:]EC:AC:CURRENT:PROTECTION[:LEVEL][:UPPER] <numeric>  
[SOURCE:]EC:AC:CURRENT:PROTECTION[:LEVEL][:UPPER]?
```

Unit: A

Settings is reset to default when the *RST command is sent. (42 A)

Response: NR3

Example

```
EC:AC:CURR:PROT 40
```

EC:AC:CURR:SWE:FALL:TIM

Sets the current fall time for earth continuity tests (AC).

This setting is enabled when EC:AC:CURR:SWE:FALL:TIM:STAT is set to ON.

Command

```
[SOURCE:]EC:AC:CURRENT:SWEep:FALL:TIMer <numeric>
```

```
[SOURCE:]EC:AC:CURRENT:SWEep:FALL:TIMer?
```

Unit: S

Settings is reset to default when the *RST command is sent. (0.1 S)

Response: NR3

Example

```
EC:AC:CURR:SWE:FALL:TIM 0.1S
```

EC:AC:CURR:SWE:FALL:TIM:STAT

Sets whether to set the current fall time for earth continuity tests (AC).

EC:AC:CURR:SWE:FALL:TIM to set the current fall time.

Command

```
[SOURCE:]EC:AC:CURRENT:SWEep:FALL:TIMer:STATe <boolean>
```

```
[SOURCE:]EC:AC:CURRENT:SWEep:FALL:TIMer:STATe?
```

Parameter

Value: ON(1) Set
OFF(0) Not set (default)

Settings is reset to default when the *RST command is sent.

Response: NR1

Example

```
EC:AC:CURR:SWE:FALL:TIM:STAT ON
```

EC:AC:CURR:SWE:TIM

Sets the current rise time for earth continuity tests (AC).

Command

```
[SOURCE:]EC:AC:CURRENT:SWEep[:RISE]:TIMER <numeric>
```

```
[SOURCE:]EC:AC:CURRENT:SWEep[:RISE]:TIMER?
```

Unit: S

Settings is reset to default when the *RST command is sent. (0.1 S)

Response: NR3

Example

```
EC:AC:CURR:SWE:TIM 1
```

EC:AC:CURR:TIM

Sets the test time for earth continuity tests (AC).

This setting is enabled when EC:AC:CURR:TIM:STAT is set to ON.

Command

```
[SOURCE:]EC:AC:CURRENT:TIMER <numeric>
```

```
[SOURCE:]EC:AC:CURRENT:TIMER?
```

Unit: S

Settings is reset to default when the *RST command is sent. (0.2 S)

Response: NR3

Example

```
EC:AC:CURR:TIM 5
```

EC:AC:CURR:TIM:STAT

Sets whether to set the test time for earth continuity tests (AC).

Use EC:AC:CURR:TIM to set the test time.

Command

```
[SOURCE:]EC:AC:CURRENT:TIMER:STATE <boolean>
```

```
[SOURCE:]EC:AC:CURRENT:TIMER:STATE?
```

Parameter

Value:	ON(1)	Set (default)
	OFF(0)	Not set

Settings is reset to default when the *RST command is sent.

If the offset setting is set to ON (CALC:SCAL:OFFS:AUTO ON), the EC:AC:CURR:TIM:STAT setting turns OFF when a test is performed.

Response: NR1

Example

```
EC:AC:CURR:TIM:STAT ON
```

EC:CURR:FREQ

Sets the test current frequency for earth continuity tests (AC).

Command

```
[SOURCE:]EC[:AC]:CURRENT:FREQUENCY <numeric>
```

```
[SOURCE:]EC[:AC]:CURRENT:FREQUENCY?
```

Unit: HZ

Settings is reset to default when the *RST command is sent. (50 HZ)

Response: NR3

Example

```
EC:CURR:FREQ 50HZ
```

EC:DC:CURR

Sets the test current for earth continuity tests (DC).

Command

```
[SOURCE:]EC:DC:CURRENT[:LEVEL][:IMMEDIATE][:AMPLITUDE] <numeric>
```

```
[SOURCE:]EC:DC:CURRENT[:LEVEL][:IMMEDIATE][:AMPLITUDE]?
```

Unit: A

Settings is reset to default when the *RST command is sent. (3 A)

Response: NR3

Example

```
EC:DC:CURR 40
```

EC:DC:CURR:PROT

Sets the limit current for earth continuity tests (DC).

Command

```
[SOURce:]EC:DC:CURRent:PROTection[:LEVel][:UPPer] <numeric>
```

```
[SOURce:]EC:DC:CURRent:PROTection[:LEVel][:UPPer]?
```

Unit: A

Settings is reset to default when the *RST command is sent. (42 A)

Response: NR3

Example

```
EC:DC:CURR:PROT 40
```

EC:DC:CURR:SWE:FALL:TIM

Sets the current fall time for earth continuity tests (DC).

This setting is enabled when EC:DC:CURR:SWE:FALL:TIM:STAT is set to ON.

Command

```
[SOURCE:]EC:DC:CURRENT:SWEep:FALL:TIMER <numeric>
```

```
[SOURCE:]EC:DC:CURRENT:SWEep:FALL:TIMER?
```

Unit: S

Settings is reset to default when the *RST command is sent. (0.1 S)

Response: NR3

Example

```
EC:DC:CURR:SWE:FALL:TIM 0.1S
```

EC:DC:CURR:SWE:FALL:TIM:STAT

Sets whether to set the current fall time for earth continuity tests (DC).

EC:DC:CURR:SWE:FALL:TIM to set the current fall time.

Command

```
[SOURCE:]EC:DC:CURRENT:SWEep:FALL:TIMER:STATE <boolean>
```

```
[SOURCE:]EC:DC:CURRENT:SWEep:FALL:TIMER:STATE?
```

Parameter

Value: ON(1) Set
OFF(0) Not set (default)

Settings is reset to default when the *RST command is sent.

Response: NR1

Example

```
EC:DC:CURR:SWE:FALL:TIM:STAT ON
```

EC:DC:CURR:SWE:TIM

Sets the current rise time for earth continuity tests (DC).

Command

```
[SOURce:]EC:DC:CURRent:SWEep[:RISE]:TIMer <numeric>
```

```
[SOURce:]EC:DC:CURRent:SWEep[:RISE]:TIMer?
```

Unit: S

Settings is reset to default when the *RST command is sent. (0.1 S)

Response: NR3

Example

```
EC:DC:CURR:SWE:TIM 1
```

EC:DC:CURR:TIM

Sets the test time for earth continuity tests (DC).

This setting is enabled when EC:DC:CURR:TIM:STAT is set to ON.

Command

```
[SOURCE:]EC:DC:CURREnt:TIMer <numeric>
```

```
[SOURCE:]EC:DC:CURREnt:TIMer?
```

Unit: S

Settings is reset to default when the *RST command is sent. (0.2 S)

Response: NR3

Example

```
EC:DC:CURR:TIM 500S
```

EC:DC:CURR:TIM:STAT

Sets whether to set the test time for earth continuity tests (DC).

Use EC:DC:CURR:TIM to set the test time.

Command

```
[SOURCE:]EC:DC:CURREnt:TIMer:STATe <boolean>
```

```
[SOURCE:]EC:DC:CURREnt:TIMer:STATe?
```

Parameter

Value:	ON(1)	Set (default)
	OFF(0)	Not set

Settings is reset to default when the *RST command is sent.

If the offset setting is set to ON (CALC:SCAL:OFFS:AUTO ON), the EC:DC:CURR:TIM:STAT setting turns OFF when a test is performed.

Response: NR1

Example

```
EC:DC:CURR:TIM:STAT ON
```

[SOURce:]IR command

IR:TERM:POL

Queries the polarity of the power supplied to the output terminals in insulation resistance tests.

Command

```
[SOURce:]IR:TERMinal:POLarity?
```

Response: character

NORM	Supplies power with normal phase
REV	Supplies power with reversed phase

Example

```
IR:TERM:POL?
```

Related command

```
IR:VOLT:RANG
```

IR:VOLT

Sets the test voltage for insulation resistance tests.

Command

```
[SOURce:]IR:VOLTage[:LEVel][:IMMediate][:AMPlitude] <numeric>  
[SOURce:]IR:VOLTage[:LEVel][:IMMediate][:AMPlitude]?
```

Unit: V

Settings is reset to default when the *RST command is sent. (0 V)

Response: NR3

Example

```
IR:VOLT 500
```

IR:VOLT:DISC:INT:STAT

Sets whether to discharge when interlock is activated in insulation resistance tests.

Command

```
[SOURCE:]IR:VOLTage:DISCharge:INTerlock:STATe <boolean>
```

```
[SOURCE:]IR:VOLTage:DISCharge:INTerlock:STATe?
```

Parameter

Value: ON(1) Discharge (default)
OFF(0) Not discharge

Settings is reset to default when the *RST command is sent.

Response: NR1

Example

```
IR:VOLT:DISC:INT:STAT ON
```

IR:VOLT:DISC:TIM

Sets the discharge time for insulation resistance tests.

Command

```
[SOURCE:]IR:VOLTage:DISCharge:TIMer[:MINimum] <numeric>
```

```
[SOURCE:]IR:VOLTage:DISCharge:TIMer[:MINimum]?
```

Unit: S

Settings is reset to default when the *RST command is sent. (0 S)

Response: NR3

Example

```
IR:VOLT:DISC:TIM 10S
```

IR:VOLT:PROT

Sets the limit voltage for insulation resistance tests.

Command

```
[SOURce:]IR:VOLTage:PROTection[:LEVel][:UPPer] <numeric>
```

```
[SOURce:]IR:VOLTage:PROTection[:LEVel][:UPPer]?
```

Unit: V

Settings is reset to default when the *RST command is sent. (1020 V)

Response: NR3

Example

```
IR:VOLT:PROT 500
```

IR:VOLT:RANG

Sets the output voltage range for insulation resistance tests.

The power supply line polarity is set to normal when 7500 V is specified and reverse when 1000 V is specified.

On the TOS9300 and TOS9302, the range is fixed to 1000 V (reverse polarity).

Command

```
[SOURce:]IR:VOLTage:RANGe <numeric>
```

```
[SOURce:]IR:VOLTage:RANGe?
```

Parameter

Value:	7200	Normal polarity (NORMal)
	1000	Reverse polarity (REVerse) (default)

Unit: V

Settings is reset to default when the *RST command is sent.

Response: NR3

Example

```
IR:VOLT:RANG 1000
```

Related command

```
IR:TERM:POL
```

IR:VOLT:STAR

Sets the start voltage as a percentage for insulation resistance tests.

This setting is enabled when IR:VOLT:STAR:STAT is set to ON.

Command

```
[SOURCE:]IR:VOLTage:START[:LEVel] <numeric>
```

```
[SOURCE:]IR:VOLTage:START[:LEVel]?
```

Unit: PCT

Settings is reset to default when the *RST command is sent. (50 PCT)

Response: NR3

Example

```
IR:VOLT:STAR 50PCT
```

IR:VOLT:STAR:STAT

Sets whether to set the start voltage for insulation resistance tests.

Use IR:VOLT:STAR to set the start voltage.

Command

```
[SOURCE:]IR:VOLTage:START:STATe <boolean>
```

```
[SOURCE:]IR:VOLTage:START:STATe?
```

Parameter

Value: ON(1) Set
OFF(0) Not set (default)

Settings is reset to default when the *RST command is sent.

Response: NR1

Example

```
IR:VOLT:STAR:STAT ON
```

IR:VOLT:SWE:TIM

Sets the voltage rise time for insulation resistance tests.

Command

```
[SOURCE:]IR:VOLTage:SWEep[:RISE]:TIMer <numeric>
```

```
[SOURCE:]IR:VOLTage:SWEep[:RISE]:TIMer?
```

Unit: S

Settings is reset to default when the *RST command is sent. (0.1 S)

Response: NR3

Example

```
IR:VOLT:SWE:TIM 1
```

IR:VOLT:TIM

Sets the test time for insulation resistance tests.

This setting is enabled when IR:VOLT:TIM:STAT is set to ON.

Command

```
[SOURce:]IR:VOLTage:TIMer <numeric>
```

```
[SOURce:]IR:VOLTage:TIMer?
```

Unit: S

Settings is reset to default when the *RST command is sent. (0.2 S)

Response: NR3

Example

```
IR:VOLT:TIM 5
```

IR:VOLT:TIM:STAT

Sets whether to set the test time for insulation resistance tests.

Use IR:VOLT:TIM to set the test time.

Command

```
[SOURce:]IR:VOLTage:TIMer:STATe <boolean>
```

```
[SOURce:]IR:VOLTage:TIMer:STATe?
```

Parameter

Value:	ON(1)	Set (default)
	OFF(0)	Not set

Settings is reset to default when the *RST command is sent.

If the offset setting is set to ON (CALC:SCAL:OFFS:AUTO ON), the IR:-VOLT:TIM:STAT setting turns OFF when a test is performed.

Response: NR1

Example

```
IR:VOLT:TIM:STAT ON
```

[SOURce:]PATient Command

PAT:110P:OUTP

Sets whether to apply the voltage applied from the 110% terminal to the AC LINE IN inlet in patient leakage current tests.

Command

```
[SOURce:]PATient[:TERMinal]:110Percent:OUTPut <boolean>
```

```
[SOURce:]PATient[:TERMinal]:110Percent:OUTPut?
```

Parameter

Value: ON(1) Apply
OFF(0) Not apply (default)

Settings is reset to default when the *RST command is sent.

Response: NR1

Example

```
PAT:110P:OUTP ON
```

PAT:110P:POL

Sets the polarity of the voltage applied from the 110% terminal in patient leakage current tests.

This setting is enabled when PAT:110P:OUTP is set to ON.

Command

```
[SOURce:]PATient[:TERMinal]:110Percent:POLarity <character>
```

```
[SOURce:]PATient[:TERMinal]:110Percent:POLarity?
```

Parameter

Value: NORMal Apply with normal phase (default)
REVerse Apply with reversed phase

Settings is reset to default when the *RST command is sent.

Response: character

Example

```
PAT:110P:POL NORM
```

PAT:POL

Sets the polarity of the power supply line supplied to the EUT for patient leakage current tests.

Command

```
[SOURCE:]PATient[:LINE]:POLarity <character>
```

```
[SOURCE:]PATient[:LINE]:POLarity
```

Parameter

Value:	NORMAL	Supply power with normal phase (default)
	REVERSE	Supply power with reversed phase

Settings is reset to default when the *RST command is sent.

Response: character

Example

```
PAT:POL NORM
```

[SOURce:]PCC Command

PCC:POL

Sets the polarity of the power supply line for protective conductor current tests.

Command

```
[SOURce:]PCCurrent[:LINE]:POLarity <character>
```

```
[SOURce:]PCCurrent[:LINE]:POLarity?
```

Parameter

Value:	NORMAL	Supply power with normal phase (default)
	REVERSE	Supply power with reversed phase

Settings is reset to default when the *RST command is sent.

Response: character

Example

```
PCC:POL NORM
```

[SOURce:]PD command

PD:VOLT

Sets the test voltage for partial discharge tests.

Command

```
[SOURce:]PD:VOLTage[:LEVel][:IMMediate][:AMPLitude] <numeric>
```

```
[SOURce:]PD:VOLTage[:LEVel][:IMMediate][:AMPLitude]?
```

Unit: V

Settings is reset to default when the *RST command is sent. (0 V)

Response: NR3

Example

```
PD:VOLT 1000V
```

PD:VOLT:FREQ

Sets the frequency for partial discharge tests.

Command

```
[SOURce:]PD:VOLTage:FREQuency <numeric>
```

```
[SOURce:]PD:VOLTage:FREQuency?
```

Parameter

Value: 50, 60

Unit: HZ

Settings is reset to default when the *RST command is sent. (50 HZ)

Response: NR3

Example

```
PD:VOLT:FREQ 50HZ
```

PD:VOLT:PATT

Sets the voltage pattern for partial discharge tests.

Command

```
[SOURce:]PD:VOLTage:PATTern <character>
```

```
[SOURce:]PD:VOLTage:PATTern?
```

Parameter

Value:	RAMP	Ramp (default)
	STEP	Step

Settings is reset to default when the *RST command is sent.

Response: character

Example

```
PD:VOLT:PATT RAMP
```

PD:VOLT:PROT

Sets the limit voltage for partial discharge tests.

Command

```
[SOURce:]PD:VOLTage:PROTection[:LEVel][:UPPer] <numeric>
```

```
[SOURce:]PD:VOLTage:PROTection[:LEVel][:UPPer]?
```

Unit: V

Settings is reset to default when the *RST command is sent. (5500 V)

Response: NR3

Example

```
PD:VOLT:PROT 1.5KV
```

PD:VOLT:SEC

Sets the 2nd test voltage for partial discharge tests.

This setting is enabled when PD:VOLT:PATT is set to RAMP.

Command

```
[SOURce:]PD:VOLTage:SECondary[:LEVel][:IMMediate][:AMPLitude]  
    <numeric>
```

```
[SOURce:]PD:VOLTage:SECondary[:LEVel][:IMMediate][:AMPLitude]?
```

Unit: V

Settings is reset to default when the *RST command is sent. (0 V)

Response: NR3

Example

```
PD:VOLT:SEC 1000V
```

PD:VOLT:SEC:SWE:FALL:TIM

Sets the 2nd voltage fall time for partial discharge tests.

This setting is enabled when PD:VOLT:PATT is set to RAMP.

Command

```
[SOURce:]PD:VOLTage:SECondary:SWEep:FALL:TIMer <numeric>
```

```
[SOURce:]PD:VOLTage:SECondary:SWEep:FALL:TIMer?
```

Unit: S

Settings is reset to default when the *RST command is sent. (1 S)

Response: NR3

Example

```
PD:VOLT:SEC:SWE:FALL:TIM 0.1S
```

PD:VOLT:SEC:TIM

Sets the 2nd test time for partial discharge tests.

This setting is enabled when PD:VOLT:PATT is set to RAMP and PD:-VOLT:SEC:TIM:STAT is set to ON.

Command

```
[SOURCE:]PD:VOLTage:SECondary:TIMer <numeric>
```

```
[SOURCE:]PD:VOLTage:SECondary:TIMer?
```

Unit: S

Settings is reset to default when the *RST command is sent. (1 S)

Response: NR3

Example

```
PD:VOLT:SEC:TIM 60S
```

PD:VOLT:SEC:TIM:STAT

Enables or disables the 2nd test time for partial discharge tests.

This setting is enabled when PD:VOLT:PATT is set to RAMP.

Use PD:VOLT:SEC:TIM to set the test time.

Command

```
[SOURCE:]PD:VOLTage:SECondary:TIMer:STATe <boolean>
```

```
[SOURCE:]PD:VOLTage:SECondary:TIMer:STATe?
```

Parameter

Value: ON(1) Enable. (default)
OFF(0) Disable.

Settings is reset to default when the *RST command is sent.

Response: NR1

Example

```
PD:VOLT:SEC:TIM:STAT ON
```

PD:VOLT:STEP

Sets the step voltage for partial discharge tests.

This setting is enabled when PD:VOLT:PATT is set to STEP.

Command

```
[SOURce:]PD:VOLTage:STEP[:LEVel][:IMMediate][:AMPLitude] <numeric>
```

```
[SOURce:]PD:VOLTage:STEP[:LEVel][:IMMediate][:AMPLitude]?
```

Unit: V

Settings is reset to default when the *RST command is sent. (0 V)

Response: NR3

Example

```
PD:VOLT:STEP 1000V
```

PD:VOLT:STEP:TIM

Sets the step time for partial discharge tests.

This setting is enabled when PD:VOLT:PATT is set to STEP.

Command

```
[SOURce:]PD:VOLTage:STEP:TIMer <numeric>
```

```
[SOURce:]PD:VOLTage:STEP:TIMer?
```

Unit: S

Settings is reset to default when the *RST command is sent. (1 S)

Response: NR3

Example

```
PD:VOLT:STEP:TIM 1S
```

PD:VOLT:SWE:FALL:TIM

Sets the voltage fall time for partial discharge tests.

This setting is enabled when PD:VOLT:PATT is set to RAMP and PD:-VOLT:SEC:TIM:STAT is set to ON.

Command

```
[SOURCE:]PD:VOLTage:SWEep:FALL:TIMer <numeric>
```

```
[SOURCE:]PD:VOLTage:SWEep:FALL:TIMer?
```

Unit: S

Settings is reset to default when the *RST command is sent. (1 S)

Response: NR3

Example

```
PD:VOLT:SWE:FALL:TIM 0.1S
```

PD:VOLT:SWE:FALL:TIM:STAT

Enables or disables the voltage fall time for partial discharge tests.

This setting is enabled when PD:VOLT:PATT is set to RAMP.

Use PD:VOLT:SWE:FALL:TIM to set the voltage fall time.

Command

```
[SOURCE:]PD:VOLTage:SWEep:FALL:TIMer:STATe <boolean>
```

```
[SOURCE:]PD:VOLTage:SWEep:FALL:TIMer:STATe?
```

Parameter

Value: ON(1) Enable. (default)
OFF(0) Disable.

Settings is reset to default when the *RST command is sent.

Response: NR1

Example

```
PD:VOLT:SWE:FALL:TIM:STAT ON
```

PD:VOLT:SWE:TIM

Sets the voltage rise time for partial discharge tests.

This setting is enabled when PD:VOLT:PATT is set to RAMP.

Command

```
[SOURce:]PD:VOLTage:SWEep[:RISE]:TIMer <numeric>
```

```
[SOURce:]PD:VOLTage:SWEep[:RISE]:TIMer?
```

Unit: S

Settings is reset to default when the *RST command is sent. (1 S)

Response: NR3

Example

```
PD:VOLT:SWE:TIM 1S
```

PD:VOLT:TIM

Sets the test time for partial discharge tests.

This setting is enabled when PD:VOLT:TIM:STAT is set to ON.

Command

```
[SOURce:]PD:VOLTage:TIMer <numeric>
```

```
[SOURce:]PD:VOLTage:TIMer?
```

Unit: S

Settings is reset to default when the *RST command is sent. (1 S)

Response: NR3

Example

```
PD:VOLT:TIM 60S
```

PD:VOLT:TIM:STAT

Enables or disables the test time for partial discharge tests.

Use PD:VOLT:TIM to set the test time.

Command

```
[SOURce:]PD:VOLTage:TIMer:STATe <boolean>
```

```
[SOURce:]PD:VOLTage:TIMer:STATe?
```

Parameter

Value: ON(1) Enable. (default)
OFF(0) Disable.

Settings is reset to default when the *RST command is sent.

Response: NR1

Example

```
PD:VOLT:TIM:STAT ON
```

[SOURCE:]TC Command

TC:110P:OUTP

Sets whether to apply the voltage applied from the 110% terminal to the AC LINE IN inlet in touch current tests.

Command

```
[SOURCE:]TC[:TERMINAL]:110Percent:OUTPut <boolean>
```

```
[SOURCE:]TC[:TERMINAL]:110Percent:OUTPut?
```

Parameter

Value: ON(1) Apply
OFF(0) Not apply (default)

Settings is reset to default when the *RST command is sent.

Response: NR1

Example

```
TC:110P:OUTP ON
```

TC:110P:POL

Sets the polarity of the voltage applied from the 110% terminal in touch current tests.

This setting is enabled when TC:110P:OUTP is set to ON.

Command

```
[SOURCE:]TC[:TERMINAL]:110Percent:POLarity <character>
```

```
[SOURCE:]TC[:TERMINAL]:110Percent:POLarity?
```

Parameter

Value: NORMal Apply with normal phase (default)
REVerse Apply with reversed phase

Settings is reset to default when the *RST command is sent.

Response: character

Example

```
TC:110P:POL NORM
```

TC:POL

Sets the polarity of the power supply line supplied to the EUT for touch current tests.

Command

```
[SOURCE:]TC[:LINE]:POLarity <character>
```

```
[SOURCE:]TC[:LINE]:POLarity?
```

Parameter

Value:	NORMAL	Supply power with normal phase (default)
	REVERSE	Supply power with reversed phase

Settings is reset to default when the *RST command is sent.

Response: character

Example

```
TC:POL NORM
```

STATUS Command

Status Report Structure

A "+" represents the logical OR of the register bits.

1999 SCPI Syntax & Style

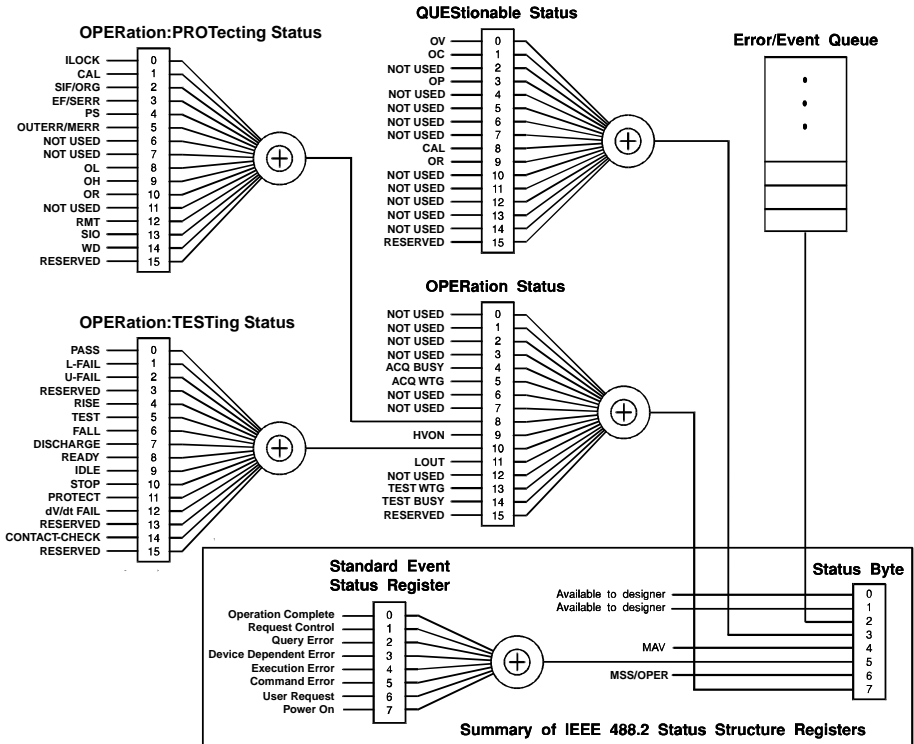

Architecture

IEEE 488.2 and SCPI registers are used for status reports.

In each SCPI status register, there are the following sub registers: the CONDition register, the EVENT register, the ENABle register, the PTRansition filter, and the NTRansition filter.

-> “Status Monitoring” (p. 345)

CONDition register

Transitions of the CONDition register are automatic and reflect the condition of the product in real time. Reading this register does not affect its contents.

EVENT register

The EVENT register bits are automatically set according to the changes in the CONDition register. The rule for setting the bits varies depending on the positive and negative transition registers (PTRansition and NTRansition). The EVENT register is reset when it is read.

ENABle register

The ENABle register enables reports to the summary bit or status bit of the event bits.

Transition filters

Use the PTRansition (positive transition) filter to report events when the condition changes from false to true.

Use the NTRansition (negative transition) filter to report events when the condition changes from true to false.

If both the positive filter and negative filter are set to true, events can be reported each time the status changes.

If both filters are cleared, event reporting is disabled.

Status byte register

The status byte register stores STB and RQS (MSS) messages as defined by the IEEE 488.1 standard. The status byte register can be read by using IEEE 488.1 serial polling or the IEEE 488.2 common command *STB?.

When the controller executes serial polling, bit 6 responds with request service (RQS). The status byte value is not changed by serial polling.

*STB? makes the device transmit the contents of the status byte register and the master status summary (MSS) message.

*STB? does not change the status byte, MSS, and RQS.

Bit	Bit weight	Bit name	Description
0	1	Reserved	Reserved for future use by IEEE 488. The bit value is notified as zero.
1	2	Reserved	
2	4	Error/Event Queue	If data exists in the error or event queue, this bit is set to true.
3	8	Questionable Status Register (QUES)	This bit is set to true when a bit is set in the QUESTIONable event status register and the corresponding bit in the QUESTIONable status enable register is true.
4	16	Message Available (MAV)	This bit is set to true when a request is received from the digital programming interface and the product is ready to generate the data byte.
5	32	Standard Event Status Bit Summary (ESB)	This bit is set to true when a bit is set in the event status register.
6	64	Request Service (RQS)	This bit is set to true when a bit is set in the service request enable register and the corresponding bit exists in the status byte. The SRQ line of the GPIB is set.
		Master Status Summary (MSS)	This bit is set to true when any bit in the status byte register is set to 1 and the corresponding bit in the service request enable register is set to 1.
7	128	Operation Status Register (OPER)	This bit is set to true when a bit is set in the OPERATION event status register and the corresponding bit in the OPERATION status enable register is set.
8-15		Not Used	Not used

Event status register

The event status register bits are set when certain events occur during product operation. All the event status register bits are set by the error event queue.

This register is defined by the IEEE 488.2 standard and is controlled using the IEEE 488.2 common commands *ESE, *ESE?, and *ESR?.

You can check the error content with SYST:ERR?.

Bit	Bit weight	Bit name	Description	Error number
0	1	Operation Complete(OPC)	Set when an *OPC command is received and all operations in standby have been completed.	-800 to -899
1	2	Request Control (RQC)	Not used	--
2	4	Query Error(QYE)	Set when an attempt is made to read data from the output queue when there is no data or when the output queue is not in the wait state. This indicates that there is no data in the output queue.	-400 to -499
3	8	Device Dependent Error(DDE)	Set when there is a device-specific error.	-300 to -399 100 to 999
4	16	Execution Error(EXE)	Set when the product evaluates that the program data after the header is outside the formal input range or does not match the specifications of the product. This indicates that a valid SCPI command may not be executed correctly depending on the state of the product.	-200 to -299
5	32	Command Error(CME)	Set when an IEEE 488.2 syntax error is detected by the parser, when an unidentifiable header is received, or when a group execution trigger enters the internal IEEE 488.2 SCPI command input buffer.	-100 to -199
6	64	User Request(URQ)	Not used	--
7	128	Power On(PON)	Not used	--
8-15		Reserved	Not used	--

OPERation status register

The OPERation status register is a 16-bit register that contains information about the normal operating conditions of the product.

Bit	Bit weight	Bit name	Description
0	1	NOT USED	Not used
1	2	NOT USED	Not used
2	4	NOT USED	Not used
3	8	NOT USED	Not used
4	16	MEASuring(ACQ BUSY)	Measurement is in progress.
5	32	ACQuire Waiting for TRIGger(ACQ WTG)	The product is waiting for a measurement trigger.
6	64	NOT USED	Not used
7	128	NOT USED	Not used
8	256	RROTECTing(PROT)	The PROTECTing status register bit is set.
9	512	Voltage ON(HVON)	Test in progress or voltage remaining across the output terminals
10	1024	TESTing(TEST)	The TESTing status register bit is set.
11	2048	Line Output(LOUT)	Line output or 110% terminal output in progress during an LC test
12	4096	NOT USED	Not used
13	8192	READY(TEST WTG)	The product is waiting for a test trigger.
14	16384	TEST is running(TEST BUSY)	Waiting for test execution or test in progress
15	32768	RESERVED	Always 0.

■ <bit-item>

The STAT:OPER command provides <bit-item> nodes. Refer to the table below to replace a <bit-item> with a necessary bit.

<bit-item>	Bit	Bit name
ABUS	4	MEASuring (ACQ BUSY)
AWTG	5	ACQuire Waiting for TRIGger (ACQ WTG)
HVON	9	Voltage ON (HVON)
LOUT	11	Line Output (LOUT)
TWTG	13	READY (TEST WTG)
TBUS	14	TEST is running(TEST BUSY)

STAT:OPER

Queries the event of the OPERation status register.

A query clears the contents of the register.

Command

```
STATus:OPERation[:EVENT]?
```

Response: NR1

STAT:OPER:<bit-item>

Queries the event of the specified bit in the OPERation status register bits.

A query clears the contents of the register.

For detail of <bit-item>, see “<bit-item>” on page 264.

Command

```
STATus:OPERation[:EVENT][:BIT]:<bit-item>?
```

Example

```
STAT:OPER:ABUS?
```

Response: NR1

1	Set
0	Not set

STAT:OPER:COND

Queries the condition of the OPERation status register.

A query does not clear the contents of the register.

Command

```
STATus:OPERation:CONDition?
```

Response: NR1

STAT:OPER:COND:<bit-item>

Queries the status of the specified bit in the OPERation status register bits.

A query does not clear the contents of the register.

For detail of <bit-item>, see "[<bit-item>](#)" on page 264.

Command

```
STATus:OPERation:CONDition[:BIT]:<bit-item>?
```

Example

```
STAT:OPER:COND:AWTG?
```

Response: NR1

1	Set
0	Not set

STAT:OPER:ENAB

Sets the enable register of the OPERation status register.

Command

```
STATus:OPERation:ENABle <NRf>
```

```
STATus:OPERation:ENABle?
```

Parameter

Value: 0 to 32767

Response: NR1

STAT:OPER:ENAB:<bit-item>

Sets the enable register of the specified bit in the OPERation status register.

For detail of <bit-item>, see “<bit-item>” on page 264.

Command

```
STATus:OPERation:ENABle[:BIT]:<bit-item> <boolean>
```

```
STATus:OPERation:ENABle[:BIT]:<bit-item>?
```

Parameter

Value: ON(1) Set
 OFF(0) Not set (default)

Example

```
STAT:OPER:ENAB:HVON ON
```

Response: NR1

STAT:OPER:NTR

Sets the negative transition filter of the OPERATION status register.

Command

```
STATus:OPERation:NTRansition <NRF>
```

```
STATus:OPERation:NTRansition?
```

Parameter

Value: 0 to 32767

Response: NR1

STAT:OPER:NTR:<bit-item>

Sets the negative transition filter of the specified bit in the OPERATION status register.

For detail of <bit-item>, see "[<bit-item>](#)" on page 264.

Command

```
STATus:OPERation:NTRansition[:BIT]:<bit-item> <boolean>
```

```
STATus:OPERation:NTRansition[:BIT]:<bit-item>?
```

Parameter

Value: ON(1) Set
OFF(0) Not set (default)

Example

```
STAT:OPER:NTR:LOUT ON
```

Response: NR1

STAT:OPER:PTR

Sets the positive transition filter of the OPERation status register.

Command

```
STATus:OPERation:PTRansition <NRf>
```

```
STATus:OPERation:PTRansition?
```

Parameter

Value: 0 to 32767

Response: NR1

STAT:OPER:PTR:<bit-item>

Sets the positive transition filter of the specified bit in the OPERation status register.

For detail of <bit-item>, see “<bit-item>” on page 264.

Command

```
STATus:OPERation:PTRansition[:BIT]:<bit-item> <boolean>
```

```
STATus:OPERation:PTRansition[:BIT]:<bit-item>?
```

Parameter

Value: ON(1) Set (default)
OFF(0) Not set

Example

```
STAT:OPER:PTR:TWTG ON
```

Response: NR1

OPERation:PROTeCting Status Register

The OPERation:PROTeCting status register is a 16-bit register that contains information about the status of the product's protection functions.

Bit	Bit weight	Bit name	Description
0	1	Interlock(ILOCK)	Interlock signal input detected.
1	2	Calibration(CAL)	The set calibration date has passed.
2	4	SCAN IF(SIF)/ Over Range(ORG)	Scanner cable disconnection/connection detected. The measurement upper limit was exceeded in LC current measurement mode.
3	8	Earth Fault(EF)	Ground current error detected.
4	16	Power Supply(PS)	Power supply problem detected.
5	32	Output Error(OUTERR)/ Measure Error(MERR)	The output voltage exceeded the rated limits. Measurement check error in an LC test
6	64	Short Error(SERR)	Relay operation error in an LC test
7	128	NOT USED	Not used
8	256	Over Load(OL)	The output power exceeded the output limit.
9	512	Over Heat(OH)	The internal temperature of the product has become abnormally high.
10	1024	Over Rating(OR)	An output current was generated for a length of time that exceeds the rated time.
11	2048	NOT USED	Not used
12	4096	Remote(RMT)	A connection or disconnection of the remote control connector was detected.
13	8192	SIGNAL I/O(SIO)	A change in the SIGNAL I/O connector's ENABLE signal was detected.
14	16384	Watchdog(WD)	Watchdog protection function was detected. Internal communication error detected
15	32768	RESERVED	Always 0.

STAT:OPER:PROT

Queries the event of the OPERATION:PROTECTing status register.

A query clears the contents of the register.

Command

```
STATus:OPERation:PROTECTing[:EVENT]?
```

Response: NR1

STAT:OPER:PROT:COND

Queries the condition of the OPERATION:PROTECTing status register.

A query does not clear the contents of the register.

Command

```
STATus:OPERation:PROTECTing:CONDition?
```

Response: NR1

STAT:OPER:PROT:ENAB

Sets the enable register of the OPERATION:PROTECTing status register.

Command

```
STATus:OPERation:PROTECTing:ENABLE <Nrf>
```

```
STATus:OPERation:PROTECTing:ENABLE?
```

Parameter

Value: 0 to 32767

Response: NR1

STAT:OPER:PROT:NTR

Sets the negative transition filter of the OPERATION:PROTECTing status register.

Command

```
STATus:OPERation:PROTECTing:NTRansition <Nrf>
```

```
STATus:OPERation:PROTECTing:NTRansition?
```

Parameter

Value: 0 to 32767

Response: NR1

STAT:OPER:PROT:PTR

Sets the positive transition filter of the OPERATION:PROTECTing status register.

Command

```
STATus:OPERation:PROTECTing:PTRansition <Nrf>
```

```
STATus:OPERation:PROTECTing:PTRansition?
```

Parameter

Value: 0 to 32767

Response: NR1

OPERation:TESTing Status Register

The OPERation:TESTing status register is a 16-bit register that contains information about the status of tests on the product.

Bit	Bit weight	Bit name	Description
0	1	PASS	PASS judgment
1	2	L-FAIL	L-FAIL judgment, C-FAIL judgment ^{*1} , dV/dt FAIL judgment ^{*2}
2	4	U-FAIL	U-FAIL judgment, C-FAIL judgment ^{*1} , dV/dt FAIL judgment ^{*3} , Coulomb FAIL judgment ^{*4} , Pulse Count FAIL judgment ^{*5}
3	8	RESERVED	Used for internal processing
4	16	RISE	Voltage rising
5	32	TEST	Testing
6	64	FALL	Voltage falling
7	128	DISCHARGE	Discharging
8	256	READY	Waiting for testing to start
9	512	IDLE	Standby
10	1024	STOP	Stopping testing
11	2048	PROTECT	Protection activated
12	4096	dV/dt / Coulomb FAIL	dV/dt FAIL judgment ^{*2, *3, *4}
13	8192	Pulse Count FAIL	Pulse Count FAIL judgment ^{*5}
14	16384	CONTACT-CHECK / Precalibration	Checking contact
15	32768	RESERVED	Always 0.

*1. When a judgment result is CONTACT-FAIL/Calibration-FAIL, bit 1 and bit 2 are set.

*2. When a judgment result is dV/dt FAIL in insulation resistance tests, bit 12 and bit 1 are set.

*3. When a judgment result is dV/dt FAIL in AC withstanding voltage tests, bit 12 and bit 2 are set.

*4. When a judgment result is coulomb FAIL in partial discharge tests, bit 12 and bit 2 are set.

*5. When a judgment result is pulse count FAIL in partial discharge tests, bit 13 and bit 2 are set.

STAT:OPER:TEST

Queries the event of the OPERATION:TESTing status register.

A query clears the contents of the register.

Command

```
STATus:OPERation:TESTing[:EVENT]?
```

Response: NR1

STAT:OPER:TEST:COND

Queries the condition of the OPERATION:TESTing status register.

A query does not clear the contents of the register.

Command

```
STATus:OPERation:TESTing:CONDition?
```

Response: NR1

STAT:OPER:TEST:ENAB

Sets the enable register of the OPERATION:TESTing status register.

Command

```
STATus:OPERation:TESTing:ENABle <Nrf>
```

```
STATus:OPERation:TESTing:ENABle?
```

Parameter

Value: 0 to 32767

Response: NR1

STAT:OPER:TEST:NTR

Sets the negative transition filter of the OPERation:TESTing status register.

Command

```
STATus:OPERation:TESTing:NTRansition <NRf>
```

```
STATus:OPERation:TESTing:NTRansition?
```

Parameter

Value: 0 to 32767

Response: NR1

STAT:OPER:TEST:PTR

Sets the positive transition filter of the OPERation:TESTing status register.

Command

```
STATus:OPERation:TESTing:PTRansition <NRf>
```

```
STATus:OPERation:TESTing:PTRansition?
```

Parameter

Value: 0 to 32767

Response: NR1

QUEStionable status register

The QUEStionable status register is a 16-bit register that stores information related to the product's status and the questionable events that occur during product operation.

The QUEStionable status register bits may indicate that there are problems with the product's measured data.

Bit	Bit weight	Bit name	Description
0	1	Over Voltage(OV)	Voltage measurement over-range
1	2	Over Current(OC)	Current measurement over-range
2	4	Over Coulomb(OQ)	Electric charge measurement over-range
3	8	Over Power(OP)	Power measurement over-range
4	16	NOT USED	Not used
5	32	NOT USED	Not used
6	64	NOT USED	Not used
7	128	NOT USED	Not used
8	256	CALibration(CAL)	The calibration date has passed.
9	512	Over Resistance(OR)	Resistance measurement over-range
10	1024	NOT USED	Not used
11	2048	NOT USED	Not used
12	4096	NOT USED	Not used
13	8192	NOT USED	Not used
14	16384	Overflow Pulse Count(OFPC)	Pulse count measurement overflow
15	32768	RESERVED	Always 0.

STAT:QUES

Queries the event of the QUEStionable status register.

A query clears the contents of the register.

Command

```
STATus:QUEStionable[:EVENT]?
```

Response: NR1

STAT:QUES:COND

Queries the condition of the QUEStionable status register.

A query does not clear the contents of the register.

Command

```
STATus:QUEStionable:CONDition?
```

Response: NR1

STAT:QUES:ENAB

Sets the enable register of the QUEStionable status register.

Command

```
STATus:QUEStionable:ENABle <NRf>
```

```
STATus:QUEStionable:ENABle?
```

Parameter

Value: 0 to 32767

Response: NR1

STAT:QUES:NTR

Sets the negative transition filter of the QUEStionable status register.

Command

```
STATus:QUEStionable:NTRansition <NRf>
```

```
STATus:QUEStionable:NTRansition?
```

Parameter

Value: 0 to 32767

Response: NR1

STAT:QUES:PTR

Sets the positive transition filter of the QUEStionable status register.

Command

```
STATus:QUEStionable:PTRansition <NRf>
```

```
STATus:QUEStionable:PTRansition?
```

Parameter

Value: 0 to 32767

Response: NR1

Preset status

STAT:PRES

Resets the ENABLE, PTRansition, and NTRansition filter registers of all status registers (including sub registers) to their default values.

Default values:

STATus:ENABle = 0x0000

STATus:PTRansition = 0x7FFF

STATus:NTRansition = 0x0000

Command

STATus:PRESet

SYSTEM Command

SYST:BEEP

Turns all buzzers on and off.

Command

```
SYSTem:BEEPer[:ALL][:STATe] <boolean>
```

```
SYSTem:BEEPer[:ALL][:STATe]?
```

Parameter

Value: ON(1) Buzzer on (default)
 OFF(0) Buzzer off

The setting may change when a SYST:BEEP:KEY, SYST:BEEP:PROT, or SYST:BEEP:SCPI is sent.

Response: NR1

Returns 1 when any buzzer is on when an invalid operation is executed, a protection function is activated, or an SCPI error occurs.

Returns 0 when all settings are off.

Example

```
SYST:BEEP OFF
```

SYST:BEEP:KEY

Turns on or off the buzzer that sounds when an invalid key is pressed.

Command

```
SYSTem:BEEPer:KEY[:STATe] <boolean>
```

```
SYSTem:BEEPer:KEY[:STATe]?
```

Parameter

Value: ON(1) Buzzer on (default)
 OFF(0) Buzzer off

The setting may change when a SYST:BEEP is sent.

Response: NR1

Example

```
SYST:BEEP:KEY ON
```

SYST:BEEP:PROT

Turns on or off the buzzer that sounds when a protection function is activated.

Command

```
SYSTem:BEEPer:PROTection[:STATe] <boolean>
```

```
SYSTem:BEEPer:PROTection[:STATe]?
```

Parameter

Value: ON(1) Buzzer on (default)
 OFF(0) Buzzer off

The setting may change when a SYST:BEEP is sent.

Response: NR1

Example

```
SYST:BEEP:PROT ON
```

SYST:BEEP:SCPI

Turns on or off the buzzer that sounds when an SCPI error occurs.

Command

```
SYSTem:BEEPer:SCPI[:STATe] <boolean>
```

```
SYSTem:BEEPer:SCPI[:STATe]?
```

Parameter

Value: ON(1) Buzzer on (default)
OFF(0) Buzzer off

The setting may change when a SYST:BEEP is sent.

Response: NR1

Example

```
SYST:BEEP:SCPI ON
```

SYST:COMM:PROT:WDOG

Enables or disables the communication monitoring (WATCHDOG) timer.

Use SYST:COMM:PROT:WDOG:DEL to set the delay time of the communication monitoring (WATCHDOG) timer.

Command

```
SYSTem:COMMunicate:PROTection:WDOG[:STATe] <boolean>
SYSTem:COMMunicate:PROTection:WDOG[:STATe]?
```

Parameter

Value: ON(1) Enables the communication monitoring timer
OFF(0) Disables the communication monitoring timer

Response: NR1

Example

```
SYST:COMM:PROT:WDOG ON
```

SYST:COMM:PROT:WDOG:DEL

Sets the delay time of the communication monitoring (WATCHDOG) timer.

This command is valid when the communication monitoring timer is enabled (SYST:COMM:PROT WDOG ON)

Command

```
SYSTem:COMMunicate:PROTection:WDOG:DELay <numeric>
SYSTem:COMMunicate:PROTection:WDOG:DELay?
```

Unit: S

Response: NR3

Example

```
SYST:COMM:PROT:WDOG:DEL 1S
```

SYST:COMM:RLST

Switches the TOS93 to local or remote mode.

Command

```
SYSTem:COMMunicate:RLState <character>
```

```
SYSTem:COMMunicate:RLState?
```

Parameter

Value:	LOCAL	Sets the product to local mode (Remote Disable; the RMT turns off). This enables both panel operations and commands. This is a substitute command for IEEE488.1 ren FALSE (Remote Disable). Resets the SAMPLE and TRIG:ACQ subsystems to their original defaults.
	REMOte	Switches the product to remote mode. All panel operations, except those of the LOCAL key, the START switch and the STOP switch, are locked. This is a substitute command for IEEE 488.1 ren (Remote Enable). This is also the substitute command for address specification.
	RWLock	Switches the product to remote mode. All panel controls are locked except the START switch and the STOP switch. This is a substitute command for IEEE 488.1 llo (Local Lock Out).

Response: character

Example

```
SYST:COMM:RLST REM
```

SYST:DATE

Sets the date.

Also set the time (SYST:TIME).

If you specify a day that does not exist (for example, February 30), the settings are changed to the first day of the following month.

Command

```
SYSTem:DATE <year_NR1>,<month_NR1>,<day_NR1>
```

```
SYSTem:DATE?
```

Parameter <year_NR1>

Value 2016 to 2037 Year

Parameter <month_NR1>

Value 1 to 12 Month

Parameter <day_NR1>

Value 1 to 31 Day

Response

Returns the year, month, and day in a comma-separated NR1 format.

Example

```
SYST:DATE 2015,4,14
```

SYST:ERR

Reads the oldest error information or event information from the error queue.

The error/event queue can hold up to 16 errors.-> “Error Checking”(p. 347)

The error queue is cleared if a *CLS command is sent.

Command

```
SYSTem:ERRor[:NEXT]?
```

Response

Returns the oldest error or event from the error/event queue in the following format, in response to SYST:ERR?.

Example: If there is no error or event

This command returns +0 "No error."

Example: If a command that cannot be executed in the present operating state is received

This command returns -221, "Settings conflict."

SYST:ERR:COUN

Returns the number of unread errors in the error queue.

Command

```
SYSTem:ERRor:COUNT?
```

Response: NR1

SYST:KLOC

Sets or releases panel control lock.

Invalid in remote mode (RMT lit).

Command

```
SYSTem:KLOCK <boolean>
```

```
SYSTem:KLOCK?
```

Parameter

Value: ON(1) Set the panel control lock
OFF(0) Release the panel control lock

Response: NR1

Example

```
SYSTem:KLOC ON
```

SYST:KLOC:LEV

Sets the panel control lock level.

Invalid in remote mode (RMT lit).

Command

```
SYSTem:KLOCK:LEVel <NRf>
```

```
SYSTem:KLOCK:LEVel?
```

Parameter

Value:	1	Low
	2	Medium
	3	High (default)

Response: NR1

Example

```
SYST:KLOC:LEV 3
```

SYST:PASS

Enables a password-protected command.

Command

```
SYSTem:PASSword[:CENable] "<string>"
```

```
SYSTem:PASSword[:CENable]?
```

Parameter

Value: The password set by SYST:PASS:NEW

Response: string

Example

```
SYST:PASS "password"
```

SYST:PASS:CDIS

Disables the password-protected command.

Command

```
SYSTem:PASSword:CDISable "<string>"
```

Parameter

Value: The password set by SYST:PASS:NEW

Example

```
SYST:PASS:CDIS "password"
```

SYST:PASS:NEW

Sets the password.

Command

```
SYSTem:PASSword:NEW "<string_exist>","<string_new>"
```

Parameter “<string_exist>”: existing password, “<string_new>”: new password

Naming convention: alphanumeric characters (A-Z, a-z, 0-9), underscore,
hyphen

Number of characters: 4 to 15

The factory default password is “”.

Example

```
SYST:PASS:NEW "existing password", "new password"
```

```
SYST:PASS:NEW "", "new password"
```

SYST:PASS:STAT

Queries the enabled/disabled state of the password-protected command.

Command

```
SYSTem:PASSword[:CENable]:STATe?
```

Response: NR1

Example

```
SYST:PASS:STAT?
```

SYST:LOC/ SYST:REM/ SYST:RWL

This is an old style command.

Use SYST:COMM:RLST(p. 284) when creating new programs.

Command

SYSTem:LOCal

SYSTem:REMOte

SYSTem:RWLock

SYST:SEC:IMM

Sanitizes all contents stored in memory and initializes the panel settings to their factory default conditions.

This command is valid when password protection is set (SYST:PASS).

Command

SYSTem:SECurity:IMMEDIATE

SYST:SSAV

Enables or disables the screen saver.

Use SYST:SSAV:DEL to set the time until the screen saver starts.

Command

```
SYSTem:SSAVer[:STATe] <boolean>
```

```
SYSTem:SSAVer[:STATe]?
```

Parameter

Value: ON(1) Enables the screen saver
OFF(0) Disables the screen saver (default)

Response: NR1

Example

```
SYST:SSAV ON
```

SYST:SSAV:DEL

Sets the time until the screen saver starts.

This command is valid when SYST:SSAV is set to ON.

Command

```
SYSTem:SSAVer:DELay <numeric>
```

```
SYSTem:SSAVer:DELay?
```

Parameter

Unit: S

Default: 60 S

Response: NR3

Example

```
SYST:SSAV:DEL 3600S
```

SYST:TIME

Sets the time.

Also set the date (using SYST:DATE).

Command

```
SYSTem:TIME <hour_NR1>,<min_NR1>,<sec_NR1>
```

```
SYSTem:TIME?
```

Parameter <hour_NR1>

Value 0 to 23 Hour

Parameter <min_NR1>

Value 0 to 59 Minutes

Parameter <sec_NR1>

Value 0 to 59 second

Response

Returns the hour, minute, and second in NR1 format.

Example

```
SYST:TIME 23,0,0
```

SYST:TIME:ADJ

Automatically synchronizes the system clock using the NTP server on the network.

Command

```
SYSTem:TIME:ADJust
```

SYST:TZON

Sets the time zone of the system clock.

Use SYST:TZON:CAT? to check the time zone ID.

Command

```
SYSTem:TZONE "<string>"
```

```
SYSTem:TZONE?
```

Parameter

Value: Time zone ID or UTC ("UTC" by default)

Response: "string"

Example

```
SYST:TZON "Asia/Tokyo"
```

SYST:TZON:CAT

Queries the time zone IDs that can be used.

Command

```
SYSTem:TZONE:CATalog?
```

Response: Comma-separated character string

SYST:VERS

Queries the version of the SCPI specifications that the product complies with.

Command

`SYSTem:VERSion?`

Response

Returns 1999.0.

SYSTem:CONFigure Command

SYST:CONF:BEEP:VOL

Sets the volume level of the buzzer that is sounded when a FAIL judgment occurs.

Command

```
SYSTem:CONFigure:BEEPer:VOLume[:FAIL] <Nrf>
```

```
SYSTem:CONFigure:BEEPer:VOLume[:FAIL]?
```

Parameter

Value: 0 to 10 (5 by default)

Response: NR1

Example

```
SYST:CONF:BEEP:VOL 5
```

SYST:CONF:BEEP:VOL:PASS

Sets the volume level of the buzzer that is sounded when a PASS judgment occurs.

Command

```
SYSTem:CONFigure:BEEPer:VOLume:PASS <Nrf>
```

```
SYSTem:CONFigure:BEEPer:VOLume:PASS?
```

Parameter

Value: 0 to 10 (3 by default)

Response: NR1

Example

```
SYST:CONF:BEEP:VOL:PASS 5
```

SYST:CONF:CAL:DUE:CONT

Sets the calibration period.

Command

```
SYSTem:CONFigure:CALibration:DUE:CONTRol <NRf>
```

```
SYSTem:CONFigure:CALibration:DUE:CONTRol?
```

Parameter

Value: 0 to 24 (Calibration period is not monitored when 0 is specified.)
(12 by default)

Unit: Month

Response: NR1

Example

```
SYST:CONF:CAL:DUE:CONT 5
```

SYST:CONF:CAL:PROT:STAT

Sets whether to activate the protection function and switch to protection mode when the calibration period is expired.

Use SYST:CONF:CAL:DUE:CONT to set the calibration period.

Command

```
SYSTem:CONFigure:CALibration:PROTection:STATe <boolean>
```

```
SYSTem:CONFigure:CALibration:PROTection:STATe?
```

Parameter

Value: ON(1) The product switches to protection mode.
OFF(0) The product does not switch to protection mode. (default)

Response: NR1

Example

```
SYST:CONF:CAL:PROT:STAT ON
```

SYST:CONF:DACT:STAT

Enables or disables the double action function.

Command

```
SYSTem:CONFigure:DACTion:STATe <boolean>
```

```
SYSTem:CONFigure:DACTion:STATe?
```

Parameter

Value: ON(1) Enables double action
OFF(0) Disables double action (default)

Response: NR1

Example

```
SYST:CONF:DACT:STAT ON
```

SYST:CONF:FMODE:STAT

Enables or disables the fail mode.

Command

```
SYSTem:CONFigure:FMODE:STATe <boolean>
```

```
SYSTem:CONFigure:FMODE:STATe?
```

Parameter

Value: ON(1) Enables fail mode
OFF(0) Disables fail mode (default)

Response: NR1

Example

```
SYST:CONF:FMODE:STAT ON
```

SYST:CONF:MOM:STAT

Enables/disables momentary.

Command

```
SYSTem:CONFigure:MOMentary:STATe <boolean>
```

```
SYSTem:CONFigure:MOMentary:STATe?
```

Parameter

Value: ON(1) Enables momentary
 OFF(0) Disables momentary (default)

Response: NR1

Example

```
SYST:CONF:MOM:STAT ON
```

SYST:CONF:PHOL

Sets the length of time that a PASS judgment result will be held.

Command

```
SYSTem:CONFigure:PHOLd {<NRf>|<character>}
```

```
SYSTem:CONFigure:PHOLd?
```

Parameter

Value: 0.05 to 10 (0.2 by default)
 INFinity Pass judgment results are displayed until you press STOP.

Unit: S

Response: NR3 or characters

Example

```
SYST:CONF:PHOL INF
```

SYST:CONF:PON:STAT

Sets the condition panel setting state when the POWER switch is turned on.

Command

```
SYSTem:CONFigure:PON:STATe <character>
```

```
SYSTem:CONFigure:PON:STATe?
```

Parameter

Value:	RST	Reset the panel settings
	RCL0	Settings stored in memory 0
	AUTO	The previous state before the POWER switch was turned off.

Response: characters

Example

```
SYST:CONF:PON:STAT AUTO
```

SYST:CONF:SIO:JUDG:STAT

Turns on or off the judgment result output at STEP END of the SIGNAL I/O connector.

Command

```
SYSTem:CONFigure:SIO[:SEND]:JUDgment:STATe <boolean>
```

```
SYSTem:CONFigure:SIO[:SEND]:JUDgment:STATe?
```

Parameter

Value:	ON(1)	Output
	OFF(0)	Not output (default)

Response: NR1

Example

```
SYST:CONF:SIO:JUDG:STAT ON
```

SYST:CONF:SLPR:STAT

Enables/disables the start long function.

Command

```
SYSTem:CONFigure:SLPRes:STATe <boolean>
```

```
SYSTem:CONFigure:SLPRes:STATe?
```

Parameter

Value: ON(1) Enables the start long function
 OFF(0) Disables the start long function (default)

Response: NR1

Example

```
SYST:CONF:SLPR:STAT ON
```

SYST:CONF:SOUT:FAIL:LOW:STAT

Sets whether to output a signal from the STATUS OUT connector during “L-FAIL.”

Command

```
SYSTem:CONFigure:SOUTput:FAIL:LOWer:STATe <boolean>
```

```
SYSTem:CONFigure:SOUTput:FAIL:LOWer:STATe?
```

Parameter

Value: ON(1) Output
 OFF(0) Not output (default)

Response: NR1

Example

```
SYST:CONF:SOUT:FAIL:LOW:STAT ON
```

SYST:CONF:SOUT:FAIL:UPP:STAT

Sets whether to output a signal from the STATUS OUT connector during “U-FAIL.”

Command

```
SYSTem:CONFIgure:SOUTput:FAIL:UPPer:STATe <boolean>
```

```
SYSTem:CONFIgure:SOUTput:FAIL:UPPer:STATe?
```

Parameter

Value: ON(1) Output
OFF(0) Not output (default)

Response: NR1

Example

```
SYST:CONF:SOUT:FAIL:UPP:STAT ON
```

SYST:CONF:SOUT:HVON:STAT

Sets whether to output a signal from the STATUS OUT connector while voltage is residing or while a test is in progress.

Command

```
SYSTem:CONFIgure:SOUTput:HVON:STATe <boolean>
```

```
SYSTem:CONFIgure:SOUTput:HVON:STATe?
```

Parameter

Value: ON(1) Output
OFF(0) Not output (default)

Response: NR1

Example

```
SYST:CONF:SOUT:HVON:STAT ON
```

SYST:CONF:SOUT:PASS:STAT

Sets whether to output a signal from the STATUS OUT connector during "PASS."

Command

```
SYSTem:CONFigure:SOUTput:PASS:STATe <boolean>
```

```
SYSTem:CONFigure:SOUTput:PASS:STATe?
```

Parameter

Value: ON(1) Output
 OFF(0) Not output (default)

Response: NR1

Example

```
SYST:CONF:SOUT:PASS:STAT ON
```

SYST:CONF:SOUT:PON:STAT

Sets whether to output a signal from the STATUS OUT connector while the POWER switch is turned on.

Command

```
SYSTem:CONFigure:SOUTput:PON:STATe <boolean>
```

```
SYSTem:CONFigure:SOUTput:PON:STATe?
```

Parameter

Value: ON(1) Output
 OFF(0) Not output (default)

Response: NR1

Example

```
SYST:CONF:SOUT:PON:STAT ON
```

SYST:CONF:SOUT:PROT:STAT

Sets whether to output a signal from the STATUS OUT connector during protection mode.

Command

```
SYSTem:CONFigure:SOUTput:PROTection:STATe <boolean>
```

```
SYSTem:CONFigure:SOUTput:PROTection:STATe?
```

Parameter

Value: ON(1) Output
OFF(0) Not output (default)

Response: NR1

Example

```
SYST:CONF:SOUT:PROT:STAT ON
```

SYST:CONF:SOUT:READ:STAT

Sets whether to output a signal from the STATUS OUT connector during “READY.”

Command

```
SYSTem:CONFigure:SOUTput:READy:STATe <boolean>
```

```
SYSTem:CONFigure:SOUTput:READy:STATe?
```

Parameter

Value: ON(1) Output
OFF(0) Not output (default)

Response: NR1

Example

```
SYST:CONF:SOUT:READ:STAT ON
```

SYST:CONF:SOUT:TEST:STAT

Sets whether to output a signal from the STATUS OUT connector while the test voltage is at the set value.

Command

```
SYSTem:CONFigure:SOUTput:TEST:STAT <boolean>
```

```
SYSTem:CONFigure:SOUTput:TEST:STAT?
```

Parameter

Value: ON(1) Output
 OFF(0) Not output (default)

Response: NR1

Example

```
SYST:CONF:SOUT:TEST:STAT ON
```

TRIGger Command

TRIG:ACQ

Executes a software trigger on the ACQ trigger subsystem.

Command

```
TRIGger:ACQuire[:IMMediate]
```

TRIG:ACQ:COUN

Sets the trigger count of the ACQ trigger subsystem.

Command

```
TRIGger:ACQuire:COUNT {<numeric>|<character>}  
TRIGger:ACQuire:COUNT?
```

Parameter

Value: 0 to 100 (1 by default)

Settings is reset to default when the *RST or MEAS command is sent.

When the local mode is enabled with the LOCAL key or by sending the SYST:COM-M:RLST LOC command, the setting is reset to its original default.

Response: NR1

Example

```
TRIG:ACQ:COUN 10
```

TRIG:ACQ:DEL

Sets the delay time from trigger application of the ACQ trigger subsystem until measured value recording.

Command

```
TRIGger:ACQuire:DElay {<numeric>|<character>}
```

```
TRIGger:ACQuire:DElay?
```

Parameter

Value: 0.0 to 100.0 (0.0 by default)

Unit: S

Resolution: 100 ms	AC withstanding voltage
	DC withstanding voltage
	Insulation resistance
	Earth continuity
	Partial discharge
1 s	Leakage current

Settings is reset to default when the *RST or MEAS command is sent.

When the local mode is enabled with the LOCAL key or by sending the SYST:COM-M:RLST LOC command, the setting is reset to its original default.

Response: NR3

Example

```
TRIG:ACQ:DEL 0S
```

TRIG:ACQ:SOUR

Sets the condition (trigger source) for actually starting the measurement after the ACQ trigger subsystem receives an INIT:ACQ.

Command

```
TRIGger:ACQuire:SOURce <character>
```

```
TRIGger:ACQuire:SOURce?
```

Parameter

Value:	IMMEDIATE	Immediately start the measurement.
	BUS	Execute the measurement when a software trigger (TRIG:ACQ) is received.
	TSTART	Measurement starts simultaneously with the start of a test. (default)

Settings is reset to default when the *RST command is sent.

Setting changes to IMM when the MEAS command is sent.

When the local mode is enabled with the LOCAL key or by sending the SYST:COM-M:RLST LOC command, the setting is reset to its original default.

Response: character

Example

```
TRIG:ACQ:SOUR IMM
```

TRIG:TEST

Executes a software trigger on the TEST trigger subsystem.

Command

```
TRIGger:TEST[:IMMEDIATE]
```

TRIG:TEST:SOUR

Sets the condition (trigger source) for actually starting the test after the TEST trigger subsystem receives an INIT:TEST.

Command

```
TRIGger:TEST:SOURce <character>
```

```
TRIGger:TEST:SOURce?
```

Parameter

Value:	IMMEDIATE	Immediately start the auto test. (default)
	BUS	Execute the auto test when a software trigger (TRIG:TEST) is received. In the case of FUNC PROG, the test pauses when a step is completed and resumes when a software trigger is received.
	EXTERNAL	Execute the auto test with a start operation on the TOS93. Pauses when a step is completed and resumes when a start operation is performed.
	ONCE	Execute the auto test with a start operation on the TOS93.

Settings is reset to default when the *RST command is sent.

Response: character

Example

```
TRIG:TEST:SOUR BUS
```

Tutorial

Withstanding voltage and insulation resistance test settings

■ Test condition setting commands for AC withstanding voltage tests (ACW)

Test condition	Command	Default
Test voltage	ACW:VOLT	0V
Limit voltage	ACW:VOLT:PROT	5500V
Start voltage	ACW:VOLT:STAR:STAT ACW:VOLT:STAR	OFF 50PCT
End voltage	ACW:VOLT:END:STAT	OFF
Frequency	ACW:VOLT:FREQ	50HZ
Upper limit	SENS:ACW:JUDG	0.01MA
Lower limit	SENS:ACW:JUDG:LOW:STAT SENS:ACW:JUDG:LOW	OFF 0A
Test time	ACW:VOLT:TIM:STAT ACW:VOLT:TIM	ON 0.2S
Voltage rise time	ACW:VOLT:SWE:TIM	0.1S
Voltage fall time	ACW:VOLT:SWE:FALL:TIM:STAT ACW:VOLT:SWE:FALL:TIM	OFF 0.1S
Current detection response speed	SENS:ACW:CURR:FILT:TYPE SENS:ACW:CURR:FILT:LPAS SENS:ACW:CURR:FILT:HPAS	LOW SLOW SLOW
Grounding mode	SENS:ACW:TERM:GRO	LOW
Current measurement mode	SENS:ACW:CURR:MODE	RMS
Voltage measurement mode	SENS:ACW:VOLT:MODE	RMS
Offset	CALC:ACW:SCAL CALC:ACW:SCAL:OFFS CALC:ACW:SCAL:OFFS:IMAG	OFF 0A 0A
Scanner setting	ROUT:ACW:TERM	*1, OPEN

*1. Specify the scanner and channel to set.

■ Test condition setting commands for DC withstanding voltage tests (DCW)

Test condition	Command	Default
Test voltage	DCW:VOLT	0V
Limit voltage	DCW:VOLT:PROT	7500V
Start voltage	DCW:VOLT:STAR:STAT DCW:VOLT:STAR	OFF 50PCT
End voltage	DCW:VOLT:END:STAT	OFF
Upper limit	SENS:DCW:JUDG	0.01MA
Lower limit	SENS:DCW:JUDG:LOW:STAT SENS:DCW:JUDG:LOW	OFF 0A
Auto setting of the judgment delay	SENS:DCW:JUDG:DEL:AUTO SENS:DCW:JUDG:DEL	OFF 0.1S
Test time	DCW:VOLT:TIM:STAT DCW:VOLT:TIM	ON 0.2S
Voltage rise time	DCW:VOLT:SWE:TIM	0.1S
Voltage fall time	DCW:VOLT:SWE:FALL:TIM:STAT DCW:VOLT:SWE:FALL:TIM	OFF 0.1S
Discharge time	DCW:VOLT:DISC:TIM	0S
Discharge when interlock is activated	DCW:VOLT:DISC:INT:STAT	ON
Current detection response speed	SENS:DCW:CURR:FILT:TYPE SENS:DCW:CURR:FILT:LPAS SENS:DCW:CURR:FILT:HPAS	LOW SLOW SLOW
Grounding mode	SENS:DCW:TERM:GRO	LOW
Voltage measurement mode	SENS:DCW:VOLT:MODE	AVER
Offset	CALC:DCW:SCAL CALC:DCW:SCAL:OFFS	OFF 0A
Scanner setting	ROUT:DCW:TERM	*1, OPEN

*1. Specify the scanner and channel to set.

■ Test condition setting commands for insulation resistance tests (IR)

Test condition	Command	Default
Test voltage	IR:VOLT	0V
Limit voltage	IR:VOLT:PROT	1020V
Start voltage	IR:VOLT:STAR:STAT IR:VOLT:STAR	OFF 50PCT
Upper limit	SENS:IR:JUDG:TYPE SENS:IR:JUDG:STAT SENS:IR:JUDG SENS:IR:JUDG:CURR:STAT SENS:IR:JUDG:CURR	RES OFF 100MOHM ON 0.0001MA
Lower limit	SENS:IR:JUDG:TYPE SENS:IR:JUDG:LOW:STAT SENS:IR:JUDG:LOW SENS:IR:JUDG:CURR:LOW:STAT SENS:IR:JUDG:CURR:LOW	RES ON 1MOHM OFF 0A
Auto setting of the judgment delay	SENS:IR:JUDG:DEL:AUTO SENS:IR:JUDG:DEL	OFF 0.1S
Test time	IR:VOLT:TIM:STAT IR:VOLT:TIM	ON 0.2S
Voltage rise time	IR:VOLT:SWE:TIM	0.1S
Discharge time	IR:VOLT:DISC:TIM	0S
Discharge when interlock is activated	IR:VOLT:DISC:INT:STAT	ON
Grounding mode	SENS:IR:TERM:GRO	LOW
Low-pass filter use	SENS:IR:CURR:FILT:LPAS:STAT	OFF
Offset	CALC:IR:SCAL CALC:IR:SCAL:OFFS	OFF 100MOHM
Scanner setting	ROUT:IR:TERM	*1, OPEN

*1. Specify the scanner and channel to set.

■ Set test conditions

First, switch to remote mode.

```
SYST:COMM:RLST REM
```

Reset the settings. When you reset the settings, the set values are reset to the default values.

```
*RST
```

Next, select the test mode.

AC withstanding voltage test

```
FUNC ACW
```

The DC withstanding voltage test parameter is DCW, and the insulation resistance test parameter is IR.

Next, set the test conditions.

When performing an AC withstanding voltage test with the test voltage set to 1500 V, the upper limit set to 10 mA, the test time set to 60 s, the voltage rise time set to 5 s, and the rest of the settings set to default

```
ACW:VOLT 1500
```

```
SENS:ACW:JUDG 10MA
```

```
ACW:VOLT:TIM 60
```

```
ACW:VOLT:SWE:TIM 5
```

The test time can be set to off. When set to off, the test continues until you press STOP or send ABOR.

```
ACW:VOLT:TIM:STAT OFF
```

When set to off, the test time set with ACW:VOLT:TIM is invalid. If you want to set the test time again, set it to on.

```
ACW:VOLT:TIM:STAT ON
```

In an AC withstanding voltage test, the default start voltage, lower limit, voltage fall time, and offset are off.

In a DC withstanding voltage test, the default start voltage, lower limit, auto setting of the judgment delay, voltage fall time, and offset are off.

In an insulation resistance test, the default start voltage, upper limit, auto setting of the judgment delay, and offset are off.

If you want to set them, set them to on and then set the values.

Start voltage in an AC withstanding voltage test

```
ACW:VOLT:STAR:STAT ON
```

```
ACW:VOLT:STAR 50PCT
```

In an AC withstanding voltage test or DC withstanding voltage test, the current detection response speed can be set. The default value is LPF slow.

Select whether to use the LPF or HPF, and then set the speed.

When using HPF fast in an AC withstanding voltage test

```
SENS:ACW:CURR:FILT:TYPE HIGH
```

```
SENS:ACW:CURR:FILT:HPAS FAST
```

In an insulation resistance test, you can set the upper limit and lower limit using a resistance or current. The default settings is resistance with the upper limit set to off and lower limit set to on.

When judging based on current

```
SENS:IR:JUDG:TYPE CURR
```

```
SENS:IR:JUDG:CURR:STAT ON
```

```
SENS:IR:JUDG:CURR 0.01MA
```

```
SENS:IR:JUDG:CURR:LOW 0.001MA
```

You can set the lower limit to off.

```
SENS:IR:JUDG:CURR:LOW:STAT OFF
```

If an optional high voltage scanner is connected, set the connection of each channel of the scanner.

You can query the available scanner channels.

```
ROUT:CAT?
```

Returns the available scanner channel in <NR1>,<NR1>... format. If scanner 1 (channels 1 to 4) is connected, +101,+102,+103,+104 is returned.

Specify the scanner channel, and then set the connection.

When setting scanner 1 channel 2 to LOW (DC withstanding voltage test)

```
ROUT:DCW:TERM 102,LOW
```

When you are done with the settings, start the test.

Earth continuity test (EC) settings

■ Test condition setting commands for earth continuity (AC) tests

Test condition	Command	Default
Test current	EC:AC:CURR	3A
Limit current	EC:AC:CURR:PROT	42A
Frequency	EC:CURR:FREQ	50
Upper limit	SENS:EC:AC:JUDG:TYPE SENS:EC:AC:JUDG:STAT SENS:EC:AC:JUDG SENS:EC:AC:JUDG:VOLT:STAT SENS:EC:AC:JUDG:VOLT	RES ON 0.0001OHM ON 2.5V
Lower limit	SENS:EC:AC:JUDG:TYPE SENS:EC:AC:JUDG:LOW:STAT SENS:EC:AC:JUDG:LOW SENS:EC:AC:JUDG:VOLT:LOW:STAT SENS:EC:AC:JUDG:VOLT:LOW	RES OFF 0OHM OFF 0V
Test time	EC:AC:CURR:TIM:STAT EC:AC:CURR:TIM	ON 0.2S
Current rise time	EC:AC:CURR:SWE:TIM	0.1S
Current fall time	EC:AC:CURR:SWE:FALL:TIM:STAT EC:AC:CURR:SWE:FALL:TIM	OFF 0.1S
Terminal wiring method	SENS:EC:AC:TERM:WIRE	4
Offset	CALC:EC:AC:SCAL CALC:EC:AC:SCAL:OFFS	OFF 0OHM
Contact check	SENS:EC:AC:TERM:CCH	OFF

■ Test condition setting commands for earth continuity (DC) tests

Test condition	Command	Default
Test current	EC:DC:CURR	3A
Limit current	EC:DC:CURR:PROT	42A
Upper limit	SENS:EC:DC:JUDG:TYPE SENS:EC:DC:JUDG:STAT SENS:EC:DC:JUDG SENS:EC:DC:JUDG:VOLT:STAT SENS:EC:DC:JUDG:VOLT	RES ON 0.0001OHM ON 2.5V
Lower limit	SENS:EC:DC:JUDG:TYPE SENS:EC:DC:JUDG:LOW:STAT SENS:EC:DC:JUDG:LOW SENS:EC:DC:JUDG:VOLT:LOW:STAT SENS:EC:DC:JUDG:VOLT:LOW	RES OFF 0OHM OFF 0V
Test time	EC:DC:CURR:TIM:STAT EC:DC:CURR:TIM	ON 0.2S
Current rise time	EC:DC:CURR:SWE:TIM	0.1S
Current fall time	EC:DC:CURR:SWE:FALL:TIM:STAT EC:DC:CURR:SWE:FALL:TIM	OFF 0.1S
Terminal wiring method	SENS:EC:DC:TERM:WIRE	4
Offset	CALC:EC:DC:SCAL CALC:EC:DC:SCAL:OFFS	OFF 0OHM
Contact check	SENS:EC:DC:TERM:CCH	OFF

■ Set test conditions

First, switch to remote mode.

```
SYST:COMM:RLST REM
```

Reset the settings. When you reset the settings, the set values are reset to the default values.

```
*RST
```

Next, select the test mode.

Earth continuity (AC) test

```
FUNC EC
```

The earth continuity (DC) test parameter is ECDC.

Next, set the test conditions.

An earth continuity (AC) test will be used as an example to explain the steps.

In the case of DC, replace AC in the node to DC.

When performing a test with the test voltage set to 25 A, the upper limit set to 0.1 Ω,

the test time set to 60 s, and the rest of the settings set to default

```
EC:AC:CURR 25
```

```
SENS:EC:AC:JUDG 0.1
```

```
EC:AC:CURR:TIM 60
```

The test time can be set to off. When set to off, the test continues until you press STOP or send ABOR.

```
EC:AC:CURR:TIM:STAT OFF
```

When set to off, the test time set with EC:AC:CURR:TIM is invalid. If you want to set the test time again, set it to on.

```
EC:AC:CURR:TIM:STAT ON
```

The default lower limit, current fall time, and offset are off.

If you want to set them, set them to on and then set the values.

Current fall time

```
EC:AC:CURR:SWE:FALL:TIM:STAT ON
```

```
EC:AC:CURR:SWE:FALL:TIM 0.1
```

You can set the upper limit and lower limit using a resistance or voltage.

The default settings is resistance with the upper limit set to on and lower limit set to off.

When judging based on voltage

```
SENS:EC:AC:JUDG:TYPE VOLT
```

```
SENS:EC:AC:JUDG:VOLT:STAT ON
```

```
SENS:EC:AC:JUDG:VOLT 2.5V
```

```
SENS:EC:AC:JUDG:VOLT:LOW 0.1V
```

You can set the upper limit to off.

```
SENS:EC:AC:JUDG:VOLT:STAT OFF
```

When you are done with the settings, start the test.

Partial discharge (PD) settings

■ Test condition setting commands for Partial discharge (PD)

Test condition	Command	Default
Test voltage	PD:VOLT	0V
2nd test voltage	PD:VOLT:SEC	0V
Limit voltage	PD:VOLT:PROT	5500V
Step voltage	PD:VOLT:STEP	0V
Voltage pattern	PD:VOLT:PATT	RAMP
Frequency	PD:VOLT:FREQ	50HZ
Reference discharge electric charge for upper limit judgment	SENS:PD:JUDG SENS:PD:JUDG:STAT	10000PC ON
Upper limit number of times the electric charge	SENS:PD:JUDG:PCO SENS:PD:JUDG:PCO:STAT	1 ON
Electric charge threshold	SENS:PD:PCO:THR	25PCT
Test time	PD:VOLT:TIM PD:VOLT:TIM:STAT	1S ON
2nd test time	PD:VOLT:SEC:TIM PD:VOLT:SEC:TIM:STAT	1S ON
Step time	PD:VOLT:STEP:TIM	1S
Voltage rise time	PD:VOLT:SWE:TIM	1S
Voltage fall time	PD:VOLT:SWE:FALL:TIM PD:VOLT:SWE:FALL:TIM:STAT	1S ON
2nd voltage fall time	PD:VOLT:SEC:SWE:FALL:TIM	1S
Electric charge to judge the discharge inception voltage	CALC:PD:VOLT:INC:THR	1000PC
Electric charge to judge the discharge extinction voltage	CALC:PD:VOLT:EXT:THR	1000PC
Measurement range	SENS:PD:RANG	10000PC
Bandwidth	SENS:PD:FILT:BPAS	160KHZ
Low Pass Filter	SENS:PD:FILT:LPAS:STAT	OFF
Voltage measurement mode	SENS:PD:VOLT:MODE	RMS
Calibration of a discharge electric charge	CALC:PD:PREC	EVER
Display method for the graph scale	GRAP:PD:SCAL	FIX
Inc/Ext-Volt Maker	GRAP:PD:MARK	ON
Graph Format	GRAP:PD:FORM	QT

■ Set test conditions

First, switch to remote mode.

```
SYST:COMM:RLST REM
```

Reset the settings. When you reset the settings, the set values are reset to the default values.

```
*RST
```

Next, select the test mode.

```
FUNC PD
```

Next, set the test conditions.

The following settings when RAMP is selected will be used as an example to explain how to set test conditions.

When performing a test with the voltage pattern set to RAMP (default), the test voltage set to 1500 V, the voltage rise time set to 10 s, the test time set to 10 s, the voltage fall time set to 10 s, and the rest of the settings set to default

```
PD:VOLT 1500
PD:VOLT:SWE:RISE:TIM 10
PD:VOLT:TIM 10
PD:VOLT:SWE:FALL:TIM 10
PD:VOLT:SEC:TIM:STAT OFF
```

The test time can be set to off. When set to off, the test continues until you press STOP or send ABOR.

```
PD:VOLT:TIM:STAT OFF
```

When set to off, the test time set with PD:VOLT:TIM is invalid. If you want to set the test time again, set it to on.

```
PD:VOLT:TIM:STAT ON
```

The electric charge to judge the discharge inception/extinction voltage can be set.

```
CALC:PD:VOLT:INC:THR 10PC
CALC:PD:VOLT:EXT:THR 10PC
```

When judging based on Upper Coulomb set to 8000 pc and Upper Pulse Count set to 2000

```
SENS:PD:JUDG 8000PC
SENS:PD:JUDG:PCO 2000
```

When you are done with the settings, start the test.

Leakage current test settings

■ Test condition setting commands for touch current tests (TC)

Test condition	Command	Default
Network	SENS:TC:NETW	A
Power supply line polarity	TC:POL	NORM
Single fault mode	SENS:TC:COND SENS:TC:COND:FAUL	NORM NEUT
Probe connection destination	SENS:TC:NETW:PROB	PEAR
Output from the 110% terminal	TC:110P:OUTP TC:110P:POL	OFF NORM
Upper limit	SENS:TC:JUDG:STAT SENS:TC:JUDG	ON 100UA
Lower limit	SENS:TC:JUDG:LOW:STAT SENS:TC:JUDG:LOW	OFF 0.01MA
Judgment delay	SENS:TC:JUDG:DEL:STAT SENS:TC:JUDG:DEL	OFF 1S
Test time	SENS:TC:TIM:STAT SENS:TC:TIM	ON 1S
Voltage conversion	CALC:TC:SCAL:CONV CALC:TC:SCAL:CONV:VOLT	OFF 80V
Measurement mode	SENS:TC:CURR:MODE	ACDC
Measurement range	SENS:TC:RANG:AUTO	ON
Voltmeter band expansion	SENS:TC:BAND	NORM
Offset	CALC:TC:SCAL CALC:TC:SCAL:OFFS	OFF 0A

■ Test condition setting commands for protective conductor current test (PCC)

Test condition	Command	Default
Network	SENS:PCC:NETW	PCC-1
Power supply line polarity	PCC:POL	NORM
Single fault mode	SENS:PCC:COND	NORM
Upper limit	SENS:PCC:JUDG:STAT SENS:PCC:JUDG	ON 100UA
Lower limit	SENS:PCC:JUDG:LOW:STAT SENS:PCC:JUDG:LOW	OFF 0.01MA
Judgment delay	SENS:PCC:JUDG:DEL:STAT SENS:PCC:JUDG:DEL	OFF 1S
Test time	SENS:PCC:TIM:STAT SENS:PCC:TIM	ON 1S
Voltage conversion	CALC:PCC:SCAL:CONV CALC:PCC:SCAL:CONV:VOLT	OFF 80V
Measurement mode	SENS:PCC:CURR:MODE	ACDC
Measurement range	SENS:PCC:RANG:AUTO	ON
Voltmeter band expansion	SENS:PCC:BAND	NORM
Offset	CALC:PCC:SCAL CALC:PCC:SCAL:OFFS	OFF 0A

■ Test condition setting commands for patient leakage current tests (PAT)

Test condition	Command	Default
Power supply line polarity	PAT:POL	NORM
Single fault mode	SENS:PAT:COND SENS:PAT:COND:FAUL	NORM NEUT
Probe connection destination	SENS:PAT:NETW:PROB	PEAR
Output from the 110% terminal	PAT:110P:OUTP PAT:110P:POL	OFF NORM
Upper limit	SENS:PAT:JUDG:STAT SENS:PAT:JUDG	ON 0.1MA
Lower limit	SENS:PAT:JUDG:LOW:STAT SENS:PAT:JUDG:LOW	OFF 0.01MA
Judgment delay	SENS:PAT:JUDG:DEL:STAT SENS:PAT:JUDG:DEL	OFF 1S
Test time	SENS:PAT:TIM:STAT SENS:PAT:TIM	ON 1S
Voltage conversion	CALC:PAT:SCAL:CONV CALC:PAT:SCAL:CONV:VOLT	OFF 80V
Measurement mode	SENS:PAT:CURR:MODE	ACDC
Measurement range	SENS:PAT:RANG:AUTO	ON
Voltmeter band expansion	SENS:PAT:BAND	NORM
Offset	CALC:PAT:SCAL CALC:PAT:SCAL:OFFS	OFF 0A

■ Test condition setting commands for meter mode (MET)

Test condition	Command	Default
Network	SENS:MET:NETW	A
Touch mode	SENS:MET:TERM	NETW
SELV setting	SENS:MET:SELV:STAT SENS:MET:SELV	ON 30V
Measurement mode	SENS:MET:CURR:MODE	ACDC
Measurement range	SENS:MET:RANG:AUTO SENS:MET:RANG	ON 42V
Offset	CALC:MET:SCAL CALC:MET:SCAL:OFFS	OFF 0A
Output from the 110% terminal	OUTP:110P OUTP:110P:POL	OFF NORM

■ Set test conditions.

First, switch to remote mode.

```
SYST:COMM:RLST REM
```

Reset the settings. When you reset the settings, the set values are reset to the

default values.

```
*RST
```

Next, select the test mode.

Touch current test

```
FUNC TC
```

The protective conductor current test parameter is PCC, the patient leakage current test parameter is PAT, and meter mode is MET.

Next, set the test conditions.

When performing a touch current test with the network set to B-U1, the upper limit set to 0.5 mA, the test time set to 10 s, and the rest of the settings set to default

```
SENS:TC:NETW B-U1
```

```
SENS:TC:JUDG 0.5MA
```

```
SENS:TC:TIM 10
```

The test time can be set to off. When set to off, the test continues until you press STOP or send ABOR.

```
SENS:TC:TIM:STAT OFF
```

When set to off, the test time set with SENS:TC:TIM is invalid. If you want to set the test time again, set it to on.

```
SENS:TC:TIM:STAT ON
```

You can also set the upper limit to off.

```
SENS:TC:JUDG:STAT OFF
```

In a touch current test, protective conductor current test, or patient leakage current test, the default lower limit, judgment delay, voltage conversion, and offset are off.

In meter mode, the default offset is off.

If you want to set them, set them to on and then set the values.

Judgment delay in a touch current test

```
SENS:TC:JUDG:DEL:STAT ON
```

```
SENS:TC:JUDG:DEL 1S
```

In a touch current test or patient leakage current test, you can set the disconnected condition of single fault mode to power supply line or protective ground wire. The default is normal (NORM).

When setting the disconnected condition to protective ground wire in a touch cur-

rent test

```
SENS:TC:COND FAUL
```

```
SENS:TC:COND:FAUL PEAR
```

When you are done with the settings, start the test.

Trigger Subsystem

This product has two different trigger subsystems.

- TEST

Executes a test/ auto test.

- ACQuire

Measures the voltage, current, resistance, and elapsed test time.

The trigger subsystems have three states (IDLE state, INITiated state, WTG state).

- IDLE state

When the product is turned on, all trigger subsystems are in the IDLE state. In this state, the trigger subsystem ignores all triggers. If you send any of the following commands, the trigger subsystem is switched to the IDLE state, regardless of its current state.

```
ABORt
```

```
*RST
```

```
*RCL
```

```
IEEE488.1 sdc (Selected Device Clear) or dcl (Device Clear)
```

- INITiated state

When you send the INIT command while the product is in the IDLE state, the trigger function begins operating, and the tester switches to the INITiated state.

If the trigger source is set to IMMEDIATE, the test, the auto test, or the measurement immediately.

If the trigger source is set to BUS, the product switches to the WTG (Waiting for Trigger) state. If the trigger source is set to EXT/ ONCE, the product switches to WTG (Waiting for Trigger) state, which causes the product to wait for a start operation to take place on the TOS.

- WTG (Waiting for Trigger) state

When you send a trigger or perform a start operation on the TOS93 in the WTG state, test, auto test, or measurement starts.

Executing tests

Tests use the TEST trigger subsystem.

First, set the test conditions.

■ Before starting a test

In a withstanding voltage test or insulation resistance test, you can check the continuity between the test leads connected to the scanner and the EUT.

AC withstanding voltage test

```
ROUT:ACW:TERM:CCH ON
```

DC withstanding voltage test

```
ROUT:DCW:TERM:CCH ON
```

Insulation resistance test

```
ROUT:IR:TERM:CCH ON
```

In a touch current test, protective conductor current test, or patient leakage current test, a current can be output temporarily from AC LINE OUT for checking the operation of the EUT.

```
OUTP ON
```

■ Starting a test

The TEST trigger subsystem has three states: IDLE, INITiated, and WTG.

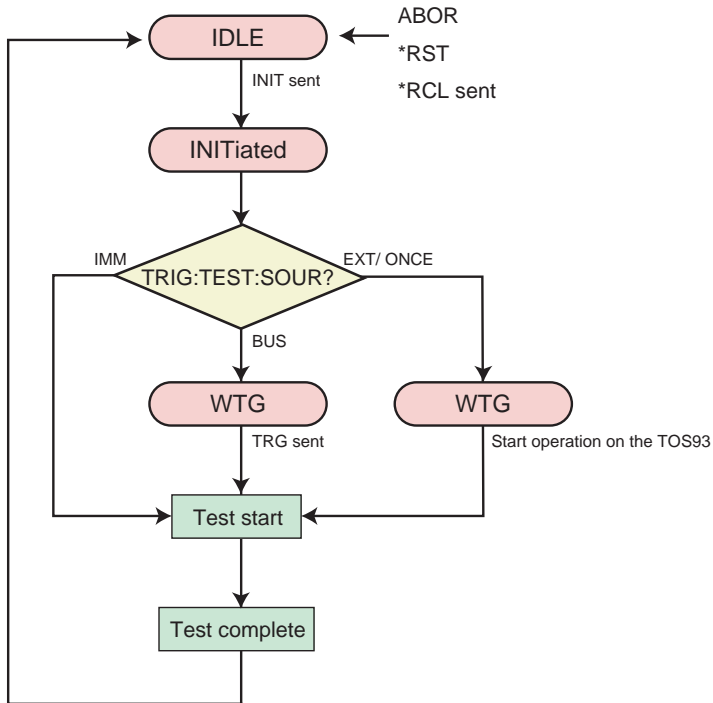

To start a test immediately, set the trigger source to IMM, and then use the INIT command.

```
TRIG:TEST:SOUR IMM
INIT:TEST
```

To start a test with a software trigger, change the trigger source to BUS. When you send INIT:TEST, the trigger subsystem switches to the WTG (Waiting For Trigger) state. When a software trigger is received through TRIG:TEST or *TRG, the test starts.

```
TRIG:TEST:SOUR BUS
INIT:TEST
TRIG:TEST
```

To start a test from the TOS93, change the trigger source to EXT. When you send INIT:TEST, the trigger subsystem switches to the WTG (Waiting For Trigger) state. The test starts when you perform a start operation on the unit.

```
TRIG:TEST:SOUR EXT
INIT:TEST
```

When the test finishes, the trigger subsystem returns to the IDLE state again. If the ABOR command or an equivalent command is received in the WTG state or when a test is being executed, the test is canceled, and the trigger subsystem returns to the IDLE state.

Send an *RST command to reset all the test condition parameters.

TRIG:TEST applies a software trigger only to the TEST trigger subsystem.

You can also use the *TRG command or the IEEE488.1 get (Group Execute Trigger) command for the same purpose. This command applies a software trigger to all trigger subsystems, if there are other trigger subsystems in the initiated state, their trigger operations will also be executed at the same time. The TEST subsystem and the PROG subsystem cannot be executed simultaneously. The trigger operation of the item selected with FUNC is executed.

Configuring and executing auto tests

Auto tests use the TEST trigger subsystem.

■ Setting the step and program conditions

First, switch to remote mode.

```
SYST:COMM:RLST REM
```

Reset the settings. When you reset the settings, the set values are reset to the default values.

```
*RST
```

Next, set the test mode to auto test.

```
FUNC PROG
```

To create a new program, specify a program name. If you are using a program in program memory, you do not need to create a program.

For tests other than an LC test, include "/BASIC/" before the program name. For an LC test, include "/LC/".

When creating a test other than an LC test

```
PROG:CRE "/BASIC/MY TEST"
```

After creating the program, specify the program to set the steps.

Specifying the aforementioned program

```
PROG "/BASIC/MY TEST"
```

When specifying a program in program memory, for tests other than an LC test, include "/SIGNAL IO/BASIC/" before the program name. For an LC test, include "/SIGNAL IO/LC/".

When specifying 51 (other than an LC test)

```
PROG "/SIGNAL IO/BASIC/51"
```

Set the number of steps of the specified program.

```
PROG:STEPS:COUN 2
```

Use this command also to change the number of steps. If the number is increased from the current number of steps, steps with default values are added after the last step. If the number is decreased, steps are deleted in order starting from the last step.

Next, set the steps.

Step 1: AC withstanding voltage test, test voltage 1500 V, current upper limit 10 mA, current lower limit 1 mA, test time 60 s, rest of the settings at default

Step 2: DC withstanding voltage test, test voltage 1800 V, current upper limit 1 mA, current lower limit 0.1 mA, test time 60 s, rest of the settings at default

```

PROG:STEP1:FUNC ACW
PROG:STEP1 1500
PROG:STEP1:JUDG:CURR 10MA
PROG:STEP1:JUDG:CURR:LOW 1MA
PROG:STEP1:JUDG:LOW:STAT ON
PROG:STEP1:TIM 60
PROG:STEP2:FUNC DCW
PROG:STEP2 1800
PROG:STEP2:JUDG:CURR 1MA
PROG:STEP2:JUDG:CURR:LOW 0.1MA
PROG:STEP2:JUDG:LOW:STAT ON
PROG:STEP2:TIM 60

```

For the following commands, CURRent, VOLTagE, or RESistance cannot be omitted when a unit is used in the parameter.

```

PROG:STEP1:SELEcted:STEP<n>:[CURRent:][LEVEl]
PROG:STEP1:SELEcted:STEP<n>:[CURRent:]SCALE:OFFSet:IMAGinary
PROG:STEP1:SELEcted:STEP<n>:[CURRent:]SCALE:OFFSet[:REAL]
PROG:STEP1:SELEcted:STEP<n>:JUDGment[:CURRent]:LOWer
PROG:STEP1:SELEcted:STEP<n>:JUDGment[:CURRent][:UPPer]
PROG:STEP1:SELEcted:STEP<n>:JUDGment[:VOLTagE]:LOWer
PROG:STEP1:SELEcted:STEP<n>:JUDGment[:VOLTagE][:UPPer]
PROG:STEP1:SELEcted:STEP<n>:[RESistance:]SCALE:OFFSet[:REAL]
PROG:STEP1:SELEcted:STEP<n>:[VOLTagE:][LEVEl]

```

Example when a unit is used

```
PROG:STEP1:JUDG:CURR 10MA
```

Example when a unit is not used

```
PROG:STEP1:JUDG 0.01
```

For details on step setting commands, see -> “PROG:STEP<n>:<prog_item>”(p. 124).

Next, set the program conditions.

Set the step interval time to 10 s.

```
PROG:INT:TIM 10
```

Set the operation to be executed when a fail judgment occurs.

To end the step in execution when a FAIL occurs, start the next step after the step interval elapses, and produce a FAIL judgment when all steps are completed

```
PROG:FAIL:CONT ON
```

To end the auto test when a FAIL occurs and produce a FAIL judgment

```
PROG:FAIL:CONT OFF
```

Save the program.

```
PROG:SAVE
```

You can start the auto test without saving the program, but the program will be erased if you turn off the POWER switch.

When you are done with the settings, start the auto test.

■ Starting an auto test

The TEST trigger subsystem has three states: IDLE, INITiated, and WTG.

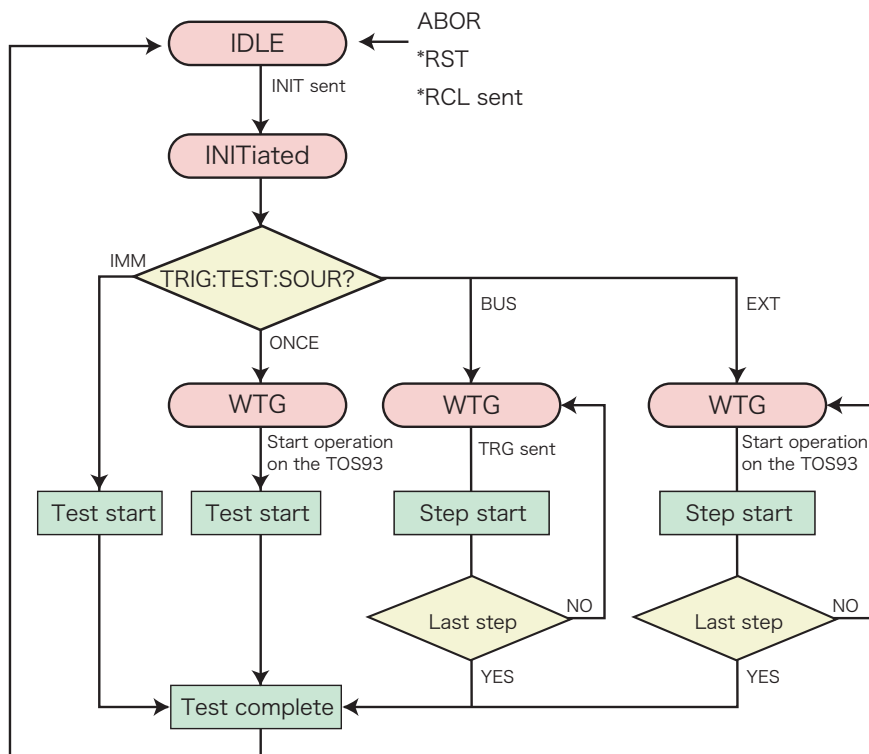

First, reset the TEST trigger subsystem.

```
ABOR:TEST
```

To start a sequence operation immediately, set the trigger source to IMM, and then use the INIT command.

```
TRIG:TEST:SOUR IMM
```

```
INIT:TEST
```

To start an auto test with a software trigger, change the trigger source to BUS

When you send INIT:TEST, the trigger subsystem switches to the WTG (Waiting For Trigger) state. When a software trigger is received through TRIG:TEST or *TRG, the test starts. When a step is completed, the product pauses and switches to the WTG (Waiting For Trigger) state. When a software trigger is received through TRIG:TEST or *TRG, the test resumes, and the next step starts.

```
TRIG:TEST:SOUR BUS
```

```
INIT:TEST
```

```
TRIG:TEST
```

TRIG:TEST applies a software trigger only to the TEST trigger subsystem.

You can also use the *TRG command or the IEEE488.1 get (Group Execute Trigger) command for the same purpose. This command applies a software trigger to all trigger subsystems, if there are other trigger subsystems in the initiated state, their trigger operations will also be executed at the same time.

To start an auto test from the TOS93, change the trigger source to EXT or ONCE.

With ONCE, when an auto test is started once on the TOS93, all steps are executed. With EXT, when a step is completed, the product pauses and switches to the WTG (Waiting For Trigger) state. When you start an auto test on the TOS93 again, the next step starts.

When you send INIT:TEST, the trigger subsystem switches to the WTG (Waiting For Trigger) state. The test starts when you perform a start operation on the unit.

```
TRIG:TEST:SOUR EXT
```

```
INIT:TEST
```

When the auto test finishes, the trigger subsystem returns to the IDLE state again. If the ABOR command or an equivalent command is received in the WTG state or when an auto test is being executed, the test is canceled, and the trigger subsystem returns to the IDLE state.

Querying measured values

Measurement value queries use the ACQ subsystem.

There are simple measurements, normal measurements, advanced measurements.

■ Simple measurement

This product has functions for returning the measured voltage, current, resistance, and elapsed test time. The easiest measurement method is using the MEAS command.

MEAS changes the TRIGger and SAMPlE subsystem settings to the values shown below, makes a new measurement, and then queries the measurement data.

Command	Value
TRIG:ACQ:SOUR	IMM
TRIG:ACQ:COUN	1
TRIG:ACQ:DEL	0.0
SAMP:TIM	0.0
SAMP:COUN	INF
SAMP:TEST:ENAB	ON

Because this query starts a new measurement each time that it is sent, you cannot use it to synchronize the measurement of multiple items. The measurement method explained in “Advanced measurement” allows you to separate the measurement start operation and the data query operation.

Voltage query

```
MEAS:VOLT?
```

Current query

```
MEAS:CURR?
```

Resistance query

```
MEAS:RES?
```

Elapsed test time query

```
MEAS:ETIM?
```

You can also query the items you have selected.

```
DATA:FORM CURR,VOLT,RES,ETIM
```

```
MEAS?
```

The items specified by DATA:FORM are returned in a sequence in response to MEAS?. You can specify up to eight parameters for DATA:FORM.

Normally, it takes approximately 200 ms for a single measurement to complete.

If you send the MEAS query multiple times, data acquisition will take a long time. If you want to acquire the data of multiple items, perform measurement in the method described in “Advanced measurement”, or specify the items you want to query by DATA:FORM and query them by using MEAS?.

■ Normal measurement (READ)

Because "measurement condition settings" and "starting measurements to acquire data" can be separately set in normal measurements, you can specify measurement conditions in detail. After setting measurement conditions, use READ? to start measurements.

Because this query starts a new measurement each time that it is sent, you cannot use it to synchronize the measurement of multiple items. The measurement method explained in "Advanced measurement" allows you to separate the measurement start operation and the data query operation.

You cannot make any changes to the test condition settings during measurement. You can only make changes to the settings after the measurement finishes or is aborted.

Set the current measurement mode to "Measures only the AC component with true rms value".

```
SENS:MET:CURR:MODE AC
```

Current query

```
READ:CURR?
```

You can also query the items you have selected.

```
DATA:FORM CURR,VOLT,RES,ETIM
```

```
READ?
```

The items specified by DATA:FORM are returned in a sequence in response to READ?. You can specify up to eight parameters for DATA:FORM.

Normally, it takes approximately 200 ms for a single measurement to complete.

If you send the READ query multiple times, data acquisition will take a long time.

If you want to acquire the data of multiple items, measure in the method described in "Advanced measurement", or specify the items you want to query by using DATA:FORM and query them by using READ?.

The difference between the MEAS command and the READ command is that the MEAS command starts new measurement after resetting the TRIG subsystem and SAMP subsystems to its default settings while the READ command starts new measurement with the current settings.

■ Advanced measurement

In advanced measurement, you can separate and control the starting of measurement and the referencing of data.

To start a new measurement, use the INIT command.

```
INIT:ACQ
```

When you send INIT:ACQ, measurement data already acquired is invalidated. When the measurement finishes, you can use the FETC query to retrieve the measured data.

```
FETC:VOLT?
```

```
FETC:CURR?
```

```
FETC:RES?
```

```
FETC:ETIM?
```

You can also query the items you have selected.

```
DATA:FORM CURR,VOLT,RES,ETIM
```

```
FETC?
```

The items specified by DATA:FORM are returned in a sequence in response to FETC?. You can specify up to eight parameters for DATA:FORM.

If you send a FETC command before the measurement is complete, correct measurement data will not be obtained.

By using the *OPC command, you can obtain correct measurement data.-> [“Waiting for Operation Complete”](#)(p. 405)

When waiting for the completion of a measurement of the ACQUIRE trigger subsystem

```
INIT:ACQ;*OPC
```

The ABOR command and IEEE488.1 sdc/dcl commands abort measurements that are in progress.

These commands do not invalidate measured data that has already been acquired. On the other hand, the *RST and *RCL common commands not only abort a measurement that is in progress but also invalidate the acquired measured data.

If you send *RST::FETC:VOLT?, an error will occur because there is no measured data that the FETC query can retrieve and there is no new measurement that is going to be performed.

The difference between the MEASURE (or READ) command and the FETC com-

mand is as follows. The MEAS command starts a new measurement and then queries the measured data. The FETC command queries the measured data without first starting a new measurement.

■ Multi-point measurement with specified trigger counts

This product allows you to perform measurement up to 100 times by only one action for starting measurement (MEAS?/READ?/INIT). You can specify the number of times you want to perform measurement by setting a value to the trigger count.

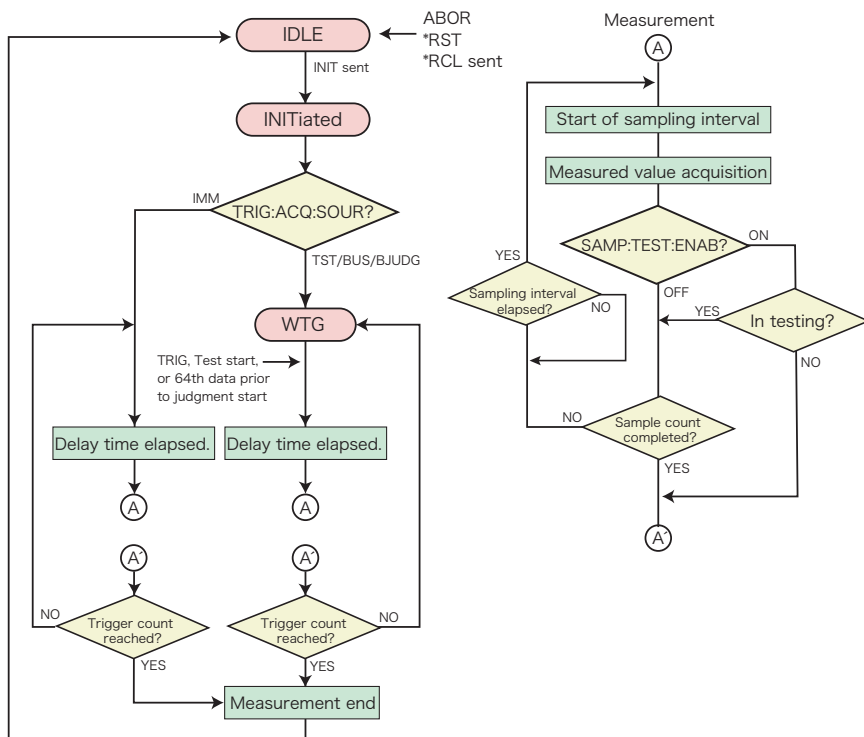

When starting measurement by MEAS?/READ?/INIT, this product successively repeats measurement for the number of times specified by the trigger count. When the measurement has finished, it becomes possible to acquire the measurement data. If you specify IMM (immediate) for the trigger source, the product will start measurement immediately after receiving MEAS?/READ?/INIT and automatically repeat measurement for the specified number of times. If you specify BUS for the trigger source, you need to send software triggers (* TRIG commands or IEEE488.1 get messages) for the number of times specified by the trigger count

after MEAS?/READ?/INIT. If you specify TIM for the trigger source, the product starts measurement when the time specified by TRIG:ACQ:DEL is elapsed since it has entered the state of INIT. You can specify the time in seconds and up to 100 s.

When performing measurement four times at intervals of one second,

```
TRIG:ACQ:COUN 4
TRIG:ACQ:DEL 1.0
TRIG:ACQ:SOUR IMM
INIT;*OPC?
```

Queries the measured value.

```
FETC:CURRE?;VOLT?
```

After the completion of measurement for the number of times specified by the trigger count, you can receive a response (ASCII character "1") to *OPC?. After this, you can acquire data by using FETC?.

If the measurement has not been completed yet because the INIT command or READ?/MEAS? just has been sent, the response data to FETC?/READ?/MEAS? is generated after the ongoing measurement is completed.

Querying test results

You can query test results.

The product holds the 1000 latest test results. The data is cleared when the power is turned off.

The items that can be queried are the test number, auto test step number, test mode, test start time (RFC2822 format), test start date (year), test start date (month), test start date (day), test start time (hour), test start time (minute), test start time (second), voltage at the time of judgment, current at the time of judgment, resistance at the time of judgment, test time at the time of judgment, and test result.

First specify the item you want to query using the parameters of the RES:FORM command (1 minimum, 25 maximum).

Value	Description	Value	Description
NUMBER	Test number	CIMaginary	Imaginary part of the current at the time of judgment
STEP	Auto test step number	RESistance	Resistance at the time of judgment
FUNCTION	Test mode	COULomb	Electric charge at the time of judgment
DATE	Test start time ^{*1}	PULSe:COUNT	Pulse count at the time of judgment
YEAR	Test start date (year)	IVOLTage	Discharge inception voltage
MONTH	Test start date (month)	EVOLTage	Discharge extinction voltage
DAY	Test start date (day)	PCURrent	Maximum current during a test
HOURL	Test start time (hour)	PRESistance	Minimum resistance during a test
MINute	Test start time (minute)	PCOULomb	Maximum electric charge during a test
SECOnd	Test start time (second)	ETIME	Test time at the time of judgment
VOLTage	Voltage at the time of judgment	JUDgment	Judgment result
CURRent	Current at the time of judgment	EJUDgment	Extended judgment result
CREal	Real part of the current at the time of judgment		

*1. RFC2822 format

The test number is incremented each time a test is performed. After 4294967295, the count returns to 0. After 2147483647, the count returns to 0.

When you select the extended judgment result, a detailed judgment result, including the scanner channels encountering an electrical continuity failure or the details of the protection function, in addition to an ordinary judgment result will be returned.

When querying the test mode, test start time, voltage, current, test time, and test

result

RES:FORM FUNC,DATE,VOLT,CURR,ETIM,JUDG

When you perform an auto test, we recommend that you also query the step number.

RES:FORM STEP,FUNC,DATE,VOLT,CURR,RES,ETIM,JUDG

When you are done setting the parameters, make a query.

There are two query commands. RES? queries the latest test result. This query does not delete the test result. RES:REM? queries the oldest test result. After the query, the result is deleted.

Item	Description	Response
Test number	--	NR1
Auto test step number	1 for a single test	NR1
Test mode	ACW	AC withstanding voltage
	DCW	DC withstanding voltage
	IR	Insulation resistance
	ECAC	Earth continuity (AC)
	ECDC	Earth continuity (DC)
	PD	Partial discharge
	TC-n ⁻¹	Touch current
	PCC-n ⁻¹	Protective conductor current
	PATIENT-n ⁻¹	Patient leakage current
Test start time	RFC2822 format	"string"
Test start date (year)	—	NR1
Test start date (month)		
Test start date (day)		
Test start time (hour)		
Test start time (minute)		
Test start time (second)		
Pulse count at the time of judgment		
Voltage at the time of judgment	—	NR3
Current at the time of judgment		
Real part of the current at the time of judgment		
Imaginary part of the current at the time of judgment		
Resistance at the time of judgment		
Test time at the time of judgment		
Test time at the time of judgment		

Item	Description		Response
Judgment result	PASS	PASS judgment.	character
Extended judgment result	U-FAIL	A value exceeding the upper limit was detected resulting in a FAIL judgment.	
	U-FAIL(dV/dt)	The voltage rise rate failed in a DC withstanding voltage test	
	L-FAIL	A value less than the lower limit was detected resulting in a FAIL judgment.	
	L-FAIL(dV/dt)	The voltage rise rate failed in an insulation resistance test	
	C-FAIL ^{*2}	An electrical continuity failed between scanner(s) and the EUT	
	C-FAIL(0xch ^{*3})		
	PROTECT ^{*2}	A protection function was activated, and the test was stopped.	
	PROTECT(factor ^{*4})		
ABORT	The test was aborted with a STOP signal.		

*1. n is the network name.

*2. Displayed only when JUDGment is selected by the RES:FORM command.

*3. This part is substituted by a value indicating a channel number in hexadecimal notation in the event of a failure in supplying power from the scanner to EUT in that channel. For details, see the 0xch channel information. The channel number is displayed only when EJUDgment is selected by the RES:FORM command.

*4. This part is substituted by a message indicating the generating factor of the activation of the protection function. For details, see the factor information. Displayed only when EJUDgment is selected by the RES:FORM command.

0xch channel information

If there is more than one channel encountering an electrical continuity failure, the channel numbers combined will be indicated.

0xCH	Channel	0xCH	Channel
0x0080	CH8(Scanner2-Ch4)	0x8000	CH16(Scanner4-Ch4)
0x0040	CH7(Scanner2-Ch3)	0x4000	CH15(Scanner4-Ch3)
0x0020	CH6(Scanner2-Ch2)	0x2000	CH14(Scanner4-Ch2)
0x0010	CH5(Scanner2-Ch1)	0x1000	CH13(Scanner4-Ch1)
0x0008	CH4(Scanner1-Ch4)	0x0800	CH12(Scanner3-Ch4)
0x0004	CH3(Scanner1-Ch3)	0x0400	CH11(Scanner3-Ch3)
0x0002	CH2(Scanner1-Ch2)	0x0200	CH10(Scanner3-Ch2)
0x0001	CH1(Scanner1-Ch1)	0x0100	CH9(Scanner3-Ch1)

factor information

If multiple factors have contributed to the activation of the protection function, the highest prioritized factor is returned.

factor	generating factor of the activation of the protection function		priority
ILOCK	Interlock	Interlock has been activated.	High ↑ ↓ Low
CAL	Calibration	The preset calibration period is exceeded.	
SIF	Scan I/F	While scanning, the interface cable is disconnected. The channel-assigned scanner is not detected.	
ORG	Over Range	A value exceeding the maximum value of the measurement range is detected.	
EF	Earth Fault	When the grounding mode is set to Guard, abnormal current flows from the high voltage output of this product to ground.	
RS	Relay Short	A relay operation error is detected in a leakage current test.	
PS	Power Supply	There is an error in the power supply section.	
MEAS	Measure	There is an error in the measurement check in a leakage current test.	
OUTERR	Output Error	An output voltage outside of the specified range is detected.	
OL	Over Load	An output power or current outside of the specified range is detected.	
OH	Over Heat	The internal temperature of the product is abnormally high.	
OR	Over Rating	During a withstanding voltage test, an output current is generated for a length of time that exceeds the output time limit.	
RMT	Remote	The REMOTE connector is connected or disconnected.	
SIO	Signal I/O	There is a change in the SIGNAL I/O connector's signals.	
COMM	Communication	An internal communication error is occurring. There has been no SCPI communication for a specified period of time or longer when the communication monitoring timer is used (SYST:COMM:PROT:WDOG ON).	

In a leakage current test, the network is returned along with the test mode.

RES?

If you want to check the test result in order from the first step, such as when you perform an auto test, use RES:REM?.

RES:REM?

<Reads the response>

RES:REM?

<Reads the response>

In this case, when you query the oldest test result with RES:REM?, the oldest test result is deleted, so when you query again with RES:REM?, the next test result is returned.

The test start time in RFC2822 format returns the day of the week (abbreviation), day, month (abbreviation), year, hour:minute:second, and time zone.

```
Wed, 24 Oct 2018 08:14:02 +0000
```

If you selected the extended judgment result, on October 23 and the test resulted in an electrical continuity failure between the scanners (CH1, CH2, and CH5) and an EUT, the response would be as follows:

```
C-FAIL(0x0013)
```

If a test terminated due to the activation of the interlock with the extended judgment result, selected, the response would be as follows:

```
PROTECT(ILOCK)
```

Waiting for Operation Complete

The *OPC command has a function for waiting for operations to complete. Operation complete means that there are no operations that are waiting for a response from the TOS93. Measurement completion requires about 200 ms. The TOS93 is not in the operation complete state while a measurement is ongoing. When the measurement completes, if there are no other operations waiting to be completed, the TOS93 enters the operation complete state

When an *OPC command is received, the product transitions to the Operation Complete Command Active State (OCAS). If a measurement is completed and there are no operations standing by, the product returns to the Operation Complete Command Idle State (OCIS) and sets the OPC bit (bit 0) of the event status register to TRUE (1). This information can be determined by checking the OPC bit (bit 0) of the *ESR? query.

Next, we will show an example that starts a new measurement and sends an *OPC command. Because the event status enable register and service request enable register are configured to generate a service request (SRQ) in response to an operation complete event, an SRQ is generated when a measurement is completed. The SRQ function cannot be used if you are using the RS232 interface

```
*ESE 1;*SRE 32;*CLS;:INITiate:IMMediate:ACQuire;*OPC
```

<Generates a service request>

If you use the *OPC? query command in place of the *OPC command, the product transitions to the Operation Complete Query Active State (OQAS). If a measurement is completed and there are no operations standing by, the product returns to the Operation Complete Query Idle State (OQIS) and sets response data "1" (in NR1 format) in the output queue.

```
INITiate:IMMediate:ACQuire;*OPC?
```

<Reads the response>

At power-on, if you send an IEEE488 sdc/dcl, *RST, or *RCL, this product switches to the OCIS and OQIS states.

Status Monitoring

The product has two mandatory SCPI standard registers, STATus:OPERation and STATus:QUEStionable, in addition to the IEEE488.2 standard registers.

■ Register basics

All SCPI registers have a standard architecture that uses events/filters. CONDition, EVENT, and ENABle and optionally PTRansition and NTRansition can be used. CONDition and EVENT are read-only registers working as status indicators. ENABle, PTRansition and NTRansition are read-write registers working as event and summary filters.

■ STATus:OPERation

The OPERation Status register is used to record events and notifications that occur during normal operations.

To check whether a test is in process, check the MEASuring bit (bit 4) of the STATus:OPERation register.

```
STATus:OPERation?
```

Alternatively, the MEASuring bit can be checked directly.

```
STAT:OPER:ABUS?
```

■ STATus:QUEStionable

The QUEStionable Status register is used to record events and notifications that occur during abnormal operations.

To check the voltage measurement for overrange, check the OV bit (bit 0) of the STATus:QUEStionable register.

```
STATus:QUEStionable?
```

■ PON (Power ON) bit

The PON bit (bit 7) of the event status register is always set when the product is turned on. To generate a power-on SRQ to track power failures and power supply line errors, use PON as follows.

1

Set *PSC (Power-on Status Clear) to 0 (or OFF).

Enable the backup functions for event status enable register and service request enable register settings. (*PSC 0)

2

Set the PON bit (bit 7) of the event status enable register.

This enables the transmission of power-on events to the higher layer. (*ESE 128)

3

Set the ESB bit (bit 5) of the status byte enable register.

This enables the generation of SRQs based on standard events. (*SRE 32)

*PSC 0; *ESE 128; *SRE 32

When you use the RS232C interface, the PON bit cannot be assigned to a service request because SRQs are not generated.

When you use the USB or LAN (VXI-11/HiSLIP) interface, even though the SRQ function itself is supported by the communication protocol, a connection lost error occurs in the VISA I/O session immediately before the power-on event. It appears that handling PON events would be difficult.

Error Checking

■ Error/event queue

The SCPI specifications define a standard error reporting scheme, Error/Event Queue. This is a FIFO (First In First Out) queue, which records errors and events. The maximum number of errors/events that the product can record is 16. Each error/event can be read with the `SYSTem:ERRor` query.

```
SYSTem:ERRor?
```

The response to this query contains a numeric part (error/event number) and a textual description, such as:

```
-222,"Data out of range"
```

The error/event queue becomes empty when the `*CLS` common command is sent, when the last item in the queue is read, and when the product is turned on. When the error/event queue is empty, the query returns the following:

```
0,"No error"
```

When using commands on a PLC (sequencer, controller)

These are notes for when using commands on a PLC (sequencer, controller).

- Append a delimiter (ASCII 0x0A) to each command.
- When using RS232C, match the protocol with the sequencer setting.
- Return values vary in length. Because exponential (NR3) queries are also available, processing using functions is necessary on the sequencer side.

Visual Basic 2017

■ Project settings

First, add the communication middleware (VISA library) to the project.

Click References on the Project menu to open the Reference Manager window.

On the navigation pane, click COM and then Type Libraries.

From the list in the center of the window, select “VISA COM *.* Type Library” (where *.* is the VISA library version number), and select the check box.

Click OK to close the dialog box.

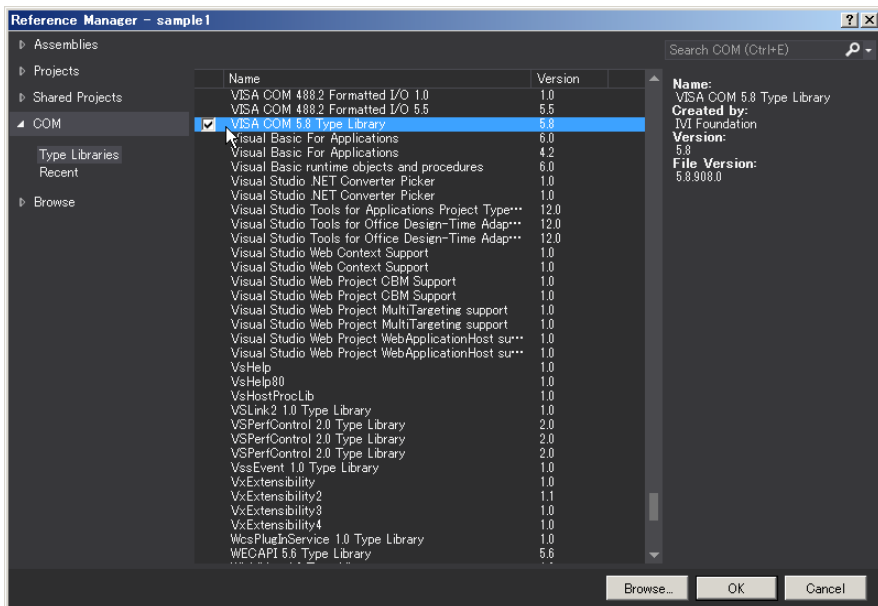

■ Communicating via RS232C, USB, LAN

Opening VISA

Before you can use the VISA library to communicate with RS232C, USB, and LAN devices, you have to open VISA. Specify an I/O resource to open VISA.

Example: Opening VISA when using USB on the TOS93

```
Set rm = CreateObject("VISA.GlobalRM")  
  
Set msg = rm.Open("USB::0x0B3E::0x104F::00000001::INSTR", NO_LOCK, 0, "")
```

“USB::0x0B3E::0x104F::00000001::INSTR” is an I/O resource.

The I/O resource syntax is shown below. The parts surrounded by square brackets ([]) can be omitted. Enter the appropriate values in the parts written in italics.

Serial (RS232C)		ASRL[<i>board</i>][:INSTR] Example: A measuring instrument connected to serial port COM1 ASRL1::INSTR
USB		USB[<i>board</i>]::VendorID::ProductID::SerialNumber[:InterfaceNumber][:INSTR] Example: A USBTMC measuring instrument whose vendor ID (VID) is 2878, product ID (PID) is 4175, and serial number is 00000001 USB0::0x0B3E::0x104F::00000001::INSTR
LAN ^{*1}	VXI-11	TCPIP[<i>board</i>]:: <i>hostname</i> [:inst0][:INSTR] Example: Measuring instrument whose IP address (hostname) is 169.254.7.8 TCPIP::169.254.7.8::INSTR You can also specify the host name for the hostname parameter.
	HiSLIP	TCPIP[<i>board</i>]:: <i>hostname</i> ::hislip0[:INSTR] Example: Measuring instrument whose IP address (hostname) is 169.254.7.8 TCPIP::169.254.7.8::hislip0::INSTR You can also specify the host name for the hostname parameter.
	SCPI-RAW	TCPIP[<i>board</i>]:: <i>hostname</i> :: <i>portno</i> ::SOCKET Example: Measuring instrument whose IP address (hostname) is 169.254.7.8 (the product's port number is fixed to 5025) TCPIP::169.254.7.8::5025::SOCKET You can also specify the host name for the hostname parameter.

*1: The hostname must be a valid mDNS hostname (a Bonjour hostname that ends in ".local") or a DNS hostname that is managed by an external DNS server (a full-qualified domain name—FQDN). If you are using an mDNS hostname, Apple Bonjour (alternatively, iTunes or Safari) must be installed on your PC.

In VISA, you can use aliases for I/O resources.

If you use an alias for an I/O resource, even if the alias name is hard-coded in the application, the I/O resource name can still be changed to an appropriate value when the application runs.

Example: Using an alias (MYDEV1) for an I/O resource

```
Set msg = rm.Open("MYDEV1", NO_LOCK, 0, "")
```

When you use aliases, specify the actual I/O resources through an external configuration table or similar tool. Refer to the VISA manual.

Controlling the instrument

Next, we will use commands such as read and write commands to control the instrument. You must include line-feed codes in the command strings.

Examples:

```
msg.WriteString ("FUNC MET" & vbCrLf)           'Set to meter mode
msg.WriteString ("SENS:MET:RANG:AUTO ON" & vbCrLf) 'Set to auto range
```

Closing VISA

Finally, close VISA.

In a sequence of operations, you only have to open and close VISA once.

```
msg.Close
```

■ Sample program

Imports Ivi.Visa.Interop

Public Class Form1

```
Dim rm As ResourceManager
```

```
Dim msg As IMessage
```

```
Sub Form1_Load(ByVal sender As System.Object, ByVal e As System.EventArgs) Handles MyBase.Load
```

```
    rm = CreateObject("VISA.GlobalRM")
```

```
    'Version using USB
```

```
    'msg = rm.Open("USB0::0x0B3E::0x104F::00000001::INSTR", AccessMode.NO_LOCK, 0, "")
```

```
    'Version using a VISA alias
```

```
    'msg = rm.Open("MYDEV1", AccessMode.NO_LOCK, 0, "")
```

```
    'Version using LAN (SCPI-RAW)
```

```
    msg = rm.Open("TCPIP::169.254.7.8::5025::SOCKET", AccessMode.NO_LOCK, 0, "")
```

```
    msg.TerminationCharacterEnabled = True
```

```
End Sub
```

```
'Query the ID
```

```
Private Sub Button1_Click(ByVal sender As System.Object, ByVal e As System.EventArgs) Handles Button1.Click
```

```
    msg.WriteString("SYST:COMM:RLST REM" & vbCrLf)
```

```
msg.WriteString("**IDN?" & vbCrLf)
TextBox1.Text = msg.ReadString(256)
```

End Sub

'Configure the AC withstanding voltage test

```
Private Sub Button2_Click(ByVal sender As System.Object, ByVal e As System.EventArgs) Handles Button2.Click
```

```
msg.WriteString("**RST" & vbCrLf)
msg.WriteString("FUNC ACW" & vbCrLf)
msg.WriteString("ACW:VOLT 1500" & vbCrLf)
msg.WriteString("SENS:JUDG 10MA" & vbCrLf)
msg.WriteString("ACW:VOLT:TIM 60" & vbCrLf)
```

End Sub

'Execute the test

```
Private Sub Button3_Click(ByVal sender As System.Object, ByVal e As System.EventArgs) Handles Button3.Click
```

```
msg.WriteString("TRIG:TEST:SOUR IMM" & vbCrLf)
msg.WriteString("INIT:TEST" & vbCrLf)
TextBox1.Text = msg.ReadString(256)
```

End Sub

```
Private Sub Form1_Disposed(ByVal sender As Object, ByVal e As System.EventArgs) Handles Me.Disposed
```

```
msg.Close()
```

End Sub

End Class

Appendix

List of Errors

■ Command errors

An error in the range [-199, -100] indicates that an IEEE 488.2 syntax error has been detected by the instrument's parser. The occurrence of any error in this class causes the Command Error bit (bit 5) in the event status register to be set.

Error code		Error message description
-100	Command error	Command error. Generic syntax error.
-101	Invalid character	An invalid character exists. A data element different than those allowed was recognized.
-102	Syntax error	Syntax error. An unrecognized command or data type was encountered.
-103	Invalid separator	Invalid separator The parser was expecting a separator and encountered an illegal character.
-104	Data type error	Data type error. The parser recognized a data element different than one allowed.
-105	GET not allowed	Get not allowed. A Group Execute Trigger was received in a program message.
-108	Parameter not allowed	Parameter not allowed More parameters were received than expected for the header.
-109	Missing parameter	Missing parameter Fewer parameters were received than required for the header.
-110	Command header error	Command header error. An error was detected in the header.
-112	Program mnemonic too long	Mnemonic too long. The number of characters in the command header exceeds 12 characters.
-113	Undefined header	Undefined header. Inappropriate for the product.
-114	Header suffix out of range	Invalid suffix exists in the header.
-115	Unexpected number of parameters	Unexpected parameters were received in the header.
-120	Numeric data error	Numeric data error. Generated when parsing a data element which appears to be numeric, including the nondecimal numeric types.
-128	Numeric data not allowed	Numeric data is not allowed.
-130	Suffix error	Suffix error. Generated when parsing a suffix.
-131	Invalid suffix	A suffix is invalid. The suffix does not follow the syntax, or the suffix is inappropriate for the product.
-134	Suffix too long	Suffix too long. The suffix contains too many characters.
-138	Suffix not allowed	A suffix was encountered after a numeric parameter that does not allow suffixes.
-140	Character data error	Character data error. Generated when parsing a character data element.
-141	Invalid character data	Either the character data element contains an invalid character, or the element is not valid.
-144	Character data too Long	Character data too long. The character data element contains too many characters.
-148	Character data not allowed	Character data is not allowed.
-150	String data error	String data error. Generated when parsing a string data element.

Error code	Error message description
-151	Invalid string data
-158	String data not allowed
-160	Block data error
-170	Expression error
-180	Macro error

■ Execution errors

An error in the range [-299, -200] indicates that an error has been detected by the instrument's execution control block. The occurrence of any error in this class causes the Execution Error bit (bit 4) in the event status register to be set.

Error code	Error message description
-200	Execution error (generic)
-203	Command protected
-210	Trigger error
-211	Trigger ignored
-213	Init ignored
-214	Trigger deadlock
-220	Parameter error
-221	Settings conflict
-222	Data out of range
-223	Too much data
-224	Illegal parameter value
-230	Data corrupt or stale
-241	Hardware missing

■ Product-specific errors

An error in the range [-399, -300] indicates that an error other than command error, query error, or execution error was detected. The occurrence of any error in this class causes the Device Dependent Error bit (bit 3) in the event status register to be set.

Error code	Error message description
-310	System error
-311	Memory error
-313	Calibration memory lost
-314	Save/recall memory lost
-315	Configuration memory lost
-330	Self-test failed
-350	Queue overflow

Error code	Error message description
-360	Communication error Communication error that occurs when flow control is off. This is an error when using RS232C.
-362	Framing error in program message Framing error. This is an error when using RS232C.
-363	Input buffer overrun Buffer overflow error. This is an error when using RS232C.
-365	Time out error Time out error. This is an error when using RS232C.

■ Query errors

An error in the range [-499, -400] indicates that the output queue control of the instrument has detected a problem with the message exchange protocol described in IEEE 488.2, chapter 6. The occurrence of any error in this class causes the Query Error bit (bit 2) in the event status register to be set.

Error code	Error message description
-400	Query error (generic) Query error. A generic product error.
-410	Query INTERRUPTED Received a new command after the query was received and before the response was read.
-420	Query UNTERMINATED The controller attempted to read the response after the device received an unsupported query or did not received a query. The "-100 COMMAND ERROR" and this error are stored in the error queue. The controller will time out.
-430	Query DEADLOCKED The error queue, input buffer, and output buffer are full when sending large binary data as a response, and the transmission timing is off.
-440	Query UNTERMINATED after indefinite response Received a separate query in semicolon-delimited format after a query that returns a response in an indefinite form. (Example: A compound command such as *IDN?;SYST:ERR?)

■ Operation complete event errors

An error in the range [-899, -800] is used when the product wants to report an IEEE 488.2 operation complete event. This event occurs when the instrument's synchronization protocol, having been enabled by an *OPC command, completes all selected pending operations.

The occurrence of any error in this class causes the Operation Complete bit (bit 0) in the event status register to be set.

Error code	Error message description
-800	Operation complete All selected pending operations in accordance with the IEEE 488.2, 12.5.2 synchronization protocol have completed.

■ Product-dependent errors

The occurrence of any error in this class causes the Device Dependent Error bit (bit 3) in the event status register to be set.

Configuration conflict errors and configuration change rejection errors

These errors occur when the specified configuration changes cannot be permitted.

Error code	
+101	Setting conflicts due to PROTECTION state
+102	Setting conflicts while TEST is running
+106	Setting conflicts due to invalid FUNCTION:MODE
+108	Wrong password given
+109	Illegal password format
+112	Setting conflicts while MEASURE is in progress
+113	Setting conflicts due to RISE state

Out of range setting errors

These errors occur when invalid or incorrect settings are specified.

Error code	
+201	Illegal buffers size due to not in 2 ^N
+202	Same items is specified more than once
+203	NONE is invalid in multiple item settings
+204	IMMEDIATE is invalid in multiple item settings
+205	BUS is invalid in multiple item settings

Auto test execution and trigger function execution errors

Error code	
+301	Illegal PROGRAM name
+302	PROGRAM name already exists
+303	PROGRAM not found
+304	PROGRAM not selected
+305	Selected PROGRAM cannot be deleted
+306	Recursive PROGRAM specified
+307	STEP number out of range
+308	Execution error due to non-existing PROGRAM specified
+309	Illegal PROGRAM file
+310	TRANSIENT not operating
+311	TRANSIENT not suspending

Command processing time

A certain amount of time is required before the commands shown in the following table are received by the product.

The processing times shown here are standard values, not guaranteed values.

The processing times vary depending on the settings and the measurement conditions

The values shown below do not include hardware response times

Command	USB processing time(ms)	RS232C ^{*1} processing time(ms)	LAN ^{*2} (VXI-11) processing time(ms)	LAN ^{*2} (HiSLIP) processing time(ms)
SOUR:FUNC:MODE	1.4	1.7	0.8	0.03
SOUR:VOLT	1.5	1.2	1.0	0.03
SOUR:VOLT:TIM	1.7	1.5	0.8	0.03
SENS:ACW:JUDG	1.5	1.6	0.8	0.03
MEAS:VOLT?	203	203	203	203
STAT:OPER:TEST:COND	2.7	3.5	2.5	1.4

*1: Baud rate setting: 115200 bps

*2: 100BASE-TX Ethernet

Legacy Commands

This product also runs on legacy commands used in the TOS9200 series. When creating a new program, use the new commands.

For details on the settings and responses of legacy commands, see the TOS9200 series GPIB/RS-232C interface operation manual.

Basic operation of legacy commands has been verified on the TOS9200 series, no guarantee is provided for complete operation of the TOS9200 series.

Legacy command	New command	Description
FUN	FUNC	Sets the test mode Only FUN is valid, not FUNCTION. Only parameters 0 to 3 are valid. Anything other than ACW, DCW, or IR returns -1.
Acw:TESTv	ACW:VOLT	Test voltage (ACW)
Acw:FREQuency	ACW:VOLT:FREQ	Test voltage frequency (ACW)
Acw:TIMer	ACW:VOLT:TIM ACW:VOLT:TIM:STAT	Test time (ACW)
Acw:RIseTIME	ACW:VOLT:SWE:TIM	Voltage rise time (ACW)
Acw:UPPer	SENS:ACW:JUDG	Upper limit judgment current (ACW)
Acw:LOWer	SENS:ACW:JUDG:LOW SENS:ACW:JUDG:LOW:STAT	Lower limit judgment current (ACW)
Dcw:TESTv	DCW:VOLT	Test voltage (DCW)
Dcw:TIMer	DCW:VOLT:TIM DCW:VOLT:TIM:STAT	Test time (DCW)
Dcw:RIseTIME	DCW:VOLT:SWE:TIM	Voltage rise time (DCW)
Dcw:UPPer	SENS:DCW:JUDG	Upper limit judgment current (DCW)
Dcw:LOWer	SENS:DCW:JUDG:LOW SENS:DCW:JUDG:LOW:STAT	Lower limit judgment current (DCW)
Ir:TESTv	IR:VOLT	Test voltage (IR)
Ir:TIMer	IR:VOLT:TIM IR:VOLT:TIM:STAT	Test time (IR)
Ir:RIseTIME	IR:VOLT:SWE:TIM	Voltage rise time (IR)
Ir:WaitTIME	SENS:IR:JUDG:DEL	Time until starting upper limit judgment (IR)
Ir:UPPer	SENS:IR:JUDG SENS:IR:JUDG:STAT	Upper limit judgment resistance (IR)
Ir:LOWer	SENS:IR:JUDG:LOW SENS:IR:JUDG:LOW:STAT	Lower limit judgment resistance (IR)
START	TRIG:TEST:SOUR IMM INIT:TEST	Starts a test
STOP	ABOR:TEST	Stops a test
LOCAL	SYST:COMM:RLST LOC	Switches to local mode
REMOte	SYST:COMM:RLST REM	Switches to remote mode

Legacy command	New command	Description
MeasMODE	なし	Sets the display mode for measured currents and resistances
MON?	MEAS?	Queries the measurement data
IDAT?	MEAS:CURR?	Queries the measured current
RDAT?	MEAS:RES?	Queries the measured resistance
DSR?	STAT:OPER:TEST:COND? STAT:OPER:COND?	Queries the content of the device status register

DSR? checks the OPER status register and the OPER:TEST status register of the TOS93 series and returns the content in terms of the device status register bits of the TOS9200 series.

KIKUSUI ELECTRONICS CORP.

1-1-3 Higashiyamata, Tsuzuki-ku, Yokohama,
224-0023, Japan

Tel: +81-45-482-6353

Fax: +81-45-482-6261

www.kikusui.co.jp/en

