

User's Manual

High voltage scanner
TOS93 series
TOS9320

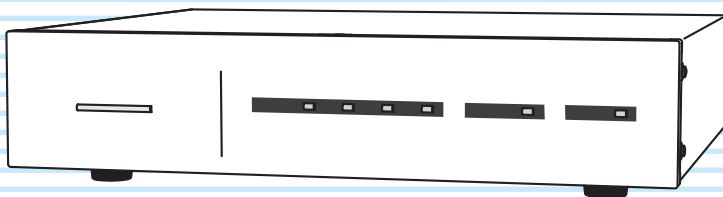

DANGER

**This product generates high voltage!
Improper operation can lead to serious accidents.**

To prevent accidents, be sure to read the section
“Safety Precautions for Testing” in this manual.
Keep this manual close to the product so that the operators
can read the manual at any time.

Contents **6**

Component Names **7**

Safety Precautions for Testing **9**

Preparation **13**

External Control **26**

Maintenance **30**

Specifications **31**

Appendix **35**

Notes to the Supervisor

- If the operators cannot understand the language used in this manual, translate the manuals into the appropriate language.
- Make sure that the operators understand the information in this manual before they operate this product.
- Keep this manual close to the product so that the operators can read the manual at any time.

DANGER

You will receive a potentially fatal electric shock if:

- You touch an output terminal while output is being generated.
- You touch a test lead that is connected to an output terminal while output is being generated.
- You touch the EUT while output is being generated.
- You touch a location that is electrically connected to an output terminal while output is being generated.
- You touch a location that is electrically connected to an output terminal immediately after output is turned off after a DC withstanding voltage test or insulation resistance test has been performed.

About Manuals

This manual provides an overview of the product and notes on usage. It also explains how to configure it, operate it, perform maintenance on it, and so on. Read this manual thoroughly before use, and use the product properly.

Intended readers

These manuals are intended for users of this product and their instructors. The manuals assume that the reader has knowledge about electric safety testing.

Manual construction

- User's manual  (this manual)

This document is intended for first-time users of this product. It provides an overview of the product, notes on usage, and specifications. It also explains how to connect the product, operate the product, perform maintenance on the product, and so on.

- Safety information 

This document contains general safety precautions. Keep them in mind and make sure to observe them.

Trademarks

All company names and product names used in this manual are trademarks or registered trademarks of their respective companies.

Copyright

Reproduction and reprinting of this operation manual, whole or partially, without our permission is prohibited.

Both unit specifications and manual contents are subject to change without notice.

Copyright© 2018 Kikusui Electronics Corporation

Disposal

Dispose of the product in accordance with your local regulations.

Checking the Package Contents

Check that all accessories are included and that the unit and accessories have not been damaged during transportation.

If any of the unit and accessories are damaged or missing, contact your Kikusui agent or distributor.

We recommend that you keep all packing materials, in case the product needs to be transported at a later date.

Accessories

The attached power cord varies depending on the shipment destination.

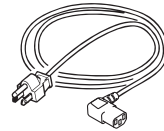

Plug: NEMA5-15
Rating: 125 Vac/10 A
[85-AA-0003]

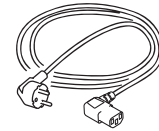

Plug: CEE7/7
Rating: 250 Vac/10 A
[85-10-1070]



Plug: GB1002
Rating: 250 Vac/10 A
[85-10-0791]

- Power cord (1 pc., length: 2.5 m)

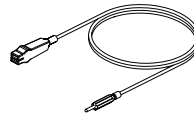

- High-voltage test lead [TL31-TOS] (8 red)

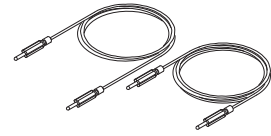

- Lead for high voltage parallel connection TL33-TOS (1 pair)

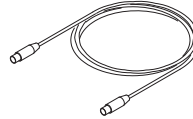

- Interface cable (1 pc.)

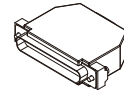

- CONTROLLER INTERFACE plug (1 set)
Assembly type
[D-sub plug unit]



- High-voltage warning sticker (2 pc.)



- Channel labels
For the panel (1 sheet)
For the test leads (1 sheet)

- User's manual (1 copy)

- China RoHS sheet (1 sheet)

- Safety Information (1 copy)

NOTE

Affix the high-voltage warning stickers in locations that are easily visible on the product or around the installation location.

Product Overview

The TOS9320 High Voltage Scanner is an option for the TOS93 Series Electrical Safety Analyzer. It is equipped with a function for distributing the test voltage supplied from the tester to multiple test points in withstanding voltage tests and insulation resistance tests.

The CONTROLLER INTERFACE connector on the rear panel can be used to control channels from an external device. When combined with an external controller, output from Kikusui TOS5300 series withstanding voltage and insulation resistance tester and the like can also be distributed.

The TOS9320 scanner adds the following functions to the tester.

- A single TOS9320 scanner expands an output to four channels. Each channel can be set to an electric potential of your choice (high, low, or open), and withstanding voltage tests or insulation resistance tests can be performed on any of the four test points.
- Up to four TOS9320 scanners can be connected to a single TOS93. When four scanners are connected, the output can be expanded up to 16 channels.
- The output of each channel and the contact between each test point can be verified.

These functions save power when testing electric/electronic devices and components that have multiple test points and enable highly reliable withstanding voltage and insulation resistance tests.

Notations Used in This Manual

- The TOS9320 High Voltage Scanner is also referred to as the TOS9320 scanner.
- The TOS9300, TOS9301, TOS9302, TOS9303, and TOS9303LC electrical safety analyzers are also referred to as the TOS93 series or TOS93 series testers.
- A tester connected to this product is also simply referred to as the tester.
- The term “PC” is used to refer generally to both personal computers and workstations.
- The term “EUT” is used to refer generally to an equipment under test.
- The following markings are used in this manual.

DANGER

Indicates an imminently hazardous situation which, if ignored, will result in death or serious injury.

WARNING

Indicates a potentially hazardous situation which, if ignored, could result in death or serious injury.

CAUTION

Indicates a potentially hazardous situation which, if ignored, may result in slight injury or damage to the product or other property.

NOTE

Indicates information that you should know.

Safety Precautions

When using this product, be sure to observe the precautions in the Safety Information manual. Items specific to this product are given below.

DANGER

- **You will receive a potentially fatal electric shock if:**
 - You touch an output terminal while output is being generated.
 - You touch a test lead that is connected to an output terminal while output is being generated.
 - You touch the EUT while output is being generated.
 - You touch a location that is electrically connected to an output terminal while output is being generated.
 - You touch a location that is electrically connected to an output terminal immediately after output is turned off after a DC withstanding voltage test or insulation resistance test has been performed.

WARNING

- **You may receive a potentially fatal electric shock if:**
 - You operate the tester without grounding it.
 - You operate the tester without using rubber gloves for electrical work.
 - You come close to a location that is electrically connected to an output terminal while output is being generated.
 - You come close a location that is electrically connected to an output terminal immediately after output is turned off after a DC withstanding voltage test or insulation resistance test has been performed.
- **Do not touch the tip of the test lead with your hand.**
Risk of electric shock.

CAUTION

- **Do not use this product near highly sensitive measuring instruments or receivers.**
Noise generated by this product may affect other devices. At a test voltage of 3 kV or greater, the product may produce corona discharge between its test lead clips. This will generate a significant amount of broadband RF emission. To minimize this effect, keep the alligator clips away from each other. Also, keep the alligator clips and test leads away from conducting surfaces, especially sharp metal edges.
- **Do not exceed the stacking limit.**
Stack only a single TOS9320 scanner on top of a TOS93 series tester. Otherwise, it may cause injury to the operator or damage to the product when it falls down.
If you are using multiple TOS9320 scanners, rack mount them, or install them next to the tester. When stacking scanners, do not stack more than two scanners.
- **This equipment is not intended for use in residential environments and may not provide adequate protection to radio reception in such environments.**

Notes on Usage

- When installing this product, be sure to observe the temperature and humidity ranges indicated below.
Operating temperature range: 0 °C to 40 °C (32 °F to 104 °F)
Operating humidity range: 20 %rh to 80 %rh (no condensation)
- When storing this product, be sure to observe the temperature and humidity ranges indicated below.
Storage temperature range: -20 °C to 70 °C (-4 °F to 158 °F)
Storage humidity range: 90 %rh or less (no condensation)

Contents

About Manuals.....	3
Checking the Package Contents	3
Product Overview	4
Notations Used in This Manual.....	4
Safety Precautions	5
Notes on Usage.....	5
Component Names.....	7

Safety Precautions for Testing

Lighting of the DANGER LED.....	9
Test Precautions.....	9
Pre-test precautions	9
Testing precautions.....	10
Precautions when changing test conditions.....	10
Precautions after Output Has Been Turned Off	11
Malfunction Precautions	12
Dangerous malfunctions	12
Emergency measures.....	12

Preparation

Connecting the Power Cord	13
Checking Whether the Power Is On or Off	14
Turning the power on	14
Turning the power off	14
Connecting to a TOS93 Series Tester.....	15
Before connecting	15
Connecting to a TOS93 series tester.....	17
Connecting TOS9320 Scanners to the EUT....	19
Before connecting	19
Connecting the EUT.....	24
Disconnecting test leads from the EUT.....	25

External Control

Turning External Control On and Off.....	26
CONTROLLER INTERFACE Connector	27
Pin arrangement	27
I/O signal circuit.....	28
Input signal usage example.....	28
Output signal usage example	29

Connecting to the CONTROLLER INTERFACE connector	29
--	----

Maintenance

Pre-Test Inspection	30
Cleaning the Panels	30

Specifications

Basic specifications.....	31
Interface and other functions.....	32
General specifications	33
External dimensions.....	34

Appendix

Timing Charts (Contact check operation).....	35
Rack mounting (option)	36
Troubleshooting.....	37
Index.....	38

Component Names

Front panel

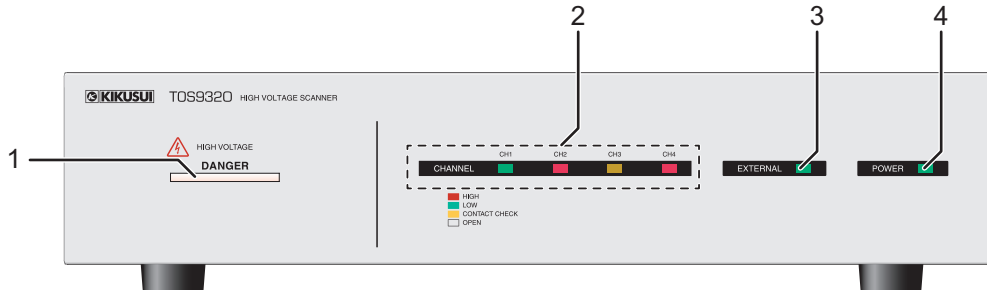

No.	Name	Function	See
1	DANGER LED	Lights in sync with the TOS93 series tester when the power is turned on, when a test is in progress, when a high voltage is being output, or when there is residual voltage at the output terminals.	p. 9
2	CHANNEL CH1/CH2/CH3/CH4 LED	Displays with different colors the status of each channel when a test is in progress. <ul style="list-style-type: none">• Red: Set to high.• Green: Set to low.• Orange: Contact being checked.• Off: Set to open.	–
3	EXTERNAL LED	Lights green when external control is enabled (EXTERNAL I/O is on).	p. 26
4	POWER LED	Lights green when the POWER switch is on.	p. 14

Rear panel

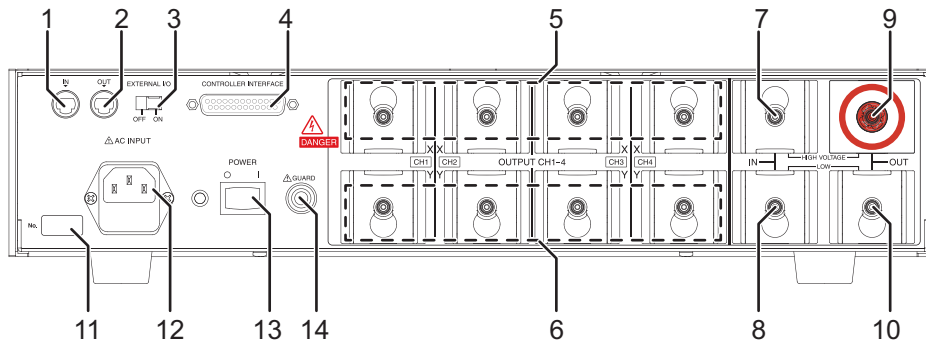

No.	Name	Function	See
1	IN connector	A connector for connecting to a TOS93 series tester. When connecting several TOS9320 scanners in parallel, connect this to another TOS9320 scanner.	p. 17
2	OUT connector	When connecting several TOS9320 scanners in parallel, connect this to another TOS9320 scanner.	p. 17
3	EXTERNAL I/O switch	Turns external control on and off.	p. 26
4	CONTROLLER INTERFACE connector	A I/O signal connector for controlling this product from an external device.	p. 27
5	OUTPUT CH1-4 X terminals	High voltage terminals of each channel. Each channel can be set to an electric potential of your choice (high, low, or open) from the TOS93 series tester.	p. 19
6	OUTPUT CH1-4 Y terminals	Low voltage terminals of each channel. Each channel can be set to an electric potential of your choice (high, low, or open) from the TOS93 series tester.	p. 19
7	IN HIGH VOLTAGE terminal	A terminal for connecting this product to a TOS93 series tester or to another TOS9320 scanner connected in parallel in order to receive the test voltage from the TOS93 series tester. The test voltage is supplied at all times during a test.	p. 17
8	IN LOW terminal	A terminal for connecting to a TOS93 series tester or another TOS9320 scanner connected in parallel.	p. 17
9	OUT HIGH VOLTAGE terminal	A terminal for supplying the test voltage received from the tester to another TOS9320 scanner when several TOS9320 scanners are connected in parallel. The test voltage is supplied at all times during a test. Do not connect this terminal to the EUT.	p. 17
10	OUT LOW terminal	A terminal for connecting to another TOS9320 scanner when several TOS9320 scanners are connected in parallel.	p. 17
11	Serial number	Serial number.	—
12	AC INPUT inlet	The power cord inlet for supplying power to this product.	p. 13
13	POWER switch	The power switch of this product.	p. 14
14	GUARD terminal	A terminal for connecting a chassis connection wire when a shield box is used.	p. 23

Safety Precautions for Testing

Lighting of the DANGER LED

The DANGER LED lights when the TOS9320 scanner is in any of the following conditions.

- At power on
- When a test is running
- When high voltage is being output
- When voltage remains at the output terminals

Check whether the DANGER LED lights at power on. If it does not, stop using the TOS9320 scanner, and contact your Kikusui agent or distributor.

Test Precautions

Pre-test precautions



WARNING

Risk of electric shock. The TOS9320 scanner supplies the 5.0 kVac, 7.2 kVdc, or higher voltage received from the TOS93 series tester to external devices. Handling the product improperly may lead to a fatal accident. To prevent accidents, strictly follow the precautions and always pay the utmost attention to safety concerns when you operate the product.

Check the following items before you start testing, and always follow the precautions.

- **The power cord is connected to a properly grounded outlet.**
- **There is no damage such as tears or breaks in the test lead insulation.**
- **When the POWER switch is turned on, the DANGER LED lights.**
- **While the DANGER LED is lit, do not touch the items that are charged to a high voltage: the EUT, the test leads, and the areas near the output terminals.**
- **When the DANGER LED is lit, do not turn the POWER switch off except in an emergency.**

Testing precautions

WARNING

Risk of electric shock.

- While the DANGER LED is lit, it is dangerous to touch the items that are charged to a high voltage: the EUT, the test leads, the probes, and the areas near the output terminals.
- Parts of the included test leads near the alligator clips protrude from the vinyl insulation when the wires are connected. These parts are dangerous. Never come close to these parts while the DANGER LED is lit.
- During use, be sure to wear rubber gloves for electrical work. If obtaining these gloves is difficult, contact your Kikusui agent or distributor.

During testing, the DANGER LED lights. Be careful because high voltage may be being output when the DANGER LED is lit.

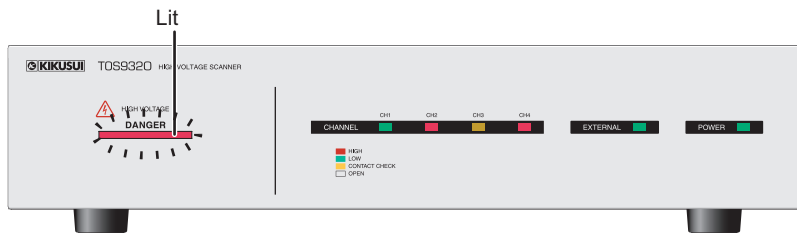

Precautions when changing test conditions

Before changing test conditions, press STOP on the tester and check that the DANGER LED is turned off to ensure safety.

Precautions after Output Has Been Turned Off

 **WARNING**

Risk of electric shock.

- **For a while after the output has been turned off, do not touch the items that have been charged to a high voltage, such as the EUT, the test leads, the test probes, and the areas near the output terminals.**
 - **After the output has been turned off, the TOS93 series tester's internal discharge circuit goes into operation and discharges the output voltage. During testing and before this discharge completes, do not disconnect the tester from the EUT.**
-

During DC withstanding voltage tests and insulation resistance tests, the EUT, test leads, test probes, and the area around the output terminals are all charged to a high voltage. After the output has been turned off, be sure to check the following before you touch the items that have been charged to a high voltage.

- **The tester's DANGER LED is off.**
- **"RISE," "TEST," or "FALL" is not shown on the display.**

If you will not use the product for some time or if the operator will be away from the product, be sure to turn the tester's POWER switch off.

Malfunction Precautions



WARNING

Risk of electric shock.

- **Until you get the product fixed, make sure that nobody can use it.**
- **For repairs, contact your Kikusui agent or distributor.**

Dangerous malfunctions

If the product is in one of the states explained below, it may be malfunctioning in a very dangerous manner—it may not be possible to turn off the high voltage that is being generated.

- **Even when you press the tester's STOP switch, the DANGER LED remains lit.**
- **Even though a voltage is indicated on the tester's voltmeter, the DANGER LED does not light.**

If the tester is not operating properly, it may be generating a high voltage irrespective of the settings made by the operator. Immediately turn off the tester's POWER switch, and disconnect the power cord from the outlet. Further, turn off the TOS9320 scanners' POWER switches, disconnect the power cords, stop using the system immediately, and contact your Kikusui agent or distributor.

Emergency measures

There are two actions that you must carry out if, due to a malfunction in the test system or the EUT, there is a possibility of an emergency occurring such as electric shock or damage to the EUT.

- **Turn off the tester's POWER switch.**
- **Remove the tester's power cord plug from the outlet.**

Then, turn off the TOS9320 scanners' POWER switches, and disconnect the power cords from the outlet.

Preparation

This chapter describes how to prepare this product for use.

- For information about installing and moving this product, see "Precautions Concerning Installation Location" and "Precautions to Be Taken When Moving the Product" in the Safety information manual.
- When using or storing this product, be sure to observe the temperature and humidity ranges. For environmental conditions, see General Specifications (p. 33).
- If you want to mount the product on a rack, see "Rack mounting" (p. 36).

Connecting the Power Cord

WARNING

Risk of electric shock.

- **This product is IEC Safety Class I equipment (equipment with a protective conductor terminal). To prevent electric shock, be sure to connect the protective conductor terminal of the product to electrical ground (safety ground).**
- **The product is grounded through the power cord ground wire. Connect the protective conductor terminal to earth ground.**

NOTE

- Use the supplied power cord to connect to the AC line.
If the supplied power cord cannot be used because the rated voltage or the plug shape is incompatible, have a qualified engineer replace it with an appropriate power cord that is 3 m or less in length. If obtaining a power cord is difficult, contact your Kikusui agent or distributor.
- Do not use the supplied power cord with other instruments.
- The power cord with a plug can be used to disconnect the product from the AC power line in an emergency.
- Secure adequate space around the power plug. Do not insert the power plug to an outlet where accessibility to the plug is poor. And, do not place objects near the outlet that would result in poor accessibility to the plug.

This product is designed as an equipment of IEC Overvoltage Category II (energy-consuming equipment supplied from a fixed installation).

- 1 Turn the POWER switch off (O).**
- 2 Check that the AC power line meets the nominal input rating of the TOS9320 scanner.**
The product can receive a nominal line voltage in the range of 100 Vac to 240 Vac at 50 Hz or 60 Hz. (Frequency range: 47 Hz to 63 Hz)
- 3 Connect the power cord to the AC INPUT inlet on the rear panel.**
- 4 Connect the power cord plug to an outlet with a ground terminal.**
This completes the connections.

Checking Whether the Power Is On or Off

Follow the procedure below when turning on or off each device in a system in which a TOS9320 scanner is connected.

Turning the power on

- 1 Turn on (|) the **POWER** switch on the tester.

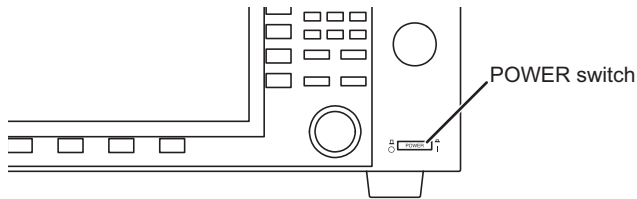

- 2 Turn on (|) the **POWER** switch on the TOS9320 scanner.

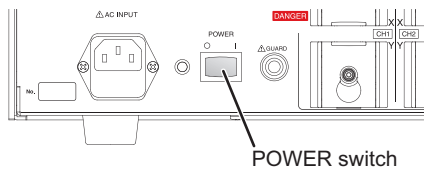

When the system is controlled from an external device through the **CONTROLLER INTERFACE**, turn on the external device last.

Turning the power off

When the system is controlled from an external device through the **CONTROLLER INTERFACE**, turn off the external device first.

- 1 Turn off (○) the **POWER** switch on the TOS9320 scanner.
- 2 Turn off (○) the **POWER** switch on the tester.

WARNING

Risk of electric shock.

- If you want to turn the **POWER** switch back on, wait at least 10 seconds. The protective functions of the product may not work effectively if you do not do so. This may cause the product to malfunction, and it may reduce the life of the **POWER** switch and internal parts such as the fuses.
- Except in an emergency, do not turn the **POWER** switch off while output is being generated.

Connecting to a TOS93 Series Tester

This chapter explains how to connect a TOS9320 scanner to a TOS93 series tester.

For details on how to configure the output and other settings of the TOS9320 scanner after making the connections, read the TOS93 series tester user's manual.

⚠ WARNING Risk of electric shock. While the DANGER LED is lit, never touch the HIGH VOLTAGE terminal, test leads, or EUT.

Before connecting

⚠ WARNING

Risk of electric shock.

- Parts of the included test leads near the alligator clips protrude from the vinyl insulation when the wires are connected. These parts are dangerous. Never come close to these parts while the DANGER LED is lit.
- If connections are incomplete, the entire EUT may be charged to a high voltage. This is dangerous, so be sure to connect the EUT correctly.

Never touch these while the DANGER LED is lit.

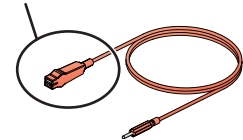

Number of connections

Up to four TOS9320 scanners can be connected to a TOS93 series tester.

The TOS9320 scanner is an option for the TOS93 series tester. By using the CONTROLLER INTERFACE connector, you can control channels from an external device in combination with a Kikusui TOS5300 series withstanding voltage and insulation resistance tester or the like (p. 26).

⚠ CAUTION

Stack only a single TOS9320 scanner on top of a TOS93 series tester. Otherwise, it may cause injury to the operator or damage to the product when it falls down.

If you are using multiple TOS9320 scanners, rack mount them. When stacking scanners, do not stack more than two scanners.

Channel number mapping

The TOS93 series tester assigns channel numbers to the TOS9320 scanners in order with the closest scanner first (for example, the tester assigns channels 1 to 4 to the TOS9320 scanner that it is directly connected to).

The following table shows the mapping of the channel numbers as seen from the TOS93 series tester and the channel numbers of each scanner.

Channels of each scanner		Channels as seen from the tester	Channels of each scanner		Channels as seen from the tester
1st scanner	CH1	CH1	3rd scanner	CH1	CH9
	CH2	CH2		CH2	CH10
	CH3	CH3		CH3	CH11
	CH4	CH4		CH4	CH12
2nd scanner	CH1	CH5	4th scanner	CH1	CH13
	CH2	CH6		CH2	CH14
	CH3	CH7		CH3	CH15
	CH4	CH8		CH4	CH16

NOTE

When you connect multiple TOS9320 scanners, affix the supplied channel labels to the scanner panels for easy identification.

Connecting to a TOS93 series tester

As an example, this section provides the connection diagram and procedure for connecting three TOS9320 scanners to a TOS93 series tester.



Risk of electric shock. Connect the cables securely. If cable connections are incomplete, the scanner chassis or the entire EUT may be charged to a high voltage.

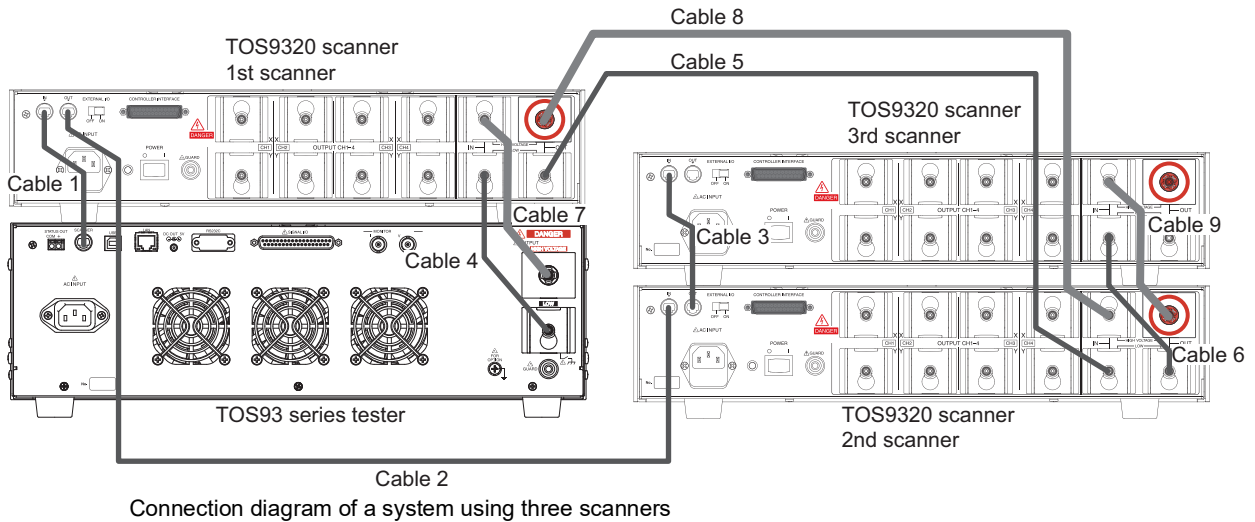

Cable No.	Supplied cable name	TOS93 series tester	TOS9320 1st scanner	TOS9320 2nd scanner	TOS9320 3rd scanner
Cable 1	Interface cable	SCANNER connector	→ IN terminal	-	-
Cable 2	interface cable	-	OUT terminal	→ IN terminal	-
Cable 3	interface cable	-	-	OUT terminal	→ IN terminal
Cable 4	Lead for high voltage parallel connection	OUTPUT LOW terminal	→ IN LOW terminal	-	-
Cable 5	Lead for high voltage parallel connection	-	OUT LOW terminal	→ IN LOW terminal	-
Cable 6	Lead for high voltage parallel connection	-	-	OUT LOW terminal	→ IN LOW terminal
Cable 7	Lead for high voltage parallel connection	OUTPUT HIGH VOLTAGE terminal	→ IN HIGH VOLTAGE terminal	-	-
Cable 8	Lead for high voltage parallel connection	-	OUT HIGH VOLTAGE terminal	→ IN HIGH VOLTAGE terminal	-
Cable 9	Lead for high voltage parallel connection	-	-	OUT HIGH VOLTAGE terminal	→ IN HIGH VOLTAGE terminal

NOTE

- When connecting four TOS9320 scanners, connect the third and fourth scanners in the same manner as connecting the first and the second and connecting the second and the third as shown in “Connection diagram of a system using three scanners” (p. 17).
- If you remove or insert an interface cable while the POWER switch on the TOS93 series tester is on, the tester’s protection function is activated. The display will show the word “SCANNER.” To release the protection, press STOP.

- 1 Turn off the POWER switch on the tester.**
- 2 Check that the cables are not broken and that their insulation is not damaged.**
- 3 Connect Cable 1 to Cable 3 (interface cables).**
Make sure the IN and OUT terminal connections are correct.

- 4 Connect the low side using Cable 4 to Cable 6 (leads for high voltage parallel connection).**
Each terminal has a cable lock to prevent the cable from coming loose. Secure the lead firmly with the cable lock.

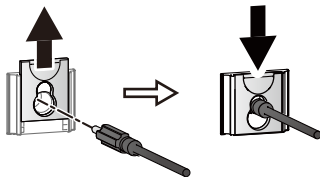

Be sure to complete all the low side connections first. Then connect the high voltage side.

- 5 Connect the high voltage side using Cable 7 to Cable 9 (leads for high voltage parallel connection).**
Each IN HIGH VOLTAGE terminal has a cable lock to prevent the cable from coming loose. Secure the lead firmly with the cable lock.

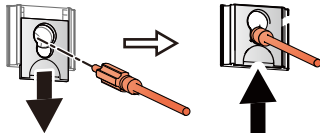

- 6 Check the connection of each cable one more time.**
Also ensure that the product is grounded.

Connecting TOS9320 Scanners to the EUT

Before connecting

This chapter explains information that you should be familiar with before connecting the TOS9320 scanner to the EUT.

TOS9320 scanner operation



WARNING

Risk of electric shock.

- Handle the Y terminals (low voltage side) and X terminals (high voltage side) the same way. Because the Y terminal test leads are connected to the X terminal test leads at the test points, high voltages are applied to the areas before the relays of the Y terminals during a test.
- If there is a possibility that the EUT or tools and the like will be grounded, do not set tester's GND to GUARD. If you select GUARD, do not connect measuring instruments that are grounded at one end (e.g., Kikusui 149-10A High Voltage Digital Voltmeter, TOS1200 Current Calibrator) to the TOS9320 scanner. Doing so is extremely dangerous because the ammeter will be shorted and will not be able to measure current. For details, see the TOS93 series tester user's manual.

"4 channel test system" (p. 20) shows an example in which all four channel outputs of a TOS9320 scanner are connected to the EUT test points. As can be seen from the figure, the X terminal of each channel output (OUTPUT CH1-4) becomes a high voltage terminal, and the Y terminal becomes a low terminal.

Each channel can be set to an electric potential of your choice (high, low, or open) from the TOS93 series tester.

During a test, the X terminal of channels set to high will output a high voltage. The Y terminal of channels set to low will be set to the low voltage potential. All other terminals will be open (not connected to anything).

For channels set to high or low, a high voltage is applied even to the Y terminals (low voltage side), so they need to be handled in the same manner as X terminals.

You can perform an AC/DC withstanding voltage test or insulation resistance test on any of the four test points, A to D. For example, if you set CH1 (test point A) to high, CH2 (test point B) to open, and CH3 (test point C) and CH4 (test point D) to low, relays RL 1x, RL 3y, and RL 4y in the TOS9320 scanner will be turned on.

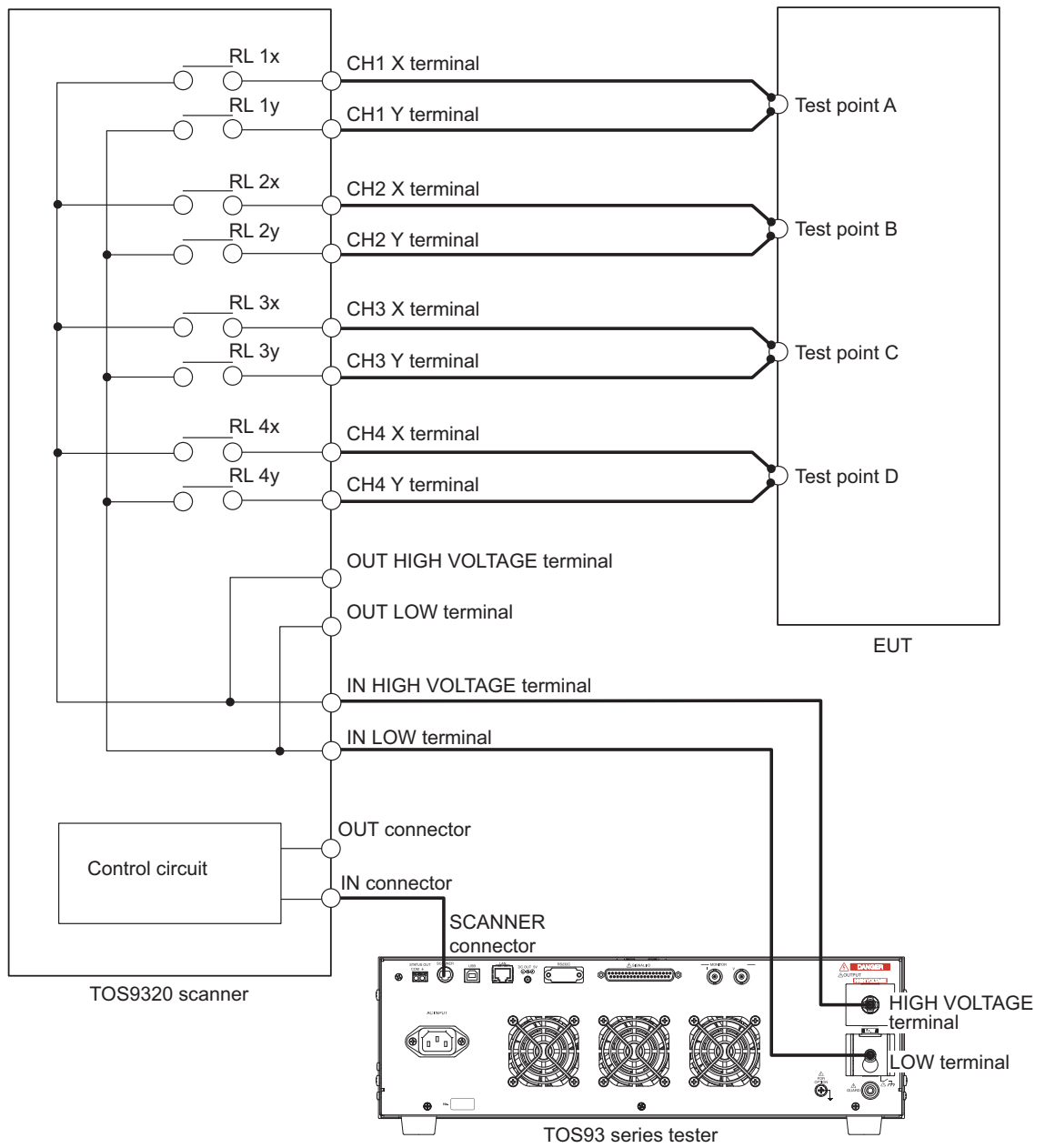

4 channel test system

Contact check operation

Contact check is a function for verifying that test leads are connected from the X and Y terminals of each channel to the test points on the EUT, that test leads are not broken, that there are no poor contacts, that internal relays are not broken, and so on.

If you turn on the contact check function and press START on the TOS93 series tester, a contact check is performed before starting the test. The TOS93 series tester checks the continuity between the test leads and the EUT by turning on both relays x and y in the TOS9320 scanner for channels set to high or low, applying about 2 Vdc, and measuring the current.

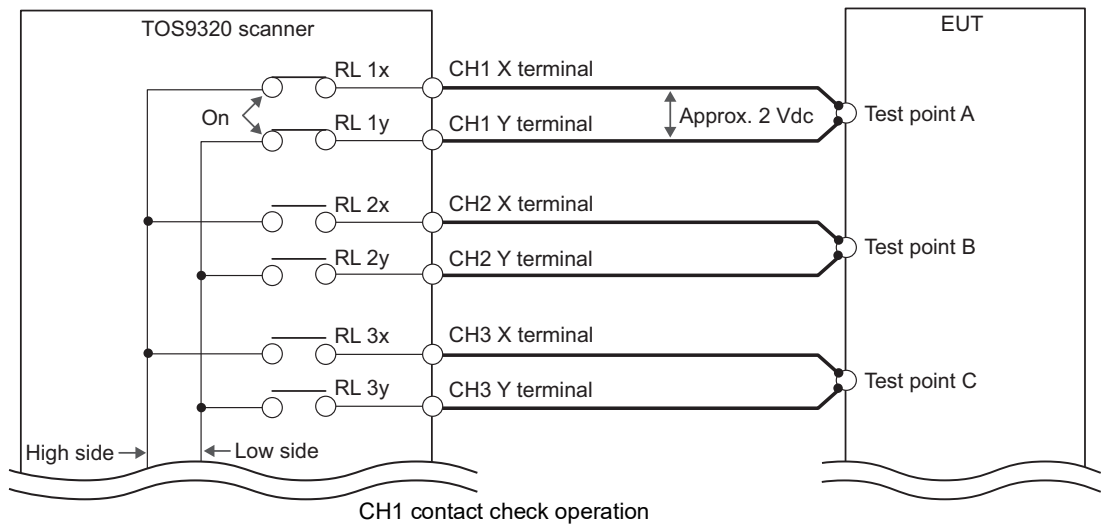

For example, assume that test point A is set to high voltage (CH1 to high) and test point C to low voltage (CH3 to low).

When you press START, "READY" disappears from the display, and the TOS93 series tester checks the continuity between CH1 and test point A. Next, the tester checks the continuity between CH3 and test point C. In this way, the tester performs a contact check for each channel in order, verifies the continuity of all channels set to high or low, and then starts the test. A contact check is not performed on channels set to open. On the front panel of the TOS9320 scanner, the LED of channels being checked lights orange.

As shown in the following figure, if there is a poor connection or broken test leads between the TOS9320 scanner and the EUT, the tester detects a poor contact because no current flows between the X or Y terminal and the test point. In this situation, the TOS93 series tester shows "C-FAIL" (CONTACT FAIL) on the display and ends the contact check.

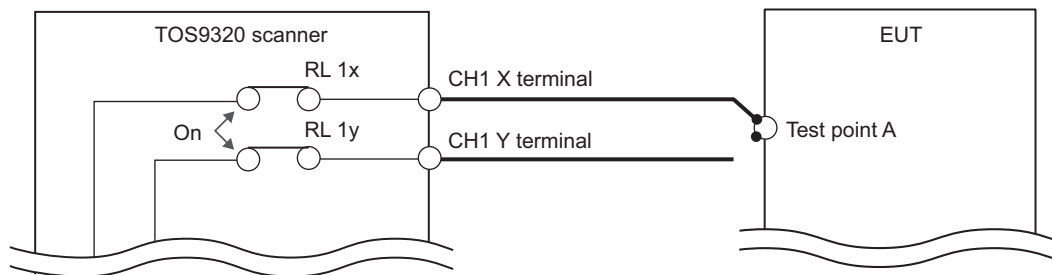

When there is a poor connec-

Examples of connecting a scanner and EUT

The following shows the examples of connections when the contact check function is used and not used.

■ When the contact check function is not used

The diagram below shows an example of a connection to conduct a withstanding voltage test using the X terminal of CH1 (set to High) and the Y terminal of CH2 (set to Low).

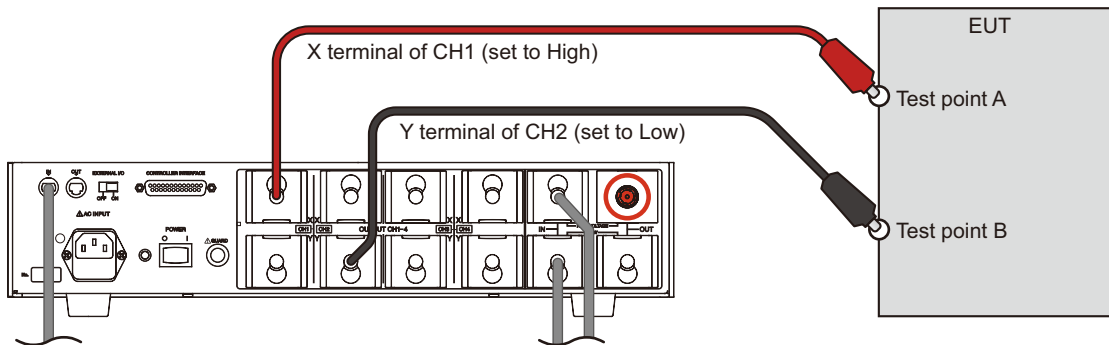

■ When the contact check function is used

The diagram below shows an example of a connection to conduct a withstanding voltage test using the X and Y terminals of CH1 (set to High) and CH2 (set to Low).

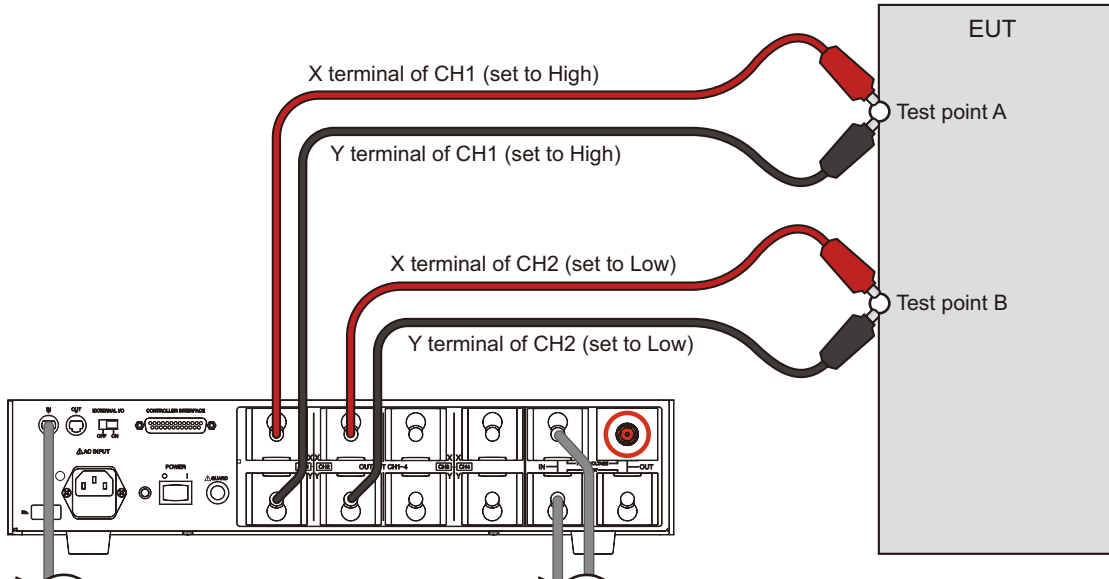

As shown below, if there is no continuity between the X and Y terminals, Contact-FAIL will result. In such a case, a test cannot be started.

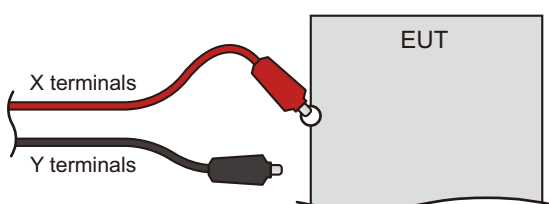

Reducing the effect of noise

Electronic devices in the surrounding area may malfunction due to the effect of noise produced by short circuits across outputs or a dielectric breakdown of the EUT. To reduce the effect of noise, connect a toroidal core or a resistor of approximately $470\ \Omega$ between the tips of the high- and low-voltage test leads and the EUT. Connect the toroidal core or resistor as close to the EUT as possible.

If you are connecting a toroidal core, it is effective to wrap the test leads two to three times around a type of core that can be snapped on and that is often used with power cables. This type of core is usually approximately 20 mm in diameter.

If you are connecting a resistor, pay close attention to the power rating of the resistor. When the upper limit is 10 mA or less, connect a resistor of approximately $470\ \Omega$ (3 W, 30 kV impulse withstanding voltage). Because connecting the resistor causes the voltage to fall, the voltage that is actually applied to the EUT is slightly lower than the voltage that is generated from the product's output terminals (when a 10 mA current flows, the voltage falls approximately 10 V).

These methods are extremely useful in reducing the effect of noise.

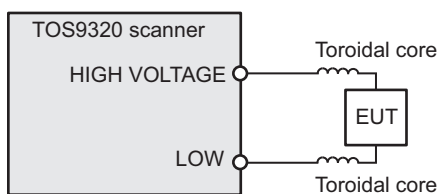

When connecting toroidal cores

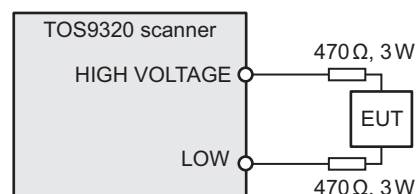

When connecting resistors

Stabilizing measurements

If measurements are unstable due to the effect of noise, such as when making highly sensitive measurements, using a shield box can stabilize the measurements. When using a shield box, connect the shield box's chassis connection wire to the GUARD terminal on the rear panel.

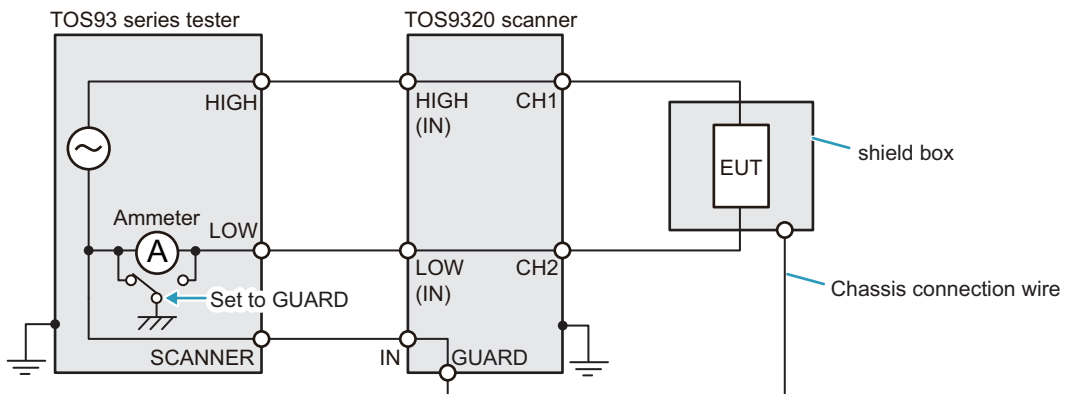

Connecting the EUT

⚠ WARNING

If you connect test leads to channels set to open, voltage may leak into those channels through the stray capacitance in the scanner and between test leads during the test and may cause electric shock.
 In normal cases, do not connect test leads to channels that are not used in the test. If you connect test leads to such channels (for example, when you need to switch the points that voltages are applied to while test leads are connected to multiple test points), set those channels to low.

- 1** Turn off the **POWER** switch on the tester.
- 2** Before connecting, check that the test leads that you will use are not broken and that their insulation is not damaged.
- 3** Connect the supplied high-voltage test leads (red) to the X terminals and low-voltage test leads (black) to the Y terminals of the channels to be used in the test.

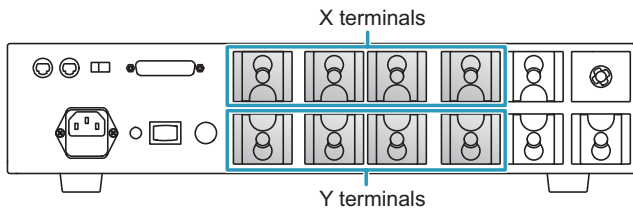

Secure the leads firmly with cable locks.

If you are not performing a contact check, you do not need to connect test leads to both X and Y terminals, as shown in “4 channel test system” (p. 20).

- 4** Connect all the test leads of the low voltage side (black) to the EUT.
- 5** Connect all the test leads of the high voltage side (red) to the EUT.
- 6** Check the test lead connections one more time.

Check that the cable locks are firmly secured.

Note that if several scanners are connected in parallel, the channel numbers as seen from the tester are different from the channel numbers of each scanner (p. 16). Check that the channels configured on the tester match the channels of the test points that test leads are connected to.

NOTE

To make the association between the connected test lead and channels clear, affix the supplied channel labels to the test leads.

Disconnecting test leads from the EUT



To remove the test leads connected to the EUT, follow the procedure below.

- 1** Check that the **DANGER LED** is turned off.
 - 2** Disconnect all the high-voltage test leads (red) from the EUT.
 - 3** Disconnect all the low-voltage test leads (black) from the EUT.
- This completes the procedure.

External Control

The CONTROLLER INTERFACE connector can be used to control channels from an external device.

Turning External Control On and Off

External control is turned on and off using the EXTERNAL I/O switch on the rear panel.

Setting the EXTERNAL I/O switch to on enables external control.

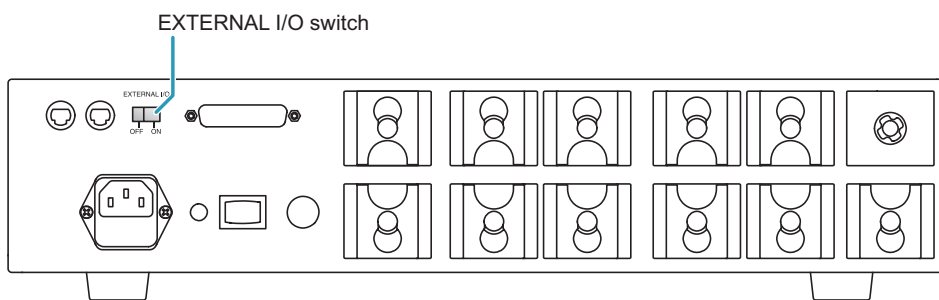

CONTROLLER INTERFACE Connector

Check the connector specifications, and then connect the external device to the CONTROLLER INTERFACE connector.

Pin arrangement

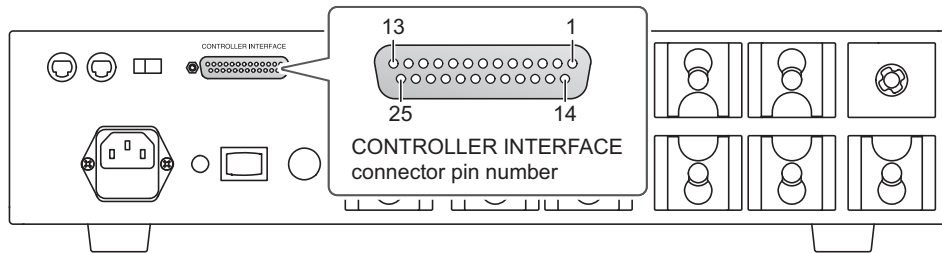

No.	Signal name	IN/OUT	Description
1	1CH HIGH SET	IN	Low level sets CH1 to high.
2	2CH HIGH SET	IN	Low level sets CH2 to high.
3	3CH HIGH SET	IN	Low level sets CH3 to high.
4	4CH HIGH SET	IN	Low level sets CH4 to high.
5	1CH LOW SET	IN	Low level sets CH1 to low.
6	2CH LOW SET	IN	Low level sets CH2 to low.
7	3CH LOW SET	IN	Low level sets CH3 to low.
8	4CH LOW SET	IN	Low level sets CH4 to low.
9	NC	–	–
10	NC	–	–
11	NC	–	–
12	COM	–	I/O circuit common (chassis potential).
13	NC	–	–
14	NC	–	–
15	1CH HIGH	OUT	Low level when CH1 is high.
16	2CH HIGH	OUT	Low level when CH2 is high.
17	3CH HIGH	OUT	Low level when CH3 is high.
18	4CH HIGH	OUT	Low level when CH4 is high.
19	1CH LOW	OUT	Low level when CH1 is low.
20	2CH LOW	OUT	Low level when CH2 is low.
21	3CH LOW	OUT	Low level when CH3 is low.
22	4CH LOW	OUT	Low level when CH4 is low.
23	ENABLE	IN	High level sets all channels to open.
24	NC	–	–
25	COM	–	I/O circuit common (chassis potential).

I/O signal circuit

The input signal circuit and the output signal circuit share the same common. The input terminal is pulled up to +12 V by a resistor. Opening the input terminals is equivalent to high-level input.

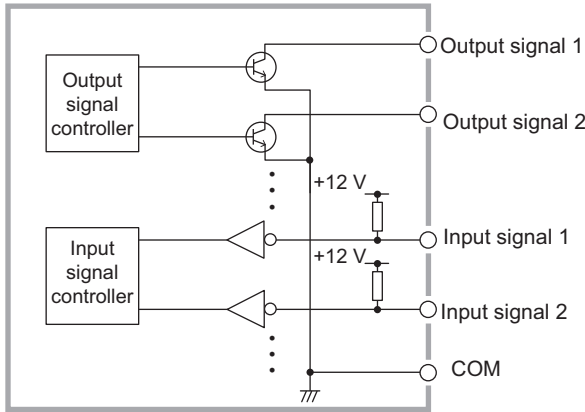

Internal structure of the CONTROLLER

Input signal

- Low-active control
- High-level input voltage: 11 V to 15 V
- Low-level input voltage: 0 V to 4 V
- Low-level input current: -5 mA max.
- Input time width: 5 ms min.

Output signal

- Open collector output
- Output withstanding voltage: 30 Vdc
- Output saturation voltage: Approx. 1.1 V (25°C, 77°F)
- Maximum output current 400 mA (TOTAL)

Input signal usage example

Using a make contact to control input

Use a make contact, such as a relay or switch, to set the input terminal to low level.

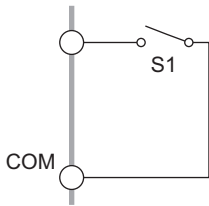

Using a logic element to control input

Use a logic element, such as a transistor, in place of the make contact. Design the circuit so that a transistor collector current (i_c) of 5 mA or greater flows.

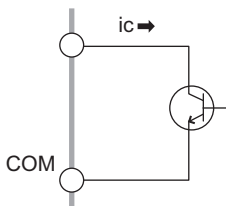

Output signal usage example

Driving a relay

Use the output signal to drive a relay. To improve the safety of the circuit, we recommend that you insert a protection fuse or connect a diode.

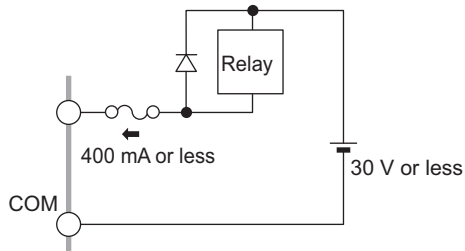

Obtaining a low-level digital signal

Use the output signal to obtain a low-level digital signal.

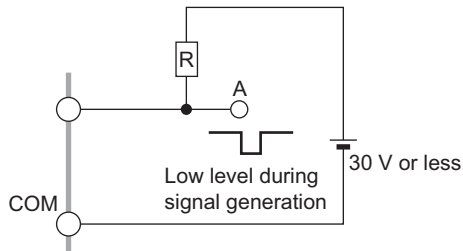

Connecting to the CONTROLLER INTERFACE connector

To connect the signal cable to the CONTROLLER INTERFACE connector, use the included CONTROLLER INTERFACE plug.

CONTROLLER INTERFACE connector specifications	D-sub 25-pin female connector (socket), M2.6 x 0.45 screws
Compatible plug	Supplied CONTROLLER INTERFACE plug D-sub 25-pin male (with M2.6 fix screw) To prevent malfunction caused by noise, use a shielded plug.
Required cable	Single wire: 0.32 mm (AWG28) to 0.65 mm (AWG22) in diameter Twisted wire: 0.32 mm ² (AWG22) to 0.08 mm ² (AWG28) To prevent malfunction caused by noise, use a cable no longer than 2.5 m.
Required tools	Wire stripper for the above cable

Maintenance

To purchase accessories or options, contact your Kikusui agent or distributor.

Pre-Test Inspection

To prevent accidents, inspect the following at the minimum before starting work.

- Check that there are no breaks, cracks, or tears in the insulation of the high voltage test leads.
- Check that the high voltage test leads are not broken.
- Short the tips of the low-voltage test lead (Y output terminal) and high-voltage test lead (X output terminal) of each channel. Turn on the tester's contact check function, and check that CONTACT FAIL does not occur when a test is started with test voltage set at 0 V.
- Open the tips of the low-voltage test lead (Y output terminal) and high-voltage test lead (X output terminal) of each channel. Turn on the tester's contact check function, and check that CONTACT FAIL occurs when a test is started with test voltage set at 0 V.
- Short the tips of the test leads between channels that tests will be performed on, and check that UPPER FAIL occurs when the output voltage is gradually increased.

Cleaning the Panels

If the panel needs cleaning, gently wipe using a soft cloth with water-diluted neutral detergent.

 **WARNING** To avoid electric shock, be sure to turn the **POWER** switch off, and remove the power cord plug from the outlet.

 **CAUTION** Do not use volatile solvents such as thinner or benzine. They may discolor the surface or erase the printed characters.

Specifications

Unless specified otherwise, the specifications are for the following settings and conditions.

- The warm-up time is 30 minutes (with current flowing).

The used terminology is as follows:

- TYP: These are typical values that are representative of situations where the product operates in an environment with an ambient temperature of 23 °C (73.4°F). These values do not guarantee the performance of the product.
- set: Indicates a setting.
- range: Indicates the rated value of each range.
- reading: Indicates the readout value.

Basic specifications

Item		Specifications
Maximum operating voltage	AC	5 kV
	DC	7.2 kV
Number of channels		4 (Each channel can be set to high, low, or open.)
Maximum connections		4 units Channel numbers are assigned according to the order in which connections are made to the TOS93 series tester. 1st scanner: CH1 to CH4 2nd scanner: CH5 to CH8 3rd scanner: CH9 to CH12 4th scanner: CH13 to CH16
Contact check function		Available
Indicators	DANGER	Lights in sync with the TOS93 series tester
	CHANNEL	Indicates the setting of each channel with color Red: High Green: Low Orange: Contact being checked Off: Open
	EXTERNAL	Lights when external control is on
	POWER	Lights when the power is on

Interface and other functions

Item	Specifications
Control switch	EXTERNAL I/O switch for switching the following controls. ON: External control through the CONTROLLER INTERFACE OFF: Control from the TOS93 series tester
CONTROLLER INTERFACE (external control)	D-sub 25-pin connector. For the pin arrangement, see p. 27 .
Function	Sets each channel to high or low or all channels to open. Outputs the setting of each channel.
Input	The input signals are all low-active control. The input terminal is pulled up to +12 V by a resistor. Leaving the input terminal open is equivalent to applying a high level signal.
High-level input voltage	11 V to 15 V
Low-level input voltage	0 V to 4 V
Low-level input current	-5 mA max.
Input time width	5 ms min.
Output	
Output method	Open collector output (4.5 Vdc to 30 Vdc)
Output withstanding voltage	30 Vdc
Output saturation voltage	Approx. 1.1 V (25°C, 77°F)
Maximum output current	400 mA (TOTAL)
TOS93 series tester interface	MINI DIN 8-pin connector Up to 4 units (16 channels) can be connected.

General specifications

Item		Specifications	
Environment	Installation location	Indoors, 2000 m or less	
	Spec guaranteed range	Temperature	5°C to 35°C (41°F to 95°F)
		Humidity	20%rh to 70%rh (no condensation)
	Operating range	Temperature	0°C to 40°C (32°F to 104°F)
		Humidity	20%rh to 80%rh (no condensation)
	Storage range	Temperature	-20°C to 70°C (-4°F to 158°F)
Humidity		90%rh or less (no condensation)	
Power supply	Nominal voltage range (allowable voltage range)	100 Vac to 240 Vac (90 Vac to 250 Vac)	
	Power consumption	50 VA max.	
	Allowable frequency range	47 Hz to 63 Hz	
Insulation resistance (between AC LINE and chassis)		30 MΩ or more (500 Vdc)	
Withstanding voltage (between AC LINE and chassis)		1500 Vac for 1 minute, 20 mA or less	
Earth continuity		25 Aac/0.1 Ω or less	
Dimensions		See p. 34 .	
Weight		Approx. 8 kg (17.6 lb)	
Accessories		See p. 3 .	
Electromagnetic compatibility ^{1 2}		<p>Complies with the requirements of the following directive and standards.</p> <p>EMC Directive 2014/30/EU EN 61326-1 (Class A³) EN 55011 (Class A³, Group 1⁴) EN 61000-3-2 EN 61000-3-3</p> <p>Applicable under the following conditions The maximum length of all cabling and wiring connected to this product is less than 2.5 m. A shielded cable is used for the connection to the CONTROLLER INTERFACE. The high-voltage test lead TL31-TOS is in use. Electrical discharges are applied only to the EUT.</p>	
Safety ¹		<p>Complies with the requirements of the following directive and standards.</p> <p>Low Voltage Directive 2014/35/EU² EN 61010-1 (Class I⁵, Pollution Degree 2⁶)</p>	

1 Does not apply to specially ordered or modified products.

2 Only on models that have CE/UKCA marking on the panel.

3 This is a Class A instrument. This product is intended for use in an industrial environment. This product may cause interference if used in residential areas. Such use must be avoided unless the user takes special measures to reduce electromagnetic emissions to prevent interference to the reception of radio and television broadcasts.

4 This is a Group 1 instrument. This product does not generate and/or use intentionally radio-frequency energy, in the form of electromagnetic radiation, inductive and/or capacitive coupling, for the treatment of material or inspection/analysis purpose.

5 This is a Class I instrument. Be sure to ground this product's protective conductor terminal. The safety of this product is guaranteed only when the product is properly grounded.

6 Pollution is addition of foreign matter (solid, liquid or gaseous) that may produce a reduction of dielectric strength or surface resistivity. Pollution Degree 2 assumes that only non-conductive pollution will occur except for an occasional temporary conductivity caused by condensation.

External dimensions

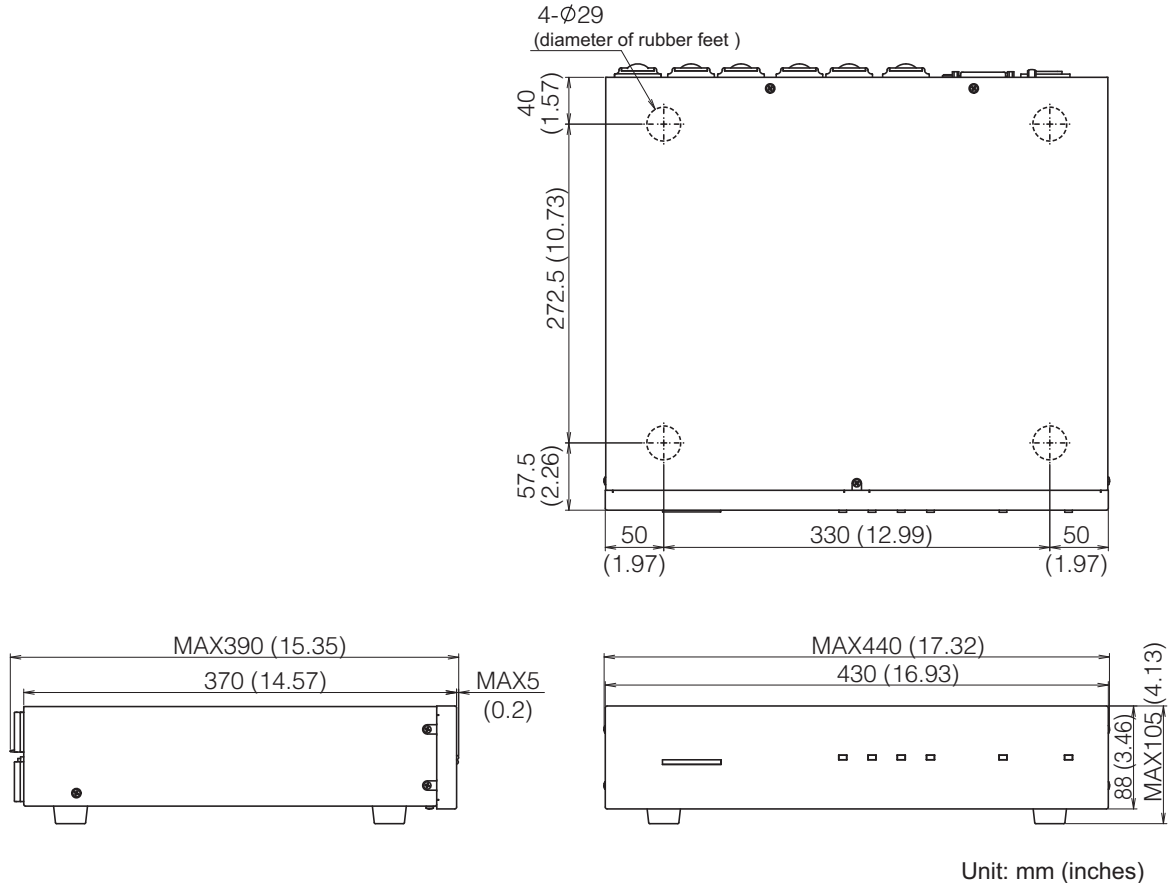

Appendix

Timing Charts (Contact check operation)

■ Setting conditions

Model: TOS9301 (connect a high voltage scanner)

Contact Check: ON

CH1 to CH4 of the scanner: Low

Rise Time: ON

Test Time: ON

Start the test with the SIGNAL I/O

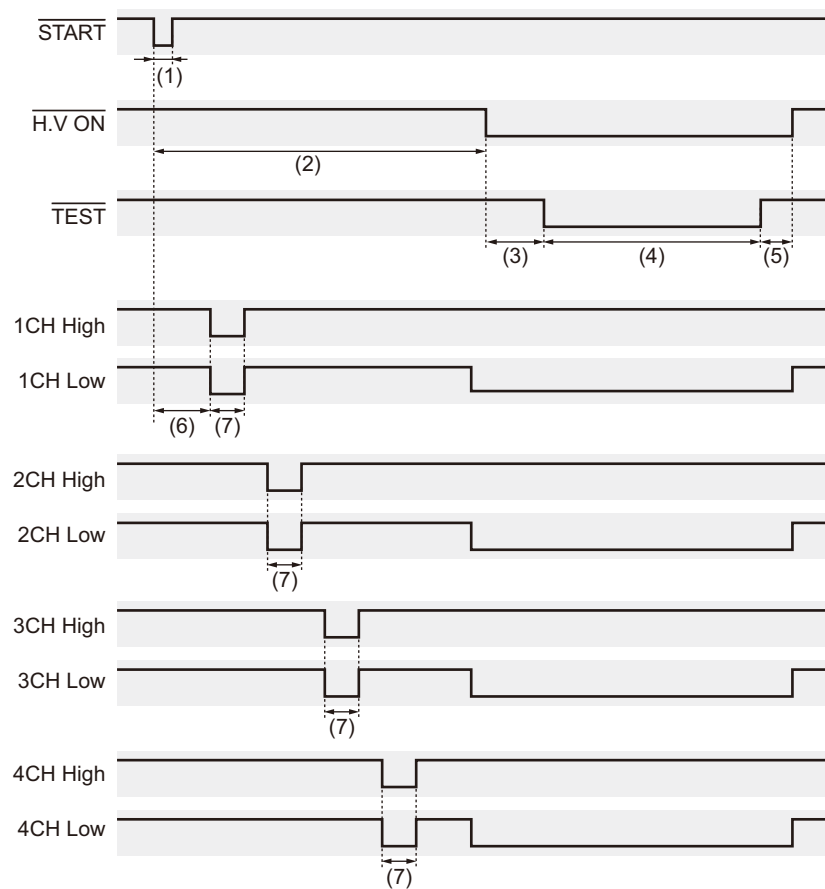

No.	Description
(1)	5 ms min.
(2)	Approx. 180 ms ¹
(3)	Rise Time
(4)	Test Time
1	TYP (typical value)

No.	Description
(5)	Varies depending on the EUT
(6)	Approx. 50 ms ¹
(7)	Approx. 30 ms ¹

Rack mounting (option)

The following two types of brackets are available as rack mounting options.

- KRB2-TOS: EIA inch rack Standard
- KRB100-TOS: JIS millimeter rack standard

For information about options, contact your Kikusui agent or distributor.
To rack mount the product, remove the rubber feet from the product.

NOTE When mounting the product on a rack, be sure to use support angles (auxiliary brackets) to safely support the product.

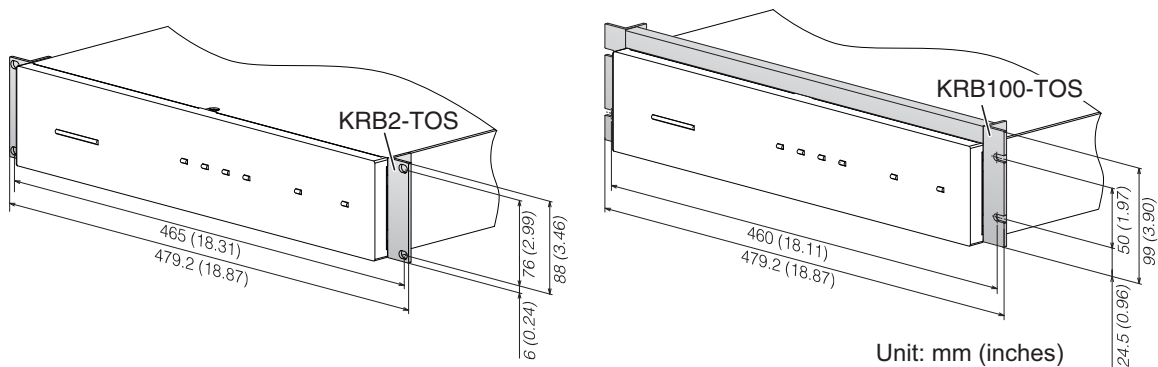

Removing the feet

We recommend that you keep all pieces that you remove from the product. You will need these pieces if you remove the product from the rack.

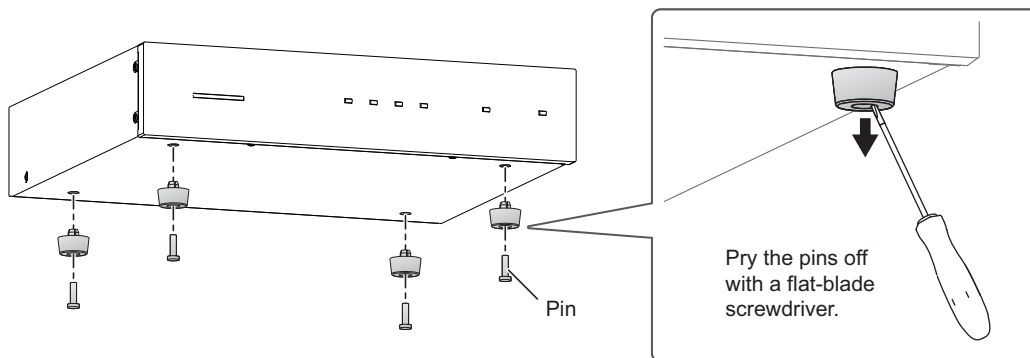

1 Pry off the pins holding the legs (four locations) with a flat-blade screwdriver.

2 Remove the four feet.

This completes the removal.

For information on rack mounting, see the operation manual of the relevant bracket.

Troubleshooting

This section introduces troubleshooting measures. Typical symptoms are listed. Check whether any of the items listed below apply to your case. In some cases, the problem can be solved quite easily.

If following the remedy does not solve your problem, contact your Kikusui agent or distributor.

When contacting us about the product, please provide us with:

The model (marked in the upper left of the front panel)

The serial number (marked on the rear panel)

■ The POWER LED does not light.

Possible cause	Remedy	See
The power cord is disconnected.	Connect the power cord.	p. 13
The interface cable is disconnected.	Connect the interface cable.	p. 15

■ The POWER LED is lit, but the product does not operate.

Possible cause	Remedy	See
The TOS93 series tester's SCANNER connector is connected to the TOS9320 scanner's OUT connector.	When connecting to the tester, connect the interface cable between the tester's SCANNER connector and the TOS9320 scanner's IN connector.	p. 15
A channel not configured on the TOS93 series tester is being used.	On the TOS93 series tester, set each channel to high, low, or open. For the setup procedure, see the TOS93 series tester user's manual.	–

■ When contact check is set to on, FAIL occurs immediately when START is pressed.

Possible cause	Remedy	See
The lead for high voltage parallel connection is disconnected.	Connect the lead for high voltage parallel connection.	p. 15
The X and Y terminals of OUTPUT CH1 to CH4 are not wired to the test points. Or the wiring is disconnected.	Connect the product to the EUT with the high-voltage test leads.	p. 15

Index

C

C-FAIL	21
channel number	16
component names	7
connections, number of	15
contact check	21
continuity check	21
CONTROLLER INTERFACE connector	26, 27

D

DANGER LED	9
------------------	---

E

EXTERNAL I/O switch	26
---------------------------	----

G

GUARD terminal	23
----------------------	----

H

HIGH VOLTAGE terminal	17
-----------------------------	----

I

IN terminal	17
input signal	28
interface cable	17

L

lead for high voltage parallel connection	17
---	----

N

noise	23
-------------	----

O

option	36
OUT terminal	17
OUTPUT CH1-4	19
output signal	28

P

power on/off	14
POWER switch	14

S

SCANNER connector	17
shield box	23
specifications	31

T

troubleshooting	37
-----------------------	----

X

X terminal	19, 24
------------------	--------

Y

Y terminal	19, 24
------------------	--------

Warranty Period

Before delivery, our products have undergone strict testing and inspections and have been found to comply with the specifications. We offer different warranty periods for different product models. If the product should become defective within the specific warranty period applied to the product model after the date of purchase, we will repair the product or replace it with a new one for free. In a case in which the customer concluded a separate agreement with us regarding the warranty period, the conditions of the warranty period are applied based on such agreement.

Scope of Warranty

If the product should become defective within the warranty period, we will repair the product or replace it with a new one. However, the warranty does not cover:

- Failure or damage caused by use that is not in accordance with the Operation Manual, misuse, or neglect.
- Failure or damage during transportation after delivery.
- Failure or damage caused by improper modification, adjustment, or repair.
- Failure or damage caused by an Act of God, fire, or other events beyond our control.
- Failure or damage caused by use in a corrosive atmosphere, a dusty environment, or an environment where salt damage occurs or contamination by liquid or foreign matters is likely to occur.
- Failure or damage due to causes that are not attributable to us.

Disclaimer

Regardless of the warranty period, in no event shall we be liable for loss of opportunity or profit caused by the failure of our product, or initial or secondary damages, accident compensation, damages to products other than our products, or compensation for other operations caused by unavoidable circumstances that we may or may not have foreseen.

If you find any misplaced or missing pages in the manuals, they will be replaced. If the manual gets lost or soiled, a new copy can be provided for a fee. In either case, please contact your Kikusui agent or distributor. At that time, inform your agent or distributor of the "Part No." written on the front cover of this manual.

Every effort has been made to ensure the accuracy of this manual. However, if you have any questions or find any errors or omissions, please contact your Kikusui agent or distributor.

After you have finished reading this manual, store it so that you can use it for reference at any time.

KIKUSUI ELECTRONICS CORP.

1-1-3 Higashiyamata, Tsuzuki-ku, Yokohama,
224-0023, Japan

Phone: +81-45-482-6353

Facsimile: +81-45-482-6261

www.kikusui.co.jp/en

