

**Search by Topic 8**  
**Component Names 10**  
**General Description 13**  
**Product Overview 14**  
**Options 16**

**Installation and Preparation 19****Connecting the Power Cord 20****Using the Protection Cover 21****Turning the Power On 22****Connecting to the Device under Test (DUT) 24****Safety Precautions for Testing 27****Pre-Test Inspection 28****Testing Precautions 28****Remote Control Precautions 29****Interrupting Testing or Operations 29****Emergency Measures 29****Forbidden Actions 30****About Malfunctions 30****To Use the Product for a Long Time Free of Malfunctions 30****Panel Operation Basics 31****Parts of the Screen 32****Panel Operations 34****Panel Memory 37****Withstanding Voltage Test 39****About Judgment 40****Invalid Settings 40****Setting Test Conditions 41****CONFIG Settings 44****Starting a Test 48****Finishing a Test 51****External Control 53****SIGNAL I/O Connector 54****Starting a Test 57****Recalling Panel Memory and Test Modes 58****Interlock Feature 59****STATUS OUT connector 60****Maintenance 61****Pre-Test Inspection 62****Specifications 63****Appendix 71****List of Default Settings 72****Protection Functions 74****Test Start Operation and Display 75****Timing chart 76****Troubleshooting 79**

# User's Manual

## Withstanding Voltage Tester

# TOS5200

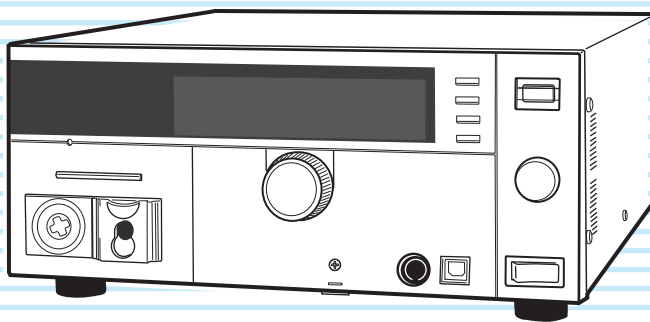

### **DANGER**

**This product generates high voltage!**

- Improper operation can lead to serious accidents.
- To prevent accidents, be sure to read the section “Safety Precautions during Testing” in this manual.
- Keep this manual close to the product so that the operators can read the manual at any time.

## About the Manuals

These manuals are intended for users of the Withstanding Voltage Tester and their instructors. Explanations are given under the presumption that the reader has knowledge related to electricity.

## Manual construction

### ■ Setup Guide

This manual is intended for first-time users of the product. It gives an overview of the product, connecting procedures, safety precautions, etc. Please read this manual before you operate the product.

### ■ Quick Reference

The quick reference briefly explains the control panel and the basic operation of it.

### ■ Safety Information

This document contains general safety precautions for this product. Keep them in mind and make sure to observe them.

### ■ User's Manual (this manual, PDF)

This manual is intended for first-time users of this product. It provides an overview of the product, notes on usage, and specifications. It also explains how to connect the product, configure the product, operate the product, perform maintenance on the product, and so on.

### ■ Communication Interface Manual (PDF)

This manual explains how to control the product remotely using commands. It is included on the CD-ROM. The interface manual is written for readers with sufficient basic knowledge of how to control measuring instruments using a PC.

PDF files are included in the accompanying CD-ROM.

The newest version of the operation manual can be downloaded from Download service of Kikusui website.

## Firmware versions that this manual covers

This manual covers firmware versions 1.0X. When contacting us about the product, please provide us with:

Model (marked in the top section of the front panel)

The firmware version (see page 23)

The serial number (marked in the bottom section of the rear panel)

## Trademarks

Microsoft, Windows, and Visual Basic are registered trademarks of Microsoft Corporation in the United States and/or other countries.

All company names and product names used in this manual are trademarks or registered trademarks of their respective companies.

## Copyrights

The contents of this manual may not be reproduced, in whole or in part, without the prior consent of the copyright holder.

The specifications of this product and the contents of this manual are subject to change without prior notice.

© 2014 Kikusui Electronics Corporation

## Checking the Package Contents

When you receive the product, check that all accessories are included and that the accessories have not been damaged during transportation.

If any of the accessories are damaged or missing, contact your Kikusui agent or distributor.

We recommend that you save all packing materials, in case the product needs to be transported at a later date.



Rating: 125 Vac, 10 A  
Plug: NEMA5-15  
[85-AA-0003]

or

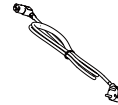

Rating: 250 Vac, 10 A  
Plug: CEE7/7  
[85-10-1070]

or



Rating: 250 Vac, 10 A  
Plug: GB1002  
[85-10-0791]

- Power cord (1 pc.)  
Length: Approx. 2.5 m

The power cord that is provided varies depending on the destination for the product at the factory-shipment.

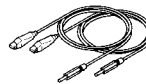

- High-voltage test lead (1 set)  
[TL31-TOS]



- High-voltage warning sticker (1 pc.)



- SIGNAL I/O plug (1 set)  
Assembly type (D-sub plug unit)



- CD-ROM (1 pc.)

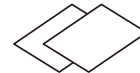

- Japanese (1 sheet)  
English (1 sheet)  
 Quick Reference

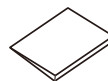

- Setup Guide (1 pc.)

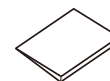

- Safety Information (1 pc.)

## Notes to the supervisor

- If the operators cannot understand the language used in this manual, translate the manuals into the appropriate language.
- Make sure that the operators understand the information in this manual before they operate this product.
- Keep this manual close to the product so that the operators can read the manual at any time.
- If the tester will be used to repeatedly perform tests with fixed conditions, such as when being used as part of a manufacturing line, attach the protection cover to ensure safe operation of the tester. This is useful in preventing incorrect operation of the tester.

## Dangerous Operations

You will receive a potentially fatal electric shock if:

- You touch an output terminal while output is being generated.
- You touch a test lead that is connected to an output terminal while output is being generated.
- You touch the device under test (DUT) while output is being generated.
- You touch a location that is electrically connected to an output terminal while output is being generated.

You may receive a potentially fatal electric shock if:

- You operate the tester without grounding it.
- You operate the tester without using rubber gloves for electrical work.
- You come close to a location that is electrically connected to an output terminal while output is being generated.



## Safety Precautions

When using this product, be sure to observe the “Safety Precautions” in the Safety information manual.



## Precautions Concerning Installation Location

When installing this product, be sure to observe the “Precautions Concerning Installation Location” in the Safety information manual. The following precautions pertain only to this product.

- When installing this product, be sure to observe the temperature and humidity ranges indicated below.
  - Operating temperature range: 0 °C to +40 °C (32 °F to 104 °F)
  - Operating humidity range: 20 %rh to 80 %rh (no condensation)
- When storing this product, be sure to observe the temperature and humidity ranges indicated below.
  - Storage temperature range: -20 °C to +70 °C (-4 °F to 158 °F)
  - Storage humidity range: 90 %rh or less (no condensation)
- Do not use the product in a poorly ventilated location. The product uses forced air cooling. It sucks air through the inlet holes on its right, and left panels, and then expels air through its rear panel. Secure adequate space around the product’s inlet and outlet holes to prevent the possibility of fire caused by accumulation of heat.
 

Allow at least 20 cm of space between the inlet and outlet holes on the side and rear panels and the walls (or obstacles).

Hot air (approximately 20°C, 68 °F, hotter than the ambient temperature) is expelled from the outlet holes. Do not place objects that are affected by heat near the air outlet.

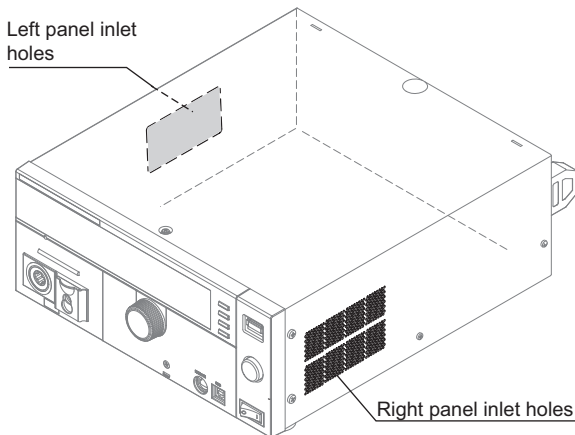

- Do not use this product near highly sensitive measuring instruments or receivers.
 

Noise generated by this product may affect other devices. At a test voltage of 3 kV or greater, the product may produce corona discharge between its test lead clips. This will generate a significant amount of broadband RF emission. To minimize this effect, keep the alligator clips away from each other. Also, keep the alligator clips and test leads away from conducting surfaces, especially sharp metal edges.

## Notations Used in This Manual

- The TOS5200 Withstanding Voltage Tester is also referred to as the TOS5200.
- Device under test is also referred to as DUT.
- The term “PC” is used to refer generally to both personal computers and workstations.
- The following markings are used in the explanations in this manual.

### WARNING

Indicates a potentially hazardous situation which, if ignored, could result in death or serious injury.

### CAUTION

Indicates a potentially hazardous situation which, if ignored, may result in damage to the product or other property.

### NOTE

Indicates information that you should know.

### DESCRIPTION

Explanation of terminology or operation principle.

### See

Indicates a reference to detailed information.

### SHIFT+key name (blue letters)

Indicates an operation that requires you to press a key indicated in blue letters while holding down SHIFT.

### Memo

Indicates useful information.

# Contents

About the Manuals .....	2
Checking the Package Contents .....	2
Notes to the supervisor .....	3
Dangerous Operations .....	3
Safety Precautions .....	4
Precautions Concerning Installation Location .....	4
Notations Used in This Manual .....	4
Contents .....	5
Search by Topic .....	8
Component Names .....	10

## 1 General Description

Product Overview .....	14
Features .....	14
Options .....	16

## 2 Installation and Preparation

Connecting the Power Cord .....	20
Using the Protection Cover .....	21
Turning the Power On .....	22
Checking indicators and the status of the interlock feature .....	22
Turning the POWER switch on .....	23
Turning the POWER switch off .....	23
Connecting to the Device under Test (DUT) .....	24
Using test leads .....	24
Using the optional high voltage test probe (model HP01A-TOS/HP02A-TOS) .....	26
Disconnecting test leads from the DUT .....	26

## 3 Safety Precautions for Testing

Pre-Test Inspection .....	28
Testing Precautions .....	28
Remote Control Precautions .....	29
Interrupting Testing or Operations .....	29
Emergency Measures .....	29
Forbidden Actions .....	30
Turning the power on and off repeatedly .....	30
About Malfunctions .....	30
To Use the Product for a Long Time Free of Malfunctions .....	30

## 4 Panel Operation Basics

Parts of the Screen .....	32
Panel Operations .....	34
Switching screens .....	34
Selecting items .....	35
Entering values .....	35
Locking panel operations (key lock) .....	36
Talk mode .....	36

Panel Memory.....	37
Saving test conditions .....	37
Recalling test conditions.....	38

## 5 Withstanding Voltage Test

About Judgment.....	40
Effectiveness of the lower limit.....	40
Invalid Settings.....	40
Setting Test Conditions.....	41
Test conditions (basic items).....	41
Test conditions (additional items).....	42
CONFIG Settings.....	44
CONFIG 1 settings.....	44
CONFIG 2 settings.....	46
Starting a Test.....	48
To start a test .....	48
When a test starts .....	48
To change the voltage setting during a test .....	49
If you cannot start testing .....	49
Finishing a Test.....	51
To stop a test .....	51
When a test finishes.....	51
To clear judgment results.....	52

## 6 External Control

SIGNAL I/O Connector.....	54
SIGNAL I/O specifications .....	54
Internal construction .....	56
Input signal usage example .....	56
Output signal usage example .....	57
Starting a Test.....	57
Recalling Panel Memory and Test Modes .....	58
Interlock Feature .....	59
How to use the interlock feature.....	60
STATUS OUT connector.....	60

## 7 Maintenance

Pre-Test Inspection.....	62
Inspection of test leads and the judgment feature .....	62
Calibration.....	62

## 8 Specifications

Withstanding voltage tester.....	64
Other features.....	66
Interfaces.....	67
General.....	69
Outline drawing .....	70

## Appendix

<b>A List of Default Settings .....</b>	<b>72</b>
Initializing the TOS5200 .....	72
<b>B Protection Functions .....</b>	<b>74</b>

<b>C</b>	<b>Test Start Operation and Display</b> .....	<b>75</b>
<b>D</b>	<b>Timing chart</b> .....	<b>76</b>
	PASS judgment .....	76
	FAIL judgment.....	77
	Takt Time.....	78
<b>E</b>	<b>Troubleshooting</b> .....	<b>79</b>
	<b>Index</b> .....	<b>81</b>

## Preparation



- 
- **What accessories are included in the package?**  
→ “Checking the Package Contents” *p.2*

---

  - **Before I start testing, I want to check that the TOS5200 is operating safely.**  
→ “Turning the Power On” *p.22*

---

  - **How do I use each of the two test leads?**  
→ “Using test leads” *p.24*

---

  - **I want to check that measurements are being performed correctly before I start testing.**  
→ “Pre-Test Inspection” *p.62*

---

  - **I want to know more about the interlock feature.**  
→ “Interlock Feature” *p.59*
- 

## Setup



- 
- **Other than the basic settings that are shown on the panel, what test conditions can be set?**  
→ “Test conditions (additional items)” *p.42*  
→ “CONFIG Settings” *p.44*

---

  - **How are measured values judged?**  
→ “About Judgment” *p.40*

---

  - **How does the TOS5200 display the judgment results?**  
→ “When a test finishes” *p.51*

---

  - **How can I hold the PASS judgment result?**  
→ “Judgment result hold time (Pass Hold)” *p.45*
-



# Operation

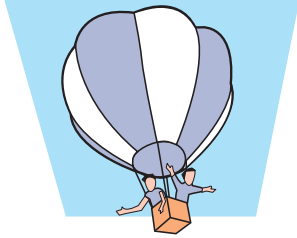

- **How do I save the present test conditions and use them later?**  
→ "Panel Memory" *p.37*
- **How do I start tests with a greater level of safety?**  
→ "Double action feature" *p.45*
- **How do I prevent unintentional key operations from changing the test conditions?**  
→ "Using the Protection Cover" *p.21*  
→ "Locking panel operations (key lock)" *p.36*
- **How do I control the TOS5200 using external signal input?**  
→ "SIGNAL I/O Connector" *p.54*
- **How do I release the interlock feature?**  
→ "Turning the Power On" *p.22*

# Maintenance



- **How do I check that the test leads are not damaged (for example, that they have no breaks)?**  
→ "Pre-Test Inspection" *p.62*
- **What do I need to keep in mind to use the TOS5200 for a long time without malfunctions?**  
→ "To Use the Product for a Long Time Free of Malfunctions" *p.30*

# Troubleshooting

See "Troubleshooting" on page 79.

# Component Names

## Front Panel

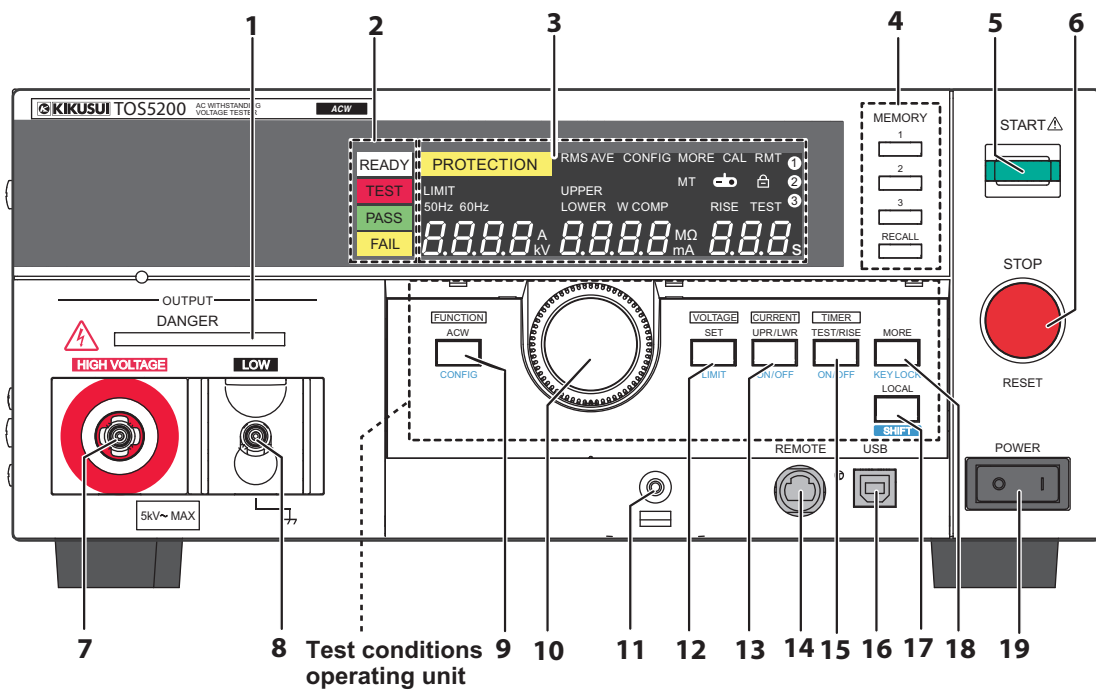

The protection cover is attached to the TOS5200 when the product is shipped from the factory.

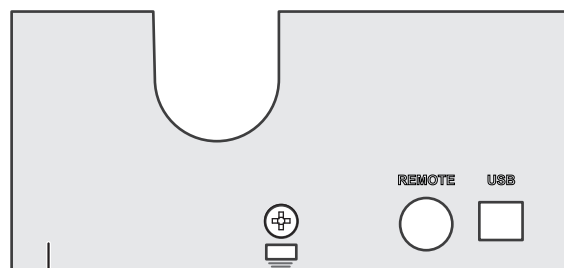

20

Loosen the screw and pull this part towards you to remove the cover.

No.	Name	Function	See
1	DANGER LED	Lights in red when a test is being performed.	p.48
2	Status indicators	READY: Lights in white when the TOS5200 is ready to perform a test.	p.48
		TEST: Lights in red when a test is being performed.	p.48
		PASS: Lights in green when a test passes.	p.51
3	Display	FAIL: Lights in yellow when a test fails.	p.51
		Displays the settings, measured values, and other information.	p.32

No.	Name	Function	
		Press these keys to display the settings that are saved to memory. When test conditions or configuration items are being set, these keys correspond to the menus displayed on the screen.	
4	MEMORY keys	MEMORY 1 key: Displays the settings saved to MEMORY 1. MEMORY 2 key: Displays the settings saved to MEMORY 2. MEMORY 3 key: Displays the settings saved to MEMORY 3. RECALL key: Recalls settings from panel memory. +SHIFT key: <sup>1</sup> Saves the current settings to panel memory.	<i>p. 37, p. 44</i>
5	START switch	Starts testing.	<i>p. 48</i>
6	STOP switch	Stops testing and clears the current status.	<i>p. 51, p. 74</i>
7	HIGH VOLTAGE terminal	This terminal is for the high-voltage line of the tester output.	<i>p. 24</i>
8	LOW VOLTAGE terminal	This terminal is for the low-voltage line of the tester output (with cable lock).	<i>p. 24</i>
9	FUNCTION key (ACW key)	Does not use.	—
	CONFIG key	+SHIFT key: <sup>1</sup> Displays the CONFIG setup screen.	<i>p. 44</i>
10	Rotary knob	Changes settings.	<i>p. 35, p. 41, p. 44</i>
11	Screw hole	Fasten a screw to this hole to fix the protection cover in place.	—
12	SET key	Press to select the voltage setting.	<i>p. 35, p. 41</i>
	LIMIT key	+SHIFT key: <sup>1</sup> Selects the voltage limit setting.	
13	UPR/ LWR key	Press to alternately select the upper and lower current limits.	<i>p. 35, p. 41</i>
	ON/ OFF key	+SHIFT key: <sup>1</sup> Turns the lower limit judgment feature on and off.	
14	REMOTE connector	Specialized connector for connecting the optional remote control box, RC01-TOS/RC02-TOS, or the high voltage test probe, HP01A-TOS/HP02A-TOS.	<i>p. 16, p. 26</i>
15	TEST/ RISE key	Press to alternately select the test time and voltage rise time.	<i>p. 35, p. 41</i>
	ON/ OFF key	+SHIFT key: <sup>1</sup> Turns the test time (Test Time) on and off.	
16	USB port	USB interface connector.	Communication interface manual
17	LOCAL key	Switches between local mode and remote mode.	—
	SHIFT key	Press to access the features that are written in blue.	—
18	MORE key	Press to select additional test condition settings. Frequency, start voltage, voltage fall time, and measurement mode	<i>p. 41, p. 42</i>
	KEY LOCK key	+SHIFT key: <sup>1</sup> Locks panel key operations (settings and changes).	<i>p. 36</i>
19	POWER switch	Turns the power on [ I ] and off [ O ].	<i>p. 22</i>
20	Protection cover	Cover designed to prevent incorrect operation of the TOS5200.	<i>p. 21</i>

1 This indicates an operation that requires you to press a key while holding down SHIFT.

## Rear Panel

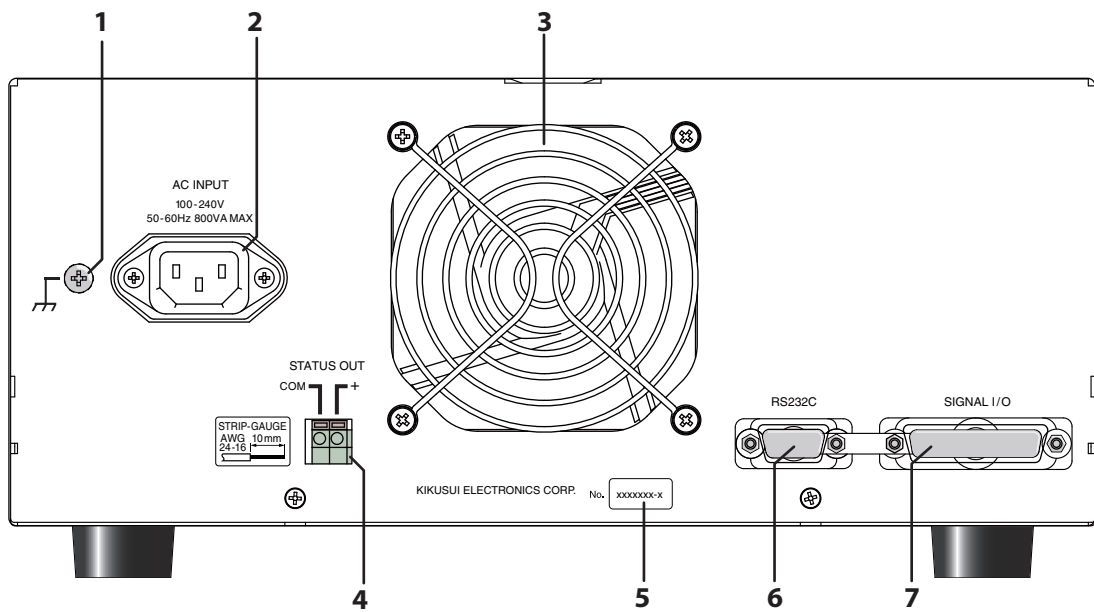

No.	Name	Function	<a href="#">See</a>
1	Chassis terminal	Functional ground terminal <sup>1</sup>	—
2	AC LINE connector	AC inlet	<i>p.20</i>
3	Air outlet	Air outlet for cooling	—
4	STATUS OUT connector	Connector for connecting the optional warning light unit, PL02-TOS	<i>p.17 , p.60</i>
5	Serial number	The product's serial number	—
6	RS232C port	RS232C interface connector	Communication interface manual
7	SIGNAL I/O connector	External control signal connector	<i>p.54</i>

1 A multipurpose ground terminal provided for the stable operation of the TOS5200. Use it if necessary.



# 1

---

## General Description

This chapter gives an overview of the TOS5200 and explains the options that are available for it.

# Product Overview

The TOS5200 Withstanding Voltage Tester performs withstanding voltage tests, which is one of the four types of tests<sup>1</sup> that are required for ensuring the safety of electrical products.

This product can perform AC withstanding voltage tests on electrical products and electrical components in accordance with the requirements of safety and electrical standards and ordinances such as IEC, EN, UL, VDE, and JIS.

It is suited to (1) research and development installations, (2) test facilities for quality assurance testing and standard certification, and (3) manufacturing lines.

The withstanding voltage tester is easy to use, safe, and reliable.

## Features

- **Newly developed constant-voltage output for stable testing**

The TOS5200 is not affected by AC line interference. Because the output voltage is maintained at a fixed value even if the AC line voltage or frequency changes, stable tests can be performed even in locations where the power supply is unstable.

The AC inlet is designed for worldwide use. The TOS5200 can be used without modification provided the nominal power supply voltage is within the range of 100 Vac to 240 Vac (90 Vac to 250 Vac) and the frequency is within the range of 47 Hz to 63 Hz.

- **Rise time control feature that gradually increases the test voltage**

Instead of immediately applying the specified test voltage to the DUT after the test begins, this makes it possible to perform tests in which the voltage is raised gradually to the test voltage. As required by withstanding voltage tests defined by standards such as IEC and UL, this makes it possible to perform tests in which no more than half of the test voltage is applied at the start of the test, and the test voltage is gradually reached over the specified time.

- **Fall time control feature that gradually decreases the test voltage**

The test voltage can be gradually decreased after a PASS judgment occurs during an AC withstanding voltage test.

- **Window comparator feature for setting upper and lower judgment limits**

You can set not only the upper limit, but the lower limit as well. This is useful in determining whether there are breaks in test leads or whether there was a mistake during operations. This leads to highly reliable tests.

- **Ability to save three sets of test conditions**

You can save three sets of test conditions.

- **Improved safety**

In addition to having features that enable you to view the output voltage, the TOS5200 also enables you to set the voltage limits, so you can prevent a voltage greater than what is necessary from being generated unintentionally. This provides protection for the DUT.

- **Standard-equipped USB port**

The TOS5200 is standard-equipped with a USB interface. You can use a PC or sequencer to control test conditions and read measured values and test results.

---

1 The four tests are the withstanding-voltage, insulation-resistance, earth-continuity, and leakage-current tests.

- **Light-weight and easy to move**

Even though the TOS5200 can generate 500 VA, which is sufficient for performing withstanding voltage tests, it only weighs 15 kg or less, so it can be moved by even a single person.

- **Protection against incorrect operations**

In addition to the key lock feature, the TOS5200 has a protection cover for the part of its panel that is used to change test conditions. This cover is useful in preventing incorrect operations when you want to perform tests with fixed conditions.

# Options

The following options are available for the TOS5200.  
For information about options, contact your Kikusui agent or distributor.

## Rack mount option

Name	Model	Note
Rack mount adapter	KRA4-TOS	For EIA inch racks
	KRA200-TOS	For JIS millimeter racks

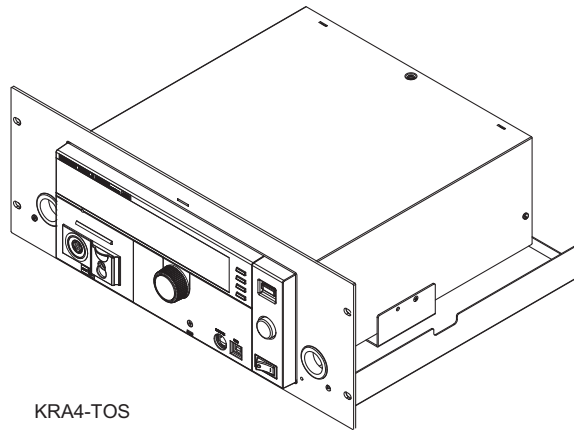

KRA4-TOS

## Model RC01-TOS/RC02-TOS remote control box

The remote control box can be used to start and stop withstanding voltage test. One model is for use with one hand, and the other model is for use with two hands. A DIN adapter cable is required to connect to the TOS5200.

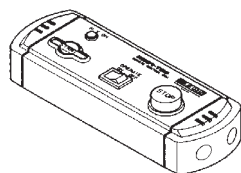

RC01-TOS (one hand)

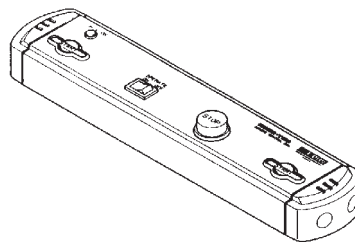

RC02-TOS (two hands)

## Model DD-5P/ 9P DIN adapter cable

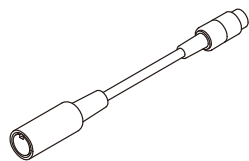

The DD-5P/9P DIN adapter cable (5 pin to 9 pin) is for connecting the following option products to the TOS5200.

- Remote control box(RC01-TOS/RC02-TOS)
- High voltage test probe(HP01A-TOS/HP02A-TOS)



## Model HP01A-TOS/HP02A-TOS high voltage test probe

See p. 26

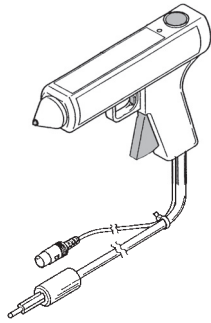

This is a probe for generating the test voltage. To prevent the test voltage from being generated unintentionally, this probe has been designed so that the test voltage is only generated when the user operates the probe with both hands. A DIN adapter cable is required to connect to the TOS5200.



**WARNING**

The maximum rated voltages of the HP01A-TOS/HP02A-TOS are 4 kVac and 5 kVdc. For safety reasons, set the Limit voltage (LIMIT) (p. 41 ) to limit the applied voltage.

## Model PL02-TOS warning light unit

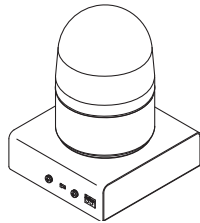

The warning light unit indicates that the TOS5200 is performing a test. This enables you to see that a test is in progress from a distance.



This page is intentionally blank.





# 2

---

## Installation and Preparation

This chapter describes how to prepare this product for use.

# Connecting the Power Cord

## WARNING

- This product conforms to IEC Safety Class I (equipment that has a protective conductor terminal). Be sure to earth ground the product to prevent electric shock.
- The product is grounded through the power cord ground wire. Connect the protective conductor terminal to earth ground.

## NOTE

- Use the supplied power cord to connect to the AC line. If the supplied power cord cannot be used because the rated voltage or the plug shape is incompatible, have a qualified engineer replace it with an appropriate power cord that is 3 m or less in length. If obtaining a power cord is difficult, contact your Kikusui agent or distributor.
- The power cord with a plug can be used to disconnect the product from the AC power line in an emergency. Connect the plug to an easily accessible power outlet so that the plug can be removed from the outlet at any time. Be sure to provide adequate clearance around the power outlet.
- Do not use the supplied power cord with other instruments.

This product conforms to IEC Overvoltage Category II (energy-consuming equipment that is supplied from a fixed installation).

In addition to the supplied power cord, Kikusui also provides other 200 V power cords with plugs (sold separately).

- 1 Check that the POWER switch is turned off.**
- 2 Check that the AC power line meets the nominal input rating of the product.**

The product can receive a nominal power supply voltage in the range of 100 Vac to 240 Vac (90 Vac to 250 Vac) that has a frequency in the range of 47 Hz to 63 Hz.
- 3 Connect the power cord to the rear-panel AC inlet, and then connect the power plug to an outlet that has a ground terminal.**

# Using the Protection Cover

When the product is shipped from the factory, a protection cover is attached to the front panel. This cover prevents unintentional changes to the test conditions. Remove this cover when you want to set the test conditions.

Even when the cover is attached, you can still recall settings from memory, start and stop tests, perform remote operations, and control the TOS5200 through its USB port. If the tester will be used to repeatedly perform tests with fixed conditions, such as when being used as part of a manufacturing line, attach the protection cover to ensure safe operation of the tester. This is useful in preventing incorrect operation of the tester.

If the cover is damaged or lost, contact your Kikusui agent or distributor.

## ■ Removing the protection cover

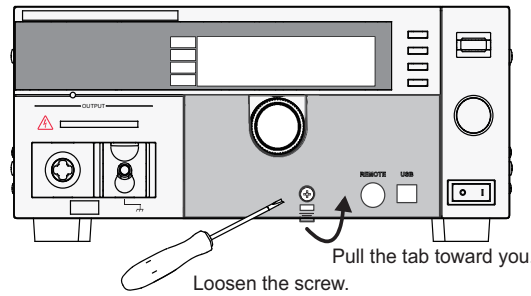

Loosen the screw, and then pull the hook centered at the bottom of the cover towards you to remove the protection cover from the panel.

## ■ Attaching the protection cover

Insert the tabs at the top of the cover into the slots in the panel, push the bottom part of the cover until it is attached to the panel, and then use the screw to fix the cover in place.

## ■ Storing the protection cover

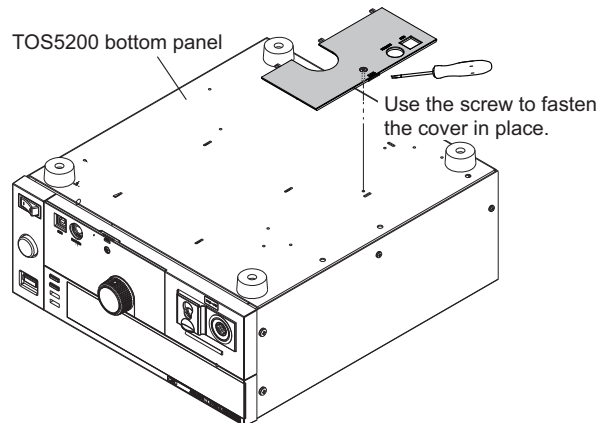

When you want to use the TOS5200 without the protection cover attached, such as when you will repeatedly perform tests with frequently changed test conditions, you can store the protection cover on the product's bottom panel. This is useful in preventing the cover from being lost.

Use the screw to fix the cover to the product's bottom panel.

# Turning the Power On

## Checking indicators and the status of the interlock feature

See p. 59

The first time that you turn the POWER switch on after you purchase the TOS5200, the tester will be in PROTECTION mode through the interlock feature. Connect the included SIGNAL I/O plug to the SIGNAL I/O connector to release the interlock feature.

See p. 59

Only use the included SIGNAL I/O plug to easily release the PROTECTION mode.

When you are actually performing tests, use the interlock feature to ensure safety.

During withstanding voltage test in which you are using tools, (1) placing a cover over the DUT so that output is turned off whenever the cover is removed to prevent electric shock and (2) placing a safety fence around the work area where withstanding voltage test is being performed so that output is turned off whenever the fence is opened are both examples of effective safety measures.

### NOTE

When the TOS5200 is turned on, a self-test is run, and all the indicators on the front panel light. To ensure safety, check that all the indicators light before you use the TOS5200. It is especially dangerous to use the tester if its DANGER LED is broken.

When the power is turned on, the DANGER LED lights, but no voltage is generated.

See p. 20

**1 Check that the power cord and all cables are correctly connected.**

**2 Check that nothing is connected to the SIGNAL I/O connector.**

**3 Press the (|) side of the front-panel POWER switch to turn the TOS5200 on.**

Check that all the front-panel indicators light.

The firmware version screen will be displayed for a few seconds, and then a message indicating that the TOS5200 is in PROTECTION mode will be displayed.

Check that the tester is in PROTECTION mode through the interlock feature.

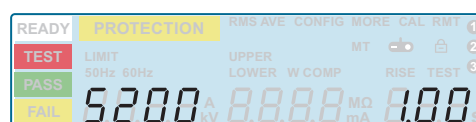

Firmware version screen

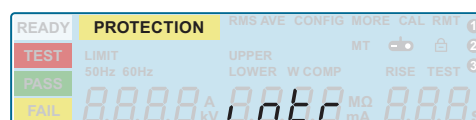

Interlock protection mode

**4 Press the (O) side of the front-panel POWER switch to turn the TOS5200 off.**

## Turning the POWER switch on

- 1 **Connect the included SIGNAL I/O plug to the SIGNAL I/O connector.**  
Connecting the SIGNAL I/O plug will release the interlock feature.
- 2 **Press the (|) side of the POWER switch to turn the TOS5200 on.**
- 3 **Check the firmware version (Ver x.xx) that is displayed on the screen.**  
Check that the firmware version screen is displayed for a few seconds, that the setup screen for setting the withstanding voltage test conditions is displayed thereafter, and that the tester is then in READY mode (that the READY LED lights).

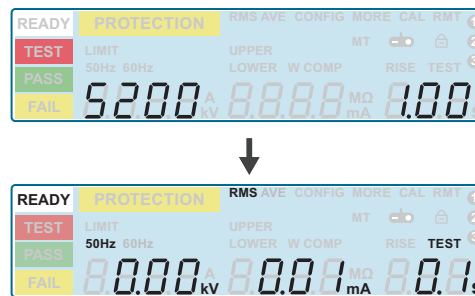

Firmware version 1.00 display example

See p. 72

The first time that the POWER switch is turned on, the firmware version is displayed, and then the setup screen for setting the withstanding voltage test conditions is displayed (with the factory default settings).

The product stores the settings that are in use before it is turned off, so the next time that the POWER switch is turned on, the TOS5200 starts with these settings.

## Turning the POWER switch off

**Press the (O) side of the POWER switch to turn the TOS5200 off.**

The panel settings that were in use immediately before the POWER switch was turned off are saved. If the POWER switch is turned off immediately after the settings have been changed, the last settings may not be stored.



**Risk of electric shock.**

- After you turn the POWER switch off, wait at least 10 seconds before you turn the POWER switch back on. It is dangerous to do otherwise, because the protective features of the product may not work effectively.  
This may cause the product to malfunction, and it may reduce the life of the POWER switch and internal parts such as the fuses.
- Except in an emergency, do not turn the POWER switch off while output is being generated.

# Connecting to the Device under Test (DUT)



**WARNING**

Risk of electric shock. During testing (while the TEST LED or DANGER LED is lit), never touch the HIGH VOLTAGE terminal, test leads, and DUT.

## Using test leads



**WARNING**

Risk of electric shock.

- Parts of the included test leads near the alligator clips protrude from the vinyl insulation when the wires are connected. These parts are dangerous. Never come close to these parts during testing.
- If connections are incomplete, the entire DUT may be charged to a high voltage. This is dangerous, so be sure to connect the DUT correctly.
- Be sure to connect the low-voltage test lead (black) first.

Never come close to this area during testing.

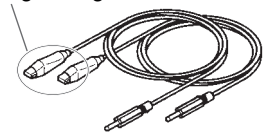

- 1 Check that the POWER switch is off and that the DANGER LED is off.

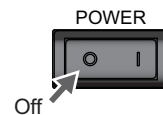
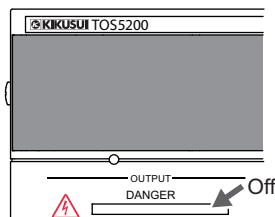

See p. 62

- 2 Check that there are no tears or breaks in the test lead insulation.

- 3 Raise the front-panel LOW VOLTAGE terminal's cable lock, and then connect the low-voltage test lead (black).

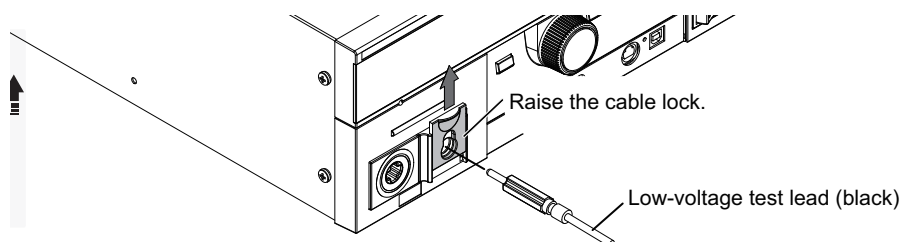

- 4 Lower the cable lock to secure the lead in place.

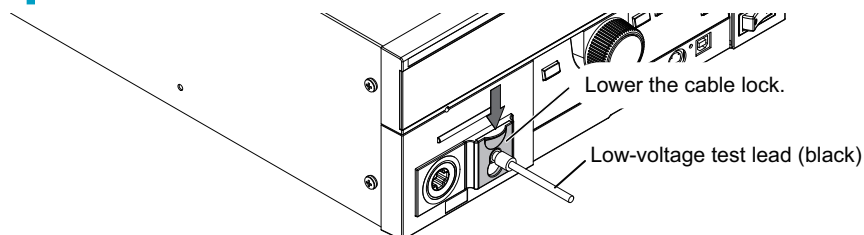



- 5 Connect the low-voltage test lead (black) to the DUT.
- 6 Connect the high-voltage test lead (red) to the DUT.
- 7 Connect the high-voltage test lead (red) to the front-panel HIGH VOLTAGE terminal.

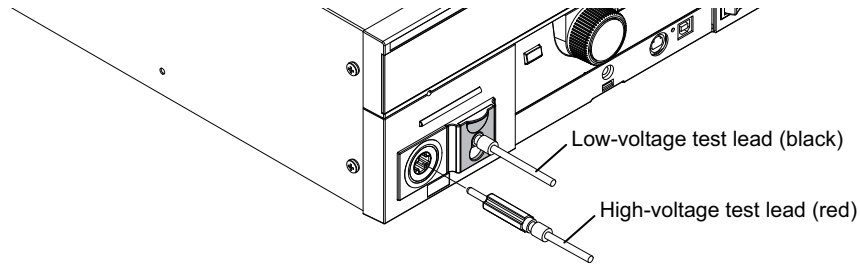

- 8 Check that the DANGER LED is turned off.

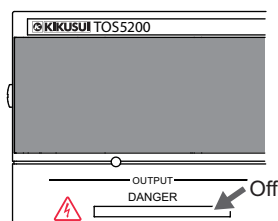

## Reducing the effect of noise

Noise may be generated if the outputs are shorted or if the DUT insulation is damaged. Electronic devices in the surrounding area may malfunction due to the effect of this noise. To reduce the effect of noise, connect a toroidal core or a resistor of approximately  $470\ \Omega$  between the tips of the high- and low-voltage test leads and the DUT. Connect the toroidal core or resistor as close to the DUT as possible.

If you are connecting a toroidal core, it is effective to wrap the test leads two to three times around a type of core that can be snapped on and that is often used with power cables. This type of core is usually approximately 20 mm in diameter.

If you are connecting a resistor, pay close attention to the power rating of the resistor. When the upper limit is 10 mA or less, connect a resistor of approximately  $470\ \Omega$  (3 W, 30 kV impulse withstanding voltage). Because this resistor causes the voltage to fall, the voltage that is actually applied to the DUT is slightly lower than the voltage that is generated from the product's output terminals (when a 10 mA current flows, the voltage falls approximately 10 V). These methods are extremely useful in reducing the effect of noise.

Connect the toroidal core or resistor as close to the DUT as possible.

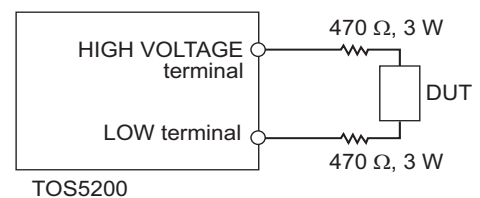
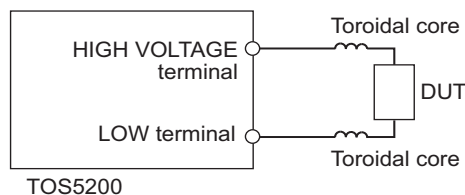

## Using the optional high voltage test probe (model HP01A-TOS/HP02A-TOS)

---

 p. 17

If you use the optional test probe instead of the test leads, you can use hands-on control to start tests. For details, see the "OPERATION MANUAL HIGH VOLTAGE TEST PROBE HP01A-TOS/HP02A-TOS."

## Disconnecting test leads from the DUT

---

- 1** Check that the **POWER** switch is off and that the **DANGER LED** is off.
- 2** Disconnect the high-voltage test lead (red) from the front-panel **HIGH VOLTAGE** terminal.
- 3** Disconnect the high-voltage test lead (red) from the DUT.
- 4** Disconnect the low-voltage test lead (black).  
You can disconnect the low-voltage test lead (black) first from either the DUT or the TOS5200.



# 3

---

## Safety Precautions for Testing

This chapter describes the precautions that must be followed to perform tests safely.

# Pre-Test Inspection



## WARNING

### Risk of electric shock.

- During testing, this product supplies a voltage of at least 5 kVac to an external device. Handling this tester improperly may lead to a fatal accident. To prevent accidents, strictly follow the precautions and always pay the utmost attention to safety concerns when you operate the TOS5200.
- This product conforms to IEC Safety Class I (equipment that has a protective conductor terminal). Be sure to earth ground the product to prevent electric shock.
- The product is grounded through the power cord ground wire. Connect the protective conductor terminal to earth ground.
- During testing, be sure to wear rubber gloves for electrical work.

Check the following items before you start testing, and always follow the precautions.

- The power cord is connected to a properly grounded outlet.
- There is no damage such as tears or breaks in the test lead insulation.
- When the POWER switch is turned on, the DANGER LED and the status indicators light.
- During testing, do not touch the items that are charged to a high voltage: the DUT, the test leads, and the areas near the output terminals.
- During testing, do not turn the POWER switch off except in an emergency.

# Testing Precautions

During testing, the TEST and DANGER LEDs light. When these LEDs are lit, the TOS5200 is generating a high voltage. During testing, be sure to wear rubber gloves for electrical work. If obtaining these gloves is difficult, contact your Kikusui agent or distributor.

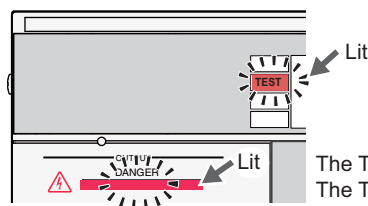

The TEST and DANGER LEDs light.  
The TEST LED lights in red.

# Remote Control Precautions

When you are controlling the TOS5200 remotely, external signals are used to turn the high voltage on and off. To prevent accidents, follow the safety measures given below.

- **Make sure that high voltages are not generated unintentionally.**
- **Make it impossible to touch the DUT, test leads, test probes, and the areas near the output terminals when high voltages are being generated.**

# Interrupting Testing or Operations

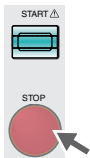

Before you change test conditions or other settings, press the STOP switch, and then be sure to check the following items to ensure safety. If you will not use the product for some time or if the operator will be away from the product, be sure to turn the POWER switch off.

- **The TEST and DANGER LEDs are both off.**

# Emergency Measures

There are two actions that you must carry out if, due to a malfunction in the product or the DUT, there is a possibility of an emergency occurring such as electric shock or damage to the DUT.

- **Turn the POWER switch off.**
- **Remove the power cord plug from the outlet.**

Turn the POWER switch off.

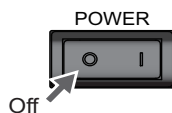

Remove the power plug from the outlet.

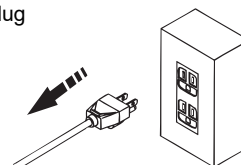

# Forbidden Actions

## Turning the power on and off repeatedly

After you turn the POWER switch off, wait for at least 10 seconds before you turn it back on. It is dangerous to do otherwise, because the protective features of the product may not work effectively. This may cause the product to malfunction, and it may reduce the life of the POWER switch and internal parts such as the fuses.

# About Malfunctions



### Risk of electric shock.

- Until you get the product fixed, make sure that nobody can use it.
- For repairs, contact your Kikusui agent or distributor.

If the TOS5200 is in one of the states explained below, it may be malfunctioning in a very dangerous manner—it may not be possible to turn off the high voltage that is being generated. If the tester is not operating properly, it may be generating a high voltage irrespective of the settings made by the operator.

Immediately turn the POWER switch off, and disconnect the power cord from the outlet. Stop using the product immediately, and contact your Kikusui agent or distributor.

- Even when you press the STOP switch, the DANGER LED remains lit.
- During tests, the DANGER LED does not light.

# To Use the Product for a Long Time Free of Malfunctions

Taking size, weight, and cost into consideration, the heat dissipation capability of the voltage generator that is used for withstanding voltage tests has been designed to be one half that of the rated output. Use the TOS5200 within the following limits. If you use the product in a manner that exceeds these limits, the output section may overheat, and the internal protection circuits may be activated. If this happens, stop testing, and wait until the TOS5200 returns to its normal temperature.

### ■ Output limits during withstanding voltage testing

Ambient temperature	Upper limit	Pause time	Output time
$t \leq 40\text{ }^{\circ}\text{C}$	$50\text{ mA} < i \leq 110\text{ mA}$	Greater than or equal to the output time	30 min. max.
	$i \leq 50\text{ mA}$	Not necessary	Continuous output possible

(Output time = voltage rise time + test time + voltage fall time)



# 4

---

## Panel Operation Basics

This chapter describes how to select items on the screen and how to enter values.

# Parts of the Screen

The screen that is used to set the basic test conditions is made up of the four parts shown below.

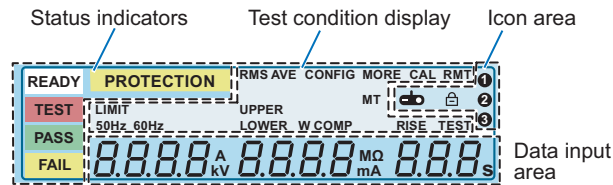

See p. 72

To reset the TOS5200 to the factory default settings, hold down SHIFT, and turn the POWER switch on.

## Status indicators

These display the status.

Display	Description
READY	Lights when the TOS5200 is ready to perform a test
TEST	Lights when a test is being performed
PASS	Lights when a test result is success
FAIL	Lights when a test result is fail
PROTECTION	Lights when a protection function is activated

## Test condition display



This displays test conditions.

Display	Description
RMS	Lights when the measurement mode is true rms response
AVE	Lights when the measurement mode is mean-value response
CONFIG	Lights when CONFIG items are displayed
MORE	Lights when items other than CONFIG items are displayed
CAL	Lights during calibration
RMT	Lights when the TOS5200 is being remotely controlled
LIMIT	Lights when a limit voltage is set
50 Hz	Lights when the frequency is 50 Hz
60 Hz	Lights when the frequency is 60 Hz
UPPER	Lights when the ammeter is displaying the upper limit.
LOWER	Lights when the ammeter is displaying the lower limit.
W COMP	Lights during lower limit judgment
RISE	Lights when the voltage rise time is displayed
TEST	Lights when the test time is displayed



## Icon area

The TOS5200 status is displayed using icons or characters.

Display/icon	Status	
	Model RC01-TOS/RC02-TOS remote control box connected	<a href="#">See</a> <i>p. 16</i>
	Keys locked	<i>p. 36</i>
	Recalled memory number or CONFIG setup screen number	<i>p. 37</i>

## Data input area

This area is used to enter the test voltage, limit voltage, upper and lower current limits, test time, CONFIG values, and additional test items.

The selected item blinks.

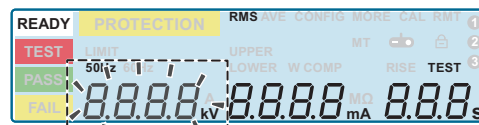

The selected item (blinking)

# Panel Operations

## Switching screens

### ★ Memo

The screen that first appears when the POWER switch is turned on is referred to as the basic setup screen.

See p. 42

See p. 44 , p. 46

On the TOS5200, you need to change the setup screen depending on the item you want to set.

From the basic setup screen, you can switch to the additional test conditions setup screen or CONFIG setup screen.

To display the setup screen for additional test conditions, press MORE.

To display the CONFIG setup screen, press CONFIG (SHIFT+FUNCTION).

Press once to show the CONFIG ① screen and twice to show the CONFIG ② screen.

To return to the basic setup screen, press STOP.

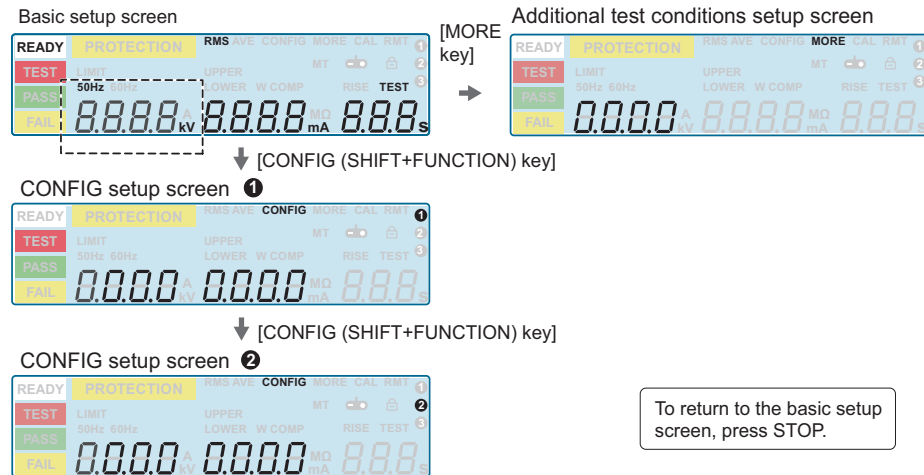

To recall a memory entry, press MEMORY 1, MEMORY 2, or MEMORY 3. To save, press Recall while holding down SHIFT.

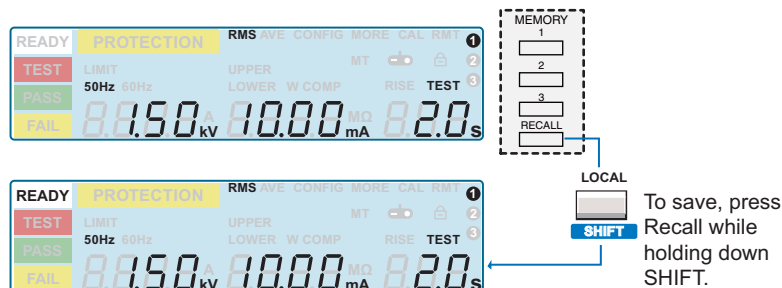

## Selecting items

 p. 41

To select an item, use the SET, UPR/LWR, or TEST key.

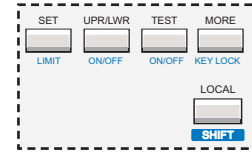
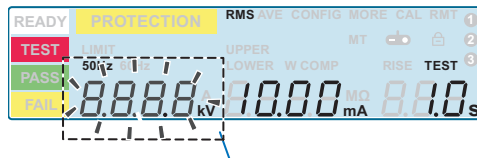

On the basic setup screen, press SET to select the voltage.  
Example: Selecting the voltage (blinking)

If the item that you want to select is not displayed, press LIMIT (SHIFT+SET), ON/OFF (SHIFT+UPR/LWR), ON/OFF (SHIFT+TEST), or press MORE key.

On the basic setup screen, hold down SHIFT and press SET to select the limit voltage.  
Example: Selecting the limit voltage (blinking)

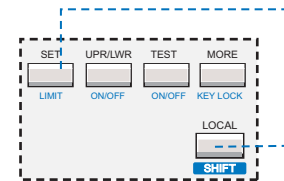
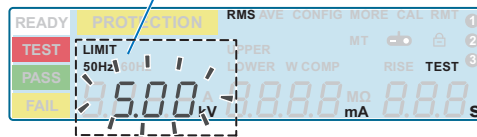

When you enter the setup screen for additional test conditions (MORE) or a CONFIG setup screen, the MEMORY 2 and MEMORY 3 keys become left and right movement keys.



 p. 42

Example: Selecting the frequency (blinking)

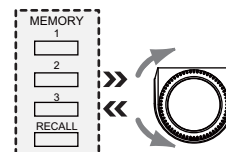
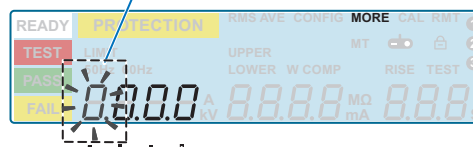

## Entering values

You can set the value of the blinking item by turning the rotary knob.

Turn the rotary knob to set the value.

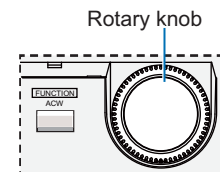
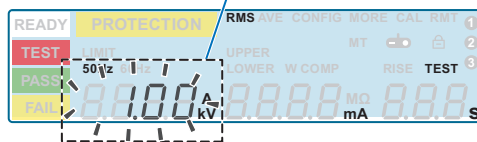

If you hold down SHIFT and turn the rotary knob, you can change the setting resolution. While you hold down SHIFT, the values change quickly.

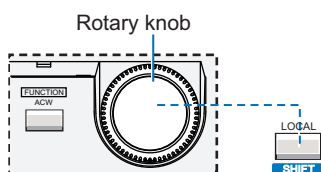



## Locking panel operations (key lock)

The key lock feature can be used to prevent changes to the test conditions due to incorrect operations.

To lock the panel operations, press KEY LOCK (SHIFT+MORE).

In this state, only the START and STOP switches are enabled.

When keys are locked, the key lock icon  appears on the screen. If you try to use a locked key, the key lock icon () blinks for approximately 2 seconds.

To release the key lock, hold down KEY LOCK (SHIFT+MORE) until the key lock icon  disappears.

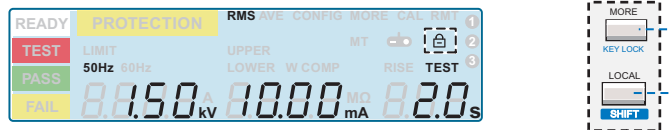

See p. 21

If you will run tests using conditions that you have recalled from memory, we recommend that you use the protection cover.

## Talk mode

This feature enables you to control the product in the same manner as remote control without using commands from a PC. It can reduce processing on the PC.

If you turn talk mode on, you cannot control the product from a PC. To control the product from a PC, turn talk mode off.

For details on talk mode, see the communication interface manual.

# Panel Memory

You can save up to three sets of test conditions (the test conditions currently being used) to internal memory.

## Test conditions and values that can be saved

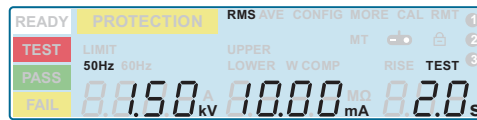

Test voltage	0.00 kV to 5.50 kV
Output frequency	50 Hz/ 60 Hz
Upper limit	0.01 mA to 110 mA
Lower limit	OFF/ 0.01 mA to 110 mA
Test time	OFF/ 0.1 s to 999 s
Voltage rise time	0.1 s to 10.0 s
Voltage fall time	OFF/ 0.1 s
Start voltage	OFF/ 50 %

## Initial panel memory settings

Initially, memory numbers 1 to 3 contain withstanding voltage test conditions. Feel free to use these test conditions if they match the tests that you want to perform.

For details on the test conditions that are initially contained in memory, see "Default panel memory values".

See p. 73

## Saving test conditions

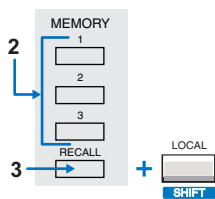

- 1 Display the basic setup screen, and then set the test conditions.
- 2 Press MEMORY 1, MEMORY 2, or MEMORY 3 to select the memory number (1 to 3) in which you want to save the current test conditions.  
The selected memory number blinks.
- 3 Press SHIFT+RECALL to save the conditions in the selected memory number.

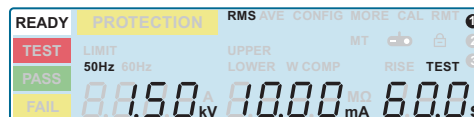

Example of saving to memory number 1

After the test conditions have been saved, the basic setup screen is displayed in READY mode (the READY LED lights).

## Recalling test conditions

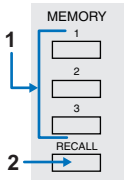

### 1 Press MEMORY 1, MEMORY 2, or MEMORY 3 to specify the memory number (1 to 3) from which you want to recall test conditions.

The test conditions that are saved in the memory number (1 to 3) that you specified are displayed.

### 2 Press RECALL to recall the test conditions that are saved in the specified memory number.

The basic setup screen is displayed, and the icon corresponding to the memory number is displayed in the icon area. The TOS5200 is now set to the recalled test conditions.

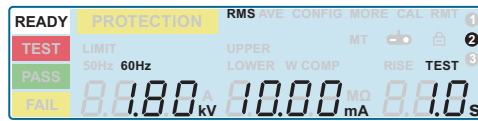

Example: The test conditions that were saved in MEMORY 2 have been recalled.

If you change the recalled test conditions, the memory number disappears. Even if you set the test conditions back to the values that are stored in memory, the memory number will not reappear.



# 5

---

## Withstanding Voltage Test

This chapter explains withstanding voltage test, from how to set the test conditions to how to save test results.

# About Judgment

The TOS5200 judges whether a test results in PASS, L-FAIL, or U-FAIL on the basis of the limits that are set in advance.

Judgment result	Description	Display	Buzzer
PASS	When the test time elapses (TIMER is 0 seconds), if the condition "lower limit < measured value < upper limit" is true, the judgment result is PASS, and the test ends.	PASS LED lights in green. Measured value remains displayed for the length of time specified by Pass Hold.	Sounds for 50 ms. <sup>1</sup>
L-FAIL	If the condition "lower limit ≥ measured value" is true, the judgment result is LOWER, and the test is immediately stopped.	FAIL LED (yellow) and "LOWER" lights.	Sounds until STOP is pressed.
U-FAIL	If the condition "upper limit ≤ measured value" is true, the judgment result is UPPER, and the test is immediately stopped.	FAIL LED (yellow) and "UPPER" lights.	

1 The length of time that the buzzer sounds when a PASS judgment occurs is fixed to 50 ms. The specified Pass Hold time has no effect.

## Effectiveness of the lower limit

Normally, even a good DUT will have a certain degree of leakage current. Setting the upper limits just within the boundaries of the characteristic range of the DUT is useful in detecting breaks in the test leads and poor connections, enabling you to perform highly reliable testing. In withstanding voltage tests, you can perform tests effectively by enabling the lower limit with W COMP.

## Invalid Settings

If you specify an invalid value for a setting, a message blinks on the screen. While a message is blinking, the READY LED turns off, and you cannot start a test. You also cannot select other items.

Specify a valid value.

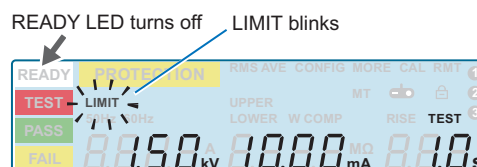

Example of LIMIT indicator blinking

Message	Description
mA indicator blinking	When the lower or upper limit is turned on, and the upper limit has been set lower than the lower limit.
LIMIT indicator blinking	When you try to set the test voltage higher than the set limit voltage.
kV and mA indicators blinking simultaneously	When the test voltage and the upper limit are set in the withstanding voltage test settings such that their product exceeds 550 VA.



# Setting Test Conditions

Test condition	Panel operation
<b>Basic item</b>	
Test voltage (Voltage)	SET key, rotary knob
Limit voltage (LIMIT)	LIMIT (SHIFT+SET) key, rotary knob
Upper limit (UPPER)	UPR/ LWR key, rotary knob
Lower limit (LOWER)	UPR/ LWR key, rotary knob
on/ off	ON/ OFF (SHIFT+UPR/ LWR) key
Test time (TEST)	TEST key, rotary knob
on/ off	ON/ OFF (SHIFT+ TEST) key
Voltage rise time (RISE)	TEST key, rotary knob
<b>Additional items</b>	
Test voltage frequency (Frequency)	MORE key, rotary knob
Start voltage (Start Voltage)	MORE key, rotary knob
Voltage fall time (Fall Time)	MORE key, rotary knob
Voltage/current measurement mode (Measurement)	MORE key, rotary knob

See p. 31

For details on how to select settings and enter values, see “Panel Operation Basics”.

See p. 24

For details on how to connect the TOS5200 to the DUT, see “Connecting to the Device under Test (DUT)”.

See p. 40

For details on the LOWER and UPPER settings, see also “About Judgment”.

## Test conditions (basic items)

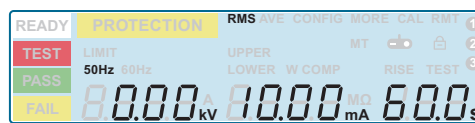

### Test voltage (Voltage)

Sets the test voltage. You cannot specify a voltage that is greater than or equal to the limit voltage.

Test voltage	0.00 kV to 5.50 kV
--------------	--------------------

### Limit voltage (LIMIT)

Sets the limit voltage. This prevents an unnecessarily high voltage from being applied to the DUT because of incorrect operations of the TOS5200.

Limit voltage	0.00 kV to 5.50 kV
---------------	--------------------

### Upper limit (UPPER)

Sets the upper current limit that is used in judgments. If a current that is greater than or equal to the upper limit is measured, a U-FAIL judgment occurs.

Upper limit	0.01 mA to 110 mA
-------------	-------------------

### Lower limit (LOWER)

Sets the lower current limit that is used in judgments. While LOWER is on, if a current that is less than or equal to the lower limit is measured, an L-FAIL judgment occurs.

You can turn on and off the lower limit function using the ON/OFF (SHIFT+UPR/LWR) key.

Lower limit	0.01 mA to 110 mA
-------------	-------------------

### Test time (TEST)

Set the test time. The test time begins when the voltage rise time elapses and ends when the specified time elapses.

You can turn on and off the test time using the ON/OFF (SHIFT+TEST) key.

If the test time is set to off, PASS judgment is not performed.  
Press STOP to stop testing.

Test time	0.1 s to 999 s
-----------	----------------

### Voltage rise time (RISE)

Separate from the test time, you can set the time that the TOS5200 takes to raise the voltage to the test voltage.

Voltage rise time	0.1 s to 10.0 s
-------------------	-----------------

## Test conditions (additional items)



Press MORE to display the items that are not displayed.

Example: Selecting the frequency (blinking)

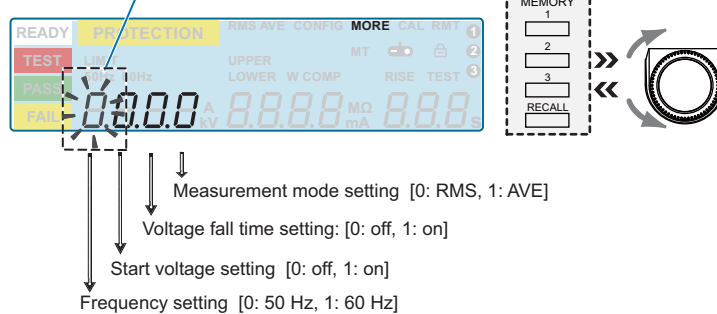

### ★ Memo

On the More screen, use the MEMORY 2 and MEMORY 3 keys to move between settings. Each time you press one of these keys, the cursor moves to the next setting. After selecting a setting, use the rotary knob to set its value.

- 1 Press MORE to display the More Test Conditions setup (More) screen.
- 2 Press MEMORY 2 or MEMORY 3 to move to the item that you want to set, and then use the rotary knob to set the value.

Press STOP key to exit the More Test Conditions setup screen. Return to the basic setup screen.

## Frequency

Sets the test voltage frequency.

50 Hz (0)	The test voltage frequency is set to 50 Hz (factory default setting).
60 Hz (1)	The test voltage frequency is set to 60 Hz.

## Start voltage (Start Voltage)

Separate from the test voltage, you can set the start voltage of withstanding voltage tests. You can set the start voltage to 50 % of the test voltage. The output voltage reaches this value approximately 0.1 seconds after the start of testing.

off (0)	The start voltage is not set (factory default setting).
on (1)	The start voltage is set to 50 % of the test voltage.

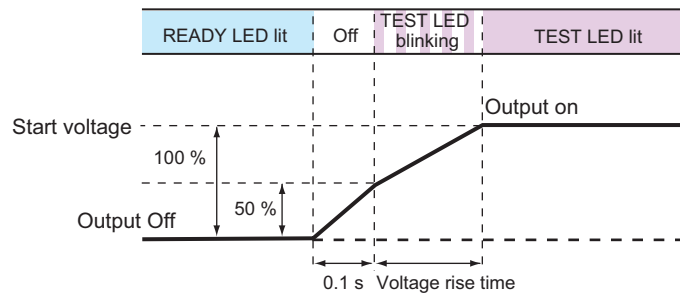

## Voltage fall time (Fall Time)

Separate from the test time, you can set the time that the TOS5200 takes to lower the voltage after a withstanding voltage test ends. This setting is used only when a PASS judgment occurs.

off (0)	The output voltage is shut off immediately after a test ends with a PASS judgment (factory default setting).
on (1)	The output voltage falls over approximately 0.1 seconds after a test ends with a PASS judgment.

## Measurement mode (Measurement)

Selects the voltage/current measurement mode.

RMS (0)	Measurement is performed using true rms response (factory default setting).
AVE (1)	Measurement is performed using mean-value response.

### NOTE

The measurement mode on Kikusui TOS9200 series, TOS8870A, TOS8850, TOS8850A, TOS5000 series, and TOS5000A series is mean-value response.

# CONFIG Settings

CONFIG settings are provided on the CONFIG ❶ screen and CONFIG ❷ screen.

CONFIG 1		CONFIG 2	
Double Action	Double action feature	H.V ON	Output when there is residual voltage or during testing
Momentary	Momentary feature	Test	Output during testing when the test voltage is at the set value
Fail Mode	Fail mode feature	Pass	PASS judgment output
Pass Hold	PASS judgment result hold time	Upper Fail	Output when upper limit judgment is FAIL
Pass	Buzzer volume level for PASS judgment	Lower Fail	Output when lower limit judgment is FAIL
Fail	Buzzer volume level for FAIL judgment	Ready	Output when READY is displayed
Baudrate	RS232C baud rate	Protection	Output during PROTECTION mode
Talk Mode	Talk mode	Power ON	Output when the POWER switch is on

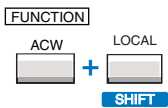

- 1 Press CONFIG (SHIFT+FUNCTION) to display the CONFIG setup screen.**  
Press once to show the CONFIG ❶ screen and twice to show the CONFIG ❷ screen.
- 2 Press MEMORY 2 or MEMORY 3 to move to the CONFIG item that you want to set, and then use the rotary knob to set the value.**

To exit from the CONFIG setup screen and return to the basic setup screen, press STOP.

If you enter CONFIG settings again without first turning the power off, the screen that you previously were viewing will be displayed.

## ★ Memo

The first screen that is displayed when you perform configuration settings is called CONFIG setup screen.

## CONFIG 1 settings

On the CONFIG ❶ setup screen, you can set the test mode and buzzer volume level.

Example: Selecting the double action feature (blinking)

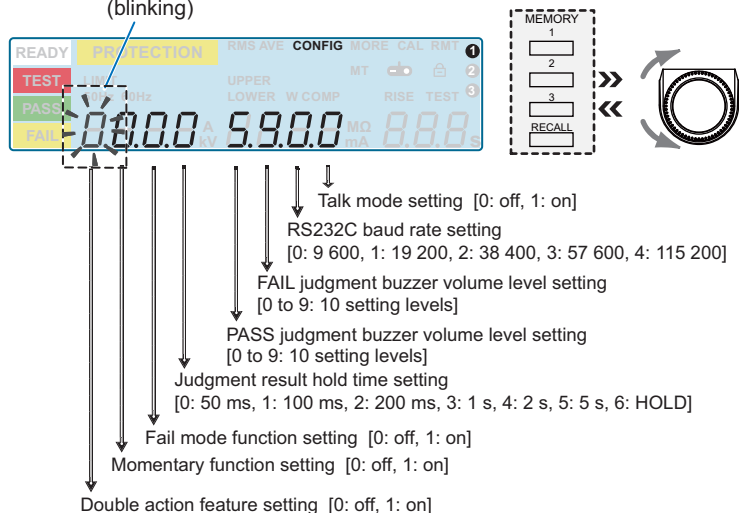

## Double action feature

This feature enables you to start a test by first pressing STOP and then pressing START within 0.5 seconds. If you do not press START within this time limit, the test does not start (the READY LED turns off). This feature ensures that tests are started safely because it requires you to use both the STOP and START switches.

off (0)	The double action feature is turned off (factory default setting).
on (1)	The double action feature is turned on.

## Momentary feature

This feature enables you to perform tests only while you are pressing START. This ensures safe testing because it means that your hand must be fixed to the panel or to an optional RC01-TOS START switch. While this feature is on, testing stops as soon as you release START. The stop operation is the same as if you had pressed STOP.

Using this feature with the optional RC02-TOS (two-hand-type remote control box [See p. 16](#)) provides an even higher level of safety.

off (0)	The momentary feature is turned off (factory default setting).
on (1)	The momentary feature is turned on.

## Fail mode feature

This feature prevents FAIL judgments and protection modes from being cleared even when a stop signal is sent with a command. To clear the FAIL judgment when the fail mode feature is turned on, press STOP on the front panel.

If you are using the optional high voltage test probe (HP01A-TOS/HP02A-TOS [See p. 17](#)), we recommend that you turn on the fail mode feature. When a test ends with a FAIL judgment or ends in protection mode, the FAIL judgment is not cleared even if you let go of the probe. Thus, you can definitely check the status.

off (0)	The fail mode feature is turned off (factory default setting).
on (1)	The fail mode feature is turned on.

## Judgment result hold time (Pass Hold)

This feature enables you to set the length of time that the TOS5200 maintains a PASS judgment state. If you set Pass Hold to HOLD, the measured results remain displayed on the screen until you press STOP. When a FAIL judgment occurs, the FAIL judgment's measured results remain displayed on the screen until you press STOP, regardless of the value of the Pass Hold setting.

50 ms (0) to 5.5 s (5)	0: 50 ms (factory default setting), 1: 100 ms, 2: 200 ms, 3: 1 s, 4: 2 s, 5: 5 s
HOLD (6)	The results are maintained until you press STOP.

## Buzzer volume level for PASS judgment (PASS)

You can set the volume level of the buzzer that is sounded when a PASS judgment occurs.

0 to 9	0, 1, 2, 3 (factory default setting), 4, 5, 6, 7, 8, 9
--------	--

### Buzzer volume level for FAIL judgment (FAIL)

You can set the volume level of the buzzer that is sounded when a FAIL judgment occurs.

0 to 9	0, 1, 2, 3, 4, 5 (factory default setting), 6, 7, 8, 9
--------	--

### RS232C baudrate

You can set the baud rate for the RS232C interface.

9600 (0) to 115200 (4)	0: 9600 (factory default setting), 1: 19200, 2: 38400, 3: 57600, 4: 115200
------------------------	--

### Talk mode

See p. 68

This feature enables you to send test results and the like from the product through the RS232C interface without using commands from a PC. It can reduce processing on the PC.

If you turn talk mode on, you cannot control the product from a PC. To control the product from a PC, turn talk mode off.

off (0)	Talk mode is not used (factory default setting).
on (1)	Talk mode is used.

## CONFIG 2 settings

On the CONFIG 2 setup screen, you can set the output conditions when using the optional warning light unit, PL02-TOS.

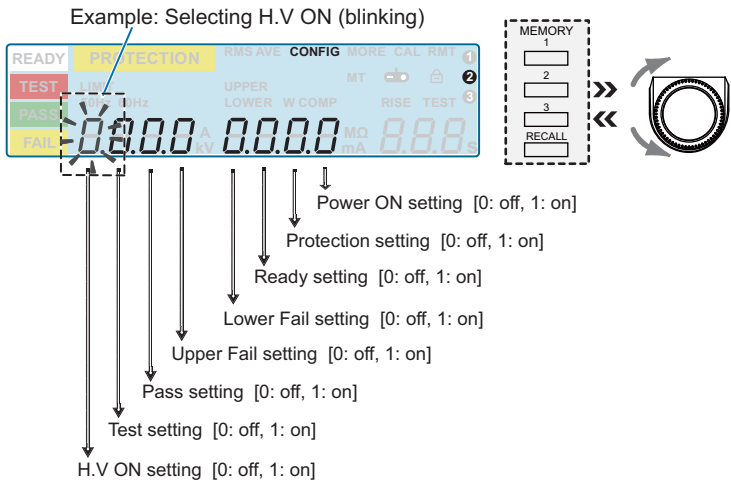

### H.V ON

Sets whether the 24 Vdc output is generated while there is a residual voltage and during testing.

off (0)	The 24 Vdc output is turned off while there is a residual voltage and during testing (factory default setting).
on (1)	The 24 Vdc output is turned on while there is a residual voltage and during testing.

## Test

Sets whether the 24 Vdc output is generated while tests are being performed with the test voltage at the specified voltage value.  
The 24 Vdc output is not generated during voltage rise time (Rise Time) and voltage fall time (Fall Time).

off (0)	The 24 Vdc output is turned off during testing (factory default setting).
on (1)	The 24 Vdc output is turned on during testing.

## Pass

Sets whether the 24 Vdc output is generated after a PASS judgment has occurred.

off (0)	The 24 Vdc output is turned off during testing (factory default setting).
on (1)	The 24 Vdc output is turned on during testing.

## Upper Fail

Sets whether the 24 Vdc output is generated after an upper limit FAIL judgment has occurred.

off (0)	The 24 Vdc output is turned off after an upper limit FAIL judgment occurs (factory default setting).
on (1)	The 24 Vdc output is turned on after an upper limit FAIL judgment occurs.

## Lower Fail

Sets whether the 24 Vdc output is generated after a lower limit FAIL judgment has occurred.

off (0)	The 24 Vdc output is turned off after a lower limit FAIL judgment occurs (factory default setting).
on (1)	The 24 Vdc output is turned on after a lower limit FAIL judgment occurs.

## Ready

Sets whether the 24 Vdc output is generated while the READY LED is lit.

off (0)	The 24 Vdc output is turned off while the READY LED is lit (factory default setting).
on (1)	The 24 Vdc output is turned on while the READY LED is lit.

## Protection

Sets whether the 24 Vdc output is generated while the TOS5200 is in protection mode.

off (0)	The 24 Vdc output is turned off when the TOS5200 is in protection mode (factory default setting).
on (1)	The 24 Vdc output is turned on when the TOS5200 is in protection mode.

## Power ON

Sets whether the 24 Vdc output is generated while the POWER switch is on.

off (0)	The 24 Vdc output is turned off when the POWER switch is turned on (factory default setting).
on (1)	The 24 Vdc output is turned on when the POWER switch is turned on.

# Starting a Test



**WARNING** Risk of electric shock. During testing, do not touch the test leads and the DUT.

## To start a test

- 1 Check that the TOS5200 is correctly connected to the DUT.
- 2 When the READY LED lights in white, press START.



See p. 49

If the test does not start, see “If you cannot start testing”.

See p. 65

If you want to start another test after testing finishes, set a wait time between tests as necessary.

## When a test starts

The TEST and DANGER LEDs light. The TEST LED lights in red.

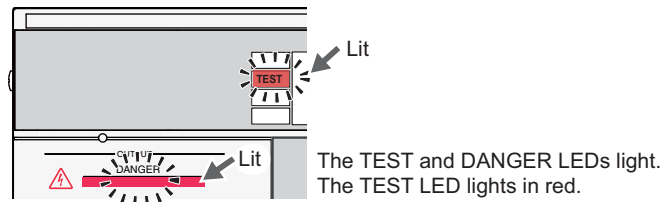

## If the start voltage and the voltage rise time have been set

See p. 42 ,p. 43

After the voltage rises to the start voltage or after the voltage rise time elapses, the TEST LED lights in red, and the test starts. While the voltage is rising, the TEST LED blinks in red, and the display counts up to the set rise time.

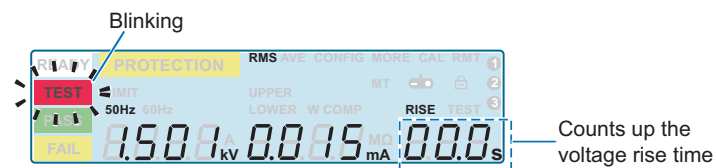



## If the start voltage has been turned off and the voltage rise time has not been set

After 0.1 seconds, the TEST LED lights in red, and the test starts.

## If the test time has been set or if the test time has been turned off

See p. 41 , p. 42

The TEST LED lights in red during testing. If the test time has been turned on, the display counts down from the set test time. If it is set to OFF, the display counts up the test time.

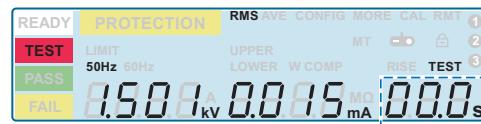

The time display after you start testing differs depending on whether TIMER is set to ON or OFF.

TIMER ON	The timer's remaining test time is counted down.
TIMER OFF	The elapsed test time is counted up. When the test time exceeds 999 seconds, "999" blinks.

## To change the voltage setting during a test

While the TEST LED is lit in red, press SET to select the voltage setting value, and then use the rotary knob to change the value. The voltage is changed immediately.

The changed voltage is immediately applied to the test, but the voltage value on the display shows the measured value. After the test finishes, when the TOS5200 returns to the READY state, the new voltage value is shown on the display.

## If you cannot start testing

In the following conditions, you will not be able to start testing. The READY LED will not light.

See p. 37

- **The memory number is not fixed while panel settings are being recalled from or saved to memory.**

See p. 51 , p. 54

- **STOP is being pressed (including when a STOP signal is being applied to the SIGNAL I/O connector).**

See p. 40

- **"mA" is blinking.**  
The lower or upper limit is turned on, and the upper limit has been set lower than the lower limit. Specify a valid value.
- **"kV" and "mA" are blinking simultaneously.**  
When the test voltage and the upper limit are set in the withstanding voltage test settings such that their product exceeds 550 VA. Specify a valid value.

- **“PASS” or “FAIL” is lit.**

You cannot start testing while a judgment result is displayed. Press STOP to switch the TOS5200 to the READY state.

 p. 74

- **“PROTECTION” is lit.**

If PROTECTION is lit, the TOS5200 has switched to protection mode and will not allow you to start testing. Resolve the issues causing the PROTECTION mode to be on.

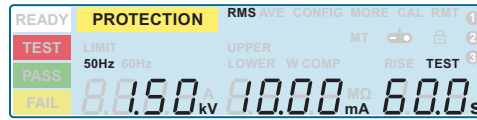

- **The double action feature has been turned on.**

 p. 45

When the double action feature is turned on, you cannot start tests just by pressing START. Press STOP, and then press START within 0.5 seconds.

# Finishing a Test

## To stop a test



Press STOP.

## When a test finishes

A test will stop under one of the following conditions.

- If the test time elapses (when TIMER is set to ON).
- If a current greater than or equal to the upper limit (U-FAIL) or less than or equal to the lower limit (L-FAIL) is measured.
- If you press STOP.

After a test finishes, the DANGER LED turns off, and the high voltage output is turned off.

If a test finishes under condition a or b given above, the judgment result is displayed on the screen.

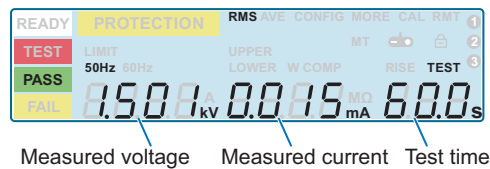

Example: Display of a PASS judgment after testing finished

## If the test time (Timer) has been set

See p. 41, p. 42

After the test time elapses, the PASS LED lights in green, and the test finishes. The PASS LED remains lit in green for the length of time specified by Pass Hold. The READY LED then lights in light white, and the TOS5200 switches to the READY state.

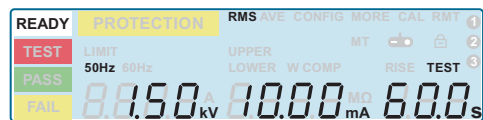

See p. 40

For details on how measured values are judged, see "About Judgment".

The operations that the TOS5200 performs after testing finishes for each judgment condition are shown below.

Operation	PASS	U-FAIL	L-FAIL
Display	PASS LED lights in green. Measured value remains displayed for the length of time specified by Pass Hold.	FAIL LED (yellow) and "UPPER" lights.	FAIL LED (yellow) and "LOWER" lights.
Buzzer	Sounds for 50 ms. <sup>1</sup>	Sounds until STOP is pressed.	
SIGNAL I/O connector	The PASS signal is generated for the length of time specified by the Pass Hold setting.	The U-FAIL signal is generated until the FAIL judgment is cleared.	The L-FAIL signal is generated until the FAIL judgment is cleared.

<sup>1</sup> The length of time that the buzzer sounds when a PASS judgment occurs is fixed to 50 ms. The specified Pass Hold time has no effect.

## To clear judgment results



Press STOP to switch the TOS5200 to the READY state (the READY LED lights).



# 6

---

## External Control

This chapter explains how to use the SIGNAL I/O connector to externally start tests and recall panel memory entries and sequence programs.

# SIGNAL I/O Connector



**WARNING**

**Risk of electric shock. Ensure that all devices are off before you connect or disconnect cables between them.**



**CAUTION**

Risk of damage to the internal circuitry.

- Keep the signal wire at least 500 mm away from the high-voltage test lead and the DUT.
- Do not short the output voltage circuit.
- If you use the TOS5200 with incomplete connections, burn outs caused by heating may occur when the output is turned on.
- Do not touch the contacts or attach insulators to them. Doing so may reduce the quality of the contacts or cause other problems.
- Do not short the +24 V of pin 24 to the chassis or the circuit common.

The SIGNAL I/O connector is the D-sub 25-pin connector on the rear panel.

This connector is used to start and stop tests, recall panel memory entries and test modes, and monitor the status of the TOS5200.

- Connector on the rear panel  
XM3B-2522 D-sub 25-pin female connector (socket), M2.6 x 0.45 screws; manufactured by OMRON Corporation
- Compatible connector (plug)  
D-sub 25-pin male (with fix screw M2.6)

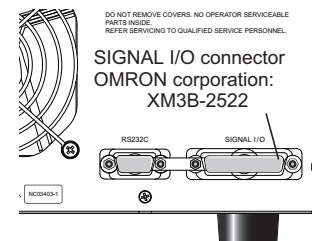

To avoid malfunctions caused by noise, use shielded D-sub 25-pin connectors and a cable that is 2.5 m or less in length.

For information about how to obtain replacement parts, contact your Kikusui agent or distributor.

For information about how to use these components, see the OMRON Corporation catalogs.

## Wire and tool that are necessary to make the connection

Wire	Single wire: 0.32 mm (AWG28) to 0.65 mm (AWG22) in diameter
	Twisted wire: 0.32 mm <sup>2</sup> (AWG22) to 0.08 mm <sup>2</sup> (AWG28)
Wire stripper	A wire stripper that matches the wires listed above

## SIGNAL I/O specifications

Input signal		Output signal	
Low-active control input		Open drain output	
High-level input voltage	11 V to 12 V	Output withstanding voltage	30 Vdc
Low-level input voltage	0 V to 4 V	Output saturation voltage	Approx. 1.1 V at 25 °C
Low-level input current	5 mA max. <sup>1</sup>	Maximum output current	400 mA total
Input time width	5 ms minimum		

<sup>1</sup> Excluding the interlock signal

■ SIGNAL I/O connector pinout

Pin no.	Signal name	I/O	TOS5200																
1	INTERLOCK+	I	If you open the positive and negative terminals, the output is turned off, and the TOS5200 is switched to Protection mode. Open: The resistance between the two terminals is 1.2 kΩ or greater. Short: The resistance between the two terminals is 1 kΩ or less.																
2	PM0	I	Panel memory selection signal. The selection signal is latched on the rising edge of the input strobe signal to recall panel memory.  * The selection of memory is prioritized over TEST SEL and AUTO SEL.																
3	PM1	I																	
				<table border="1"> <thead> <tr> <th>PM0</th> <th>PM1</th> <th>Recalled panel memory number</th> </tr> </thead> <tbody> <tr> <td>H</td> <td>H</td> <td>Memory 1</td> </tr> <tr> <td>L</td> <td>H</td> <td>Memory 2</td> </tr> <tr> <td>H</td> <td>L</td> <td>Memory 3</td> </tr> <tr> <td>L</td> <td>L</td> <td>—</td> </tr> </tbody> </table>	PM0	PM1	Recalled panel memory number	H	H	Memory 1	L	H	Memory 2	H	L	Memory 3	L	L	—
PM0	PM1	Recalled panel memory number																	
H	H	Memory 1																	
L	H	Memory 2																	
H	L	Memory 3																	
L	L	—																	
4	NC	—	—																
5	NC	—	—																
6	NC	—	—																
7	NC	—	—																
8	NC	—	—																
9	STB	I	Panel memory strobe signal input terminal.																
10	TEST SEL	I	NA																
11	AUTO SEL	I	NA																
12	COM	—	Circuit common terminal.																
13	INTERLOCK-	I	If you open the positive and negative terminals, the output is turned off, and the TOS5200 is switched to Protection mode. Open: The resistance between the two terminals is 1.2 kΩ or greater. Short: The resistance between the two terminals is 1 kΩ or less.																
14	HV.ON	O	On during testing and when a voltage remains across the output terminals.																
15	TEST	O	On during testing (excluding when voltage is rising or falling).																
16	PASS	O	On for at least 0.2 seconds (the PASS HOLD time) when a PASS judgment occurs. On continuously when the PASS HOLD time is set to HOLD.																
17	U-FAIL	O	On continuously when an UPPER FAIL judgment occurs because a value greater than or equal to the upper limit is detected.																
18	L-FAIL	O	On continuously when LOWER FAIL results from judgment because a value less than or equal to the lower limit is detected.																
19	READY	O	On when the TOS5200 is waiting (when it is in the READY state).																
20	PROTECTION	O	On when protective features have been activated.																
21	START	I	Start signal input terminal.																
22	STOP	I	Stop signal input terminal.																
23	ENABLE	I	Input terminal for the start signal's ENABLE signal. If the ENABLE signal changes, the TOS5200 is switched to Protection mode.																
24	+24 V	—	+24 V internal power supply output terminal; maximum output current 100 mA.																
25	COM	—	Circuit common terminal.																

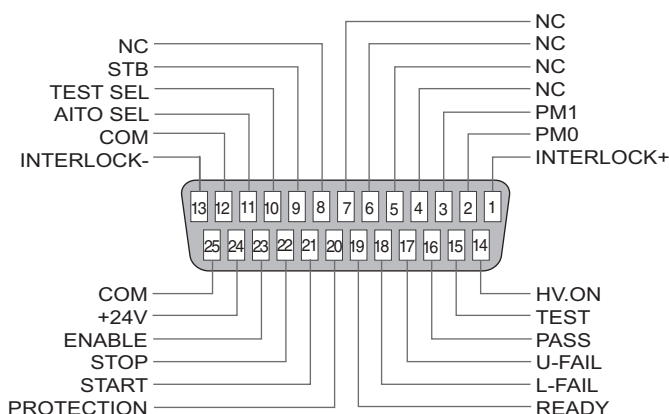

## Internal construction

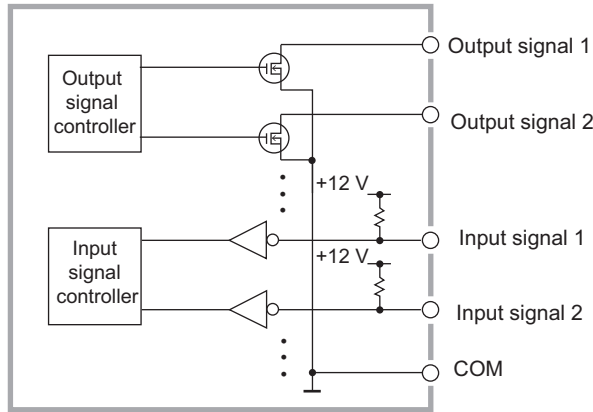

Internal construction of the SIGNAL I/O connector

The input signal circuit and the output signal circuit share the same common.

The input signals are pulled up to +12 V. If the input terminals are opened, the input signal circuit is put into the same state as when a high-level signal is applied.

## Input signal usage example

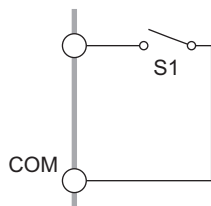

### Using a make contact to control input

Use a make contact, such as a relay or switch, to set the input terminal to low level.

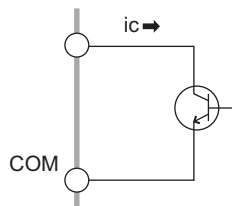

### Using a logic element to control input

Use a logic element, such as a transistor, in place of the switch in the above example.

Design the circuit so that a transistor collector current ( $i_c$ ) of 5 mA or greater flows.



## Output signal usage example

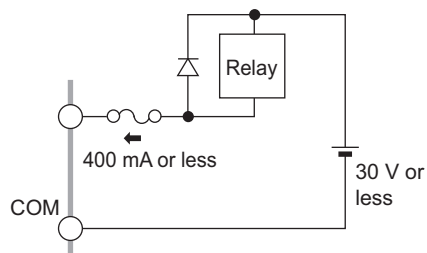

### Driving a relay

Use the output signal to drive a relay.

To improve the safety of the circuit, we recommend that you insert a protection fuse or connect a diode.

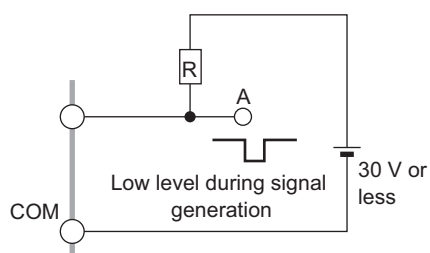

### Obtaining a low-level digital signal

Use the output signal to obtain a low-level digital signal.

## Starting a Test

To use the SIGNAL I/O connector to start a test, set the ENABLE signal to low level. If the ENABLE signal changes, the TOS5200 is switched to Protection mode. Use the STOP signal to clear the Protection mode.

When at least 1 ms has elapsed after the READY signal was set to low level, set the START signal to low level for at least 5 ms. After a valid START signal has been detected, the READY signal is set to high level.

When the ENABLE signal is low, the START signal of the SIGNAL I/O connector is enabled, and the panel's START switch and the START input of the REMOTE terminal are disabled.

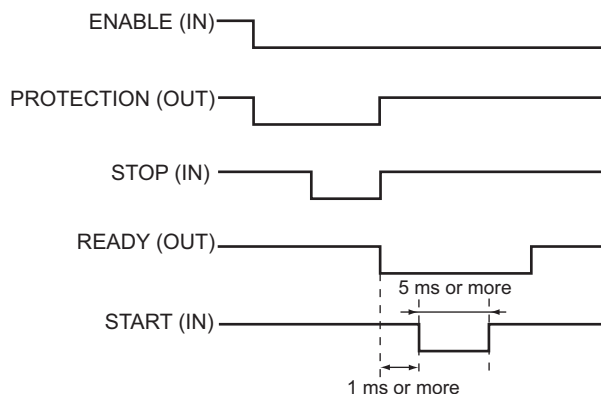

# Recalling Panel Memory and Test Modes

## Selecting the panel memory

The PM and STB signals are processed with the timing shown below. Check that the READY signal is low level.

The relationship between the PM0 and PM1 signals and the panel memory number that is recalled is shown in the table below.

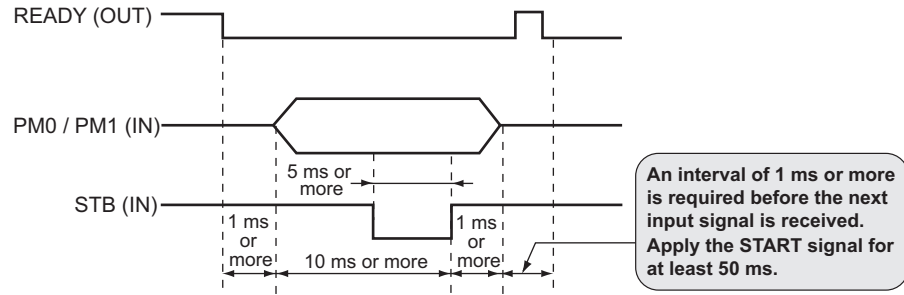

PM0	PM1	TEST SEL	AUTO SEL	Recalled panel memory number
H	H	L	L	Memory 1
L	H	L	L	Memory 2
H	L	L	L	Memory 3
L	L	L	L	—

## Selecting the test mode

The relationship between the PM0, PM1, TEST SEL, and AUTO SEL signals and the test mode that is recalled is shown in the table below.

PM0	PM1	TEST SEL	AUTO SEL	Recalled test mode
L	L	L	L	ACW

# Interlock Feature

This feature links the TOS5200 to an external device to stop output appropriately. This ensures the safety of the operator.

While the interlock feature is active, even if you press the START switch or apply a start signal from an external controller, the TOS5200 will not perform testing. While the interlock signal is being applied, you cannot release PROTECTION mode by pressing the STOP switch or applying a stop signal.

By using the interlock feature, you can control the TOS5200 output from an external source. This ensures safe operation of the tester.

The first time that you turn the POWER switch on after you purchase the TOS5200, the tester will be in PROTECTION mode through the interlock feature. You can use the included SIGNAL I/O plug to easily release the PROTECTION mode.

Attaching the included SIGNAL I/O plug connects pin numbers 1 and 13, the INTERLOCK+ and INTERLOCK- pins. Only use this plug to easily release the PROTECTION mode.

When you are actually performing tests, use the interlock feature to ensure safety.

During withstanding voltage test in which you are using tools, (1) placing a cover over the DUT so that output is turned off whenever the cover is removed to prevent electric shock and (2) placing a safety fence around the work area where withstanding voltage test is being performed so that output is turned off whenever the fence is opened are both examples of effective safety measures.

 p. 22

## ■ Interlock signal input conditions

Open across terminals

- When the resistance across the positive and negative terminals is 1.2 k $\Omega$  or greater.
- If you are using transistors or an optical device, when the current across the positive and negative terminals is 5 mA or less.

## ■ Interlock signal release conditions

Short across terminals

- When the resistance across the positive and negative terminals is 1 k $\Omega$  or less.
- If you are using transistors or an optical device, when the current across the positive and negative terminals is 6 mA or greater.

## How to use the interlock feature

When SIGNAL I/O connector pins 1 and 13 are opened, the interlock feature is enabled. When the pins are shorted, the interlock feature is released.

When the interlock feature is active, the TOS5200 is in PROTECTION mode. To release the interlock feature, connect the included SIGNAL I/O plug to the rear-panel SIGNAL I/O connector. Then press STOP to release PROTECTION mode.

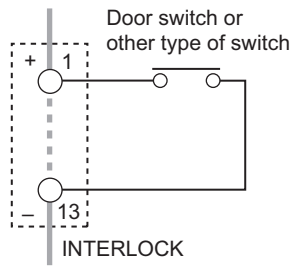

### Using an open/close switch

When the contact is open, the interlock signal also becomes open, and the interlock feature is activated. To release the interlock feature, close the contact, and then press STOP or apply a STOP signal.

Use a door switch or other type of switch that has a voltage rating of 30 Vdc or greater and a current rating of 10 mA or greater.

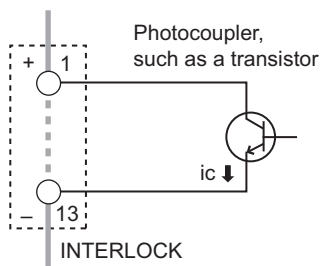

### Using a transistor or optical device

When the transistor collector current is 5 mA or less, the interlock feature is activated. To release the interlock feature, allow an ic of 6 mA or greater to flow, and then press STOP or apply a STOP signal.

## STATUS OUT connector

See p. 17, p. 46

This is the output connector for connecting the optional warning light unit, PL02-TOS.

In CONFIG setting 2, select the status that you want to output. Select H.V ON, Test, Pass, Upper Fail, Lower Fail, Ready, Protection, or Power ON. If you select multiple items, the status that is generated will be the logical sum of the items. When the selected status is true, the TOS5200 generates a +24 Vdc signal.

For details, see the "WARNING LIGHT PL02-TOS OPERATION MANUAL."



# 7

---

## Maintenance

This chapter explains daily inspections such as measurement checks.

# Pre-Test Inspection

## Inspection of test leads and the judgment feature

Allow a current to flow between the HIGH VOLTAGE and LOW VOLTAGE terminals to check the judgment feature. During this inspection, the two test leads are shorted, so you can check for breaks in the test leads at the same time.

We recommend that you perform this pre-test inspection before you use the TOS5200.

The test leads are consumable parts. Check them periodically for tears and breaks.



**WARNING**

**Breaks or tears in the insulation may cause electric shock or fire. If a break or tear is found, stop using the damaged test lead immediately.**

See p. 24

- 1 Short the low-voltage test lead (black) and high-voltage test lead (red).**
- 2 Connect the low-voltage test lead (black) to the LOW VOLTAGE terminal.**
- 3 Connect the high-voltage test lead (red) to the HIGH VOLTAGE terminal.**
- 4 Set the test conditions.**  
Be sure to set the upper limit (UPPER).
- 5 Press START to start a test.**
- 6 If a test results in a U-FAIL judgment, based on this simple check, both the test leads and the TOS5200 judgment feature are working properly.**

See p. 41 , p. 42

If a U-FAIL result does not occur even after you perform this check multiple times, there may be breaks in the test leads. Double-check whether this is the case. If there are no breaks in the test leads, the TOS5200 needs to be repaired.

To have your TOS5200 repaired, contact your Kikusui agent or distributor.

## Calibration

The product is calibrated before shipment. To maintain long-term reliable performance, we recommend periodic calibration.

To have your product calibrated, contact your Kikusui distributor or agent.



# 8

---

## Specifications

This chapter contains the specifications and gives the dimensions of the TOS5200.

Unless specified otherwise, the specifications are for the following settings and conditions.

- The product is warmed up for at least 30 minutes.
- Values indicated by “TYP” are typical values. They are not guaranteed performance values.
- Values indicated by “rdng” are readout values.
- Values indicated by “set” are settings.

## Withstanding voltage tester

		TOS5200									
AC output section	Output range	Output range	0.05 kV to 5.00 kV								
		Setting accuracy	± (2 % of set + 20 V) [at no load]								
		Setting range	0.00 kV to 5.50 kV								
		Resolution	10 V STEP								
	Max. rated output <sup>1</sup>	500 VA (5 kV/100 mA)									
	Max. rated voltage	5 kV									
	Max. rated current	100 mA [output voltage 0.5 kV or higher]									
	Transformer rating	500 VA									
	Output voltage waveform <sup>2</sup>	Sine									
		Distortion	If the output voltage is 0.5 kV or more: 3 % or less (when no load or a pure resistive load is connected).								
	Crest factor	Within $\sqrt{2} \pm 3$ % (output voltage 800 V or higher, at no load)									
	Frequency	50 Hz or 60 Hz									
		Accuracy	±0.5 % (excluding during voltage rise time)								
	Voltage regulation	10 % or less (when changing from maximum rated load to no load)									
	Input line regulation	±0.3 % (5 kV at no load; power supply voltage: 90 V to 250 V)									
Short-circuit current	200 mA or more (output voltage 1.0 kV or higher)										
Output method	PWM switching										
Start voltage	The voltage at the start of withstanding voltage tests can be set to 50 % of the test voltage.										
Limit voltage	The test voltage upper limit can be set. 0.00 kV to 5.50 kV.										
Output voltage monitor feature	If output voltage exceeds the specified value + 350 V or is lower than the specified value - 350 V, output is turned off, and protective features are activated.										
Voltmeter	Digital	Measurement range	0.000 kV to 6.500 kV								
		Display	□.□□□ kV								
		Accuracy	V < 500 V: ± (1.5 % of reading + 20 V), V ≥ 500 V: ±1.5 % of reading								
		Response <sup>3</sup>	True rms/ Mean-value response rms display Can be switched								
		Hold feature	After a test is finished, the measured voltage is held until the PASS or FAIL judgment is cleared.								
Ammeter	Digital	Measurement range	0.00 mA to 110 mA								
		Display	i = measured current <table border="1" style="width: 100%; border-collapse: collapse;"> <tr> <td style="text-align: center;">i &lt; 1 mA</td> <td style="text-align: center;">1 mA ≤ i &lt; 10 mA</td> <td style="text-align: center;">10 mA ≤ i &lt; 100 mA</td> <td style="text-align: center;">100 mA ≤ i</td> </tr> <tr> <td style="text-align: center;">□.□□□ mA</td> <td style="text-align: center;">□.□□□ mA</td> <td style="text-align: center;">□□.□□ mA</td> <td style="text-align: center;">□□□.□ mA</td> </tr> </table>	i < 1 mA	1 mA ≤ i < 10 mA	10 mA ≤ i < 100 mA	100 mA ≤ i	□.□□□ mA	□.□□□ mA	□□.□□ mA	□□□.□ mA
		i < 1 mA	1 mA ≤ i < 10 mA	10 mA ≤ i < 100 mA	100 mA ≤ i						
		□.□□□ mA	□.□□□ mA	□□.□□ mA	□□□.□ mA						
		Accuracy <sup>4</sup>	1.00 mA ≤ i: ± (1.5 % of reading), i < 1.00 mA: ± (1.5 % of reading + 30 μA)								
Response <sup>3</sup>	True rms/ Mean-value response rms display Can be switched										
Hold feature	After a test is finished, the measured current is held until the PASS judgment is cleared.										



		TOS5200				
Judgment feature	Judgment method and judgment operation	Judgment	Judgment method	Display	Buzzer	SIGNAL I/O
		UPPER FAIL	If a current that is greater than or equal to the upper limit is detected, the output is turned off, and an UPPER FAIL judgment occurs.	FAIL LED and "UPPER" lights.	ON	Generates a U-FAIL signal
		LOWER FAIL	If a current that is less than or equal to the lower limit is detected, the output is turned off, and a LOWER FAIL judgment occurs. This judgment is not performed during voltage rise time (Rise Time) of all tests and during the voltage fall time (Fall Time) of withstanding voltage tests.	FAIL LED and "LOWER" lights.	ON	Generates an L-FAIL signal
		PASS	If the specified time elapses without any problems, the output is turned off, and a PASS judgment occurs.	PASS LED lights.	ON	Generates a PASS signal
		<ul style="list-style-type: none"> <li>If PASS HOLD is enabled, the PASS signal is generated continuously until the TOS5200 receives a STOP signal.</li> <li>The UPPER FAIL and LOWER FAIL signals are generated continuously until the TOS5200 receives a STOP signal.</li> <li>The FAIL and PASS buzzer volume levels can be changed.</li> <li>For PASS judgments, the length of time that the buzzer sounds for is fixed to 0.2 seconds. Even if PASS HOLD is enabled, the buzzer turns off after 0.2 seconds.</li> </ul>				
Upper limit setting		0.01 mA to 110 mA				
Lower limit setting		0.01 mA to 110 mA/ OFF				
Judgment accuracy <sup>4</sup>		1.00 mA ≤ i: ± (1.5 % of set), i < 1.00 mA: ± (1.5 % of set + 30 μA)				
Current detection method		Calculates the current's true rms value or mean-value value and compares this value with the reference value				
Calibration		Calibrated with the rms of a sine wave using a pure resistive load				
Time	Voltage rise time	0.1 s to 10.0 s				
	Resolution	0.1 s				
	Voltage fall time	0.1 s/ OFF (only enabled when a PASS judgment occurs)				
	Test time	0.1 s to 999 s, can be turned off (TIMER OFF)				
	Resolution	0.1 s to 99.9 s: 0.1 s. 100 s to 999 s: 1 s.				
	Accuracy	± (100 ppm + 20 ms)				

1 Regarding the output time limits:

Taking size, weight, and cost into consideration, the heat dissipation capability of the voltage generator that is used for withstanding voltage tests has been designed to be one half that of the rated output. Use the TOS5200 within the following limits. If you use the product in a manner that exceeds these limits, the output section may overheat, and the internal protection circuits may be activated. If this happens, stop testing, and wait until the TOS5200 returns to its normal temperature.

Ambient temperature	Upper limit	Pause time	Output time
t ≤ 40 °C	50 mA < i ≤ 110 mA	Greater than or equal to the output time	30 min. max.
	i ≤ 50 mA	Not necessary	Continuous output possible

(Output time = voltage rise time + test time + voltage fall time)

2 Regarding the test voltage waveform:

Waveform distortions may occur if an DUT whose capacitance is dependent on voltage (for example, an DUT that consists of ceramic capacitors) is connected as the load. However, if the test voltage is 1.5 kV, the effect of a capacitance of 1000 pF or less can be ignored.

Because the product's high-voltage power supply uses the PWM switching method, if the test voltage is 500 V or less, the switching and spike noise proportions are large. The lower the test voltage, the greater the waveform is distorted.

3 In either case, true rms or mean-value, a response time of at least 50 ms is required to meet the measurement accuracy.

4 Regarding ammeter and judgment accuracy:

During withstanding voltage tests, current also flows in the stray capacitance of items such as the measurement leads and jigs. This current that flows in the stray capacitances is added to the current that flows in the DUT, and the sum of these currents is measured. Especially if you want to perform judgments with high sensitivity and accuracy, it is necessary to consider methods to limit the current that flows in these stray capacitances, such as by adding upper and lower limits.

Output voltage	1 kV	2 kV	5 kV
When using 350 mm long test leads that are suspended in air (TYP)	2 μA	4 μA	10 μA
When using the accessory, high-voltage test lead TL31-TOS (TYP)	16 μA	32 μA	80 μA

When the humidity is 70 % or higher, add 50 μA.

## Other features

TOS5200	
Test mode	
Double action feature	Tests can only be started by pressing and releasing STOP and then pressing START within 0.5 seconds of releasing the STOP switch.
Length of time to hold a PASS judgment result	You can set the length of time to hold a PASS judgment: 50 ms, 100 ms, 200 ms, 1 s, 2 s, 5 s, or HOLD.
Momentary feature	Tests are only executed while the START switch is held down.
Fail mode feature	This feature enables you to prevent remotely transmitted stop signals from clearing FAIL judgments and PROTECTION modes.
Timer feature	The test ends when the specified time elapses.
Output voltage monitor feature (Volt Error)	If output voltage exceeds "setting + 350 V" or is lower than "setting - 350 V," the TOS5200 switches to PROTECTION mode, output is turned off, and testing finishes.
Memory	Up to three sets of test conditions can be saved to memory.
Key lock	Locks panel key operations (settings and changes).
Protection functions	Under any of the following conditions, the TOS5200 switches to the PROTECTION state, immediately turns output off, and stops testing. PROTECTION on the screen lights.
Interlock Protection	An interlock signal has been detected.
Power Supply Protection	An error was detected in the power supply.
Volt Error Protection	While monitoring the output voltage, a voltage outside of the rated limits was detected. Withstanding voltage test: $\pm 350$ V
Over Load Protection	While monitoring the output power, power exceeding the output power limit was detected. Withstanding voltage test: 550 VA
Over Heat Protection	The internal temperature of the TOS5200 became too high.
Over Rating Protection	The output current was generated for a length of time that exceeds the regulated time.
Remote Protection	A connection to or disconnection from the front-panel REMOTE connector was detected.
SIGNAL I/O Protection	The rear-panel SIGNAL I/O connector's ENABLE signal has changed.
USB Protection	The USB connector has been disconnected, or a defect was detected during remote control operation.

## Interfaces

		TOS5200
USB		USB Specification 2.0 Standard type B socket
RS232C <sup>1</sup>	Hardware	D-SUB 9-pin connector (EIA-232-D compliant) All functions except the POWER switch and key lock
		Baudrate: 9600, 19200, 38400, 57600, 115200 bps
		Transmission system: Start-stop synchronization
	Program message terminator	CR+LF during transmission, CR, LF, or CR+LF during reception
REMOTE		Front-panel 9-pin MINI DIN connector. By connecting an optional device to this connector, you can control the starting and stopping of tests remotely.
SIGNAL I/O		Rear-panel D-sub 25-pin connector
Output specifications	Output method	Open drain output (4.5 Vdc to 30 Vdc)
	Output withstanding voltage	30 Vdc
	Output saturation voltage	Approx. 1.1 V (25 °C)
	Maximum output current	400 mA (TOTAL)
Input specifications <sup>2</sup>	High-level input voltage	11 V to 12 V
	Low-level input voltage	0 V to 4 V
	Low-level input current	5 mA max.
	Input time width	5 ms minimum
1 INTERLOCK+	I	If you open the positive and negative terminals, the output is turned off, and the TOS5200 is switched to Protection mode. Open: If the resistance between the terminals is 1.2 kΩ or greater. Short: If the resistance between the terminals is 1 kΩ or less.
2 PM0	I	Panel memory selection signal. The selection signal is latched on the rising edge of the input strobe signal to recall panel memory.  * The selection of memory is prioritized over TEST SEL and AUTO SEL.
3 PM1	I	
4 NC	—	
5 NC	—	
6 NC	—	
7 NC	—	
8 NC	—	
9 STB	I	Panel memory strobe signal input terminal.
10 TEST SEL	I	NA
11 AUTO SEL	I	NA
12 COM	—	Circuit common terminal.
13 INTERLOCK-	I	If you open the positive and negative terminals, the output is turned off, and the TOS5200 is switched to Protection mode. Open: If the resistance between the terminals is 1.2 kΩ or greater. Short: If the resistance between the terminals is 1 kΩ or less.
14 HV.ON	O	On during testing and when a voltage remains across the output terminals.
15 TEST	O	On during testing (excluding when voltage is rising or falling).
16 PASS	O	On for approximately 0.2 seconds when a PASS judgment occurs. On continuously when the PASS HOLD time is set to HOLD.
17 U-FAIL	O	On continuously when UPPER FAIL results from judgment because a value greater than or equal to the upper limit is detected.

		TOS5200
SIGNAL I/O (continued)		
18 L-FAIL	O	On continuously when FAIL results from judgment because a value less than or equal to the lower limit is detected.
19 READY	O	On when the TOS5200 is waiting (when it is in the READY state).
20 PROTECTION	O	On when protective features have activated (the TOS5200 is in the Protection state).
21 START	I	Start signal input terminal.
22 STOP	I	Stop signal input terminal.
23 ENABLE	I	Start signal enable signal input terminal.
24 +24V	—	+24 V internal power supply output terminal; maximum output current 100 mA.
25 COM	—	Circuit common terminal.
STATUS SIGNAL OUTPUT		Output terminal for a warning light.
	+ Terminal	A +24 V signal is generated from this terminal when output has been turned on.
	COM	+24 V circuit common terminal

1 Talk mode can be set when RS232C is in use.

Talk mode	Description				
0	Responds only to commands from a PC (factory default setting). Automatically responds at the start and end of a test. The TOS5200 status, settings, and measured values are returned.				
1	Response at the start of a test				
	Response at the end of a test				
	<table border="1"> <tr> <td>Status</td> <td>&lt;PASS&gt;, &lt;U_FAIL&gt;, &lt;L_FAIL&gt;, &lt;PROT&gt;, or &lt;ABOUT&gt;</td> </tr> <tr> <td>Settings, measured values</td> <td>Test number, program number, test mode, measured voltage, measured current, test time</td> </tr> </table>	Status	<PASS>, <U_FAIL>, <L_FAIL>, <PROT>, or <ABOUT>	Settings, measured values	Test number, program number, test mode, measured voltage, measured current, test time
Status	<PASS>, <U_FAIL>, <L_FAIL>, <PROT>, or <ABOUT>				
Settings, measured values	Test number, program number, test mode, measured voltage, measured current, test time				

2 The input signals are all low-active control. The input terminal is pulled up to +12 V by a resistor. Leaving the input terminal open is equivalent to applying a high level signal.

## General

		TOS5200	
Display		LCD: LED backlight custom design	
Environment	Installation location		Indoors, at a height of up to 2000 m
	Spec guaranteed range	Temperature	5 °C to 35 °C (41 °F to 95 °F)
		Humidity	20 % rh to 80 % rh (no condensation)
	Operating range	Temperature	0 °C to 40 °C (32 °F to 104 °F)
		Humidity	20 % rh to 80 % rh (no condensation)
	Storage range	Temperature	-20 °C to 70 °C (-4 °F to 158 °F)
Humidity		90 % rh or less (no condensation)	
Power supply	Nominal voltage range (allowable voltage range)		100 Vac to 240 Vac (90 Vac to 250 Vac)
	Power consumption	When no load is connected (READY)	100 VA or less
		Rated load	800 VA max.
	Allowable frequency range		47 Hz to 63 Hz
Insulation resistance (between AC LINE and the chassis)		30 MΩ or more (500 Vdc)	
Withstanding voltage (between AC LINE and the chassis)		1500 Vac, 1 minute	
Earth continuity		25 Aac, 0.1 Ω or less	
Electromagnetic compatibility <sup>1 2</sup>		Complies with the requirements of the following directive and standards. EMC Directive 2014/30/EU EN 61326-1 (Class A <sup>3</sup> ) EN 55011 (Class A <sup>3</sup> , Group 1 <sup>4</sup> ) EN 61000-3-2 EN 61000-3-3 Applicable under the following conditions The maximum length of all cabling and wiring connected to the TOS5200 is less than 2.5 m. Shielded cables are being used when using the SIGNAL I/O. The high-voltage test lead TL31-TOS is being used. Electrical discharges are not occurring outside the DUT.	
Safety <sup>1</sup>		Complies with the requirements of the following directive and standard. Low Voltage Directive 2014/35/EU <sup>2</sup> EN 61010-1 (Class I <sup>5</sup> , Pollution degree 2 <sup>6</sup> )	
Dimensions		See "Outline drawing".	
Weight		Approx. 14 kg (30.9 lb.)	
Accessories	Power cord		1 pc.
	High-voltage test lead (TL31-TOS)		1 set (1 red wire and 1 black wire, each with alligator clips); 1.5 m
	SIGNAL I/O plug		1 set; assembly type
	High-voltage warning sticker		1 pc.
	Setup Guide		1 pc.
	Quick Reference		English: 1 pc. , Japanese: 1 pc.
	Safety Information		1 pc.
	CD-ROM		1 pc.

<sup>1</sup> Does not apply to specially ordered or modified TOS5200s.

<sup>2</sup> Limited to products that have the CE/UKCA mark on their panels. Not be in compliance with EMC limits unless the ferrite core is attached on the cable for connection of J1 connector.

<sup>3</sup> This is a Class A equipment. The TOS5200 is intended for use in an industrial environment. This product may cause interference if used in residential areas. Such use must be avoided unless the user takes special measures to reduce electromagnetic emissions to prevent interference to the reception of radio and television broadcasts.

<sup>4</sup> This is a Group 1 equipment. The TOS5200 does not generate and/or use intentionally radio-frequency energy, in the form of electromagnetic radiation, inductive and/or capacitive coupling, for the treatment of material or inspection/analysis purpose.

<sup>5</sup> This is a Class I equipment. Be sure to ground the TOS5200's protective conductor terminal. The safety of this product is only guaranteed when the product is properly grounded.

<sup>6</sup> Pollution is addition of foreign matter (solid, liquid or gaseous) that may produce a reduction of dielectric strength or surface resistivity. Pollution Degree 2 assumes that only non-conductive pollution will occur except for an occasional temporary conductivity caused by condensation.

## Outline drawing

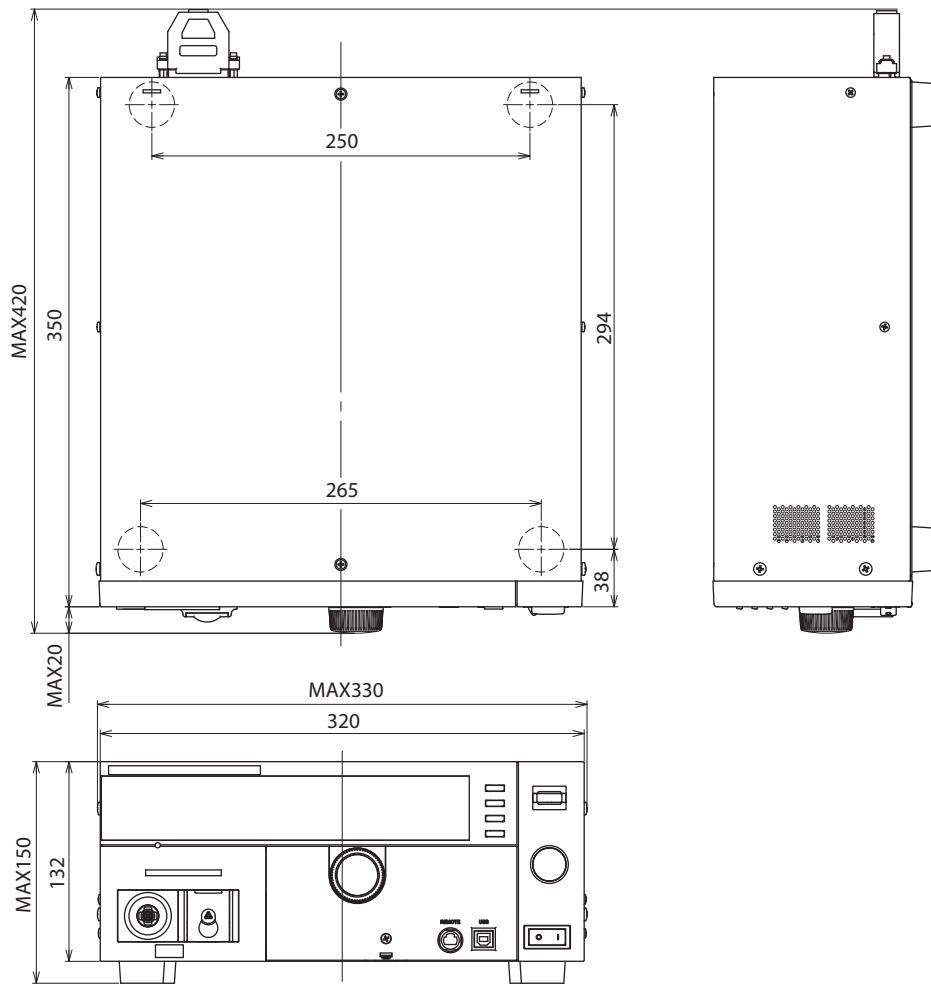

Unit: mm (inch)



# Appendix

---

- A List of Default Settings
- B Protection Functions
- C Test Start Operation and Display
- D Timing chart
- E Troubleshooting

# A List of Default Settings

## Initializing the TOS5200

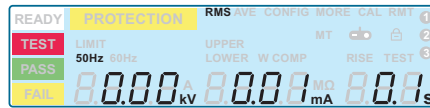

While holding down SHIFT, turn the POWER switch on.

When you initialize the TOS5200, all settings (such as test conditions) and saved data are reset to the default values shown below.

### Default values

Item			Setting after initialization
Withstanding voltage test conditions	Measurement mode		RMS
	Test voltage		0.00 kV
	Test voltage's limit voltage		5.50 kV
	Upper limit		0.02 mA
	Lower limit		OFF
	Test time		0.1 s
	Start voltage on and off		OFF
	Voltage rise time		0.1 s
	Voltage fall time		OFF
	Test voltage frequency		50 Hz
Interface setting			USB
CONFIG settings	Test Mode	Double Action	OFF
		Pass Hold	50 ms
		Momentary	OFF
		Fail Mode	OFF
	Buzzer Volume Level	Pass	3
		Fail	5
	Baudrate	9600	
	Talk Mode	OFF	
	Status Signal Output	H.V ON	OFF
		Test	OFF
		Pass	OFF
		Upper Fail	OFF
		Lower Fail	OFF
		Ready	OFF
Protection		OFF	
Power ON	OFF		



## Default panel memory values

There are three panel memory entries. Initially, these entries all contain AC withstanding voltage test conditions that comply with safety standards.

If you initialize the TOS5200, the panel memory entries are also returned to their default values.

Memory number	Setting	Setting after initialization
1 to 3	Test mode	ACW
	Output frequency	50 Hz
	Test voltage	0.00 kV
	Upper limit	0.02 mA
	Lower limit	OFF
	Test time	0.1 s
	Start voltage	OFF
	Voltage rise time	0.1 s
	Voltage fall time	OFF

# B Protection Functions

If one or more of the causes of the following problems occur, the protective circuits will activate, and you will no longer be able to use the TOS5200. This is referred to as PROTECTION mode.

When the TOS5200 switches to PROTECTION mode, "PROTECTION" on the screen lights. Follow the instructions below to remove the cause of the problem and clear the PROTECTION mode.

If the TOS5200 has switched to PROTECTION mode because of several causes, the cause with the highest priority is displayed. After you eliminate the cause, the cause with the next highest priority is displayed to indicate that there are more causes.

If you cannot clear the mode even by pressing STOP, turn the TOS5200 off and then back on.

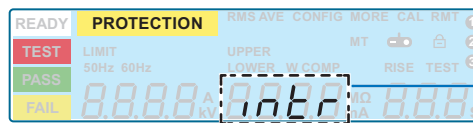

Display example when an interlock signal is detected

Panel display	Protection circuit	Description	Remedy
0000	Interlock Protection	An interlock signal was detected.	Remove the interlock signal input, and then press STOP.
PG00	Power Supply Protection	An error was detected in the power supply.	You can clear the PROTECTION mode by pressing STOP, but if the protection occurs frequently, repairs are necessary.
U000	Volt Error Protection	An output voltage outside of the rated limits was detected. Withstanding voltage test: $\pm 350$ V	Press STOP.
OL00	Over Load Protection	An output voltage causing the output power limit to be executed was detected. Withstanding voltage test: 550 VA	Press STOP.
OH00	Over Heat Protection	The internal temperature of the TOS5200 became too high.	Confirm that the internal temperature of the TOS5200 has decreased, and then press STOP.
OR00	Over Rating Protection	The output current was generated for a length of time that exceeds the regulated time.	Press STOP.
RE00	Remote Protection	A connection to or disconnection from the REMOTE connector was detected.	Check the REMOTE connector, and then press STOP.
SI00	SIGNAL I/O Protection	The SIGNAL I/O connector's ENABLE signal has changed.	Press STOP.
US00	USB Protection	During remote control operation, the USB connector was disconnected, or a defect was detected.	Check the USB connector, and then press STOP.

If you cannot clear the PROTECTION mode even after you have corrected all the causes, the TOS5200 may be malfunctioning.

Stop using the product, and contact your Kikusui agent or distributor..

# C

## Test Start Operation and Display

The following table shows the control sources that are enabled depending on the combination of remote control sources.

	Combination			Enabled remote control source	Indicator on the screen	
	Front panel REMOTE connector	Rear-panel SIGNAL I/O connector (the ENABLE signal is at low level)	USB or RS232C		"RMT"	
a	—	—	—	Panel	Off	Off
b	Yes	—	—	REMOTE connector	Off	On
c	—	Yes	—	SIGNAL I/O connector	Off	On
d	—	—	Yes	USB connector or RS232C connector	On	Off
e	Yes	Yes	—	SIGNAL I/O connector	Off	On

# D Timing chart

## PASS judgment

### ■ Setting conditions

Voltage rise time (RISE) : 100 ms  
 Test time (TEST) : 100 ms  
 Voltage fall time (Fall Time) : 0 ms  
 Frequency : 50 Hz  
 Start at SIGNAL I/O (Low-active control input).

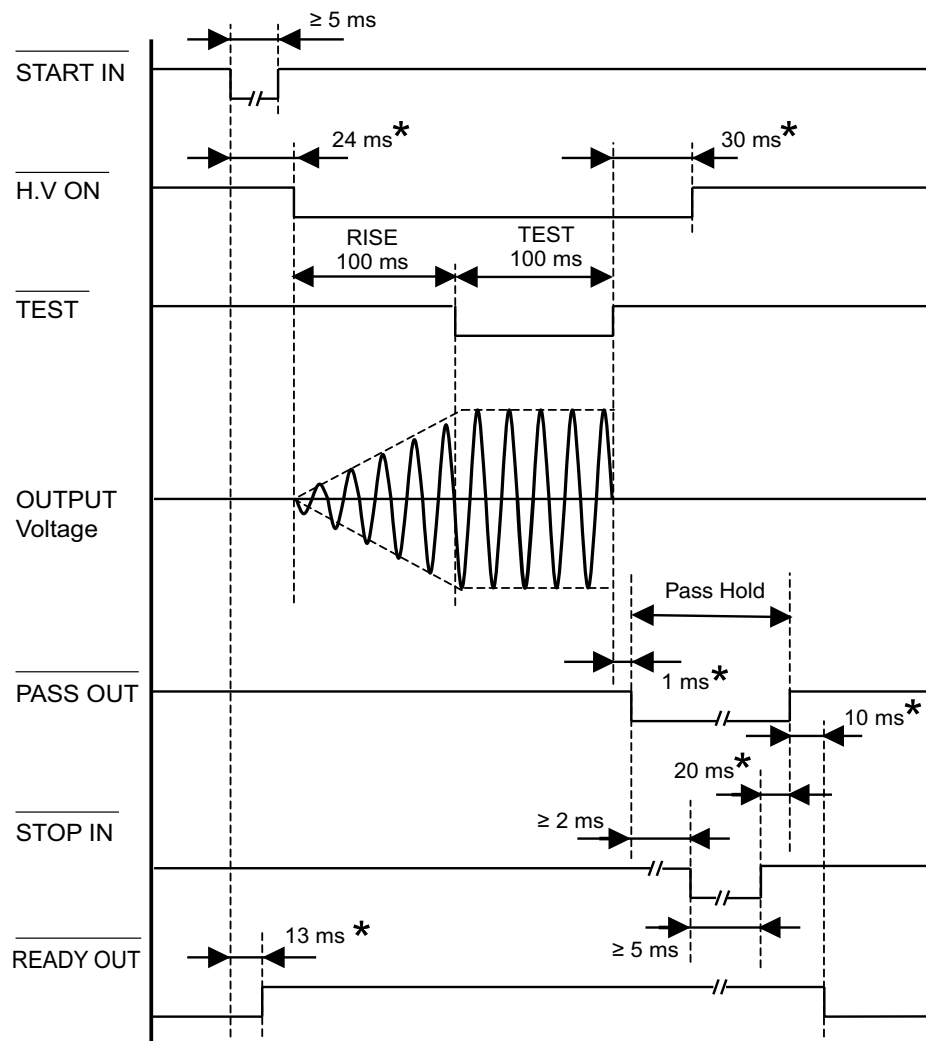

\* Typical value

# FAIL judgment

## ■ Setting conditions

- Voltage rise time (RISE) : 100 ms
- Test time (TEST) : OFF
- Voltage fall time (Fall Time) : 0 ms
- Frequency : 50 Hz

Start at SIGNAL I/O (Low-active control input).  
 FAIL judgment is UPPER FAIL.

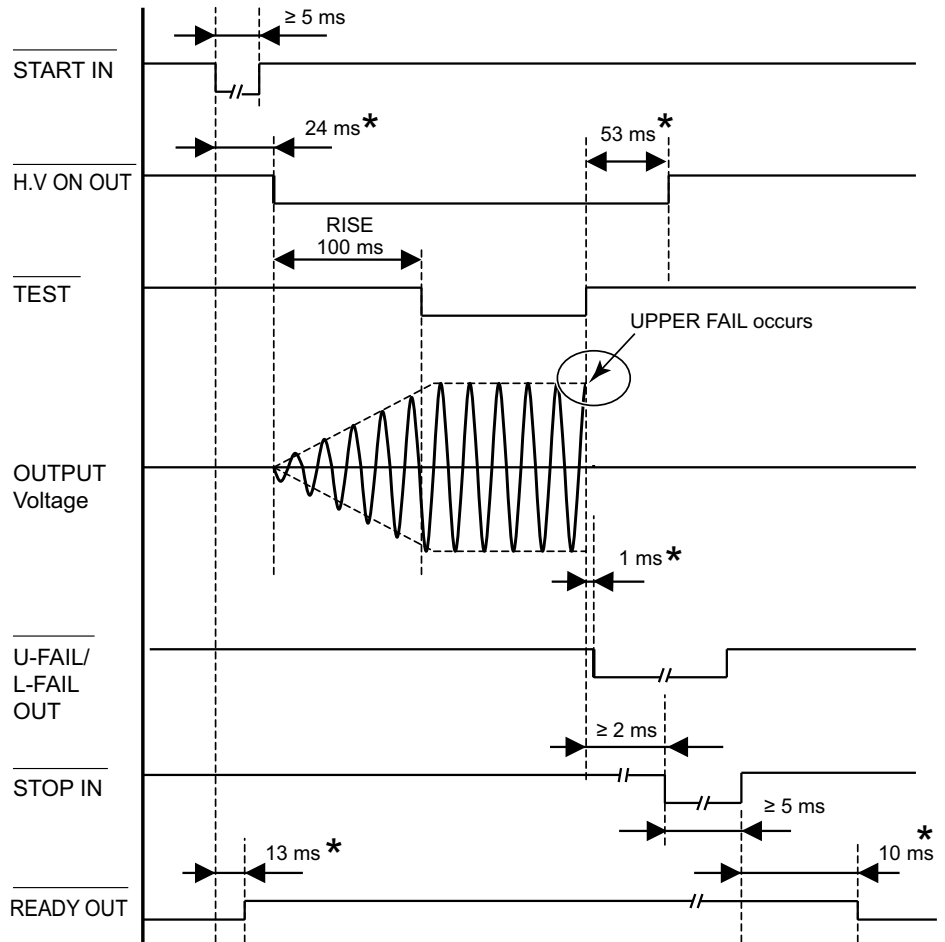

\* Typical value

## Takt Time

### ■ Setting conditions

Voltage rise time (RISE) : 100 ms  
Test time (TEST) : 100 ms  
Voltage fall time (Fall Time) : 0 ms  
Frequency : 50 Hz  
Start at SIGNAL I/O (Low-active control input).

#### NOTE

This is the minimum takt time for test currents less than equal to 50 mA. If the test current is greater than 50 mA, set an interval time that is at least twice as long as [RISE + TEST].

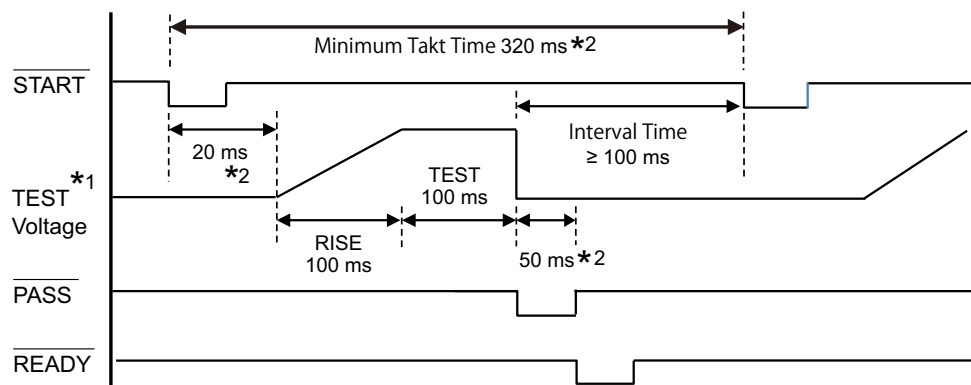

\*1. For simplicity, only the positive test voltage is indicated with an envelope curve.  
\*2. Reference value

# E Troubleshooting

This section introduces troubleshooting measures. Typical symptoms are listed. Check whether any of the items listed below apply to your case. In some cases, the problem can be solved quite easily.



 p. 72

If none of the items apply to your case, we recommend that you initialize the TOS5200 to its factory default settings. If the remedy does not correct the problem, contact your Kikusui agent or distributor.

## The power does not turn on

Symptom	Items to check and possible remedy	
The TOS5200 does not operate when the POWER switch is turned on.	Is the power cord disconnected?	p. 20
	Has the interlock feature been activated?	p. 22
	Release the interlock feature.	p. 59

## Unable to carry out panel operations

Symptom	Items to check and possible remedy	
Testing does not begin when the START switch is pressed.	Is a probe connected to the REMOTE connector? When a probe is connected, only the probe's START switch is enabled.	p. 26
	Is a STOP signal being applied to the SIGNAL I/O connector? When you are using the SIGNAL I/O connector to control the TOS5200, the START switch on the panel is disabled.	p. 57
	Is the TEST LED blinking? The TOS5200 is in the middle of the voltage rise time. The test will begin when the rise time elapses.	p. 48
	If a PROTECTION message is displayed on the screen? The TOS5200 is in PROTECTION mode. See "Protection Functions".	p. 74
	Is the double action feature on? Press STOP, and then press START within 0.5 seconds of pressing STOP. Alternatively, turn the double action feature off.	p. 45
	You cannot start tests while panel memory is being accessed.	p. 37
	Is a message displayed on the screen? A setting is invalid. Specify settings that are within the correct range.	p. 40
Panel operations are not being registered.	Is "KEY LOCK  displayed (or blinking) in the upper right of the screen? Release the key lock.	p. 36
	Is a "RMT" displayed on the screen? The product is being controlled remotely. To control the TOS5200 from the panel, press the LOCAL key to switch to local mode.	—
The TOS5200 does not switch to local mode even when I press the LOCAL key.	Was a local lockout (LLO) command sent through the communication interface? Use a communication command to clear LLO command.	—

## Unable to perform measurements

Symptom	Items to check and possible remedy	
The measured values are abnormal.	Are the test leads connected to the correct terminals? Connect the test leads properly.	p. 24

## PROTECTION mode cannot be cleared

Symptom	Items to check and possible remedy	See
PROTECTION mode cannot be cleared even if I press STOP and restart the TOS5200.	Is an interlock signal being applied? Stop the interlock signal input.	p. 59
	Is the internal temperature too high? Confirm that the internal temperature of the TOS5200 has decreased, and then clear the mode.	—
	Is the REMOTE connector connected properly? Check the REMOTE connector.	p. 11
	During remote control operation, did the USB or RS232C connector become disconnected or are there problems with the connector? Check the USB or RS232C connector.	p. 11 p. 12

## Unable to use remote control

Symptom	Items to check and possible remedy	See
Remote control is not possible through the RS232C interface.	Is the baudrate set correctly? Check the value.	p. 46



# Index

<b>A</b>	
accessories .....	2
<b>B</b>	
Buzzer Volume	
FAIL .....	46
PASS .....	45
<b>C</b>	
CONFIG setup screen .....	44
connection	
DUT .....	24
<b>D</b>	
default settings, list .....	72
Double Action .....	45
DUT .....	24
<b>F</b>	
Fail Mode .....	45
Fall Time .....	43
fall time control .....	43
firmware version .....	2
Frequency .....	43
<b>H</b>	
HP01A-TOS .....	26
HP02A-TOS .....	26
<b>I</b>	
initialization .....	72
inspection .....	62
judgment feature .....	62
test leads .....	62
Interlock Protection .....	74
<b>K</b>	
KEY LOCK .....	36
key lock .....	36
<b>L</b>	
L-FAIL .....	40
Lower Fail .....	47
lower limit judgment .....	32, 40
<b>M</b>	
measurement .....	43
measurement check .....	62
message	
invalid setting .....	40
Measurement .....	43
Momentary .....	45
<b>O</b>	
options .....	16
outline drawing .....	70
Over Heat Protection .....	74
Over Load Protection .....	74
Over Rating Protection .....	74
<b>P</b>	
panel memory .....	73
panel memory, saving .....	37
Pass .....	40, 47
Pass Hold .....	45
power cord .....	20
Power ON .....	47
Power Supply Protection .....	74
power, turning on .....	22
Protection .....	47
PROTECTION mode .....	74
protection mode .....	74
<b>R</b>	
rack mount adapter .....	16
Ready .....	47
Remote Protection .....	74
RISE .....	32
Rise Time .....	41
rise time control .....	32, 41
<b>S</b>	
SIGNAL I/O connector .....	54
SIGNAL I/O Protection .....	74
Start Voltage .....	43
<b>T</b>	
Talk Mode .....	36
TEST .....	47
test probe .....	17, 26
test, finish .....	51
test, starting .....	48
troubleshooting .....	79
<b>U</b>	
U-FAIL .....	40
Upper Fail .....	47
USB Protection .....	74

**V**

version .....2  
Volt Error Protection .....74

**W**

W COMP .....32, 40  
warm-up time .....64





If you find any misplaced or missing pages in the manuals, they will be replaced. If the manual gets lost or soiled, a new copy can be provided for a fee. In either case, please contact your Kikusui agent or distributor. At that time, inform your agent or distributor of the "Part No." written on the front cover of this manual.

Every effort has been made to ensure the accuracy of this manual. However, if you have any questions or find any errors or omissions, please contact your Kikusui agent or distributor.

After you have finished reading this manual, store it so that you can use it for reference at any time.

## **KIKUSUI ELECTRONICS CORP.**

---

1-1-3 Higashiyamata, Tsuzuki-ku, Yokohama,  
224-0023, Japan

Tel: +81-45-482-6353

Fax: +81-45-482-6261

[www.kikusui.co.jp/en](http://www.kikusui.co.jp/en)

