

OPERATION MANUAL

WITHSTANDING VOLTAGE TESTER
TOS5000 Series

TOS5050A TOS5051A

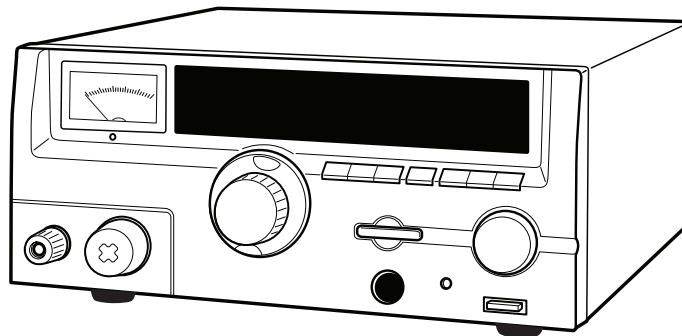

DANGER

This Tester generates high voltage.

- Any incorrect handling may cause death.
- Read “Handling Precautions” in this manual to prevent accident.
- Keep this manual near the tester for easy access of the operator.

Use of Operation Manual

Please read through and understand this Operation Manual before operating the product. After reading, always keep the manual nearby so that you may refer to it as needed. When moving the product to another location, be sure to bring the manual as well.

If you find any incorrectly arranged or missing pages in this manual, they will be replaced. If the manual gets lost or soiled, a new copy can be provided for a fee. In either case, please contact Kikusui distributor/agent, and provide the “Kikusui Part No.” given on the cover.

This manual has been prepared with the utmost care; however, if you have any questions, or note any errors or omissions, please contact Kikusui distributor/agent.

Disposing of used Kikusui products in the EU

Under a law adopted by member nations of the European Union (EU), used electric and electronic products carrying the symbol below must be disposed of separately from general household waste.

This includes the power cords and other accessories bundled with the products. When disposing of a product subject to these regulations, please follow the guidance of your local authority, or inquire with your Kikusui distributor/agent where you purchased the product.

The symbol applies only to EU member nations.



Disposal outside the EU

When disposing of an electric or electronic product in a country that is not an EU member, please contact your local authority and ask for the correct method of disposal.

Microsoft, and Visual Basic are registered trademarks of the Microsoft Corporation in the U.S. and other countries.

Reproduction and reprinting of this operation manual, whole or partially, without our permission is prohibited.

Both unit specifications and manual contents are subject to change without notice.

正誤表

TOS5050A/TOS5051A 取扱説明書

Part No. Z1-002-970, IB004798

本取扱説明書を以下のように変更いたします。
お手数ですが訂正してご使用ください。

ページ I

「本書が適用する製品の ROM バージョン」

変更前	・ TOS5050A : Ver.1.0X ・ TOS5051A : Ver.1.0X
変更後	・ TOS5050A : Ver.2.0X ・ TOS5051A : Ver.2.0X

Manual Changes

TOS5050A/TOS5051A Operation Manual

Part No. Z1-002-972, IB004839

Please make the following changes to the text in this manual.

Page I

“This manual is applicable to the Tester whose ROM version number is:”

Previous	・ TOS5050A: Ver.1.0X ・ TOS5051A: Ver.1.0X
New	・ TOS5050A: Ver.2.0X ・ TOS5051A: Ver.2.0X

Testing is not possible when you open the package.

If you turn on the power to the tester simply after taking the tester out from the box, testing is not possible because the interlock function is activated.

For a description of the interlock function, see section 6.3.3, “Interlock Function” in this manual. Then, operate the tester appropriately using the interlock function.

About this manual

This is the operation manual for the TOS5050A/TOS5051A Withstanding Voltage tester.

■ ROM version of the product to which this manual applies

- TOS5050A: Ver.1.0X
- TOS5051A: Ver.1.0X

To check the version number, refer to 5.2 “Checking the tester Operation.”

When you contact us for any information about the tester, please indicate the version number and the serial number of the tester. The serial number is written on the rear panel of the tester.

NOTE

• To those using the old model TOS5050/5051

The SIGNAL I/O connector on this tester is not compatible with that on the old model TOS5050/5051 (different pin assignments). Therefore, the 14-pin Amphenol plug that is supplied with the tester cannot be shared between the new and old models.

If you connect the Amphenol plug which you use for the old model to this tester, testing is not possible because the protection is not released.

To use the Amphenol plug for the old model to this tester, you have to change the wiring for the interlock function. For details, refer to section 6.3.2 Remote Control through the SIGNAL I/O Connector and 6.3.3 Interlock Function.

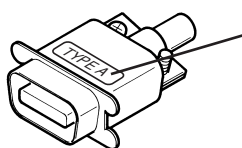

It is marked “TYPE A” to distinguish from the plug for the old model.

The 14-pin Amphenol plug that is supplied with this tester

To the supervisor in charge of operation

- If the operator does not read the language used in this manual, translate the manual into the appropriate language.
- Help the operator in understanding this manual before operation.
- Keep this manual near the tester for easy access by the operator.

For your own safety (to avoid electric shock)

While the tester is delivering its test voltage, never touch the following areas, or else, you will receive electric shock, and run the risk of death.

- the output terminal
- the test leads connected to the output terminal
- the Device Under Test (DUT)
- any area electrically connected to the output terminal.
- any area electrically connected to the output terminal immediately after the output has been cut off in the DC test mode.

Also, electric shock or accident may occur in the following cases:

- the tester being operated without grounding.
- if the gloves for electrical work are not used.
- approach any part connected to the output terminal while the power of the tester is turned on.
- approach any part connected to the output terminal immediately after the power of tester has been turned off in the DC test mode.

Power Requirements of this Product

Power requirements of this product have been changed and the relevant sections of the Operation Manual should be revised accordingly.

(Revision should be applied to items indicated by a check mark)

Input voltage

The input voltage of this product is _____ VAC,
and the voltage range is _____ to _____ VAC. Use the product within this range only.

Input fuse

The rating of this product's input fuse is _____ A, _____ VAC, and _____ .

-
-  **WARNING** • To avoid electrical shock, always disconnect the power cord or turn off the switch on the switchboard before attempting to check or replace the fuse.
- Use a fuse element having a shape, rating, and characteristics suitable for this product. The use of a fuse with a different rating or one that short circuits the fuse holder may result in fire, electric shock, or irreparable damage.
-

Safety Symbols

For the safe use and safe maintenance of this product, the following symbols are used throughout this manual and on the product. Understand the meanings of the symbols and observe the instructions they indicate (the choice of symbols used depends on the products).



Indicates that a high voltage (over 1000 V) is used here. Touching the part causes a possibly fatal electric shock. If physical contact is required by your work, start work only after you make sure that no voltage is output here.

DANGER

Indicates an imminently hazardous situation which, if ignored, will result in death or serious injury.



Indicates a potentially hazardous situation which, if ignored, could result in death or serious injury.



Indicates a potentially hazardous situation which, if ignored, may result in damage to the product and other property.



Shows that the act indicated is prohibited.



Is placed before the sign “DANGER,” “WARNING,” or “CAUTION” to emphasize these. When this symbol is marked on the product, see the relevant sections in this manual.



Indicates a protective conductor terminal.



Indicates a chassis (frame) terminal.



Safety Precautions

The following safety precautions must be observed to avoid fire hazard, electrical shock, accidents, and other failures. Keep them in mind and make sure that all of them are observed properly.



Users

- This product must be used only by qualified personnel who understand the contents of this operation manual.
- If it is handled by disqualified personnel, personal injury may result. Be sure to handle it under supervision of qualified personnel (those who have electrical knowledge.)
- This product is not designed or manufactured for general home or consumer use.

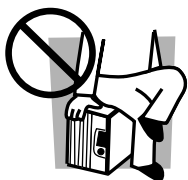

Purposes of use

- Do not use the product for purposes other than those described in the operation manual.

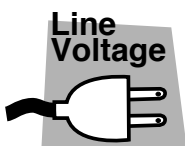

Input power

- Use the product with the specified input power voltage.
- For applying power, use the power cord provided. Note that the provided power cord is not use with some products that can switch among different input power voltages or use 100 V and 200 V without switching between them. In such a case, use an appropriate power cord.



Fuse

- With products with a fuse holder on the exterior surface, the fuse can be replaced with a new one. When replacing a fuse, use the one which has appropriate shape, ratings, and specifications.

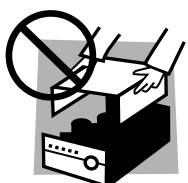

Cover

- There are parts inside the product which may cause physical hazards. Do not remove the external cover.

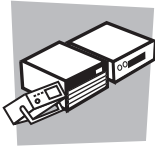

Installation

- When installing products be sure to observe “2.2 Precautions Concerning Installation Location” described in this manual.
- To avoid electrical shock, connect the protective ground terminal to electrical ground (safety ground).
- When connecting the power cord to a switchboard, be sure work is performed by a qualified and licensed electrician or is conducted under the direction of such a person.
- When installing products with casters, be sure to lock the casters.



Relocation

- Turn off the power switch and then disconnect all cables when relocating the product.
- Use two or more persons when relocating the product which weights more than 20 kg. The weight of the products can be found on the rear panel of the product and/or in this operation manual.
- Use extra precautions such as using more people when relocating into or out of present locations including inclines or steps. Also handle carefully when relocating tall products as they can fall over easily.
- Be sure the operation manual be included when the product is relocated.



Operation

- Check that the AC input voltage setting and the fuse rating are satisfied and that there is no abnormality on the surface of the power cord. Be sure to unplug the power cord or stop applying power before checking.
- If any abnormality or failure is detected in the products, stop using it immediately. Unplug the power cord or disconnect the power cord from the switchboard. Be careful not to allow the product to be used before it is completely repaired.
- For output wiring or load cables, use connection cables with larger current capacity.
- Do not disassemble or modify the product. If it must be modified, contact Kikusui distributor/agent.



Maintenance and checking

- To avoid electrical shock, be absolutely sure to unplug the power cord or stop applying power before performing maintenance or checking.
- Do not remove the cover when performing maintenance or checking.
- To maintain performance and safe operation of the product, it is recommended that periodic maintenance, checking, cleaning, and calibration be performed.



Service

- Internal service is to be done by Kikusui service engineers. If the product must be adjusted or repaired, contact Kikusui distributor/agent.

Front Panel and Rear Panel

- When accessing the panels, be sure to read chapter 3, "Handling Precautions."

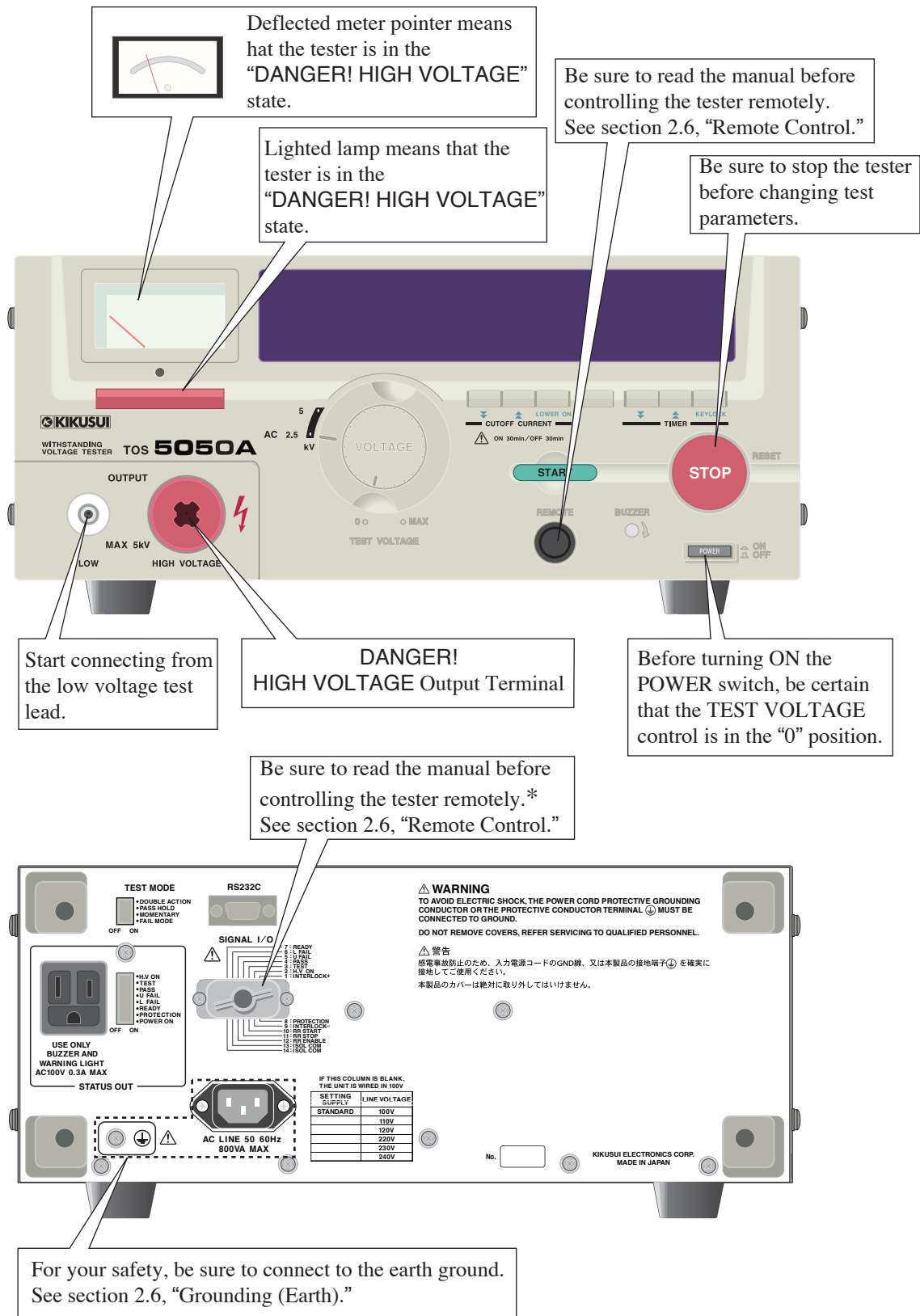

* The SIGNAL I/O connector on this tester is not compatible with that on the old model TOS5050/5051 (different pin assignments). For details, refer to section 6.3.2 Remote Control through the SIGNAL I/O Connector and 6.3.3 Interlock Function.

Contents

Power Requirements of this Product _____	III
Safety Symbols _____	IV
Safety Precautions _____	V
Chapter 1 General _____	1-1
1.1 Overview -----	1-2
1.2 Features -----	1-2
1.3 Options -----	1-5
Chapter 2 Installation and Preparation _____	2-1
2.1 Checking the Package Contents -----	2-2
2.2 Precautions Concerning Installation Location -----	2-3
2.3 Precautions When Moving the tester -----	2-4
2.4 AC Line Requirements -----	2-4
2.5 Connecting the Power Cord -----	2-5
2.6 Grounding (Earth) -----	2-6
Chapter 3 Handling Precautions _____	3-1
3.1 Preparative Procedures -----	3-2
3.1.1 Wearing Insulation Gloves -----	3-2
3.1.2 Grounding the Tester -----	3-2
3.2 Warnings and Cautions When Operating the Tester -----	3-2
3.2.1 Before Turning ON the AC Input Power -----	3-2
3.2.2 Connecting the Low Test Lead -----	3-2
3.2.3 Connecting the High Test Lead -----	3-3
3.2.4 Before Changing Test Parameters -----	3-3
3.2.5 Precautions for Pausing Tests -----	3-4
3.2.6 Items Charged Up to Dangerous High Voltages -----	3-4
3.3 Warnings after Turning OFF the Power -----	3-5
3.3.1 Check Items after Turning OFF the Power -----	3-5
3.3.2 Residual High Voltages (TOS5051A Only) -----	3-5
3.4 Warnings for Remote Control -----	3-6
3.5 Inhibitions -----	3-6
3.5.1 Inhibition of Rapid ON/OFF Repetitions -----	3-6
3.5.2 Inhibition of Shorting to Earth Ground -----	3-6
3.6 Actions to Be Taken in Emergency -----	3-7
3.7 Breakdown -----	3-7
3.7.1 Stopping the Use of Broken Testers -----	3-7
3.7.2 DANGER Lamp -----	3-7
3.8 Wattage, Heat, and Other Limiting Conditions of Use -----	3-8
Chapter 4 Description of Front and Rear Panel Items _____	4-1
4.1 Description of Front Panel Items -----	4-2

4.2	Display Items	4-13
4.3	Description of Rear Panel Items	4-19
Chapter 5 Preparative Test Procedures		5-1
5.1	Initial Setup	5-2
5.2	Checking the Tester Operation	5-4
5.3	Checking the Tester before Starting Test Operation	5-6
Chapter 6 Test Procedures		6-1
6.1	AC Withstanding Voltage Test Procedure	6-2
6.1.1	Selecting an AC Test Voltage Range	6-2
6.1.2	Setting the Upper Cutoff Current	6-2
6.1.3	Setting the Lower Cutoff Current	6-3
6.1.4	Setting the Test Time	6-5
6.1.5	Setting the Test Voltage	6-6
6.1.6	Connecting the DUT	6-6
6.1.7	Executing a Test	6-7
6.2	DC Withstanding Voltage Test Procedure (TOS5051A Only)	6-11
6.2.1	Selecting a DC Test Voltage Range	6-11
6.2.2	Setting the Upper Cutoff Current	6-12
6.2.3	Setting the Lower Cutoff Current	6-13
6.2.4	Setting the Test Time	6-14
6.2.5	Setting the Test Voltage	6-15
6.2.6	Connecting the DUT	6-15
6.2.7	Executing a Test	6-16
6.3	Remote Control	6-20
6.3.1	Remote Control through the REMOTE Connector	6-20
6.3.2	Remote Control through the SIGNAL I/O Connector	6-21
6.3.3	Interlock Function	6-24
6.3.4	Start/Stop Control	6-25
6.3.5	Output Signal	6-27
6.4	STATUS OUT	6-28
6.5	Settings for Special Test Modes	6-29
6.5.1	DOUBLE ACTION Switch	6-29
6.5.2	PASS HOLD Switch	6-29
6.5.3	MOMENTARY Switch	6-30
6.5.4	FAIL MODE Switch	6-30
Chapter 7 RS-232C Interface		7-1
7.1	Connecting the Cable	7-2
7.2	RS-232C Specifications	7-2
7.3	Communication Method	7-3
7.4	Talk Mode	7-3
7.5	Before Using the RS-232C	7-5

7.6	RS-232C Commands and Responses	7-7
7.7	Sample Program	7-10
Chapter 8 Operating Principle		8-1
8.1	Block Diagrams	8-2
8.2	Zero-turn-on Switch	8-4
8.3	Delay Time for Pass/Fail Judgment in DC Mode	8-5
8.4	Automatic Discharge Function	8-5
Chapter 9 Maintenance		9-1
9.1	Cleaning	9-2
9.2	Checking the Cord and Leads	9-2
9.3	Maintenance	9-3
9.4	Calibration	9-3
Chapter 10 Specifications		10-1
10.1	Basic Performance	10-2
10.2	Interface and Other Functions	10-5
10.3	General Specifications	10-7
10.4	Outline Drawing	10-8
Index		I- 1



Chapter 1 General

This chapter gives an overview and introduces the features of the tester.

1.1 Overview

The TOS5051A/5050A is a tester for carrying out withstanding voltage tests on electronic devices and electronic parts. The TOS5051A is capable of carrying out both AC tests and DC tests; the TOS5050A is capable of carrying out AC tests.

This tester integrates new ideas and technologies with the conventional, consistent philosophy of providing the highest safety, reliability, and operability to the operator.



- **WARNING** The tester is equipped with various safety features to protect the operator from hazards. However, when the tester is in use, high voltage is applied to the DUT. Inadvertently touching the DUT, test leads, probes, and output terminals can cause electric shock.
 - Be sure to provide full protective measures around the tester and DUT to prevent electric shock--such as to enclose the test area with rope fences to prevent access.
-

1.2 Features

1. Tests complying with major industrial standards

The tester can carry out withstanding (dielectric strength) tests on electronic devices and electronic parts in compliance with JIS, UL, CSA, BS, and other major electrical standards and ordinances.

2. Transformer capacity of 500 VA

The tester is equipped with a transformer, rated 500 VA.

3. Rational layouts of keys and switches

The keys have a slant-plane for easy viewing and convenient operation. The switch for AC/DC select and test voltage range select and the control for test voltage adjustment are installed concentrically, allowing you to operate them conveniently with two concentric knobs. For the adjustment of the pass/fail-judgment limit current and timer, dedicated increment/decrement keys are provided. These keys and switches, together with the large display easy to view, are laid out rationally and will assist you to conduct your tests accurately and efficiently.

4. A large color display

The tester has a large color vacuum fluorescent display. The wide viewing angle and high intensity indicates information in clearly. Various information including test conditions, instrument status, measured values, and result of pass/fail judgment are indicated using large letters and color assisting you to conduct your tests accurately and efficiently.

5. An analog voltmeter and a digital voltmeter

The tester is equipped with an analog voltmeter ($\pm 5\%$ FS) and a digital voltmeter ($\pm 1.5\%$ FS)--the former for quick grasp of the voltage and the latter for more accurate readout--assisting you to conduct your tests rapidly but accurately.

6. A digital ammeter

The digital ammeter can be used to measure the current that flows through the DUT (device under test).

7. A window comparator for pass/fail judgment

The tester has a window comparator for pass/fail judgment with reference to both upper (U) and lower (L) criteria (cutoff current). The comparator generates a FAIL signal when the measured current that flows through the DUT is greater than the preset upper limit criterion or when it is less than the preset lower limit criterion. The L FAIL detection function contributes to improve the test reliability by detecting open-circuits and bad contacts of the test leads. The tester has a separate indicator and signal output for each type of failure (U type and L type). This allows you to immediately find out whether the failure is a withstand voltage failure or an open-circuit/bad-contact failure.

You can preset the upper limit and lower limit currents (cutoff currents) independently, within the ranges shown in the following table.

Model	Preset range of upper and lower limits	
TOS5051A	0.1 mA to 110 mAAC	200 steps
	0.1 mA to 11 mADC	101 steps
TOS5050A	0.1 mA to 110 mAAC	200 steps

8. A digital timer

The timer allows you to preset the period during which the test voltage is to be applied to the DUT. The preset range is 0.5 to 999 seconds (in 1895 steps). When the timer function is ON, the preset period is decreased and the timer indicates the remaining period; when it is OFF, time is increased and the timer indicates the elapsed period.

9. Remote control function

The tester has functions for remote start/stop control operation. That is, it has a 5-pin DIN connector (for the optional remote control box or high voltage test probe) on its front panel and a 14-pin Amphenol connector on its rear panel. The remote control function, together with the status signal function, will help you conduct efficient automatic labor-saving tests.

10. Status signals

The tester delivers seven status signals--namely, H.V ON, TEST, PASS, U FAIL, L FAIL, READY, and PROTECTION--through its 14-pin Amphenol connector (shared with the remote control signals) on the rear panel. The signal form is open collector. The tester can deliver a 100 VAC output in response to one of eight states--namely, H.V ON, TEST, PASS, U FAIL, L FAIL, READY, PROTECTION, and POWER ON. Used in conjunction with the remote control function, these status signals will help you to conduct still more efficient automatic labor-saving tests.

11. Compact and light

The tester is compact and light as shown below.

Model	Overall dimensions	Weight
TOS5051A	320 mm (W) × 132 mm (H) × 300 mm (D)	16 kg
TOS5050A		15 kg

12. Memory backup function

When you turn the tester OFF, the tester stores its existing test state in its non-volatile memory. When you turn the tester ON the next time, the tester recalls the stored information and restores the test state that existed when you turned OFF the power last time.

13.A safer high voltage output terminal

The lead insertion portion of the high voltage output terminal is structured with a restriction for safer connection.

14.A DANGER lamp

The tester has a large and bright DANGER lamp. This lamp lights when electric charge is remaining on the output terminal, warning you of a possible electric shock hazard.

15. Interlock function

The tester has an interlock function that shuts down the output voltage in synchronization with the external device. When this function is activated, the output is shut down and keeps tests from being executed.

The interlock function operates even if there is open-circuit or bad contact in the signal line, thereby enhancing further the operation safety.

16. Keylock function

The tester has a keylock function to disable all keys (except the START/STOP keys) to guard against inadvertent key operation by the operator or an unauthorized person. This improves the reliability of tests.

17. Switches for safer operation

A rotary switch is used for AC/DC test mode selection and test voltage range selection. The START switch is of a recessed type. These features, together with the keylock function, enhance operation reliability and safety.

18.Noise-resistant circuits

The internal circuits of the tester are designed to be highly resistant against noise, thereby enhancing the operation reliability.

19.Automatic discharge function (TOS5051A only)

When the DC test output voltage is turned off, the output circuit is automatically discharged, thereby discharging the charge in the device under test (DUT). This feature, together with the DANGER lamp, enhances the test operation safety.

20.A DC/DC converter for quality DC test voltage (TOS5051A only)

The tester has a DC/DC converter which generates a quality test voltage of high stability with less ripple.

21.Equipped with a RS-232C interface for outputting test data and test results

The measurement results can be output to a PC or printer.

1.3 Options

Model RC01-TOS/RC02-TOS remote control box

Model RC01-TOS or RC02-TOS remote control box is used to remotely control the start/stop of test operation of the tester. Connect the Control Box to the REMOTE connector on the front panel of the tester. The RC01-TOS has one START switch; RC02-TOS has two START switches. The test starts when you press both switches at the same time, thereby enhancing the operating safety.

Description of the RC01-TOS/RC02-TOS function	
OPERATE switch	This switch enables (when ON) or disables (when OFF) the START switch or switches.
START switch	The test starts when you press this switch (or switches) if the OPERATE switch is ON and the tester is in the READY status.
STOP switch	This switch terminates the test (cuts off the test voltage or resets the tester from the FAIL or other particular status--its functions are the same with those of the STOP switch on the front panel of the tester.

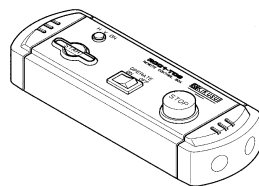

RC01-TOS
200(W) × 70(H) × 39(D) mm

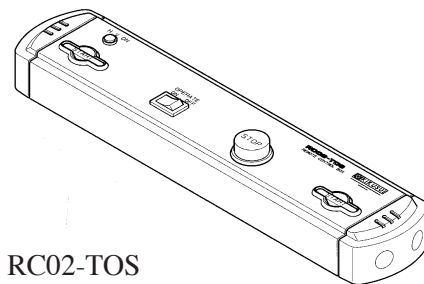

RC02-TOS
330(W) × 70(H) × 39(D) mm

Model HP01A-TOS/HP02A-TOS high voltage test probe

The high voltage test probe renders a three-fold operating safety. The test voltage is not delivered unless you squeeze with one hand the slide lever of the grip of the probe and pull the trigger while you press with the other hand the switch on top of the probe. If you release your hand, the probe immediately delivers a STOP signal to cut off the test voltage.

Model	Voltage rating	Cable length
HP01A-TOS	4 kVAC (rms), 50/60 Hz	Approx. 1.8 m
HP02A-TOS	5 kVDC	Approx. 3.5 m

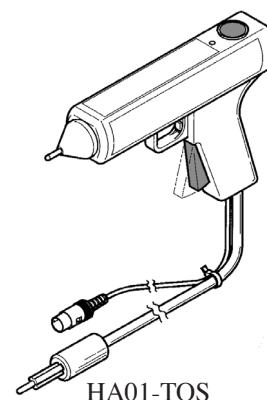

⚠ WARNING

- The maximum voltage rating of the probe is 4 kVACrms or 5 kVDC. Never apply voltages exceeding the voltage rating.
- Do not connect the probe to or disconnect it from the DUT while the test voltage is being delivered. If you do, the DUT may be damaged. If you disconnect the probe from the DUT while the test voltage is being delivered, the DUT will remain charged at the high test voltage. Before connecting the probe to the DUT, be sure that the test voltage is OFF (the LED on top of the probe is OFF); before disconnecting the probe from the DUT, be sure that the test voltage is OFF (the LED is OFF).

NOTE

- If you need to perform a test in compliance to the UL Standard by using the probe, turn the FAIL MODE switch (DIP switch on the rear panel) of the tester to ON. If this switch is ON, the tester behaves in the following manner and you can accurately confirm the FAIL status. When a test is terminated due to a failure, the FAIL status on the tester is not reset even when you release the probe. To reset the FAIL status, you must press the STOP switch on the tester. For details, refer to Section 6.5.4, “FAIL MODE Switch” (page 6-30).

Model PL01-TOS warning light unit

This unit indicates that the tester is in the TEST-ON status (delivering the test voltage).

Model BZ01-TOS buzzer unit

This unit may be used when the sound generated by the buzzer housed in the tester is insufficient. This unit can be driven by the FAIL status signal of the tester.

High Voltage test leads

Model	Voltage rating	Cable length	Remarks
TL01-TOS	5 kVAC (rms), 50/60 Hz	Approx. 1.5 m	Tester accessory
TL02-TOS	5 kVDC	Approx. 3.0 m	

2

Chapter 2 Installation and Preparation

This chapter describes the procedures from unpacking to preparation before use.

2.1 Checking the Package Contents

When you receive the product, check that all accessories are included and that the product and accessories have not been damaged during transportation.

If any of the accessories are damaged or missing, contact Kikusui distributor/agent.

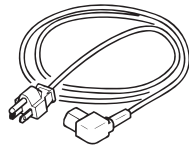

or

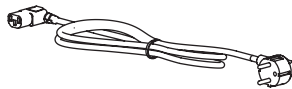

or

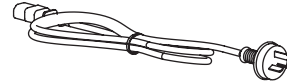

Rated voltage: 125 Vac
PLUG: NEMA5-15
[85-AA-0003]

Rated voltage: 250 Vac
PLUG: CEE7/7
[85-AA-0005]

Rated voltage: 250 Vac
PLUG: GB1002
[85-10-0790]

- Power cord 1
(1 piece)

The power cord that is provided varies depending on the destination for the product at the factory-shipment.

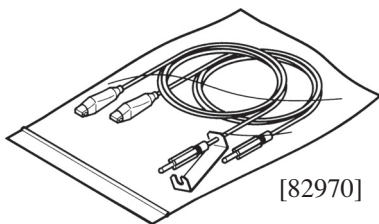

[82970]

- High voltage test leads
TL01-TOS (1.5 meters) (1 set)

The plug that is supplied cannot be shared between the new and old models.

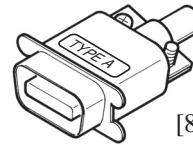

[83-21-4000]

- 14-pin Amphenol connector plug* (1 piece)
Assembly type

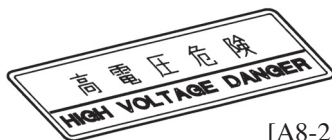

[A8-210-202]

- "HIGH VOLTAGE DANGER" sticker (1 sheet)

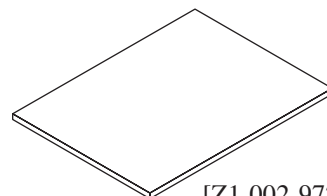

[Z1-002-972]

- Operation manual (1 copy)

Fig.2-1 Accessories

NOTE

- It is recommended that all packing materials be saved, in case the product needs to be transported at a later date.
- Attach the "HIGH VOLTAGE DANGER" sticker to a conspicuous place on the tester or near the installation location.
- * **To those using the old model TOS5050/5051**

The SIGNAL I/O connector on this tester is not compatible with that on the old model TOS5050/5051 (different pin assignments). Therefore, the 14-pin Amphenol plug that is supplied with the tester cannot be shared between the new and old models. It is marked "TYPE A" to distinguish the two.

2.2 Precautions Concerning Installation Location

This section describes the precautions to be taken when installing the product. Make sure to observe them.

■ Do not use the tester in a flammable atmosphere.

To prevent the possibility of explosion or fire, do not use the product near alcohol, thinner or other combustible materials, or in an atmosphere containing such vapors.

■ Avoid locations where the tester is exposed to high temperature or direct sunlight.

Do not place the product near a heater or in areas subject to drastic temperature changes.

Operating temperature range: 0 °C to +40 °C (+32 °F to +104 °F)

Storage temperature range: -20 °C to +70 °C (-4 °F to +158 °F)

■ Avoid humid environments.

Do not place the product in high-humidity locations--near a boiler, humidifier, or water supply.

Operating humidity range: 20 % to 80 % RH (no condensation)

Storage humidity range: 0 to 80 % RH (no condensation)

Condensation may occur even within the operating humidity range. In such case, do not use the product until the condensation dries up completely.

■ Do not place the tester in a corrosive atmosphere.

Do not install the tester in a corrosive atmosphere or in environments containing sulfuric acid mist, etc. This may cause corrosion of various conductors and bad contacts of connectors inside the tester leading to malfunction and failure, or in the worst case, a fire.

■ Do not place the tester in a dusty location.

Accumulation of dust can lead to electric shock or fire.

■ Do not use the tester where ventilation is poor.

Secure adequate space around the product so that air can circulate around it.

■ Do not place objects on top of the tester.

Placing objects on top of the tester can cause failures (especially heavy objects).

■ Do not place the tester on an inclined surface or location subject to vibrations.

The tester may fall or tip over causing damages and injuries.

■ Do not use the tester in a location where strong magnetic or electric fields are nearby or a location where large amount of distortion and noise is present on the input power supply waveform.

The product may malfunction.

■ **Do not use the tester near highly sensitive measuring instruments or transceivers.**

Do not operate the tester near highly sensitive measuring instruments such as communication receivers, because the noise generated by the tester may interfere with such devices.

Above 3 kV test voltage, the tester may produce corona discharge between its test lead clips which will generate a significant amount of broadband RF emission. To minimize this effect, separate the alligator clips and leads away from each other and from conducting surfaces, especially sharp metal edges.

■ **Secure adequate space around the power plug.**

Do not insert the power plug to an outlet where accessibility to the plug is poor. And, do not place objects near the outlet that would result in poor accessibility to the plug.

2.3 Precautions When Moving the tester

When moving the tester to the installation location or when transporting the tester, note the following points.

■ **Turn OFF the POWER switch.**

Moving the tester with the power ON may result in electric shock or damage.

■ **Remove all wiring.**

Moving the tester with the cables connected can cause wires to break or injuries due to the tester falling over.

■ **When transporting the tester, be sure to use the original packing materials.**

Otherwise, damage may result from vibrations or from the tester falling during transportation.

2.4 AC Line Requirements

The AC line requirements of the tester are as follows:

Nominal voltage	Voltage tolerance	Nominal frequency
100 V	±10 % of nominal voltage	50/60 Hz

The standard nominal AC line voltage of the tester is 100 V. The tester normally operates on an AC line voltage within ±10 % of the nominal voltage. If the line voltage is outside of this range, the tester may not operate normally or may be damaged. If your AC line voltage is outside of this range, be sure to convert it into within this range by using an autotransformer or other appropriate means.

Testers that operate on other AC line voltages as shown below also are available as factory-modification options.

Optional AC line voltages	110 V	120 V	220 V	230 V	240 V
---------------------------	-------	-------	-------	-------	-------

The following table is printed on the rear panel of the tester. If nothing is marked in the “SETTING SUPPLY” column, the nominal voltage is 100 V. The change in the nominal voltage is made at the factory. If a change has been made, a mark is indicated to the left of the corresponding voltage.

Before turning ON the AC input power of the tester, be sure that your AC line voltage conforms with the nominal voltage indicated on the indicator sheet.

SETTING SUPPLY	LINE VOLTAGE
STANDARD	100 V
	110 V
	120 V
	220 V
	230 V
	240 V

-
- ⚠ WARNING** • Do not modify your tester by yourself. Consult Kikusui distributor/agent to have your tester modified.
-

2.5 Connecting the Power Cord

-
- ⚠ WARNING** • This product is designed to be connected to a power supply classified as overvoltage category II. Do not connect to a power supply classified as overvoltage category III or IV.
-

- *Do not use the power cord that comes with the product as a power cord for other equipment.*
1. Check that the AC power supply is within the input power supply range of the product.
 2. Check that the POWER switch is turned OFF.
 3. Connect the power cord to the AC LINE connector on the rear panel.
 4. Insert the power plug to the outlet.

-
- NOTE** • The tester should be connected to a stable AC power supply. From the tester’s internal circuit configuration of view in the AC withstanding voltage test, the output voltage is affected by fluctuations of the AC power supply.
-

2.6 Grounding (Earth)

- ⚠ WARNING**
- Electric shock may occur, if proper grounding is not furnished.
 - This product is designed as a Class I equipment (equipment furnished with electric shock protection through protective grounding in addition to the basic insulation). Be sure to connect the protective ground terminal to an appropriate earth ground.

- ⚠ CAUTION**
- If you do not ground the product, malfunction may occur due to external noise, or the noise generated by the product may become large.

Make sure to ground the unit for your safety.

There are two types of methods in grounding the tester. Make sure to ground the tester using either method.

1. Connect the power cord to a three-pin power outlet with proper grounding.

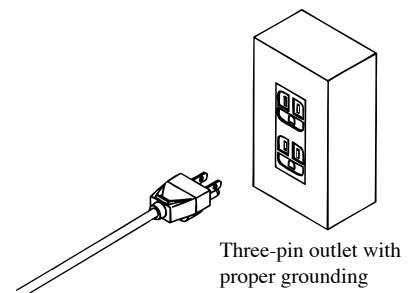

2. Connect the grounding (earth) terminal on the rear panel to the earth ground.

A qualified personal shall select and create the wiring and make the attachments.

Securely connect the wiring using appropriate tools.

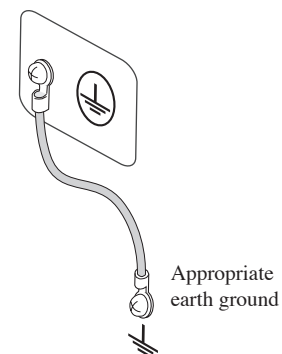

Fig. 2-2 Grounding method

3

Chapter 3 Handling Precautions

This chapter gives warnings and cautions you must observe when operating the tester.

-
- ⚠ WARNING** • The tester delivers a 5 kV test voltage which can cause electric shock. When operating the tester, be extremely careful and observe the cautions, warnings, and other instructions given in this chapter.
-

3.1 Preparative Procedures

3.1.1 Wearing Insulation Gloves

When handling the tester, be sure to wear insulation gloves in order to protect yourself against high voltages. If you cannot obtain insulation gloves, please contact Kikusui distributor/agent for them.

3.1.2 Grounding the Tester

Be sure to ground the tester. To do this, connect securely (using a tool) an earth line to the protective grounding terminal on the rear panel of the tester. Unless the tester is securely grounded, when the tester output is shorted to an earth line or to a conveyor or other device which is connected to an earth line or when it is shorted to the AC line*¹, the tester chassis can be charged up to the high voltage that can cause electric shock.

For a description of the grounding method, see section 2.6, “Grounding (Earth)” (Page 2-6).

DESCRIPTION *1 The term “AC line” here means the line on which the tester is operating. That is the line to whose outlet the power cord of the tester is connected. It may be of a commercial AC power line or of a private-generator AC power line.

3.2 Warnings and Cautions When Operating the Tester

3.2.1 Before Turning ON the AC Input Power

Before turning on the AC input power, be certain that the TEST VOLTAGE control knob is at the “0” position (fully counterclockwise position).

3.2.2 Connecting the Low Test Lead

For the connection method of the low test lead to the LOW output terminal of the tester, see Fig. 3-1. Each time before using the tester, check that the low test lead is not broken.

When connecting the tester to a DUT (device under test), connect the low test lead first (and the high test lead next) and be sure that it securely connects the LOW output terminal of the tester to the corresponding terminal (chassis protective grounding terminal) of the DUT. If the connection is inadequate, entire DUT can be charged up to a hazardous high voltage.

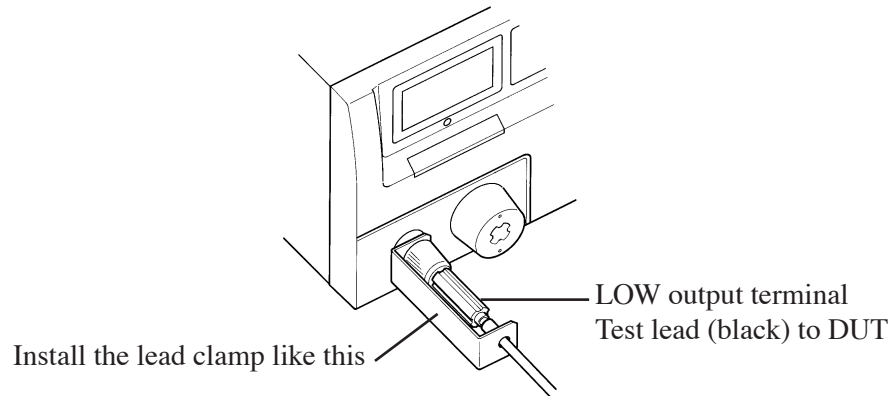

Fig.3-1 Connecting the low-voltage test lead

3.2.3 Connecting the High Test Lead

Be sure to observe the order of lead connections--the low test lead first and the high test lead next. To connect the tester to a DUT, proceed as follows:

1. Press the STOP switch.
2. Check that the output voltmeter reading is "0".
3. Check that the DANGER lamp is OFF.
4. Connect the high test lead to the HIGH VOLTAGE output terminal.
5. Short the low and high test leads, and check that high voltage is not present.
6. Connect the tester to the DUT, with the low output lead first and high output lead next.

3.2.4 Before Changing Test Parameters

Before changing test parameters, press the STOP switch and be certain that the TEST VOLTAGE control knob is at the "0" position (fully counterclockwise).

3.2.5 Precautions for Pausing Tests

When you pause a test, be sure to turn the TEST VOLTAGE control knob to the “0” position (fully counterclockwise) and press the STOP switch. If you are not going to resume the test soon or if you are leaving the test area, be sure to turn OFF the switch.

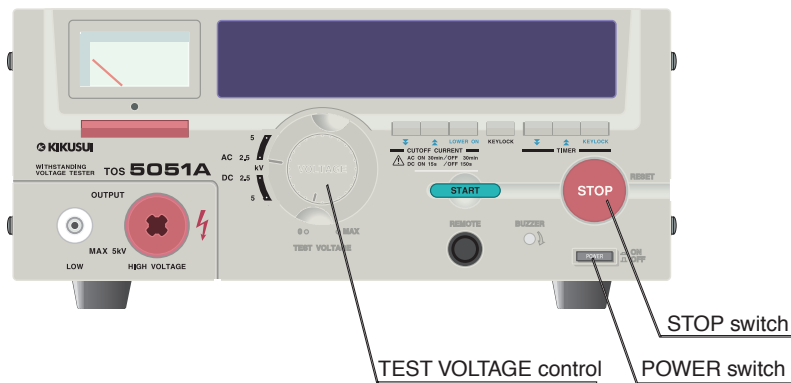
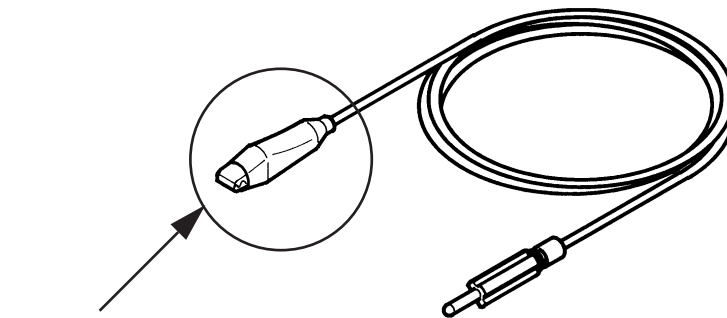

Fig. 3-2 TOS5051A front panel

3.2.6 Items Charged Up to Dangerous High Voltages

While the test is in progress (“TEST” is lit), touching a section charged with high voltage near the DUT, test lead, probe, or output terminal is dangerous.



Alligator clip
(Never touch this area when test is in progress.)

Fig. 3-3 Test lead



- The vinyl sheaths of the alligator clips of the test leads which are supplied with the tester does not have sufficient insulation for the high test voltages. Never touch them when the test is in progress.
-

3.3 Warnings after Turning OFF the Power

3.3.1 Check Items after Turning OFF the Power

If you have to touch the DUT, test leads, probes, and/or output terminals and their vicinities for re-connections or other reasons, be sure of the following two matters:

- The output voltmeter indicates “0.”
- The DANGER lamp has turned OFF.

When you have tested the DUT with the DC output of the tester, the DUT will remain charged at the high test voltage. For details, see section 3.3.2, “Residual High Voltages (TOS5051A Only)” on Page 3-5 .

3.3.2 Residual High Voltages (TOS5051A Only)

Warning for Residual High Voltages

When you perform a test with the DC output, the DUT, test leads, probes, and output terminals and their vicinities are charged up to high voltages. Even after you turn off the DC output, these voltages remain there for a period that depends on the conditions of the test. Within this period, never touch the DUT, test leads, probes, or output terminals or their vicinities to avoid electric shock.

When touching a section charged with high voltage, check the following:

- The output voltmeter indicates “0”.
- The DANGER lamp has turned OFF.

Checking the Discharge

The time necessary for the residual high voltage to be discharged varies depending on test conditions--such as the properties of the DUT and the test voltage delivered by tester.

Table 3-1 indicates the time it takes to discharge the internal capacitor when the DUT is not connected (on the tester alone).

If a DUT is connected, the discharge time varies depending on the characteristics of the DUT.

Table 3-1 indicates the time it takes to discharge when a DUT whose capacitance is 0.05 μF is connected to the tester.

Table3-1 Discharge time

	Test voltage	Discharge time	Note
TOS5051A alone	5 kV	Approx. 16 ms	Time until the output terminal voltage of the TOS5051A attenuates to 30 V
DUT		Approx. 50 ms	Time until the DUT voltage attenuates to 30 V

The tester has an internal circuit to discharge the residual high voltage of its output circuit when the output is turned off. Do not disconnect the DUT from the tester during a test. If you do, the residual high voltage on the DUT will remain undischarged for a long period.

3.4 Warnings for Remote Control

Be extremely careful when operating the tester in the remote control mode in which the dangerous high test voltage is turned ON/OFF remotely. Provide protective means as follows:

- Provide means to assure that the test setup does not output voltage inadvertently (TEST state).
- Provide means to assure that no one can touch the DUT, test leads, probes, output terminals and their vicinities when high voltage is being output (TEST state).

3.5 Inhibitions

3.5.1 Inhibition of Rapid ON/OFF Repetitions

After turning OFF the power switch, be sure to allow several seconds or more before turning it ON again. Do not repeat the operation of turning ON/OFF the power switch rapidly. If you do, the protectors of the tester may not be able to render their protective functions properly. Do not turn OFF the power switch without turning OFF the output switch first. Do this only in case of emergency.

3.5.2 Inhibition of Shorting to Earth Ground

Pay attention so that the high test voltage line is not shorted to a nearby AC line or nearby devices (such as conveyors) which are connected to an earth ground. If it is shorted, the tester chassis can be charged up to a hazardous high voltage.

Be sure to connect the protective grounding terminal of the tester to an earth line. If this has been done correctly, the tester will not be damaged and its chassis will not be charged up to the high voltage even when the HIGH output terminal is shorted to the LOW output terminal.

For your safety, be sure to ground the tester. For a description of the grounding method, see section 2.6, "Grounding (Earth)" (Page 2-6).

3.6 Actions to Be Taken in Emergency

In case of an emergency (such as an electric shock accident or burning of the DUT), take the following actions:

- (a) Turn OFF the power switch of the tester.
- (b) Disconnect the power cord of the tester from the AC line receptacle.

You may do either (a) or (b) first. But be sure to do both.

3.7 Breakdown

3.7.1 Stopping the Use of Broken Testers

If the tester behaves as indicated below, the tester may have broken down. The tester may be in an extremely dangerous state in which the high voltage cannot be shut down. If such behavior is observed, immediately turn OFF the power switch and disconnect the power cord from the AC line receptacle. Never attempt to repair the tester by yourself. Please contact Kikusui distributor/agent.

- The DANGER lamp does not turn OFF even though you press the STOP switch.
- The DANGER lamp does not turn OFF but the pointer of the output voltmeter is deflected indicating that the output voltage is being delivered.

In other cases in which the tester is not operating properly, there is a possibility that the output voltage is delivered irrespective of your proper operating procedure. Stop using the tester immediately.

3.7.2 DANGER Lamp

Continuing to use the tester when the DANGER lamp does not light up (due to a failure of the lamp itself or other cause) when it should can lead to mistakes. This constitutes an electric shock hazard. Immediately stop using the tester and contact Kikusui distributor/agent for repair.

3.8 Wattage, Heat, and Other Limiting Conditions of Use

■ Use at a voltage less than or equal to 5 kV

The maximum output voltage of the tester when there is no load may be higher than 5 kV. It may be even higher depending on AC line voltage fluctuation. Be sure to operate the tester at an output voltage less than or equal to 5 kV.

■ Provide time for the tester to pause

During an AC test

The heat dissipation of the high voltage transformer of the AC test section is one-half of the normal wattage with respect to the rated output from the viewpoint of size, weight, and cost of the tester. When operating the tester with its UPPER CUTOFF CURRENT higher than 50 mA, provide pause periods at least identical with test periods. The maximum allowable continuous test period is 30 minutes (at ambient temperature not higher than 40 °C. If this limit is exceeded, the thermal fuse in the high voltage transformer may blow out.

The information below does not apply when the CUTOFF CURRENT is less than 50 mA.

Table 3-2 Conditions for maximum continuous test period (AC mode)

Ambient temperature t (°C)	Upper cutoff current I (mA)	Pause period	Maximum allowable continuous test period
t ≤ 40°C	50 < I ≤ 110	Not less than test periods	≤ 30 min
	I ≤ 50	Not required	Continuous

During a DC test (TOS5051A only)

The heat dissipation of the high voltage generator of the DC test section is one-tenth of the normal wattage with respect to the rated output from the viewpoint of size, weight, and cost of the tester. When operating the tester, provide pause periods shown in the tables below. If you operate the tester beyond these limits, the high voltage generator will be overheated and the protector may trip and the tester may be driven into the PROTECTION status (“PROTECTION” is lit). If this happens, pause the test operation until the tester cools off and then resume the test operation. As the tester is cooled off and the cause of the PROTECTION status is eliminated, the tester resumes its normal operating state.

Table 3-3 Conditions for maximum continuous test period (DC mode)

Ambient temperature t ($^{\circ}\text{C}$)	Upper cutoff current I (mA)	Pause period	Maximum allowable continuous test period
$t \leq 30^{\circ}\text{C}$	$6 < I \leq 11$	At least 5 times of test period	≤ 30 s
	$6 < I \leq 11$	At least 10 times of test period	≤ 60 s
	$3 < I \leq 6$	At least 4 times of test period	≤ 120 s
	$1 < I \leq 3$	At least twice of test period	≤ 120 s
	$I \leq 1$	Not required	Continuous
	Can output up to 2 mA continuously at $t < 25^{\circ}\text{C}$		
$30^{\circ}\text{C} < t \leq 35^{\circ}\text{C}$	$6 < I \leq 11$	At least 10 times of test period	≤ 15 s
	$3 < I \leq 6$	At least 4 times of test period	≤ 30 s
	$2 < I \leq 3$	At least twice of test period	≤ 60 s
	$1 < I \leq 2$	At least twice of test period	≤ 120 s
	$I \leq 1$	Not required	Continuous
$35^{\circ}\text{C} < t \leq 40^{\circ}\text{C}$	$1 < I \leq 3$	At least 10 times of test period	≤ 15 s
	$I \leq 1$	Not required	Continuous

■ **Use within the range of ± 10 % of the nominal line voltage**

The tester operates normally on an AC line voltage with an allowance of ± 10 % of the nominal line voltage. Outside this allowance range, the tester may not operate normally and may become damaged. If your utility AC line voltage is not within this range, provide appropriate means to convert it into this range.

■ **Do not operate or store the tester in direct sunlight or in high temperature, high humidity, or dusty atmosphere.**

■ **Take the capacity of the AC line into account**

The tester has a high voltage output transformer of 500 VA and will draw a large AC input current (several tens of Amperes) in the following cases:

- (a) For several tens of milliseconds before the tester detects a failure in the DUT.
- (b) For several tens of milliseconds when starting up the tester.

Take into account the capacity of the AC line and to other devices connected to the same line. Do not connect the tester to a regulated AC line which employs a current cut-off type of overcurrent protector. If the current is cut off, the tester may generate an extremely high surge voltage in its output circuit. This is very dangerous.



4



Chapter 4 Description of Front and Rear Panel Items

This chapter describes the items on the front and rear panels of the tester.

4.1 Description of Front Panel Items

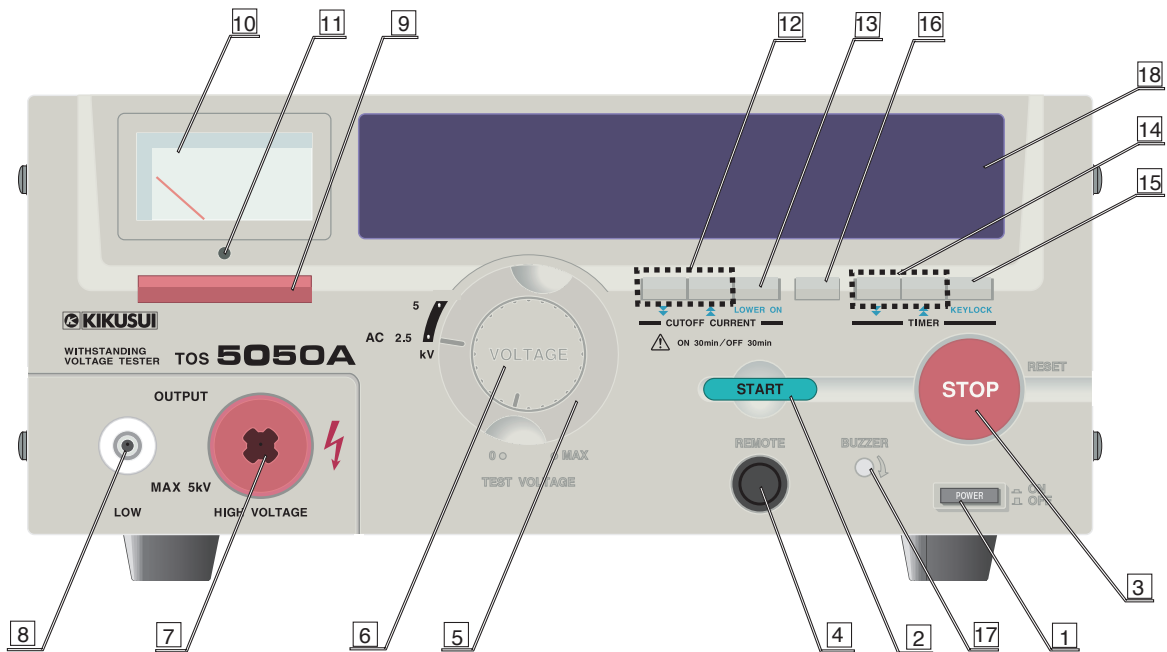

Fig.4-1 Front panel (TOS5050A)

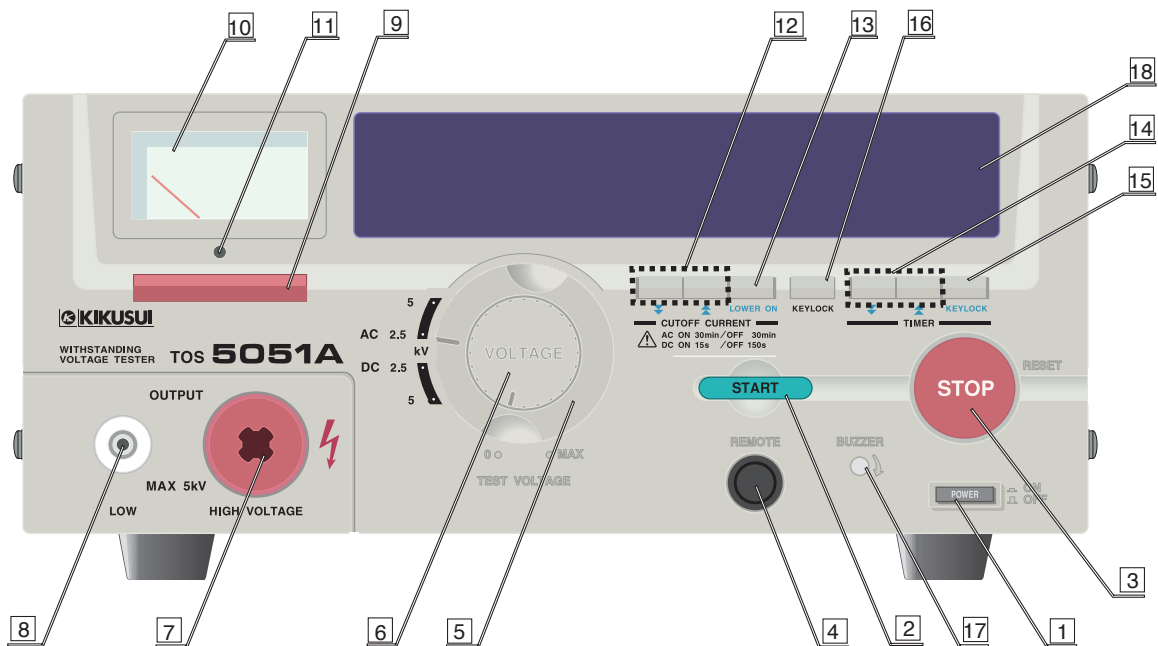

Fig. 4-2 Front panel (TOS5051A)

[1] POWER switch

The POWER switch turns ON/OFF the AC mains power of the tester.

The tester has a “resume” function. When you turn ON the POWER switch, the tester automatically resumes the conditions of test (settings of cutoff current, test period, etc.) that existed when you turned OFF the POWER switch last time.

By pressing the POWER switch while holding down the SHIFT key, you can initialize the test conditions to the initial setup (factory default setup) as shown to the right. If you do, the test conditions that existed when you turned OFF the POWER switch last time are lost.

Item	Initial setup data
Upper cutoff current	0.2 mA
Lower cutoff current	0.1 mA
Lower pass/fail judgment	OFF
Test period	0.5 s
Timer function	ON
Keylock function	OFF
Talk mode	0

NOTE

- Be sure to read Chapter 3 “Handling Precautions” (Page 3-1) of this manual before you start using the tester.
- Before turning ON the POWER switch, be sure that the TEST VOLTAGE control is at the fully counterclockwise position (“0” position).
- When you turn OFF the POWER switch immediately after you have changed the upper cutoff current, lower cutoff current or test time, no setting value may be stored. Wait for five seconds or more after the setting change, and then turn OFF the POWER switch.
- Normally, when you turn ON the POWER switch, the TESTER enters the READY state (“READY” is lit). However, the lamp will not light up in the following cases:
 1. The tester is in the PROTECTION status (“PROTECTION” is lit).
 - (a) The interlock pins of the SIGNAL I/O connector on the rear panel are open.
In this case, clear the interlock signal, reset the PROTECTION status with the STOP switch, and then start operating the tester. (For details, refer to section 6.3.3, “Interlock Function.”)
 - (b) The high voltage supply section is overheated during the DC test (TOS5051A only).
In this case, wait until the tester cools off, reset the PROTECTION status with the STOP switch, and then start operating the tester.
 2. The lower cutoff current setting is higher than the upper cutoff current setting and the lower pass/fail judgment function is ON.
In this case, make the lower cutoff current setting lower than the upper cutoff current or turn OFF the lower pass/fail judgment function and then start operating the tester.
 3. The POWER switch is turned ON when the TEST VOLTAGE switch is caught between two range positions.
The test voltage range message shows a blinking “0 kV” to notify that the setting has not been confirmed (in addition, if the TOS5051A is in the middle of switching between AC and DC, both “AC” and “DC” light up simultaneously). Because the setting has not been confirmed, “READY” turns off to notify that the tester is not in the READY status.
In this case, turn the TEST VOLTAGE switch accurately to the desired range position and then start operating the tester.

[2] START switch

If you press the START switch when the tester is in the READY state (“READY” is lit), the tester will execute the test with parameters shown on the display screen. If the “REMOTE” message is shown, the START switch is disabled and the remote start control signal applied through the REMOTE CONTROL connector or the SIGNAL I/O connector is enabled.

If the MOMENTARY switch of TEST MODE switch on the rear panel is set to ON, the test will be executed only while you hold down the START switch. For details, refer to section 6.5, “Settings for Special Test Modes” (Page 6-29).

NOTE

- Do not remote-control the tester simultaneously from both the REMOTE CONTROL connector and the SIGNAL I/O connector. If you do, the “REMOTE” message will go out and the START switch will be enabled. For details, refer to section 6.3, “Remote Control” (Page 6-20).
-

[3] STOP switch

The STOP switch is used to stop the test and reset the tester. When you press this switch, the tester will behave as follows:

1. Clear the TEST status (“TEST” is lit)

The tester will stop the test and behave as follows:

- (a) Turns OFF the output with the highest priority.
- (b) Enables the discharge function if the test is in DC mode.
- (c) Turns OFF the DANGER lamp, provided that there is no residual test voltage in the output circuit.
- (d) Turns OFF the “TEST” message.
- (e) Turns OFF the TEST signal and the HV ON signal fed through the SIGNAL I/O connector.

2. Clear the PASS status (“PASS” is lit)

The tester will clear the PASS status and behave as follows:

- (a) Turns OFF the “PASS” message.
- (b) Turns OFF the PASS signal fed through the SIGNAL I/O connector.

3. Clear the FAIL status (“FAIL” is lit)

The tester will clear the FAIL status and behave as follows:

- (a) Turns OFF the “UPPER FAIL” message.
- (b) Turns OFF the “LOWER FAIL” message.
- (c) Turns OFF the U FAIL (upper fail) signal fed through the SIGNAL I/O connector.
- (d) Turns OFF the L FAIL (lower fail) signal fed through the SIGNAL I/O connector.

4. Clear the PROTECTION status (“PROTECTION” is lit)

The tester will clear the PROTECTION status and behave follows:

- (a) Turns OFF the “PROTECTION” message.
- (b) Turns OFF the PROTECTION signal fed through the SIGNAL I/O connector.

However, the tester will not clear the PROTECTION status if the interlock pins of the SIGNAL I/O connector are open or if the high voltage supply section is overheated during a DC test (TOS5051A only). In this case, clear the interlock signal (for details refer to section 6.3.3, “Interlock Function” on Page 6-24) or wait until the tester cools off (for details, see section 6.2.4, “Setting the Test Time” on Page 6-14) and then reset the PROTECTION status with the STOP switch.

5. Clear the READY status (“READY” is lit)

The tester will clear the READY status and behave as follows:

- (a) Turns OFF the “READY” message.
- (b) Turns OFF the READY signal fed through the SIGNAL I/O connector.

Normally, when you release the STOP switch, the tester enters the READY status (“READY” is lit). In the following cases, however, the tester will not enter the READY status.

1. The cause of PROTECTION status remaining un-eliminated

- (a) The interlock pins of the SIGNAL I/O connector on the rear panel are open. (For details, refer to section 6.3.3, “Interlock Function” on Page 6-24.)
- (b) When the high voltage supply section is overheated during a DC test (TOS5051A only). (For details, refer to section 6.2.4, “Setting the Test Time.”)

2. The test voltage remaining undischarged

This is a state in which the DANGER lamp remains lighted even though the “TEST” message is OFF.

3. A period of approximately 0.5 seconds elapses after releasing the STOP switch when the DOUBLE ACTION switch of the TEST MODE switch is set to ON.

If the DOUBLE ACTION switch of the TEST MODE switch is set to ON, the tester will enter the READY state when you release the STOP switch. Then, when a period of approximately 0.5 seconds elapses, the tester will automatically clear the READY status. For details, refer to section 6.5, “Settings for Special Test Modes” (Page 6-29).

4. The STOP switch is released while the START switch is pressed.

NOTE

- If the FAIL MODE switch of the TEST MODE switch is set to ON, clearing of the FAIL status (“FAIL” is lit) or the PROTECTION status (“PROTECTION” is lit) can be done only with the STOP switch.
 - For details, refer to section 6.5, “Settings for Special Test Modes” (Page 6-29).
-

[4] REMOTE connector

This connector is used to remotely control the start/stop of the test operation from an optional device such as remote control box (RC01-TOS or RC02-TOS) or HV test probe (HP01A-TOS or HP02A-TOS).

When you connect the plug of the optional device, the remote control circuit is established, the “REMOTE” message appears, and the local START switch is disabled. In this case, the tester enters the PROTECTION status (“PROTECTION” is lit) and the high voltage output is cut off. The STOP operation can be done locally from the STOP switch on the front panel or remotely from the optional device.

When you disconnect the plug of the optional device, the “REMOTE” message disappears and the START switch is enabled. The tester enters the PROTECTION status (“PROTECTION” is lit) and the high voltage output is cut off.

WARNING • Use the optional HV test probe (HP01A-TOS or HP02A-TOS) at a test voltage of 4 kV or less in AC test mode and 5 kV or less in DC test mode.

NOTE

- When controlling the start/stop function remotely using a device other than one of the optional devices of the tester, do not use the REMOTE CONTROL connector on the front panel. Use the SIGNAL I/O connector on the rear panel, instead.
- Do not remote-control the tester simultaneously from both the REMOTE CONTROL connector and the SIGNAL I/O connector. If you do, the “REMOTE” message will disappear and the START switch will be enabled.
- If the unconditional STOP function is enabled on the remote control box, the tester will not enter the PROTECTION status when the plug of the box is connected to the REMOTE CONTROL connector. Because the unconditional STOP function is enabled on the HV test probe, the tester will not enter the PROTECTION status when the probe is connected.
- Be sure to read section 6.3, “Remote Control” (Page 6-20) before remote-controlling the tester.
- To clear the PROTECTION status, press the STOP switch.

[5] TEST VOLTAGE switch

The TEST VOLTAGE switch selects the test voltage range and switches the test mode between AC and DC (TOS5050A has no DC test mode).

Model	Selectable ranges and mode			
TOS5051A	5 kVAC	2.5 kVAC	5 kVDC	2.5 kVDC
TOS5050A	5 kVAC	2.5 kVAC	-	-

The TEST VOLTAGE switch is enabled when the tester is in the READY status (“READY” is lit); it is disabled when the tester is in the TEST-ON status (“TEST” is lit) or when the tester is delivering the result of PASS/FAIL judgment (“PASS” or “FAIL” is lit).

The tester takes approximately 0.5 seconds to respond to a range change by this switch. The test cannot be started during this period. (If the “READY” message is displayed, it disappears during this period.)

When the range you selected is entered, the TEST VOLTAGE RANGE message or the AC/DC test mode message blinks to indicate that the entry has been completed. You can clear the blinking message by pressing the STOP switch or by starting the test by pressing the START switch.

NOTE

- Before turning the TEST VOLTAGE switch, be sure that the TEST VOLTAGE control is at the fully counterclockwise position (“0” position).
- During the TEST-ON period (period that “TEST” is lit), the TEST VOLTAGE switch is disabled. During this period, it is possible that the actual position of the switch does not conform with the TEST VOLTAGE RANGE message or the AC/DC test mode message. When the test is terminated, the switch is enabled and the selected test voltage range and AC/DC mode (TOS5051A only) take effect. Do not operate the tester in this manner--that is, do not change the TEST VOLTAGE switch during the TEST-ON period.
- Do not let the TEST VOLTAGE switch get caught between two range positions. If you turn ON the POWER switch while the TEST VOLTAGE switch is caught in the middle, the test voltage range message shows a blinking “0 kV” to notify that the setting has not been confirmed (in addition, if the TOS5051A is in the middle of switching between AC and DC, both “AC” and “DC” light up simultaneously). Because the setting has not been confirmed, “READY” turns off to notify that the tester is not in the READY status. If this happens, turn the TEST VOLTAGE switch to the appropriate position.

[6] TEST VOLTAGE control

This control is used to adjust the test voltage. When you turn the control clockwise from the “0” position, the test voltage increases. The “MAX” position is for the highest test voltage corresponding to the voltage range selected by the TEST VOLTAGE switch.

On the TOS5051A, the control is for both AC and DC test modes.

Model	Selectable ranges and mode	
TOS5051A	0 kV to 5 kVAC or more	0 kV to 2.5 kVAC or more
	0 kV to 5 kVDC or more	0 kV to 2.5 kVDC or more
TOS5050A	0 kV to 5 kVAC or more	0 kV to 2.5 kVAC or more

NOTE

- Be sure to turn the TEST VOLTAGE control fully counterclockwise (“0” position) whenever you are not performing a test.
- When the TEST VOLTAGE control is set to the fully clockwise position (“MAX” position) in the no load state, the output voltage in the DC mode may be higher than the test voltage range value you selected with the TEST VOLTAGE switch. In the AC mode, the output voltage may even be higher depending on the fluctuation in the AC line voltage. Although higher voltages may be available, be sure to operate the tester with voltages lower than the corresponding range.

[7] HIGH VOLTAGE terminal

This terminal is for the high line of the tester output. The output voltage is delivered between this terminal and the LOW terminal. On the TOS5051A, this terminal serves both AC and DC test modes.

-
- ⚠ WARNING** • Never touch the HIGH VOLTAGE terminal when in the TEST-ON status (status in which the DANGER lamp lights or the “TEST” message appears).
-

[8] LOW terminal

This terminal is for the low line of the tester output. This terminal is directly connected to the tester chassis.

[9] DANGER lamp

This red lamp illuminates to indicate that the test voltage is being delivered. It remains illuminated as long as the test voltage remains in the output circuit.

-
- ⚠ WARNING** • When the DANGER lamp is illuminating, never touch the HIGH VOLTAGE terminal, test leads, DUT, or other charged objects.
-

[10] Analog voltmeter

The VOLTAGE display (analog voltmeter) indicates directly the output terminal voltage. On the TOS5051A, the voltmeter serves both AC and DC modes.

Model	Measuring Range	
TOS5051A	0 kV to 5 kVAC	0 kV to 5 kVDC
TOS5050A	0 kV to 5 kVAC	—

[11] Zero adjustment of analog voltmeter

This is the mechanical zero adjustment of the analog voltmeter. Before making a zero adjustment, be sure that the POWER switch is OFF.

[12] CUTOFF CURRENT ▲▼ keys

These keys are used to increment/decrement the cutoff currents (reference currents for pass/fail judgment). The keys are enabled when the tester is in the READY status (“READY” is lit) and the “KEYLOCK” message is OFF. They are disabled when in the TEST-ON status (“TEST” is lit) or when the tester is delivering the result of PASS/FAIL judgment (when “PASS” or “FAIL” lights).

There are two cutoff currents, upper cutoff current and lower cutoff current. You can select either cutoff current with the UP/LOW key and increment/decrement the selected cutoff current with the ▲▼ keys.

If you press either key alone, the rate of increment/decrement follows the basic resolution shown below. If you press it together with the SHIFT key, the rate of increment/decrement is ten times the basic resolution.

If you hold down the key, increment/decrement repeats automatically.

▲ key	This key increments the cutoff current setting. The setting is shown on the CURRENT display (digital ammeter).
▼ key	This key decrements the cutoff current setting. The setting is shown on the CURRENT display (digital ammeter).

UPPER/LOWER cutoff current range	Basic resolution	Display format
0.1 mA to 9.9 mA	0.1 mA	X.X mA
10 mA to 110 mA	1 mA	XXX mA

Model	AC mode test	
	Upper cutoff current range	Lower cutoff current range
TOS5051A	0.1 mA to 110 mA	0.1 mA to 110 mA, OFF
TOS5050A		

Model	DC mode test	
	Upper cutoff current range	Lower cutoff current range
TOS5051A	0.1 mA to 11 mA	0.1 mA to 11 mA, OFF
TOS5050A	—	—

NOTE

- Because the UPPER and LOWER cutoff currents can be set independently, it is possible that the latter is set to a value higher than the former. If such setting is used and the pass/fail judgment function for the LOWER cutoff current is ON, “mA” (unit of current measure) blinks and the “READY” message disappears to indicate that such test condition is not allowed. The READY status resumes if the LOWER cutoff current is set at a value lower than the UPPER cutoff current or if the pass/fail judgment function for the LOWER cutoff current is turned OFF.
On the TOS5051A, these keys are used to set the upper and lower cutoff currents for AC and DC test modes. However, the settings of cutoff currents for the AC mode and DC mode, are independent.
- When you turn OFF the POWER switch immediately after you have changed the cutoff current, no setting value may be stored. Wait for five seconds or more after the setting change, and then turn OFF the POWER switch.

[13] CUTOFF CURRENT UP/LOW key

The key selects the upper or lower cutoff current. If you press the key while holding down the SHIFT key, the lower pass/fail judgment function is turned ON or OFF.

The key is enabled when the tester is in the READY status (“READY” is lit) and the “KEYLOCK” message is OFF. It is disabled when in the TEST-ON status (“TEST” is lit) or when the tester is delivering the result of judgment (when “PASS” or “FAIL” is lit).

1. When the key alone is pressed

Each time you press the key, the upper or lower cutoff current is selected and the “UPPER” message or the “LOWER” message appears.

The “UPPER” message means that the upper cutoff current has been selected, the value is displayed on the CURRENT readout, and you can adjust the value with the ▲▼ keys.

The “LOWER” message means that the lower cutoff current has been selected, the value is displayed on the CURRENT readout, and you can adjust the value with the ▲▼ keys.

On the TOS5051A, these keys are used to set the upper and lower cutoff currents for both AC and DC test modes. However, the settings of cutoff currents for the AC mode and DC mode are independent.

2. When the UP/LOW key is pressed while holding down the SHIFT key

Each time you press the key, the “LOWER ON” message appears or disappears indicating that the lower pass/fail judgment function has been enabled or disabled.

On the TOS5051A, the lower pass/fail judgment function is turned ON or OFF with the key. This test condition is applied to both AC and DC test modes--that is, the setting for one mode applies automatically to the other mode also.

[14] TIMER ▲▼ keys

These keys are used to increment/decrement the test time. The keys are enabled when the tester is in the READY status (“READY” is lit) and the “KEYLOCK” message is OFF. They are disabled when in the TEST-ON status (“TEST” is lit) or when the tester is delivering the result of PASS/FAIL judgment (when “PASS” or “FAIL” is lit).

If you press either key alone, the rate of increment/decrement follows the basic resolution shown below. If you press it while holding down the SHIFT key, the rate of increment/decrement is ten times the basic resolution.

If you hold down the key, increment/decrement repeats automatically.

▲ key	This key increments the test period. The setting is shown on the TIME display.
▼ key	This key decrements the test period. The setting is shown on the TIME display.

Test period setting range	Basic resolution	Display format
0.5 s to 99.9 s, OFF	0.1 s	XX.X s
100 s to 999 s, OFF	1 s	XXX s

NOTE

- On the TOS5051A, the keys are used to set the test period for both AC and DC test modes. This test condition applies to both AC and DC test modes.
- When you turn OFF the POWER switch immediately after you have changed the test time, no setting value may be stored. Wait for five seconds or more after the setting change, and then turn OFF the POWER switch.

[15] TIMER ON/OFF key

The ON/OFF key turns ON or OFF the timer function.

If you press the key while holding down the SHIFT key, the keylock function is turned ON or OFF.

1. When the ON/OFF key alone is pressed

Each time you press the key, the timer function is turned ON or OFF. If you press it while the “TIMER ON” message is OFF, the timer function is turned ON and the “TIMER ON” message appears. The test done under this condition terminates when the test period indicated on the TIME display elapses.

When you press the ON/OFF key again, the timer function is turned OFF and the “TIMER ON” message disappears. In this status, the test does not terminate even when the test period indicated on the TIME display elapses. If the timer function ON during the test, the TIME display indicates the remaining period; if the timer function OFF, the TIME display indicates the elapsed period.

The ON/OFF key is enabled when the tester is in the READY status (“READY” is lit) and the “KEYLOCK” message is OFF. It is disabled when the tester is in the TEST-ON status (“TEST” is lit) or when the tester is delivering the result of PASS/FAIL judgment (When “PASS” or “FAIL” is lit).

On the TOS5051A, the ON/OFF key is used to turn ON or OFF the timer function for both AC and DC test modes. This test condition applies to both AC and DC test modes.

2. When ON/OFF key is pressed while holding down the SHIFT key

If you press the ON/OFF key while holding down the SHIFT key, the below-mentioned keys are locked and the “KEYLOCK” message appears or they are unlocked and the message disappears. If you press them again, the below-mentioned keys are unlocked and the “KEYLOCK” message disappears.

When the keylock function is ON, the following keys are locked.

- (a) CUTOFF CURRENT ▲▼ keys
- (b) CUTOFF CURRENT UP/LOW key
- (c) TIMER ▲▼ keys
- (d) TIMER ON/OFF key

Therefore, the following conditions of test can be protected against inadvertent or unauthorized alterations

- (a) Upper cutoff current
- (b) Lower cutoff current
- (c) ON/OFF of lower pass/fail judgment function
- (d) Test time
- (e) ON/OFF of timer function

If you press the ON/OFF key again while holding down the SHIFT key, the keylock function is OFF and the “KEYLOCK” message disappears.

The ON/OFF key is enabled regardless of the status of the tester.

On the TOS5051A, the keylock function applies to both AC and DC mode tests.

[16] SHIFT key

1. Press the POWER switch while holding down the SHIFT key.
The test conditions are initialized.
2. Press the CUTOFF CURRENT ▲ key while holding down the SHIFT key.
The upper or lower cutoff current is increased at a rate ten times the rate when the key is pressed alone.
3. Press the CUTOFF CURRENT ▼ key while holding down the SHIFT key.
The upper or lower cutoff current is decreased at a rate ten times the rate when the key is pressed alone.
4. Press the UP/LOW key while holding down the SHIFT key.
The lower pass/fail judgment function is turned ON or OFF.
5. Press the TIMER ▲ key while holding down the SHIFT key.
The test period is increased at a rate ten times the rate when the key is pressed alone.
6. Press the TIMER ▼ key while holding down the SHIFT key.
The test period is decreased at a rate ten times the rate when the key is pressed alone.
7. Press the ON/OFF key while holding down the SHIFT key.
The keylock function is turned ON or OFF.

[17] BUZZER control

The BUZZER control is used to adjust the loudness of the buzzer that annunciates the results of pass/fail judgments. FAIL annunciations are louder than PASS annunciations. By default, this control is set to the maximum loudness.

[18] Vacuum fluorescent display

The vacuum fluorescent display indicates test conditions, test results, and other items. For details, see section 4.2, "Display Items" on Page 4-13.

4.2 Display Items

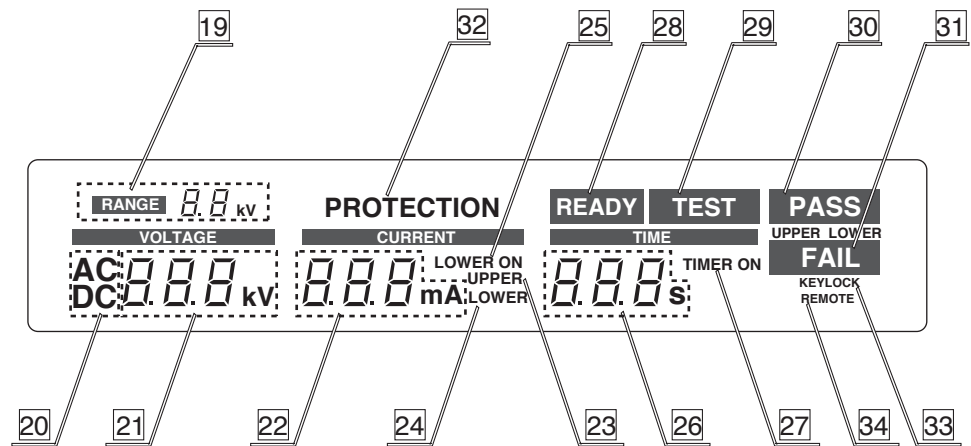

Fig. 4-3 Fluorescent display

[19] TEST VOLTAGE RANGE message

This message, which is a 7-segment 2-digit message, indicates the test voltage range selected with the TEST VOLTAGE switch. The selectable test voltage ranges are 5 kV or 2.5 kV.

NOTE

- When you change test voltage ranges with the TEST VOLTAGE switch, the TEST VOLTAGE RANGE message blinks to indicate that the ranges have been changed. Blinking stops when you press the STOP switch or when you start the test by pressing the START switch.
- During the TEST-ON period (period that the “TEST” message appears), the TEST VOLTAGE switch is disabled. During this period, it is possible that the actual position of the switch does not conform with the TEST VOLTAGE RANGE message or the AC/DC test mode message.
- Do not let the TEST VOLTAGE switch get caught between two range positions. If you turn ON the POWER switch while the TEST VOLTAGE switch is caught in the middle, the test voltage range message shows a blinking “0 kV” to notify that the setting has not been confirmed (in addition, if the TOS5051A is in the middle of switching between AC and DC, both “AC” and “DC” light up simultaneously). If this happens, turn the TEST VOLTAGE switch accurately to a range position. When you do so, the tester will enter the READY status (“READY” is lit). In this status, blinking stops when you press the STOP switch or when you start the test by pressing the START switch.

[20] AC/DC test mode message

This message indicates whether the AC or DC test mode has been selected with the TEST VOLTAGE switch. The selectable modes are AC or DC.

NOTE

- The TOS5050A only has the AC test mode. It has no DC test mode message.
- When you change the modes with the TEST VOLTAGE switch, the message blinks to indicate that the modes have been changed. Blinking stops when you press the STOP switch or when you start the test by pressing the START switch.
- During the TEST-ON period (period that “TEST” is lit), the TEST VOLTAGE switch is disabled. During this period, it is possible that the actual position of the switch does not conform with the TEST VOLTAGE RANGE message or the AC/DC test mode message.
- Do not let the TEST VOLTAGE switch get caught between two range positions. If you turn ON the POWER switch while the TEST VOLTAGE switch is caught in the middle, the test voltage range message shows a blinking “0 kV” to notify that the setting has not been confirmed (in addition, if the TOS5051A is in the middle of switching between AC and DC, both “AC” and “DC” light up simultaneously). The “READY” message will disappear to show that the tester is not in the READY status. If this happens, turn the TEST VOLTAGE switch accurately to a range position. When you do so, the tester will enter the READY status (“READY” is lit). In this status, blinking stops when you press the STOP switch or when you start the test by pressing the START switch.

[21] VOLTAGE readout (digital voltmeter)

The VOLTAGE display (digital voltmeter) indicates the output voltage with a 3-digit 7-segment readout. It constantly monitors the output terminal voltage.

On the TOS5051A, the digital voltmeter acts either as an AC voltmeter or a DC voltmeters according to the AC or DC mode selected by the TEST VOLTAGE switch.

1. Measuring ranges and resolutions

Model	Measuring Range		Resolution
TOS5051A	5 kVAC range	0 kV to 7.081 kV	27.77 V
	2.5 kVAC range	0 kV to 3.540 kV	13.88 V
	5 kVDC range	0 kV to 6.375 kV	25.00 V
	2.5 kVDC range	0 kV to 3.186 kV	12.50 V
TOS5050A	5 kVAC range	0 kV to 7.081 kV	27.77 V
	2.5 kVAC range	0 kV to 3.540 kV	13.88 V

2. Display formats

Voltage range	Display format
0.000 kV to 9.99 kV	X.XX kV

NOTE

- Due to the measuring resolution, the readout may not be “0.00 kV” when the output terminal voltage is zero volts.

[22] CURRENT readout (digital ammeter)

When the tester is in the TEST-ON status (“TEST” is lit), the CURRENT readout indicates the measured output current; when the tester is in other status than the TEST-ON status, it indicates the preset upper or lower cutoff current. It is a 3-digit 7-segment readout.

The display can be changed between upper and lower cutoff current settings with the UP/LOW key when the tester is in the READY status (“READY” is lit) and the “KEYLOCK” message is OFF. The “UPPER” message means that the tester is in the status for setting the upper cutoff current; the “LOWER” message means that the tester is in the status for setting the lower cutoff current.

You can increment/decrement the upper or lower cutoff current with the ▲ or ▼ key when the tester is in the READY status (“READY” is lit) and the “KEYLOCK” message is OFF. (If you press the SHIFT key at the same time, the increment/decrement rate is multiplied by 10.)

If the lower cutoff current is higher than the upper cutoff current and the lower pass/fail judgment function is ON, “mA” (unit of measure) blinks and the “READY” message disappears to alert you to that the setting is illogical and the test cannot be done. When the lower cutoff current is set lower than the higher cutoff current or when the lower pass/fail judgment function is turned OFF, the mA display automatically stops blinking and the tester resumes the READY status.

On the TOS5051A, the upper cutoff currents can be preset independently for AC test mode and DC test mode, and the lower cutoff currents also can be preset independently for AC test mode and DC test mode.

1. Displayed items

When in READY status		When in TEST-ON status
When “UPPER” is lit	When “LOWER” is lit	
Upper cutoff current	Lower cutoff current	Measured current

2. Setting ranges

Model	AC mode test	
	Upper cutoff current range	Lower cutoff current range
TOS5051A	0.1 mA to 110 mA	0.1 mA to 110 mA, OFF
TOS5050A		

Model	DC mode test	
	Upper cutoff current range	Lower cutoff current range
TOS5051A	0.1 mA to 11 mA	0.1 mA to 11 mA, OFF
TOS5050A	—	—

3. Setting resolutions and display formats

UPPER/LOWER cutoff current range	Basic resolution	Display format
0.1 mA to 9.9 mA	0.1 mA	X.X
10 mA to 110 mA	1 mA	XXX

[23] UPPER message

This message indicates that the ammeter is displaying the upper cutoff current.

Switchover between the upper and lower cutoff currents can be done with the UP/LOW key when the tester is in the READY status (“READY” is lit) and the “KEY-LOCK” message is OFF.

When the test is in progress (“TEST” is lit), “UPPER” and “LOWER” messages disappear, and the ammeter displays the measured current.

[24] LOWER message

This message indicates that the ammeter is displaying the lower cutoff current.

Switchover between the upper and lower cutoff currents can be done with the UP/LOW key when the tester is in the READY status (“READY” is lit) and the “KEY-LOCK” message is OFF.

When the test is in progress (“TEST” is lit), “UPPER” and “LOWER” messages disappear, and the ammeter displays the measured current.

[25] LOWER ON message

This message means that the lower pass/fail judgment function is ON. When the function is ON, the message appears; when it is OFF, the message disappears.

The function can be turned ON or OFF by pressing the UP/LOW key together with the SHIFT key when the tester is in the READY status (“READY” is lit) and the “KEYLOCK” message is OFF. Even when the lower pass/fail is turned OFF and the “LOWER ON” message is OFF, display and adjustment of the preset cutoff current can be done.

On the TOS5051A, this test condition setting applies both AC and DC test modes.

[26] Timer

When in the TEST-ON status (“TEST” is lit), the TIME display indicates the remaining or elapsed test time on a 3-digit 7-segment readout.

The preset test period can be increased/decreased with the ▲ or ▼ key when the tester is in the READY status (“READY” is lit) and the “KEYLOCK” message is OFF. If you press the ▲ or ▼ keys together with the SHIFT key, the increment/decrement rate is multiplied by a factor of 10.

If the timer function is ON (“TIMER ON” is lit), the displayed period decreases as test time elapses and the test terminates when the preset test period elapses. If the timer function is OFF (status that the “TIMER ON” message is OFF), the displayed period starts by zero and increases as test time elapses—the test does not terminate even when the preset test period elapses.

On the TOS5051A, the preset test period applies to both AC and DC test modes.

1. Displayed items

Displayed items		
When in READY status	When in TEST-ON status	
	“TIMER ON” appears	“TIMER ON” disappears
Period displayed	Remaining period	Elapsed period

2. Setting ranges, resolutions, and display formats

Setting range	Basic resolution	Display format
0.5 s to 99.9 s, OFF	0.1 s	XX.X
100 s to 999 s, OFF	1 s	XXX

[27] TIMER ON message

This message indicates that the TIMER function is ON. If the tester is in the TIMER-ON status (“TIMER ON” is lit), the test terminates when the preset test time elapses. If tester is in the TIMER-OFF status (status that the “TIMER ON” message is OFF), the test does not terminate even when the preset test period elapses. When in the TIMER-ON status, the TIME display indicates the remaining test period; when in the TIMER-OFF status, the TIME display indicates the elapsed test period.

The TIMER function can be turned on or off with the ON/OFF key when the tester is in the READY status (“READY” is lit) and the “KEYLOCK” message is OFF.

On the TOS5051A, the same test condition applies to both AC and DC test modes.

[28] READY message

This message means that the tester is ready to start the test operation. When you press the START switch while this message is displayed, the tester will start the test operation with the test parameters displayed on the display screen.

[29] TEST message

This message (red) means that the tester is in the TEST-ON status (status that the tester is executing the test by delivering the test voltage). To clear this status, press the STOP switch.

[30] PASS message

This message (green) appears when the result of pass/fail judgment is PASS. (It appears when the result is PASS within the test period. So it does not appear if the TIMER function is OFF or the test is aborted.)

Normally, it appears only for approximately 0.2 seconds. If you turn ON the PASS HOLD switch of the TEST MODE switch, the message is held. To reset the message from the held state, press the STOP switch.

[31] FAIL messages

UPPER FAIL message

This message (yellow) appears when the result of upper pass/fail judgment is FAIL, indicating that the leak current that flowed through the DUT was larger than the preset high limit (upper cutoff current). To reset the message, press the STOP switch.

LOWER FAIL message

This message (yellow) appears when the result of lower pass/fail judgment is FAIL, indicating that the leak current that flowed through the DUT was less than the preset low limit (lower cutoff current). To reset the message, press the STOP switch.

[32] PROTECTION message

This message (yellow) appears when the tester has tripped into the PROTECTION status and its output voltage is cut off, due to any of the causes as mentioned below. To clear the PROTECTION status, eliminate the cause of the trip and then press the STOP switch.

1. The plug is connected to or disconnected from the REMOTE CONTROL connector.
2. The status of the REMOTE ENABLE signal input pins of the SIGNAL I/O connector has changed.
3. The INTERLOCK signal input pins of the SIGNAL I/O connector are made open.
4. The high voltage supply circuit of the DC test section (TOS5051A only) is overheated.

[33] KEYLOCK message

This message appears when the keylock function is ON; it disappears when the function is OFF. The keylock function disables the following keys:

- (a) CUTOFF CURRENT ▲▼ keys
- (b) CUTOFF CURRENT UP/LOW key
- (c) TIMER ▲▼ keys
- (d) TIMER ON/OFF key

Thus, the settings of the following test conditions are protected.

- (a) Upper cutoff current
- (b) Lower cutoff current
- (c) ON/OFF of lower pass/fail judgment
- (d) Test time
- (e) ON/OFF of timer function

The keylock function can be turned ON or OFF at any time, by pressing the ON/OFF key while holding down the SHIFT key.

[34] REMOTE message

This message indicates that the tester is being remote-controlled via the REMOTE CONTROL connector or the SIGNAL I/O connector.

It also appears when a REMOTE command is received from the RS-232C interface. When this message appears, the START switch is disabled. For details, refer to section 6.3, "Remote Control" (Page 6-20).

4.3 Description of Rear Panel Items

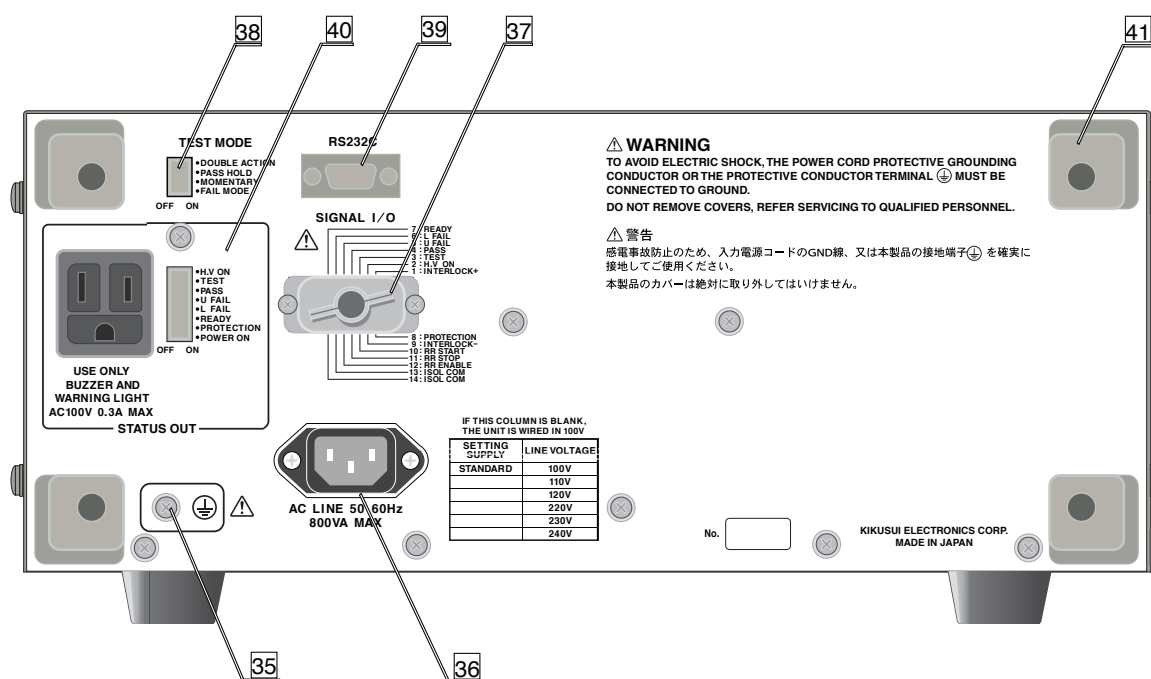

[35] Protective conductor terminal

This terminal is for grounding the tester to an earth ground.

For your safety, be sure to ground the tester. For a description of the grounding method, see section 2.6, “Grounding (Earth)” (Page 2-6).

[36] AC LINE connector

The AC LINE connector is for the AC input power.

[37] SIGNAL I/O connector

The SIGNAL I/O connector is a 14-pin Amphenol connector for the interlock input signal*, remote control signal for test start/stop, and status output signal. For details, refer to section 6.3.3, “Interlock Function” (Page 6-24) or section 6.3.2, “Remote Control through the SIGNAL I/O Connector” (Page 6-21).

NOTE

- * The Interlock signal input pin assignments are different from the old model TOS5050/5051. Therefore, the 14-pin Amphenol plug that is supplied with the tester cannot be shared between the new and old models.

[38] TEST MODE switches

The TEST MODE switches allows you to select the four test modes below. Before changing the settings of these switches, be sure to turn the POWER switch OFF.

1. DOUBLE ACTION mode
2. PASS HOLD mode
3. MOMENTARY mode
4. FAIL mode

For details, refer to section 6.5, “Settings for Special Test Modes” (Page 6-29).

[39] RS-232C connector

This connector is used to connect a RS-232C cable. Measured values and test results are output to an external device such as a PC or serial printer via the RS-232C interface.

[40] STATUS OUT receptacle and switches

The output receptacle delivers a 100 VAC signal to drive an optional warning light unit or a buzzer unit. The status signal is delivered if one of the following items is set to ON. If two or more items are set to ON, the status signal is delivered on the logical sum of such items.

- | | |
|-----------|---------------|
| 1. H.V ON | 5. L FAIL |
| 2. TEST | 6. READY |
| 3. PASS | 7. PROTECTION |
| 4. U FAIL | 8. POWER ON |

For details, refer to section 6.4, “STATUS OUT” (Page 6-28).

NOTE

- Even when the tester is operating on an AC line voltage of other than nominal 100 VAC, the signal output delivered through the STATUS OUT receptacle is 100 VAC.
-

[41] Power cord takeups

The four corrugated poles at the four corners on the rear panel are to take up the power cord when the tester is not in use.

WARNING

- The poles are for cable takeup and are not for legs of the tester. Never attempt to use the poles as legs for operating the tester in the vertical position (with its front panel faced up.). If you do, the tester will be unstable and dangerous.
-

5

Chapter 5 Preparative Test Procedures

This chapter describes the preparative procedures for test.

- **Be sure to read Chapter 3 “Handling Precautions” and observe the instructions given there.**

5.1 Initial Setup

Table 5-1 shows the initial setup (factory default setup) of the switches and knobs on the panels.

Table5-1 Factory default setup of switches and knobs

Item	Setting
POWER switch	OFF position
TEST VOLTAGE switch	2.5 kVAC range
TEST VOLTAGE control	“0” position
Zero adjustment of analog voltmeter	“0” position
BUZZER volume adjustment	Fully clockwise
TEST MODE switches	OFF for all
STATUS SIGNAL switches	OFF for all

Table 5-2 shows the initial setup (factory default setup) of the setup data stored in the internal memory of the tester.

Table 5-2 Factory default setup data

Item	Initial setup data
Upper cutoff current	0.2 mA
Lower cutoff current	0.1 mA
Lower pass/fail judgment	OFF
Test period	0.5 s
Timer function	ON
Keylock function	OFF
Talk mode	0

Procedure for the Initializing Test Setup Data

The setup data shown in Table 5-2 are saved in the internal memory of the tester. Even when the POWER switch is turned OFF, the setup data is recalled the next time the POWER switch is turned ON.

You can restore these values to factory default values (initial setup data) by carrying out the procedure below.

1. Check that the POWER switch is turned OFF.
2. Set the switches and knobs to match the initial setup.
Refer to Table 5-1.
3. Check that the power cord is correctly connected.
4. While holding down the SHIFT key, press the POWER switch.
The Vacuum Fluorescent Display will start illuminating, indicating that power has been turned ON.
5. Release both SHIFT key and POWER switch.
After several tens of seconds, the fluorescent display shows the version number, model name, and talk mode number.

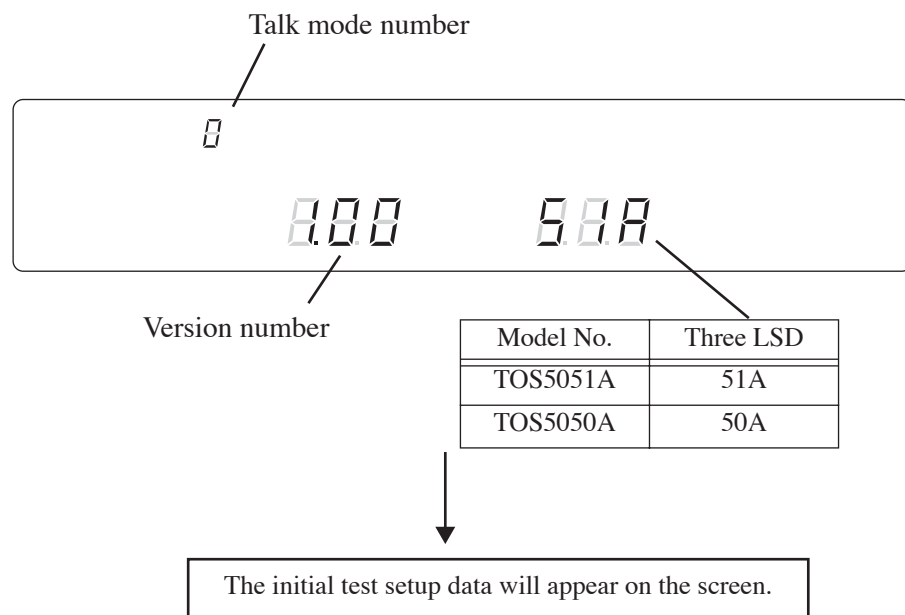

If nothing appears on the fluorescent display after one minute elapses, redo the procedure from the beginning.

-
- CAUTION** • Note that, if you initialize the test data using the above procedure, all test data that existed when you turned OFF the power of the tester last time is lost.
-

5.2 Checking the Tester Operation

The tester generates output only when the PROTECTION status (“PROTECTION” is lit) is released using the interlock function. A simple operation check is performed on the tester by connecting the 14-pin Amphenol plug that is supplied to the SIGNAL I/O connector.

Carry out the procedure below to check the operation before using the tester.

⚠ CAUTION • Note that, as you do this check, the tester is initialized with the initial test setup data and consequently the previous test setup data that existed when you turned off the POWER switch of the tester last time is lost.

1. Be sure that the POWER switch is in the OFF state.
2. Set the switches and controls on the front panel to their initial setup positions. See Fig. 5-1.
3. Check that the Amphenol plug that is supplied is not connected to the SIGNAL I/O connector on the rear panel of the tester.
4. Check that the power cord is correctly connected.
5. While holding down the SHIFT key, press the POWER switch. The vacuum fluorescent screen will start illuminating, indicating that the power has been turned ON.
6. While holding down the SHIFT key, press the POWER switch. After several tens of seconds, the fluorescent display shows the version number, model name, and talk mode number.

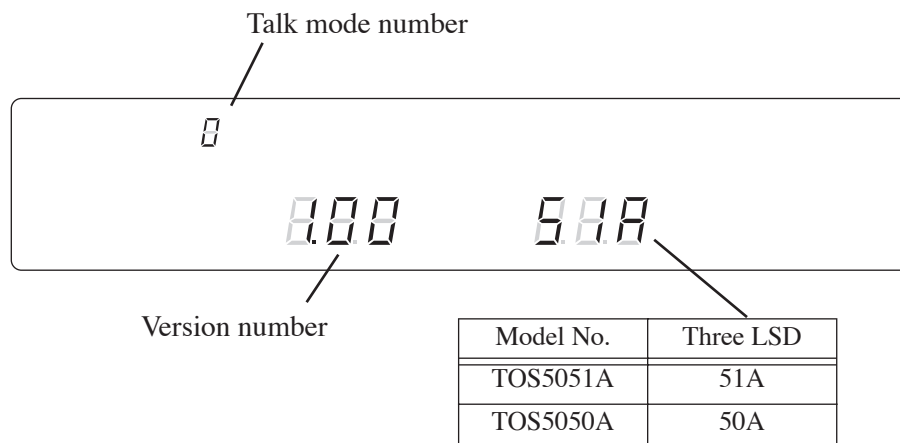

After a few more seconds, the initial test setup data will appear.

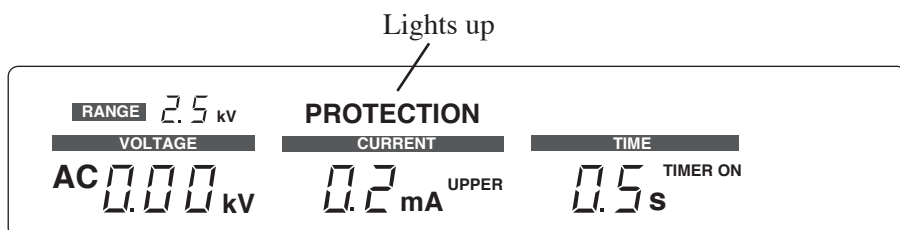

7. Check that the PROTECTION status (“PROTECTION” is lit) is enabled by the interlock function.

NOTE

- Do not let the TEST VOLTAGE switch get caught between two range positions. If you turn ON the POWER switch while the TEST VOLTAGE switch is caught in the middle, the test voltage range message shows a blinking “0 kV” to notify that the setting has not been confirmed (in addition, if the TOS5051A is in the middle of switching between AC and DC, both “AC” and “DC” light up simultaneously). If this happens, turn the TEST VOLTAGE switch accurately to a range position. As you do so, the tester will enter the READY status (status that the “READY” message appears). In this status, blinking stops as you press the STOP switch.
- The digital voltmeter may not display 0.00 kV.

8. Turn OFF the POWER switch.
9. Connect the 14-pin Amphenol connector (supplied as an accessory) to the SIGNAL I/O connector.
10. Wait at least one minute. Turn the POWER switch back ON.
After several tens of seconds, the fluorescent display shows the version number, model name, and talk mode number.
After a few more seconds, the initial test setup data will appear again.

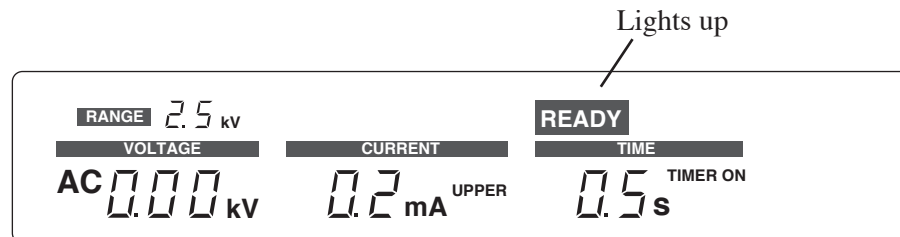

11. Check that the tester is in the READY status (“READY” is lit).

5.3 Checking the Tester before Starting Test Operation

Before starting test operation with the tester, check and adjust certain items of the tester as specified below.

1. Zero adjustment of the analog voltmeter

Before turning ON the POWER switch, check that the pointer of the analog voltmeter indicates the “0” position. If it does not, adjust it to the “0” position with the zero adjustment. If the tester power is ON when you intend this check, turn it OFF to do this check.

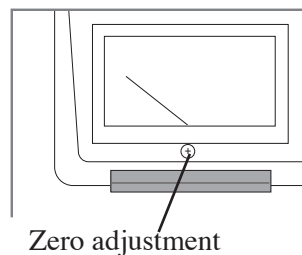

Fig.5-1 Zero adjustment of the analog voltmeter

2. Interlock function

Before start operating the tester, be sure that the test system is protected with an appropriate interlock function. (Refer to Section 6.3.3, “Interlock Function” on Page 6-24.)

3. Tester not in PROTECTION status

If the tester is in the PROTECTION status (status that the “PROTECTION” message appears), the tester will not start the test operation and will not deliver the test voltage even when you press the START switch. To reset from the PROTECTION status, eliminate the cause that has driven the tester into the PROTECTION status and then press the STOP switch. Causes that drive the tester into the PROTECTION status are as follows:

- (a) The mating connector is connected to or disconnected from the REMOTE CONTROL connector.
- (b) The status of the REMOTE ENABLE input signal pins of the SIGNAL I/O connector is altered.
- (c) The INTERLOCK input signal pins of the SIGNAL I/O connector are open.
- (d) The high voltage power supply section of the DC high voltage test section is overheated (TOS5051A only).

6

Chapter 6 Test Procedures

This chapter describes the procedures for individual types of withstanding voltage tests.

6.1 AC Withstanding Voltage Test Procedure

Set the required test parameters to test your DUT. The ranges of test parameters available are as follows:

Test voltage	Criterion for upper cutoff current	Criterion for lower cutoff current	Test time
0 kV to 5 kV	0.1 mA to 110 mA	0.1 mA to 110 mA, OFF	0.5 s to 999 s, OFF

6.1.1 Selecting an AC Test Voltage Range

With the TEST VOLTAGE switch, select an AC test voltage range (5 kV or 2.5 kV). The AC test mode message will appear, and the TEST VOLTAGE RANGE message will indicate the test voltage range you have selected.

NOTE

- Before turning the TEST VOLTAGE switch, be sure that the TEST VOLTAGE control is at the fully counterclockwise position (“0” position).
- During the TEST-ON period (period that the “TEST” message appears), the TEST VOLTAGE switch is disabled. During this period, it is possible that the actual position of the switch does not conform with the TEST VOLTAGE RANGE message or the AC/DC test mode message. When the test is terminated, the switch is enabled and the selected test voltage range and AC/DC mode (TOS5051A only) take effect. Do not change the TEST VOLTAGE switch during the TEST-ON period.
- Do not let the TEST VOLTAGE switch get caught between two range positions. If you turn ON the POWER switch while the TEST VOLTAGE switch is caught in the middle, the test voltage range message shows a blinking “0 kV” to notify that the setting has not been confirmed (in addition, if the TOS5051A is in the middle of switching between AC and DC, both “AC” and “DC” light up simultaneously). Because the setting has not been confirmed, “READY” turns off to notify that the tester is not in the READY status. When changing the TEST VOLTAGE switch, turn it accurately to a range position.

6.1.2 Setting the Upper Cutoff Current

This procedure is to set the upper cutoff current, the criterion for pass/fail judgment on the DUT. If the leak current that flows through the DUT is larger than this limit, the DUT is judged to be FAIL.

NOTE

- Test time and pause period are limited by setting upper cutoff current. “ON 30min” of the front panel character shows a maximum test time and “OFF 30min” shows a minimum pause period. For details, refer to section 10.1, “Basic Performance” (Page 10-2).

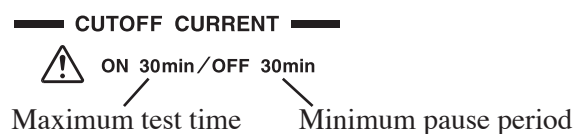

Setup procedure

1. Select the upper cutoff current setting mode with the UP/LOW key.
The “UPPER” message will appear and the preset upper limit current will be indicated on the CURRENT readout.
2. Adjust the preset upper cutoff current value as required, with the ▲ or ▼ key.
If you press the SHIFT key at the same time, the adjusting speed is increased by a factor of 10. The current value is displayed on the CURRENT readout.

Upper cutoff current setting range

0.1 mA to 110 mA

Resolution and display formats

Upper cutoff current range	Basic resolution	Display format
0.1 mA to 9.9 mA	0.1 mA	X.X mA
10 mA to 110 mA	1 mA	XXX mA

NOTE

- The keys are enabled when the tester is in the READY status (status that the “READY” message appears) and the “KEYLOCK” message is OFF. It is disabled when in the TEST-ON status (status that the “TEST” message appears) or when the tester is delivering the result of PASS/FAIL judgment (when the “PASS” message or the “FAIL” message appears).
- Because the upper and lower cutoff currents can be set independently, it is possible that the latter is set to a value higher than the former. If such setting is used and the pass/fail judgment function for the lower cutoff current is ON, “mA” (unit of current measure) blinks and the “READY” message disappears to indicate that such test condition is not allowed. The READY status resumes and the blinking stops if the lower cutoff current is set at a value lower than the upper cutoff current or if the pass/fail judgment function for the lower cutoff current is turned OFF.
- When you turn OFF the POWER switch immediately after you have changed the cutoff current, no setting value may be stored. Wait for five seconds or more after the setting change, and then turn OFF the POWER switch.

6.1.3 Setting the Lower Cutoff Current

This procedure is to set the lower cutoff current, the criterion for pass/fail judgment on the DUT. If the leak current that flows through the DUT is less than this limit, the DUT is judged to be FAIL.

If dispersion of leak currents of DUTs is within a predictable range and their lowest values are within the range detectable with the tester, you may set the low cutoff current at a value slightly less than the lowest leak currents. By this setting, you can discriminate DUTs whose leak currents are exceptionally small and can guard against open-circuiting of the test leads, thereby improving the reliability of test. If this setting is inconvenient for your test, you can turn OFF the lower pass/fail judgment function.

Setup procedure

1. Select the lower cutoff current setting mode with the UP/LOW key.
The “LOWER” message will appear, and the preset lower limit current will be indicated on the CURRENT readout.
2. Adjust the preset lower cutoff current value as required, with the ▲ or ▼ key.
If you press the SHIFT key at the same time, the adjusting speed is increased by a factor of 10. The current value is displayed on the CURRENT readout.
3. While holding down the SHIFT key, press the UP/LOW key and the lower pass/fail judgment function will be brought into effect and the “LOWER ON” message will appear.

Lower cutoff current setting range

0.1 mA to 110 mA, OFF

Resolutions and display formats

Lower cutoff current range	Basic resolution	Display format
0.1 mA to 9.9 mA	0.1 mA	X.X mA
10 mA to 110 mA	1 mA	XXX mA

NOTE

- The keys are enabled when the tester is in the READY status (status that the “READY” message appears) and the “KEYLOCK” message is OFF. It is disabled when in the TEST-ON status (status that the TEST message appears) or when the tester is delivering the result of PASS/FAIL judgment (when the “PASS” message or the “FAIL” message appears).
 - Because the upper and lower cutoff currents can be set independently, it is possible that the latter is set to a value higher than the former. If such setting is used and the pass/fail judgment function for the lower cutoff current is ON, “mA” (unit of current measure) blinks and the “READY” message disappears to indicate that such test condition is not allowed. The READY status resumes and the blinking stops if the lower cutoff current is set at a value lower than the upper cutoff current or if the pass/fail judgment function for the lower cutoff current is turned OFF.
 - When you turn OFF the POWER switch immediately after you have changed the cutoff current, no setting value may be stored. Wait for five seconds or more after the setting change, and then turn OFF the POWER switch.
 - As noted in section 10.1, “Basic Performance”, when a test is done with a high AC voltage and a high sensitivity, the lower pass/fail judgment may not be correctly done in a particular case that the output current that flows due to the stray capacitances of the output circuit (such as test leads, etc.) is larger than the preset lower cutoff current. Normally, if no DUT is connected, since no end-load current is drawn, the output current should be smaller than the preset lower cutoff current and the tester should deliver a FAIL judgment. In the above particular case, however, as the output current is larger than the preset lower cutoff current, the tester will give a PASS judgment even when no DUT is connected. Be careful when using the pass/fail judgment function. Take into consideration the various factors that can affect the reliability of judgment. Before starting tests, disconnect the DUT and be certain that the FAIL judgment is correctly done.
-

6.1.4 Setting the Test Time

This procedure is to set the test period of time during which the tester remains in the TEST-ON status (status that the tester delivers the test voltage). When this period elapses without any FAIL judgment, the tester terminates the test and gives a PASS judgment. You can turn OFF the timer function if you don't need it.

- NOTE**
- Test time and pause period are limited by setting upper cutoff current. “ON 30min” of the front panel character shows a maximum test time and “OFF 30min” shows a minimum pause period. For details, refer to section 10.1, “Basic Performance” (Page 10-2).

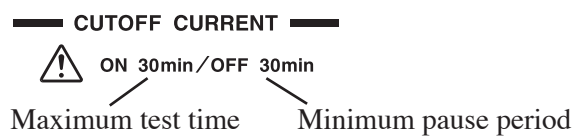

Setup procedure

1. Adjust the preset test period with the ▲ or ▼ key.
If you press the SHIFT key at the same time, the adjusting speed is increased by a factor of 10. The test period is displayed on the TIME display.
2. To turn ON (or OFF) the timer function, press the ON/OFF key.
When it is turned ON, the “TIMER ON” message appears.

Resolutions and display formats

Test period	Basic resolution	Display format
0.5 s to 99.9 s, OFF	0.1 s	XX.X
100 s to 999 s, OFF	1 s	XXX

- NOTE**
- The ON/OFF key is enabled when the tester is in the READY status (status that the “READY” message appears) and the “KEYLOCK” message is OFF. They are disabled when in the TEST-ON status (status that the “TEST” message appears) or when the tester is delivering the result of PASS/FAIL judgment (when the “PASS” message or the “FAIL” message appears).
 - The timer function is not in effect unless the “TIMER ON” message is displayed, even when the test period is displayed on the TIME display. As the timer function is not in effect, the test does not terminate even when the preset test period elapses and the tester makes no PASS judgment.
 - If your test specification requires that the test period for the DUT must not be shorter than the specified test period even by a very short period, increase the preset test period by one digit.
 - When you turn OFF the POWER switch immediately after you have changed the test time, no setting value may be stored. Wait for five seconds or more after the setting change, and then turn OFF the POWER switch.

6.1.5 Setting the Test Voltage

This procedure is to set the test voltage (output voltage of the tester) to be applied to the DUT.

NOTE

- To get the stable test voltage (output voltage), the tester should be connected to the stable AC power supply. From the tester's internal circuit configuration of view in the AC withstanding voltage test, the output voltage is affected by fluctuations of the AC power supply.
-

Setup procedure

1. Turn OFF the lower pass/fail judgment function by pressing the UP/LOW key while holding down the SHIFT key.
The "LOWER ON" message will disappear.
2. Turn OFF the timer function by pressing the ON/OFF key.
The "TIMER ON" message will disappear.
3. Check that the TEST VOLTAGE control is in the "0" position (fully counterclockwise) and that the tester is in the READY status (status that the "READY" message appears). Then, press the START switch.
4. Monitoring the output voltage on the analog voltmeter or VOLTAGE readout, raise the output voltage to the desired value by turning gradually the TEST VOLTAGE control clockwise.
5. Press the STOP switch to cut off the output voltage.
6. Turn ON the timer function by pressing the ON/OFF key.
The "TIMER ON" message will appear.
7. If you need the lower pass/fail judgment function also, press the UP/LOW key while holding down the SHIFT key.
The "LOWER ON" message will appear.

6.1.6 Connecting the DUT

Connection Procedure

1. Be sure that the analog voltmeter indicates "0" volt.
2. Be sure that the DANGER lamp has turned OFF.
3. Be sure that the "READY" message has appeared.
4. Connect the low test lead to the LOW terminal.
5. Connect the high test lead to the HIGH VOLTAGE terminal.
6. To check that the high output voltage is not being delivered, short-circuit the low test lead and high test lead.
7. Connect the low test lead to the DUT.
8. Connect the other end of the high test lead to the DUT.

6.1.7 Executing a Test

This procedure is to execute a test.

Test condition setup example

Test voltage range	5 kVAC
Test voltage	1.2 kV
Upper cutoff current	10 mA
Lower pass/fail judgment function	OFF
Test time	1 s

NOTE

- You can set the test voltage only by actually outputting the voltage. See section 6.1.5, “Setting the Test Voltage” (Page 6-6).

The items displayed when in the READY status will be as shown below.

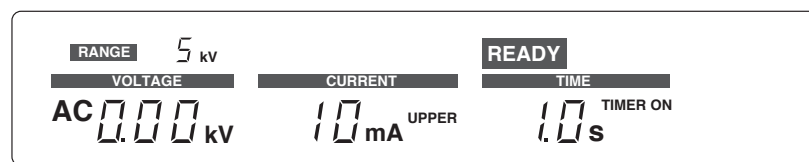

Test Procedure

- To start the test, press the START switch when the tester is in the READY status (status that the “READY” message appears).

The tester will commence the test and the following actions will take place.

- ◆ The DANGER lamp lights up.
- ◆ The H.V ON signal of the SIGNAL I/O connector is turned ON.
- ◆ The “TEST” message appears.
- ◆ The TEST signal of the SIGNAL I/O connector is turned ON.
- ◆ The test voltage is delivered between the HIGH VOLTAGE terminal and the LOW terminal.
- ◆ The analog voltmeter indicates the test voltage. (The voltmeter indicates the voltage even when the tester is not in the TEST-ON status.)
- ◆ The VOLTAGE readout displays the test voltage. (The readout displays the voltage even when the tester is not in the TEST-ON status.)
- ◆ The CURRENT readout displays the measured output current.
- ◆ The TIME display shows the remaining test time or the elapsed test time.

The Vacuum Fluorescent Display will show the following items.

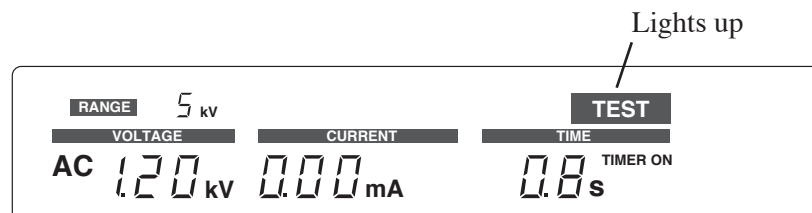

This assumes that the test voltage is 1.20 kV, the measured output current is 0.00 mA, and the remaining test time is 0.8 s.

NOTE

- The tester will not start the test if it is in the PROTECTION state.
- The tester will not start the test if a STOP signal is being applied.

If the test result is PASS

When the preset test time elapses, the tester will make a PASS judgment. If the test result is a PASS, the following actions will take place.

- ◆ The tester terminates the test and cuts off the test voltage.
- ◆ The “TEST” message disappears.
- ◆ The TEST signal of the SIGNAL I/O connector is turned OFF.
- ◆ The DANGER lamp turns OFF. (It does not go out as long as a residual test voltage remains in the output circuit.)
- ◆ The H.V ON signal of the SIGNAL I/O connector is turned OFF. (It is not turned off as long as a residual test voltage remains in the output circuit.)
- ◆ The “PASS” message appears.
- ◆ The buzzer sounds.
- ◆ The PASS signal of the SIGNAL I/O connector is turned ON.

The Vacuum Fluorescent Display in this case will be as follows:

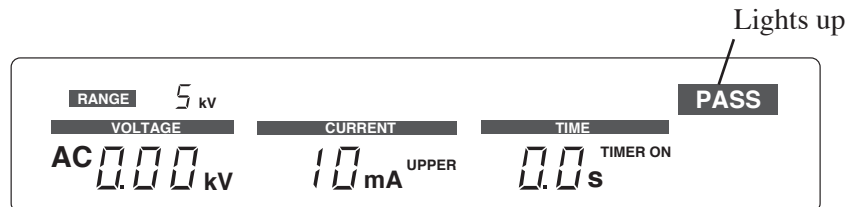

When in the normal state, the tester will automatically reset to the READY status (status that the “READY” message appears) within approximately 0.2 seconds from the PASS status and the following actions will take place.

- ◆ The “PASS” message disappears.
- ◆ The buzzer stops.
- ◆ The PASS signal of the SIGNAL I/O connector is turned OFF.

NOTE

- The tester will not automatically reset to the READY status when in any of the following cases:
 - ◆ When the PASS HOLD switch of the TEST MODE switches on the rear panel has been set to ON. In this case the PASS status is held continuously. To reset it, press the STOP switch. (For details, refer to section 6.5, “Settings for Special Test Modes” on Page 6-29 .)
 - ◆ As long as the cause of the PROTECTION status remains. (For details, refer to [32] PROTECTION message in section 4.2, “Display Items” on Page 4-18 .)
 - ◆ When the STOP switch is pressed (including the STOP switch of the remote control box).
 - ◆ When the START switch remains in the pressed state (including the START switch of the remote control box).
-

If the timer is set to OFF

If the timer function is OFF and the “TIMER ON” message is OFF, the test does not terminate automatically. You must manually stop the test by pressing the STOP switch. In this case the tester does not make the PASS judgment and the following actions will take place.

- ◆ The tester terminates the test and cuts off the test voltage.
- ◆ The “TEST” message disappears.
- ◆ The TEST signal of the SIGNAL I/O connector is turned OFF.
- ◆ The DANGER lamp turns OFF. (It does not go out as long as a residual test voltage remains in the output circuit.)
- ◆ The H.V ON signal of the SIGNAL I/O connector is turned OFF. (It is not turned off as long as a residual test voltage remains in the output circuit.)

If the test result is FAIL

If the leak current measured during the test is beyond the limits shown below, the tester will give a FAIL judgment and cut off the test voltage and terminate the test.

When the measured current is larger than the upper cutoff current:

The items shown on the Vacuum Fluorescent Display will be as follows.

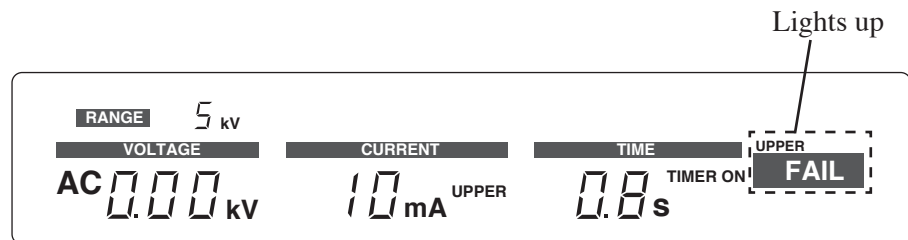

In this case, the “UPPER FAIL” message will appear.

When the measured current is less than the lower cutoff current:

Assuming that the lower cutoff current is set at 1 mA and the lower pass/fail judgment function is ON, the items shown on the Vacuum Fluorescent Display will be as follows.

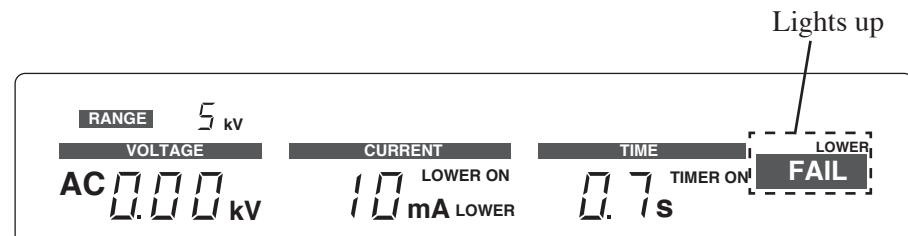

When the tester has made a FAIL judgment, the “LOWER FAIL” message will appear.

The following actions will take place.

- ◆ The tester terminates the test and cuts off the test voltage.
- ◆ The “TEST” message disappears.
- ◆ The TEST signal of the SIGNAL I/O connector is turned OFF.
- ◆ The DANGER lamp turns OFF. (It does not go out as long as a residual test voltage remains in the output circuit.)
- ◆ The H.V ON signal of the SIGNAL I/O connector is turned OFF. (It is not turned off as long as a residual test voltage remains in the output circuit.)
- ◆ The “UPPER FAIL” or “LOWER FAIL” message appears.
- ◆ Turn ON the U FAIL signal and L FAIL signal of the SIGNAL I/O connector.
- ◆ The buzzer sounds.

The FAIL judgment does not reset automatically. To reset it, press the STOP switch.

Repeating the test

Within approximately 0.2 seconds after the test was successfully terminated with a PASS judgment, the tester will automatically reset to the READY status, allowing you to repeat the test simply by pressing the START switch. The same applies also when the tester is controlled remotely.

NOTE

- The tester will not automatically reset to the READY status when in any of the following cases:
 - ◆ When the PASS HOLD switch of the TEST MODE switches on the rear panel has been set to ON. (For details, refer to section 6.5, “Settings for Special Test Modes” on Page 6-29 .)
 - ◆ As long as the cause of the PROTECTION status remains. (For details, refer to [32] PROTECTION message in section 4.2, “Display Items” on Page 4-18 .)
 - ◆ When the STOP switch is pressed (including the STOP switch of the remote control box).
 - ◆ When the START switch remains in the pressed state (including the START switch of the remote control box).

When the test is terminated with a FAIL judgment, press the STOP switch to reset the tester to the READY status and then press the START switch. The same applies also when the tester is controlled remotely.

6.2 DC Withstanding Voltage Test Procedure (TOS5051A Only)

Set the required test parameters to test your DUTs. The ranges of test parameters available with the tester are as follows:

Test voltage	Criterion for upper cutoff current	Criterion for lower cutoff current	Test time
0 kV to 5 kV	0.1 mA to 11 mA	0.1 mA to 11 mA, OFF	0.5 s to 999 s, OFF

6.2.1 Selecting a DC Test Voltage Range

With the TEST VOLTAGE switch, select a DC test voltage range (5 kV or 2.5 kV). The DC test mode message will appear, and the TEST VOLTAGE RANGE message will indicate the test voltage range you have selected.

NOTE

- Before turning the TEST VOLTAGE switch, be sure that the TEST VOLTAGE control is at the fully counterclockwise position (“0” position).
 - During the TEST-ON period (period that the “TEST” message appears), the TEST VOLTAGE switch is disabled. During this period, it is possible that the actual position of the switch does not conform with the TEST VOLTAGE RANGE message or the AC/DC test mode message. When the test is terminated, the switch is enabled and the selected test voltage range and AC/DC mode take effect. Do not change the TEST VOLTAGE switch during the TEST-ON period.
 - Do not let the TEST VOLTAGE switch get caught between two range positions. If you turn ON the POWER switch while the TEST VOLTAGE switch is caught in the middle, the test voltage range message shows a blinking “0 kV” to notify that the setting has not been confirmed (in addition, if the tester is in the middle of switching between AC and DC, both “AC” and “DC” light up simultaneously). Because the setting has not been confirmed, “READY” turns off to notify that the tester is not in the READY status. When changing the TEST VOLTAGE switch, turn it accurately to a range position.
-

6.2.2 Setting the Upper Cutoff Current

This procedure sets the upper cutoff current, the criterion for pass/fail judgment on the DUT. If the leak current is larger than this limit, the DUT is judged to be FAIL.

NOTE

- Test time and pause period are limited by setting upper cutoff current. “ON 15s” of the front panel character shows a maximum test time and “OFF 150s” shows a minimum pause period. For details, refer to section 10.1, “Basic Performance” (Page 10-2).



Setup procedure

1. Select the upper cutoff current setting mode with the UP/LOW key.
The “UPPER” message will appear and the preset upper limit current will be indicated on the CURRENT readout.
2. Adjust the preset upper cutoff current value as required, with the ▲ or ▼ key.
If you press the SHIFT key at the same time, the adjusting speed is increased by a factor of ten. The current value is displayed on the CURRENT readout.

Upper cutoff current setting range

0.1 mA to 11 mA

Resolutions and display formats

Upper cutoff current range	Basic resolution	Display format
0.1 mA to 9.9 mA	0.1 mA	X.X mA
10 mA to 11 mA	1 mA	XXX mA

NOTE

- The keys are enabled when the tester is in the READY status (status that the “READY” message appears) and the “KEYLOCK” message is OFF. They are disabled when in the TEST-ON status (status that the “TEST” message appears) or when the tester is delivering the result of PASS/FAIL judgment (when the “PASS” message or the “FAIL” message appears).
- Because the upper and lower cutoff currents can be set independently, it is possible that the latter is set to a value higher than the former. If such setting is used and the pass/fail judgment function for the lower cutoff current is ON, “mA” (unit of current measure) blinks and the “READY” message disappears to indicate that such test condition is not allowed. The READY status resumes and the blinking stops when the lower cutoff current is set at a value lower than the upper cutoff current or when the pass/fail judgment function for the lower cutoff current is turned OFF.
- When you turn OFF the POWER switch immediately after you have changed the cutoff current, no setting value may be stored. Wait for five seconds or more after the setting change, and then turn OFF the POWER switch.

6.2.3 Setting the Lower Cutoff Current

This procedure is to set the lower cutoff current, the criterion for pass/fail judgment on the DUT. If the leak current that flows through the DUT is less than this limit, the DUT is judged to be FAIL.

If dispersion of leak currents of DUTs is within a predictable range and their lowest values are within the range detectable with the tester, you may set the low cutoff current at a value slightly less than the lowest leak currents. By this setting, you can discriminate DUTs whose leak currents are exceptionally small and can guard against open-circuiting of the test leads, thereby improving the reliability of test. If this setting is inconvenient for your test, you can turn OFF the lower pass/fail judgment function.

Setup procedure

1. Select the lower cutoff current setting mode with the UP/LOW key.
The “LOWER” message will appear and the preset lower cutoff current will be indicated on the CURRENT readout.
2. Adjust the preset lower cutoff current value as required, with the ▲ or ▼ key.
If you press the SHIFT key at the same time, the adjusting speed is increased by a factor of ten. The current value is displayed on the CURRENT readout.
3. While holding down the SHIFT key, press the UP/LOW key and the lower pass/fail judgment function will be brought into effect.
The “LOWER ON” message will appear.

Lower cutoff current setting range

0.1 mA to 11 mA, OFF

Resolutions and display formats

Lower cutoff current range	Basic resolution	Display format
0.1 mA to 9.9 mA	0.1 mA	X.X mA
10 mA to 11 mA	1 mA	XXX mA

NOTE

- The keys are enabled when the tester is in the READY status (status that the “READY” message appears) and the “KEY LOCK” message is OFF. They are disabled when in the TEST-ON status (status that the “TEST” message appears) or when the tester is delivering the result of PASS/FAIL judgment (when the “PASS” message or the “FAIL” message appears).
- Because the upper and lower cutoff currents can be set independently, it is possible that the latter is set to a value higher than the former. If such setting is used and the pass/fail judgment function for the lower cutoff current is ON, “mA” (unit of current measure) blinks and the “READY” message disappears to indicate that such test condition is not allowed. The READY status resumes and the blinking stops if the lower cutoff current is set at a value lower than the upper cutoff current or if the pass/fail judgment function for the lower cutoff current is turned OFF.
- When you turn OFF the POWER switch immediately after you have changed the cutoff current, no setting value may be stored. Wait for five seconds or more after the setting change, and then turn OFF the POWER switch.

6.2.4 Setting the Test Time

This procedure is to set the test period of time during which the tester remains in the TEST-ON status (status that the tester delivers the test voltage). When this period elapses without any FAIL judgment events, the tester terminates the test and gives a PASS judgment. You can turn OFF the timer function if you don't need it.

NOTE

- Test time and pause period are limited by setting upper cutoff current. “ON 15s” of the front panel character shows a maximum test time and “OFF 150s” shows a minimum pause period. For details, refer to section 10.1, “Basic Performance” (Page 10-2).

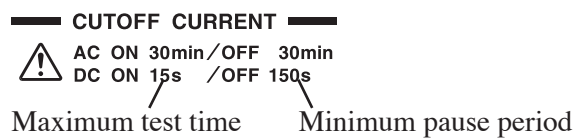

Setup procedure

1. Adjust the preset test period with the ▲ or ▼ key.
If you press the SHIFT key at the same time, the adjusting speed is increased by a factor of ten. The test period is displayed on the TIME display.
2. To turn ON (or OFF) the timer function, press the ON/OFF key.
When it is turned ON, the “TIMER ON” message appears.

Resolutions and display formats

Test period	Basic resolution	Display format
0.5 s to 99.9 s	0.1 s	XX.X
100 s to 999 s	1 s	XXX

NOTE

- The keys are enabled when the tester is in the READY status (status that the “READY” message appears) and the “KEYLOCK” message is OFF. They are disabled when in the TEST-ON status (status that the “TEST” message appears) or when the tester is delivering the result of PASS/FAIL judgment (when the “PASS” message or the “FAIL” message appears).
- The timer function is not in effect unless the “TIMER ON” message is displayed, even when the test period is displayed on the TIME display. As the timer function is not in effect, the test does not terminate even when the preset test period elapses and the tester makes no PASS judgment.
- If your test specifications require that the test period for the DUT must not be shorter than the specified test period even by a very short period, increase the preset test period by one digit.
- When you turn OFF the POWER switch immediately after you have changed the test time, no setting value may be stored. Wait for five seconds or more after the setting change, and then turn OFF the POWER switch.

6.2.5 Setting the Test Voltage

This procedure is to set the test voltage (output voltage of the tester) to be applied to the DUT.

Setup procedure

1. Turn OFF the lower pass/fail judgment function by pressing the UP/LOW key while holding down the SHIFT key.
The “LOWER ON” message will disappear.
2. Turn OFF the timer function by pressing the ON/OFF key.
The “TIMER ON” message will disappear.
3. Check that the TEST VOLTAGE control is in the “0” position (fully counterclockwise) and that the tester is in the READY status (status that the “READY” message appears). Then, press the START switch.
4. Monitoring the output voltage on the analog voltmeter or VOLTAGE readout, raise the output voltage to the desired value by turning gradually the TEST VOLTAGE control clockwise.
5. Press the STOP switch to cut off the output voltage.
6. Turn ON the timer function by pressing the ON/OFF key.
The “TIMER ON” message will appear.
7. If you need the lower pass/fail judgment function also, press the UP/LOW key while holding down the SHIFT key.
The “LOWER ON” message will appear.

6.2.6 Connecting the DUT

Setup procedure

1. Be sure that the analog voltmeter indicates “0” volt.
2. Be sure that the DANGER lamp has gone out.
3. Be sure that the “READY” message has appeared.
4. Connect the low test lead to the LOW terminal.
5. Connect the high test lead to the HIGH VOLTAGE terminal.
6. To check that the high output voltage is not being delivered, short-circuit the low test lead and high test lead.
7. Connect the low test lead to the DUT.
8. Connect the other end of the high test lead to the DUT.

6.2.7 Executing a Test

Given the following test conditions:

Test condition setup example

Test voltage range	5 kVDC
Test voltage	1.7 kV
Upper cutoff current	1 mA
Lower pass/fail judgment function	OFF
Test time	1 s

NOTE

- You can set the test voltage only by actually outputting the voltage. See section 6.2.5, “Setting the Test Voltage” (Page 6-15).

The display shown when the tester is in the READY status is as follows.

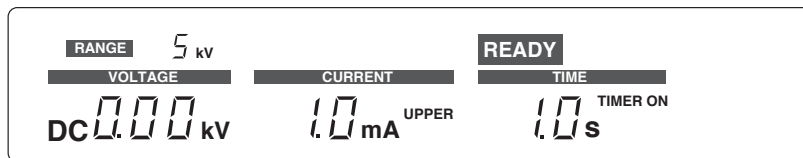

Test Procedure

- To start the test, press the START switch when the tester is in the READY status (status that the “READY” message appears).

The tester will commence the test and the following actions will take place.

- ◆ The DANGER lamp lights up.
- ◆ The H.V ON signal of the SIGNAL I/O connector is turned ON.
- ◆ The “TEST” message appears.
- ◆ The TEST signal of the SIGNAL I/O connector is turned ON.
- ◆ The test voltage is delivered between the HIGH VOLTAGE terminal and the LOW terminal.
- ◆ The analog voltmeter indicates the test voltage. (The voltmeter indicates the voltage even when the tester is not in the TEST-ON status.)
- ◆ The VOLTAGE readout displays the test voltage. (The readout displays the voltage even when the tester is not in the TEST-ON status.)
- ◆ The CURRENT readout displays the measured output current.
- ◆ The TIME display shows the remaining test time or the elapsed test time.

The Vacuum Fluorescent Display will show the following items, assuming that the test voltage is 1.70 kV, the measured output current is 0.00 mA, and the remaining test time is 0.8 s.

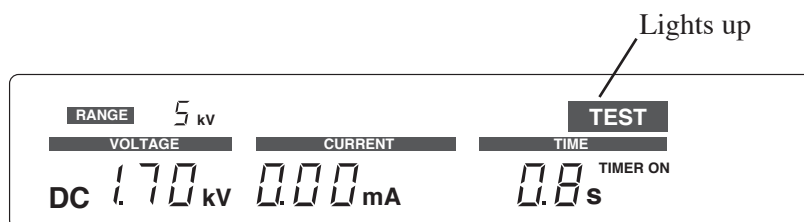

NOTE

- The tester will not start the test if it is in the PROTECTION state.
- The tester will not start the test if a STOP signal is being applied.

If the test result is PASS

When the preset test time elapses, the tester will make a PASS judgment. When the test result is a PASS, the following actions will take place.

- ◆ The tester terminates the test and cuts off the test voltage.
- ◆ The “TEST” message disappears.
- ◆ The TEST signal of the SIGNAL I/O connector is turned OFF.
- ◆ The DANGER lamp turns OFF. (It does not go out as long as a residual test voltage remains in the output circuit.)
- ◆ The H.V ON signal of the SIGNAL I/O connector is turned OFF. (It is not turned off as long as a residual test voltage remains in the output circuit.)
- ◆ The “PASS” message appears.
- ◆ The buzzer sounds.
- ◆ The PASS signal of the SIGNAL I/O connector is turned ON.

The Vacuum Fluorescent Display in this case will be as follows:

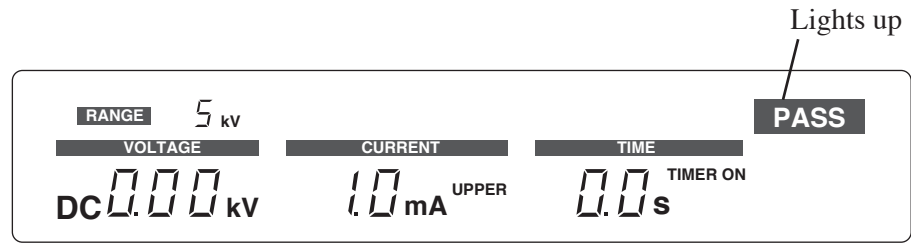

When in the normal state, the tester will automatically reset to the READY status (status that the “READY” message appears) within approximately 0.2 seconds from the PASS status and the following actions will take place.

- ◆ The “PASS” message disappears.
- ◆ The buzzer stops.
- ◆ The PASS signal of the SIGNAL I/O connector is turned OFF.

The tester will not automatically reset to the READY status in any of the following cases:

- ◆ When the PASS HOLD switch of the TEST MODE switches on the rear panel has been set to ON. In this case the PASS status is held continuously. To reset it, press the STOP switch. (For details, refer to section 6.5, “Settings for Special Test Modes” on Page 6-29 .)
- ◆ As long as the cause of the PROTECTION status remains. (For details, refer to [32] PROTECTION message in section 4.2, “Display Items” on Page 4-18 .)
- ◆ When the STOP switch is pressed (including the STOP switch of the remote control box).
- ◆ When the START switch remains in the pressed state (including the START switch of the remote control box).

If the timer functions is set to OFF

If the timer function is OFF and the “TIMER ON” message is OFF, the test does not terminate automatically. You must manually stop the test by pressing the STOP switch. In this case the tester makes no PASS judgment and the following actions will take place.

- ◆ The tester terminates the test and cuts off the test voltage.
- ◆ The “TEST” message disappears.
- ◆ The TEST signal of the SIGNAL I/O connector is turned OFF.
- ◆ The DANGER lamp turns OFF. (It does not go out as long as a residual test voltage remains in the output circuit.)
- ◆ The H.V ON signal of the SIGNAL I/O connector is turned OFF. (It is not turned off as long as a residual test voltage remains in the output circuit.)

If the test result is FAIL

If the leak current measured during the test is beyond the limits shown below, the tester will give a FAIL judgment and cut off the test voltage and terminate the test.

When the measured current is larger than the upper cutoff current:

The items shown on the Vacuum Fluorescent Display will be as follows.

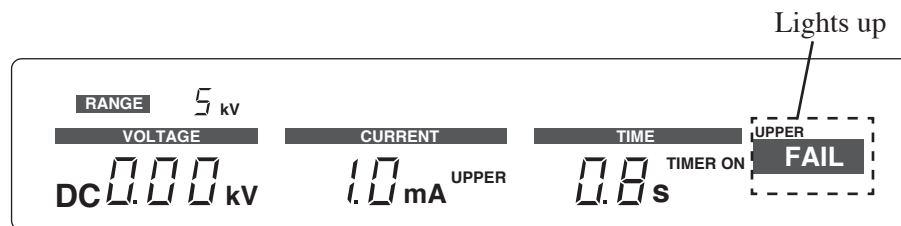

In this case, the “UPPER FAIL” message will appear.

When the measured current is less than the lower cutoff current:

Assuming that the lower cutoff current is set at 0.5 mA and the lower pass/fail judgment function is ON, the items shown on the display screen will be as follows.

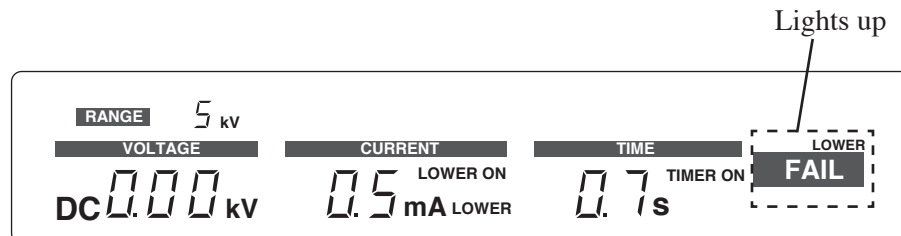

When the tester has made a FAIL judgment, the “LOWER FAIL” message will appear.

The following actions will take place.

- ◆ The tester terminates the test and cuts off the test voltage.
- ◆ The “TEST” message disappears.
- ◆ The TEST signal of the SIGNAL I/O connector is turned OFF.
- ◆ The DANGER lamp turns OFF. (It does not go out as long as a residual test voltage remains in the output circuit.)
- ◆ The H.V ON signal of the SIGNAL I/O connector is turned OFF. (It is not turned off as long as a residual test voltage remains in the output circuit.)
- ◆ The “UPPER FAIL” or “LOWER FAIL” message appears.
- ◆ The U FAIL or L FAIL signal of the SIGNAL I/O connector is turned OFF.
- ◆ The buzzer sounds.

The FAIL judgment does not reset automatically. To reset it, press the STOP switch.

Repeating the test

Within approximately 0.2 seconds after the test is successfully terminated with a PASS judgment, the tester will automatically reset to the READY status, allowing you to repeat the test simply by pressing the START switch. The same applies also when the tester is controlled remotely.

NOTE

- The tester will not automatically reset to the READY status in any of the following cases:
 - ◆ When the PASS HOLD switch of the TEST MODE switches on the rear panel has been set to ON. (For details, refer to section 6.5, “Settings for Special Test Modes” on Page 6-29 .)
 - ◆ As long as the cause of the PROTECTION status remains. (For details, refer to [32] PROTECTION message in section 4.2, “Display Items” on Page 4-18 .)
 - ◆ When the STOP switch is pressed (including the STOP switch of the remote control box).
 - ◆ When the START switch remains in the pressed state (including the START switch of the remote control box).

When the test is terminated with a FAIL judgment, press the STOP switch to reset the tester to the READY status and then press the START switch. The same applies also when the tester is controlled remotely.

6.3 Remote Control

-
- ⚠ WARNING** • Be extremely careful when operating the tester in the remote control mode in which the dangerous high test voltage is ON/OFF-controlled remotely. Provide means to assure that the tester does not enter the TEST-ON state (state that the test voltage is being delivered) by inadvertent operation. Provide means to assure that none can touch the DUT, test leads, probes, output terminals and their vicinities when in the TEST-ON state. When any of these protective functions are unavailable, do not attempt to control the tester remotely.
-

- NOTE** • **To those using the old model TOS5050/5051**
- The Interlock signal input pin assignments are different from the old model TOS5050/5051. Therefore, the 14-pin Amphenol plug that is supplied with the tester cannot be shared between the new and old models. See Table 6-2 and Fig. 6-3.
-

6.3.1 Remote Control through the REMOTE Connector

The REMOTE connector is used to turn the high voltage ON/OFF according to the signal received from the optional remote control box (RC01-TOS or RC02-TOS) or the high voltage test probe (HP01A-TOS and HP02A-TOS).

Control procedure

1. Turn OFF the POWER switch.
2. Use a dedicated cable (5-pin DIN cable) to connect the REMOTE connector on front panel to the optional device.
3. Turn ON the POWER switch.

The “REMOTE” message appears, the start input from the optional device is enabled, and the START switch on the panel is disabled. However, you can stop the voltage both from the STOP switch on the panel and the stop input from the optional device. For details, see the operation manual for the optional device.

Reverting to panel control

1. Turn OFF the POWER switch.
2. Remove the dedicated cable (5-pin DIN cable) from the REMOTE connector on the front panel.
3. Turn ON the POWER switch. The “REMOTE” message disappears and the START switch on the panel is enabled.

NOTE

- If you remove the REMOTE connector while the POWER switch is turned ON, the tester enters the PROTECTION status (“PROTECTION” is lit), and the high voltage output is shut down. However, if the forced stop function of the optional remote control box is ON, the PROTECTION status is released when the plug is inserted. In addition, because the HV test probe has a forced stop function, PROTECTION status is not enabled when the plug is inserted.
- Do not remote-control the tester simultaneously from both REMOTE CONTROL connector and SIGNAL I/O connector. If you do, the “REMOTE” message will disappear and the START switch will be enabled.
- If the FAIL MODE switch of TEST MODE switches is set to ON, the FAIL status and PROTECTION status cannot be remotely reset by applying a remote STOP signal. They must be locally reset with the STOP switch.

⚠ WARNING

- Use the optional HV test probe (HP01A-TOS or HP02A-TOS) at a test voltage of 4 kV or less in AC test mode and 5 kV or less in DC test mode.

⚠ CAUTION

- Lay the control signal wires apart (more than 500 mm) from the HV test leads and DUT. Never short the HV test lead to a signal wire. If you do, it may utterly damage the internal circuits of the tester.

6.3.2 Remote Control through the SIGNAL I/O Connector

The SIGNAL I/O connector has three functions listed below. The 14-pin Amphenol plug that is supplied is useful for connecting to the connector.

- Shut down the output in synchronization with an external device through the interlock function.
- Turn ON/OFF (Start/Stop) the high voltage from the HIGH VOLTAGE terminal from a control device other than the optional devices.
- Output the tester status using signals.

⚠ WARNING

- The 14-pin Amphenol plug that is supplied has pins 9 and 14 connected together. Be sure to provide an appropriate interlock function when using the tester. For details, refer to Section 6.3.3, “Interlock Function.”

⚠ CAUTION

- Lay the control signal wires apart (more than 500 mm) from the HV test leads and DUT. Never short the HV test lead to a signal wire. If you do, it may utterly damage the internal circuits of the tester.

SIGNAL I/O Specifications

Table6-1 Specifications of the SIGNAL I/O Signals

Item	Specifications
Input signal control section	
High-level input voltage	11 V to 15 V
Low-level input voltage	0 V to 4 V
Low-level input current	-5 mA maximum
Input time width	5 ms minimum
Isolation type	Photocoupler (30 VDC/30 VACrms MAX)
Output signal control section	
Type of output	Open collector output
Output withstanding voltage	30 VDC
Output saturation voltage	Approx. 1.1 V, at 25 °C
Maximum output current	400 mA (in total)
Isolation	Photocoupler (30 VDC/30 VACrms MAX)

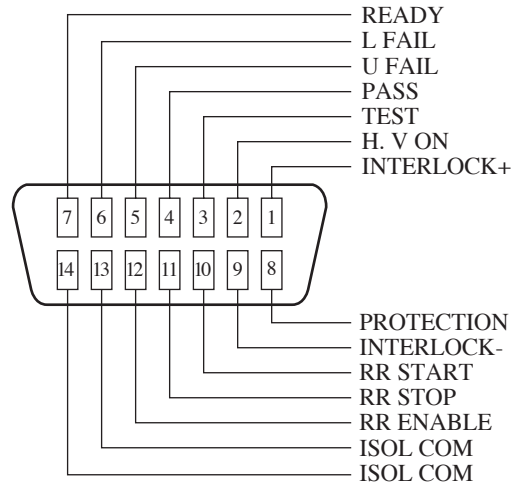

Fig.6-1 SIGNAL I/O Connector Pin layout

Table 6-2 SIGNAL I/O pin assignments

Pin No.	Signal	I/O	Output condition and signal description
1	INTERLOCK+	I	Interlock signal input pin*
2	H.V ON	O	ON while high voltage is applied across the output terminals
3	TEST	O	ON while the test is in progress
4	PASS	O	ON for approximately 0.2 s when PASS results from judgment. ON continuously when PASS HOLD is enabled.
5	U FAIL	O	ON continuously when a current above the upper cutoff current is detected and FAIL results from judgment.
6	L FAIL	O	ON continuously when a current below the lower cutoff current is detected and FAIL results from judgment.
7	READY	O	ON when ready
8	PROTECTION	O	ON when the PROTECTION function is enabled
9	INTERLOCK	I	Interlock signal input pin*
10	RR START	I	Start signal input pin
11	RR STOP	I	Stop signal input pin
12	RR ENABLE	I	Remote control enable signal input pin
13	ISOL COM		Circuit common pin
14	ISOL COM		Circuit common pin

NOTE

- * The Interlock signal input pin assignments are different from the old model TOS5050/5051. To use the Amphenol plug for the old model to this tester, you have to change the wiring between pins 9 and 14 to the wiring pins 1 and 9.

Internal construction

The signal output on the SIGNAL I/O connector is an open-collector output (see the figure), and is isolated from the internal circuit by photocouplers. However, the circuit common is shared with the input signal.

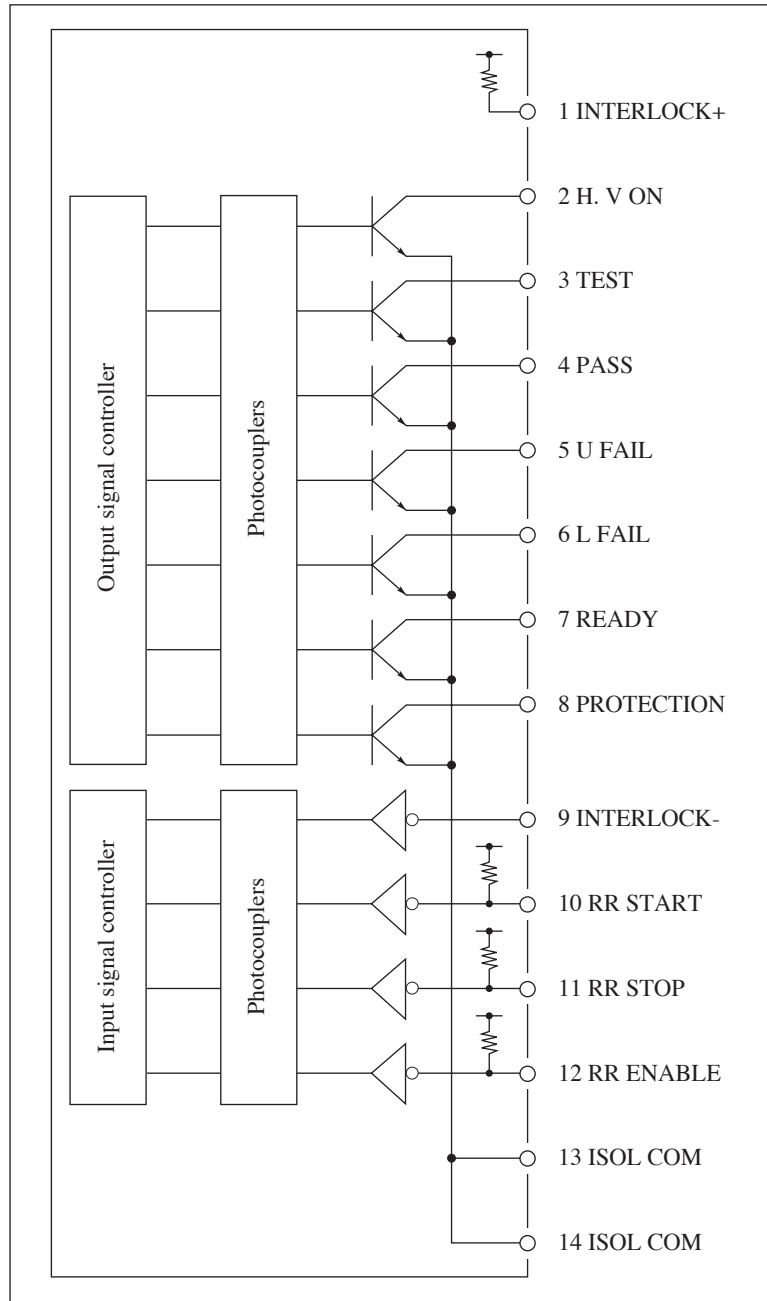

Fig. 6-2 Internal construction of the SIGNAL I/O connector

6.3.3 Interlock Function

The tester has an interlock function as a safety feature. When the interlock circuit is opened, the tester falls into the PROTECTION status (the “PROTECTION” message appears). In this status, the tester cuts off the test voltage, and does not respond to the start signal applied either locally from the START switch or remotely via the remote-control connector or to the stop signal applied either locally from the STOP switch or remotely via the remote-control connector.

Using the interlock function

Pins 1 and 9 of the SIGNAL I/O connector is the input terminal for the interlock signal. The interlock function is enabled when the circuit is made open; it is released when the circuit is closed.

To clear the PROTECTION status caused by the interlock function, turn the interlock signal to the low level and then press the STOP switch or apply a remote-controlled STOP signal.

Reference circuit

When the door opens the contact opens. Consequently, the interlock function is activated.

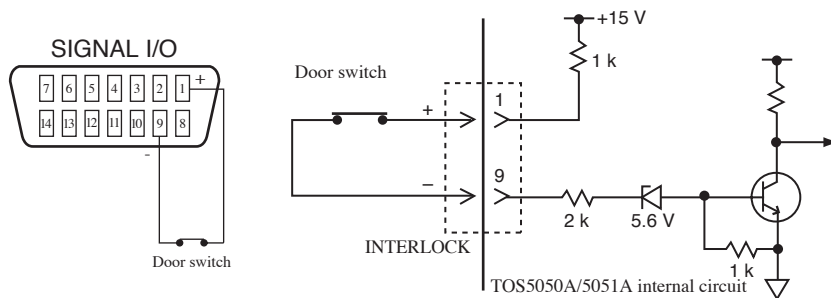

Fig. 6-3 Circuit diagram of the interlock input section



WARNING • If you turn on the power to the tester simply after taking the tester out from the box, the interlock function will be activated and the tester will not start operating.

A 14-pin Amphenol plug with pins 1 and 9 connected are supplied as an accessory to the tester. Use this plug only to release the protection temporarily.

When the tester is actually installed, use the interlock function as much as possible and furnish a safe working environment. When using special tools in the withstanding voltage test, some of the effective safety measures are to

- (1) provide a cover for the DUT to prevent electric shock,
- (2) shut down the output in synchronization with the opening of the cover, and/or
- (3) setup a safety fence around the working area and shut down the output in synchronization with the door.

6.3.4 Start/Stop Control

Pins 10, 11, and 12 of the SIGNAL I/O connector are used to remotely control start/stop.

Control procedure

1. Set pin 12, the remote control enable signal (RR ENABLE), to low level by shorting the pin to pin 13 or 14 (ISOL COM). This disables the START switch on the panel.

However, you can stop the voltage both from the STOP switch on the panel and the stop input signal (RR STOP).

2. When pin 7, the ready signal, is ON, set pin 10, the start signal (RR START), to low level by shorting the pin to pin 13 or 14 (ISOL COM). This starts the tester.
3. Set pin 11, the stop signal (RR STOP), to low level by shorting the pin to pin 13 or 14 (ISOL COM). This stops the tester.
4. To release the control, set the remote control enable signal (RR ENABLE) to high level.

The “REMOTE” message disappears, the START switch on the panel is enabled, and the start signal (RR START) of the SIGNAL I/O connector is disabled.

-
- CAUTION** • Lay the control signal wires apart (more than 500 mm) from the HV test leads and DUT. Never short the HV test lead to a signal wire. If you do, it may utterly damage the internal circuits of the tester.
-

- NOTE**
- When the remote control enable signal (RR ENABLE) is changed, the tester enters the PROTECTION status (“PROTECTION” is lit) once. Release the protection using the STOP switch on the panel or the stop signal (RR STOP).
 - Do not remote-control the tester simultaneously from both REMOTE CONTROL connector and SIGNAL I/O connector. If you do, the “REMOTE” message will disappear and the START switch will be enabled.
 - If the FAIL MODE switch of TEST MODE switches is set to ON, the FAIL status and PROTECTION status cannot be remotely reset by applying a remote STOP signal. They must be locally reset with the STOP switch
 - The input pins are pulled up to +15 V by a resistor. Opening an input pin is equivalent to entering a high level signal.
 - The internal control circuits of the tester has been designed to be resistant against interference by noise generated by the tester and its peripheral devices. However, it is not recommendable to connect non-shielded wires to the pins of the SIGNAL I/O connector. Such wires may act as antennas and may cause interference to the devices.

For the mating plug of the 14-pin Amphenol connector plug, cables, and external circuits, use a shielded metallic 14-pin Amphenol connector plug, shielded cables, and external circuits fabricated in a shielded casing. Connect the chassis of the

tester to that of the external device. (Do not connect the ISOL COM pins to the shielding line or an earth ground.) This will isolate the SIGNAL I/O circuits from the external environments and will become more resistant against noise.

- DESCRIPTION**
- Shorting of the high voltage output terminals of the tester may generate noise that can cause interference to peripheral devices. If you need to suppress the interference, connect a resistor (470 Ω or thereabout) between the end of the high test lead and the DUT and another resistor of the same resistance between the end of the low test lead and the DUT (in positions as close to the DUT as possible). These resistors are very effective for suppression of the noise interference. Pay attention to the wattage and the maximum working voltage of the resistors. When the upper cutoff current is not greater than 10 mA, resistors of 470 Ω (Rated Power: 3 W, Impulse Dielectric Withstanding Voltage: 30 kV) will be appropriate. When you have connected these resistors, the test voltage that is actually applied to the DUT will be slightly lower (approximately 10 V when the current that flows through the DUT is 10 mA) than the output terminal voltage due to the voltage drops caused by the resistors. However, it is very effective in reducing noise effects.

■ Reference start/stop circuit

When using make-contact devices

To control with make-contact devices such as relays and switches, refer to Fig. 6-4. You may replace the contacts with logic element transistors, FETs, or photocouplers.

When using logical elements

To control with logic elements (Low-active control), refer to Fig. 6-5.

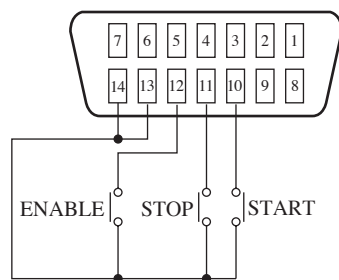

Fig. 6-4

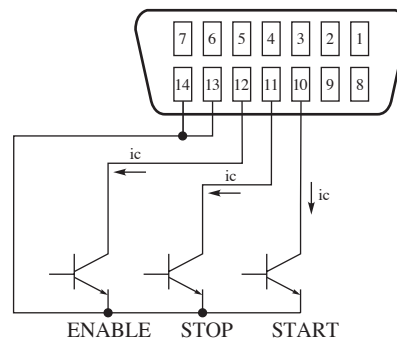

Fig. 6-5

CAUTION • Each "ic" rating must be 5 mA or more.

6.3.5 Output Signal

The tester status can be output from pins 2 to 8 of the SIGNAL I/O connector. Construct the circuit by referring to the pin assignments given in Table 6-2 and the example shown below.

When driving the relay

Drive the relay with the H.V ON signal. Refer to Fig. 6-6.

When obtaining a digital low level signal

Achieve a digital LOW level signal using the H.V ON signal. Refer to Fig. 6-7.

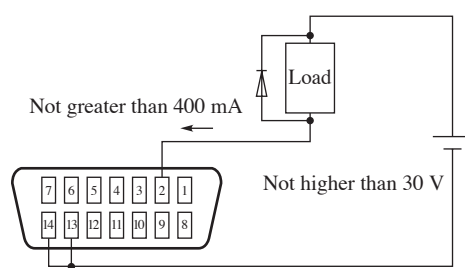

Fig. 6-6

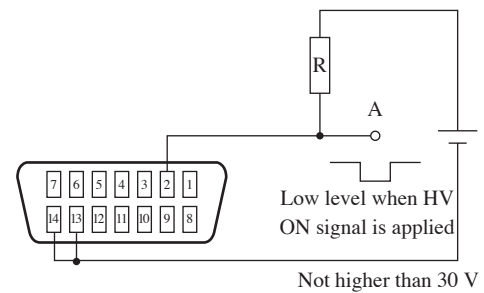

Fig. 6-7

CAUTION • Lay the control signal wires apart (more than 500 mm) from the HV test lead and DUT. Never short the HV test lead to a signal wire. If you do, it may utterly damage the internal circuits of the tester.

NOTE

- The common lines of these output signal circuits are connected to those of the input signal circuits of the SIGNAL I/O connector.
- When driving an inductive load (such as a relay), be sure to connect a diode in parallel to the coil of the load.
- The open-collector circuit elements and board can be damaged if the output circuit is shorted. It is recommended to provide a protective fuse in the output circuit.
- The internal control circuits of the tester has been designed to be resistant against interference by noise generated by the tester and its peripheral devices. However, it is not recommendable to connect non-shielded wires to the pins of the SIGNAL I/O connector. Such wires may act as antennas and may cause interference to the devices.

For the mating plug of the 14-pin Amphenol connector plug, cables, and external circuits, use a shielded metallic 14-pin Amphenol connector plug, shielded cables, and external circuits fabricated in a shielded casing. Connect the chassis of the tester to that of the external device. (Do not connect the ISOL COM pins to the shielding line or an earth ground.)

This will isolate the SIGNAL I/O circuits from the external environments and will become more resistant against noise.

6.4 STATUS OUT

This is a 100 VAC output with which to drive the optional warning light unit or the buzzer unit.

The 100 VAC output is delivered when the corresponding status has occurred if one of the DIP switches is set to ON. If two or more switches are set to ON, the status signal is delivered on the logical sum of the corresponding statuses. If you set both Switches 4 and 5 to ON, the 100 VAC output is delivered when both upper fail and lower fail have occurred simultaneously. If you set Switch 8 to ON, the 100 VAC output is delivered during the period the tester power is ON.

Table6-1 STATUS OUT signal specifications

Item	Specifications
Type of signal	Triac output
Output voltage	Approx. 100 VAC
Leak current	1 mA or less
Maximum output current	0.3 A
Isolation	Photocoupler

Table6-1 DIP switch functions

DIP switch	Condition for outputting the signal
1 H.V ON	ON while high voltage is applied across the output terminals
2 TEST	ON while the test is in progress
3 PASS	ON for approximately 0.2 s when PASS results from judgment. ON continuously when PASS HOLD is enabled.
4 U FAIL	ON continuously when a current above the upper cutoff current is detected and FAIL results from judgment.
5 L FAIL	ON continuously when a current below the lower cutoff current is detected and FAIL results from judgment.
6 READY	ON when ready
7 PROTECTION	ON when the PROTECTION function is enabled
8 POWER ON	POWER switch ON

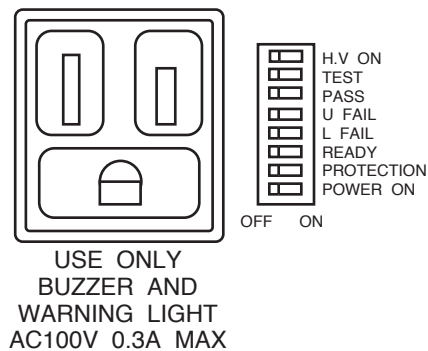

Fig. 6-8 Rear panel

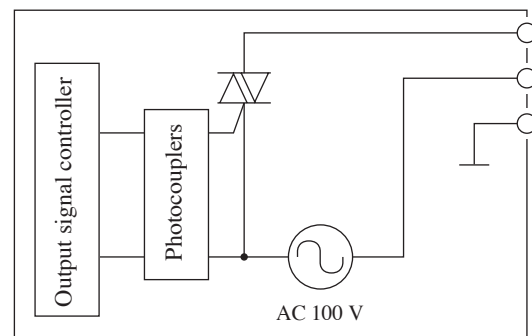

Fig. 6-9 Internal construction

CAUTION • Even when the tester is operating on an AC line voltage of other than nominal 100 VAC, the status signal output delivered through the STATUS OUT receptacle is 100 VAC.

6.5 Settings for Special Test Modes

The TEST MODE switch on the rear panel can be used to set four types of modes.

Four special test modes are selectable with the DIP switches. The factory-default settings of these switches as the tester is shipped from the factory are as shown on the right. You may select two or more modes in combination.

The tester reads the switch settings when its POWER switch is turned ON. So, when you have changed the settings, turn OFF once the POWER switch and then turn it ON again.

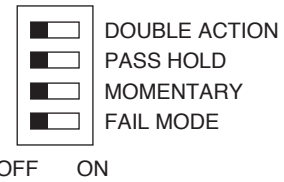

Fig. 6-10 TEST MODE switch

6.5.1 DOUBLE ACTION Switch

If you set this switch to ON, the tester does not start the test operation unless you press the START switch within approximately 0.5 seconds after releasing the STOP switch. When more than 0.5 seconds elapses, the test operation cannot be started with the START switch alone. This enhances the safety of test although the procedure is a little more sophisticated.

This function is applicable also when in the remote control mode.

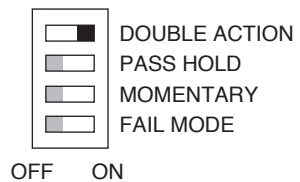

Fig. 6-11 Setting start double action

6.5.2 PASS HOLD Switch

If you set this switch to ON, the tester does not reset to the READY status within approximately 200 milliseconds after the PASS judgment is made. To reset to the READY status you need to press the STOP switch or apply a STOP signal from the remote control circuit.

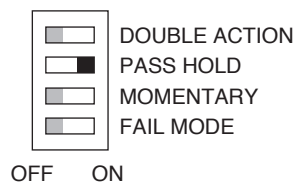
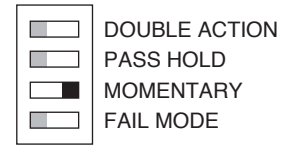

Fig. 6-12 Setting pass hold

6.5.3 MOMENTARY Switch

If you set this switch to ON, the test is executed only during the period you keep pressed the START switch. As you release the switch, the test terminates. Thus, the safety of test is enhanced.

This function is applicable also when in the remote control mode. If you use this function together with the both-hand type remote control box (RC02-TOS), the safety of test is enhanced still more.



OFF ON

Fig. 6-13 Setting momentary

6.5.4 FAIL MODE Switch

If you set this switch to ON, the tester cannot be reset from the FAIL judgment or PROTECTION status with the STOP signal applied from the remote control circuit. To reset the tester, you need to press the STOP switch.

You may use this function in order to be sure of the FAIL status or PROTECTION status when you are making tests with the optional HV test probe (HP01A-TOS or HP02A-TOS).

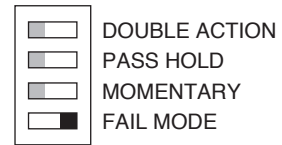

OFF ON

Fig. 6-14 Setting FAIL mode



Chapter 7 RS-232C Interface

This chapter describes the RS-232C interface.

7.1 Connecting the Cable

1. Turn OFF the POWER switch on the tester and the device to be connected.
2. Connect a cross RS-232C cable to the 9-pin RS-232C connector on the rear panel of the tester.

Fig. 7-1 shows the connector pin assignments.

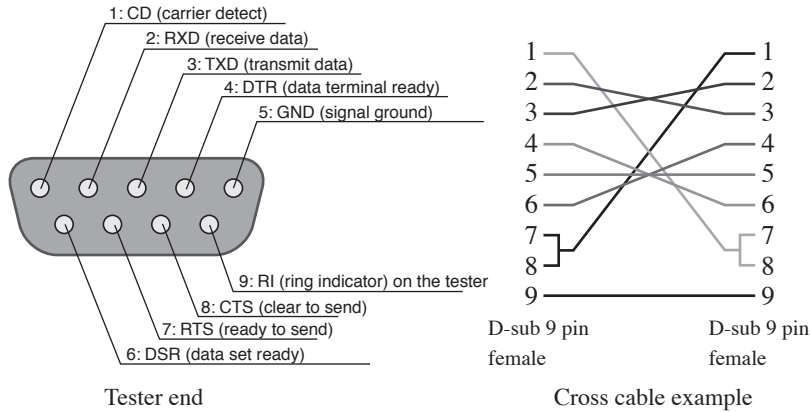

Fig. 7-1 9-pin AT type connector

7.2 RS-232C Specifications

The protocol is fixed and you cannot change it.

Table 7-1 RS-232C Specifications

Item	Specifications
Transmission system	Start-stop synchronization, half-duplex
Transmission rate	9600 bps
Data Length	8 bits
Parity	None
Stop bit	1 bit
Handshaking	None
Delimiter	When sending: CR+LF When receiving: CR, LF, or CR+LF

NOTE

- When the tester is turned on, a few bytes of characters may be transmitted from the tester. Turn on the power to the PC or serial printer after turning on the power to the tester.

7.3 Communication Method

Communication is performed using commands from the PC and responses from the tester.

One response is always returned for one command.

Commands cannot be sent continuously. Confirm the response before sending the next command.

7.4 Talk Mode

The RS-232C on the tester has four talk modes.

Table 7-2 Talk modes

Talk mode	Description	
0	Mode in which the tester responds only to commands from the PC (default setting).	
1	Mode in which the tester automatically responds when a test is started and when a test is completed. Returns only the tester status.	
	Response when a test is started	<START>
	Response when a test is completed	<PROTECT>, <PASS>, <U_FAIL>, <L_FAIL>, or <STOP>
2	Mode in which the tester automatically responds when a test is started and when a test is completed. Returns the tester status, settings, and measured values.	
	Response when a test is started	Upper cutoff current, (lower cutoff current ¹), (preset test time ²), <START>, AC or DC
	Response when a test is completed	Maximum measured voltage, maximum measured current, actual test time, and the response when the test is completed in talk mode 1
3	The operation is the same as talk mode 2, except an LF code is added when the test is completed.	

¹. The lower cutoff current is returned when the lower pass/fail judgment is enabled ("LOWER ON" is lit).

². The preset test time is returned when the timer function is enabled ("TIMER ON" is lit).

Processing on the PC is reduced in talk modes 1 to 3, since commands do not need to be sent from the PC. In addition, by connecting a serial printer to the tester, these modes allow the test log to be printed directly.

Print samples on the serial printer

Talk mode 1	Talk mode 2	Talk mode 3
<START>	U7.8mA,2.5s <START> AC	U8.0mA,2.5s <START> AC
<PASS>	930V,0.03mA,2.5s <PASS>	1307V,0.03mA,2.5s <PASS>
<START>	U7.8mA <START> AC	
<STOP>	1519V,0.03mA,12.5s <STOP>	U8.0mA,2.5s <START> AC
<START>	U7.8mA,L0.1mA <START> AC	3833V,0.03mA,2.5s <PASS>
<PROTECT>	631V,0.1mA,0.2s <L_FAIL>	
<START>	U7.8mA <START> AC	U0.8mA,3.0s <START> DC
<L_FAIL>	1708V,0.03mA,9.2s <PROTECT>	2611V,0.00mA,3.0s <PASS>
<START>	U7.8mA,2.5s <START> AC	
<U_FAIL>	856V,0.03mA,2.5s <PASS>	U0.8mA,3.0s <START> DC
<START>		4574V,0.00mA,3.0s <PASS>
<PASS>		
		U8.0mA <START> AC
		3107V,0.03mA,14.4s <STOP>
		U8.0mA,L0.1mA <START> AC
		404V,0.1mA,0.2s <L_FAIL>

Setting the talk mode

Set the talk mode according to the procedure below.

1. Check that the POWER switch is turned OFF.
2. Turn ON the POWER switch while holding down the key indicated in Table 7-3 according to the desired talk mode.

Table 7-3 Talk mode setup key

Talk mode	Front panel key
0	TIMER ON/OFF key
1	CUTOFF CURRENT ▼ key
2	CUTOFF CURRENT ▲ key
3	CUTOFF CURRENT UP/LOW key

The Vacuum Fluorescent Display will start illuminating.

3. Release the key and the POWER switch.

After several tens of seconds, the fluorescent display shows the version number, model name, and talk mode number.

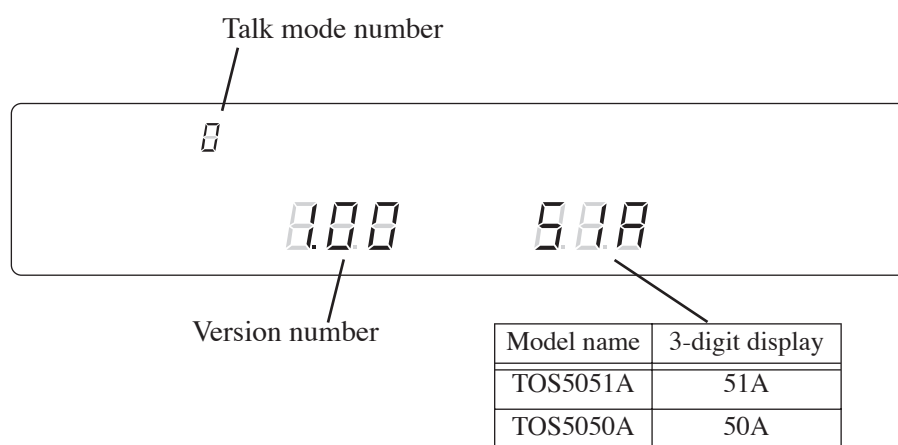

If nothing appears on the fluorescent display after one minute elapses, redo the procedure from the beginning.

4. Check that the talk mode number specified in step 2 is displayed.

NOTE • If you carry out initial setup of the data, the talk mode is set to 0. For details, see section 5.1, “Initial Setup” (Page 5-2).

7.5 Before Using the RS-232C

Maximum measured voltage and measured voltage

- The voltmeter on the front panel displays the upper 3 digits, but the RS-232C returns 4 digits.

(Example)

Response	Panel display
4991 V	4.99 kV
4999 V	4.99 kV

Maximum measured current and measured current

- If the test ends due to UPPER FAIL or LOWER FAIL, the returned current is not the measured value, but the upper cutoff current or the lower cutoff current.

Actual test time

- The maximum actual test time that can be returned is 999 seconds. 999 seconds is returned also on tests lasting longer than 1000 with the timer function turned OFF.

When the tester is set to special test modes

- When DOUBLE ACTION or MOMENTARY is turned ON using the TEST MODE switch on the rear panel, the test will not start even when a START command is sent to the tester. Turn OFF DOUBLE ACTION and MOMENTARY.

Releasing the PROTECTION status

- The PROTECTION status cannot be released using the STOP command. For a description on releasing the PROTECTION status, see , “3. Tester not in PROTECTION status” on Page 5-6 .

Test start operation and REMOTE message

- Table 7-4 indicates the enabled control sources for the various combinations of the remote control source.
- Normally, when starting the test through the RS-232C, combination “d” in Table 7-4 is the condition in which the REMOTE command is issued. However, control through the RS-232C is also enabled for combination “h” if the REMOTE command is issued.
- The REMOTE message on the display lights up only when remote control is possible.

Table 7-4 Combinations of control sources

Combination	Remote control source			START function		Display REMOTE message
	Front panel REMOTE connector	Rear panel SIGNAL I/O connector (RR ENABLE signal at low level)	RS-232C (issue the REMOTE command)	Control from the panel	Enabled remote control sources	
a				Enabled	—	OFF
b	●			Disabled	Control through the REMOTE connector and SIGNAL I/O connector are enabled	ON
c		●		Disabled	Only control through the SIGNAL I/O connector is enabled	ON
d			●	Disabled	Only RS-232C control enabled	ON
e	●	●		Enabled	None (panel only)	OFF
f		●	●	Disabled	Only control through the SIGNAL I/O connector is enabled	ON
g	●		●	Disabled	Control through the REMOTE connector and SIGNAL I/O connector are enabled	ON
h	●	●	●	Disabled	Only RS-232C control enabled	ON

7.6 RS-232C Commands and Responses

This section describes the commands that the tester supports one by one.

- Commands are not case-sensitive. Responses are returned in upper-case.
- The response for command error is ERROR.
- The command inside the parentheses is the abbreviated form of the command.

*IDN?

Queries the model name and ROM version of the tester.

Response

Returned as in the example below.

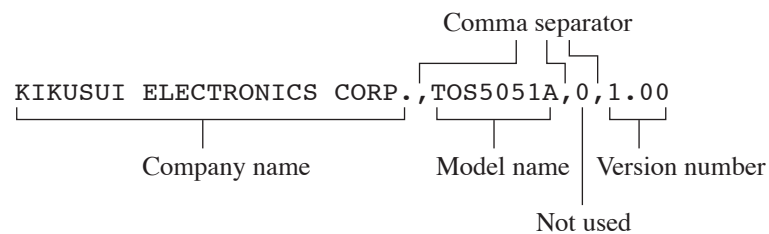

Fig. 7-2 Response example of *IDN?

*RST

Resets the tester (the talk mode is set to default (0) in this version).

Response

Returns OK.

NOTE

- The talk mode setting specified by a command is reset to the panel setting when the tester is power cycled.
-

STATUS? (STAT?)

Queries the tester status.

Response

Returns any of the following:

PROTECTION, TEST, READY, PASS, U_FAIL, L_FAIL, or ELSE

(ELSE indicates a status other than PROTECTION, TEST, READY, PASS, U_FAIL, or L_FAIL.)

MODE?

Queries the timer setting, the lower cutoff current setting, the voltage mode setting, and the voltage range setting.

Response

Returned as in the example below.

```
TIMEON,LOWEON,VOLTAC,RANG2.5  
TIMEOFF,LOWEOFF,VOLTDC,RANG5.0
```

MEASURE? (MEAS?)

Queries the measured value of the tester.

Response

The response varies when the test is in progress and when it is not.

- When the test is in progress
 - Returns the measured voltage, measured current, and actual test time.
- When the test is not in progress

Returns the result of the previous test as follows:

Returns the maximum measured voltage, maximum measured current, actual test time, and status (any of the following).

<PROTECT>, <PASS>, <U_FAIL>, <L_FAIL>, <STOP>, or <P_ON>

(<P_ON> indicates the response against the MEASURE? command immediately after the power is turned ON (condition in which the test is not performed even once).)

TMODE (TMOD)

Sets the talk mode.

Command examples

TMOD 0: Set to talk mode 0.

TMODE 1: Set to talk mode 1.

Tmode 2: Set to talk mode 2.

Response

Returns OK.

NOTE

- The talk mode setting specified by a command is reset to the panel setting when the tester is power cycled.
-

TMODE? (TMOD?)

Queries the test mode setting.

Response

Returns any of the following:

TMODE0, TMODE1, TMODE2, or TMODE3

REMOTE

Enables the START command through the RS-232C.(RS-232C REMOTE mode)

The “REMOTE” message on the panel lights.

Response

Returns OK.

NOTE

- The tester returns to LOCAL mode when the tester is power cycled.
-

LOCAL

Disables the START command through the RS-232C.(RS-232C LOCAL mode)

The “REMOTE” message on the panel turns OFF.

Response

Returns OK.

START

Starts the test.

Response

- When the START command is enabled (RS-232C REMOTE mode)
Returns OK.
- When the START command is disabled (RS-232C LOCAL mode)
Returns ERROR.

NOTE

- The START command is valid when the tester is in the RS-232C REMOTE mode (REMOTE command already issued).
-

STOP

Stops the test.

Response

Returns OK.

7.7 Sample Program

Below is a sample program using VBA.

```
Private Sub CommandButton1_Click()  
    KiUniDrv1.Connect "ASRL1"  
  
    KiUniDrv1.SetString "REMOTE"  
    TextBox2.Text = KiUniDrv1.GetString  
  
    KiUniDrv1.SetString "TMODE 0"  
    TextBox2.Text = KiUniDrv1.GetString  
  
    KiUniDrv1.SetString "START"  
    TextBox2.Text = KiUniDrv1.GetString  
  
    Call Sleep(1000)  
  
    KiUniDrv1.SetString "STOP"  
    TextBox2.Text = KiUniDrv1.GetString  
  
    KiUniDrv1.SetString "MEASURE?"  
    TextBox1.Text = KiUniDrv1.GetString  
  
    Cells(2, 5) = TextBox1.Text  
  
    KiUniDrv1.SetString "LOCAL"  
    TextBox2.Text = KiUniDrv1.GetString  
  
    KiUniDrv1.Disconnect  
  
End Sub
```

The sample program is created using the following tools.

- Kikusui Universal Instrument Driver V1.5
- Microsoft Visual Basic 6.0
- Microsoft (R) Excel 2000

8

Chapter 8 Operating Principle

This chapter describes the operating principle of the tester.

8.1 Block Diagrams

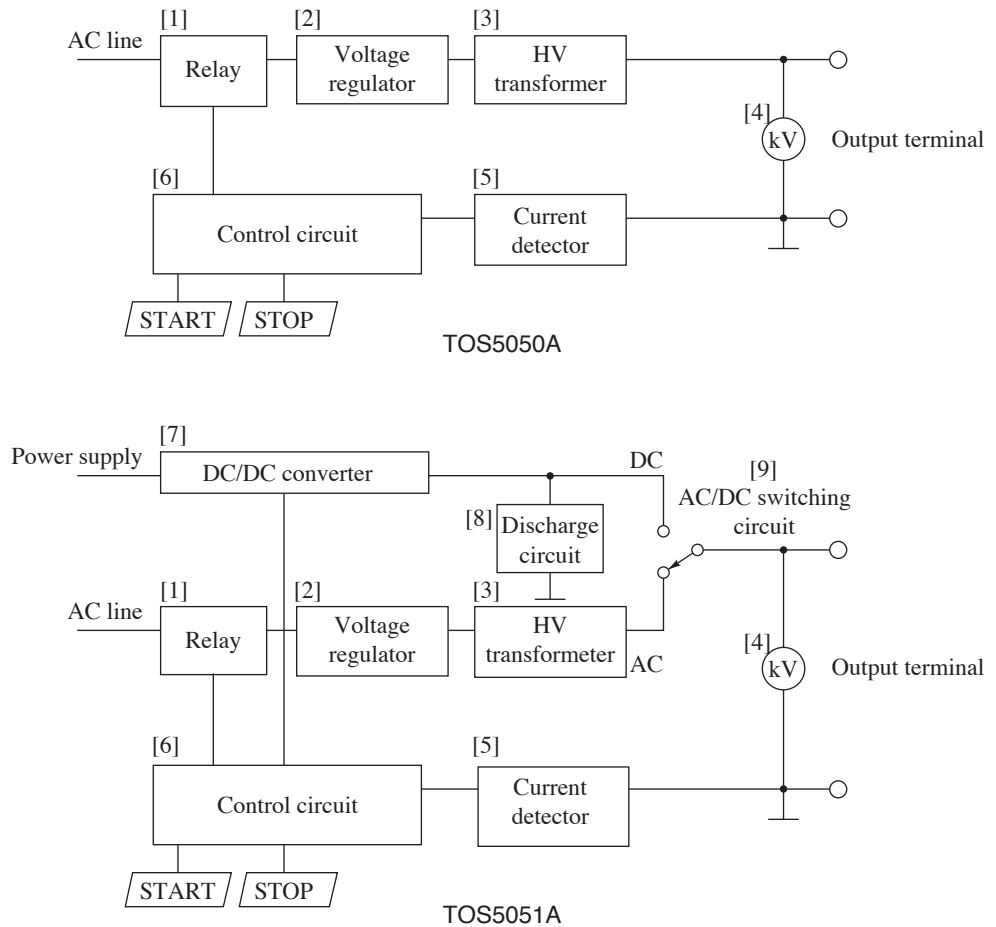

Fig. 8-1 Block diagrams

[1] Relay

The relay turns ON/OFF the line power supplied to the voltage regulator for AC withstanding voltage test. The relay employs a solid-state zero-turn-on circuit to minimize transient spike voltages caused when the relay is turned on or off.

[2] Voltage regulator

A slide transformer is used to control the output voltage.

[3] High voltage transformer

The transformer boosts the voltage regulator output with a ratio of approximately 1:25 or 1:50 into a high output voltage of 0 kV to 2.5 kV or 0 kV to 5 kV. The AC rating is 5 kV, 100 mA, 500 VA. (These stand when the AC line voltage is at its nominal voltage.)

[4] Voltmeter

The voltmeter indicates the output voltage (the voltage of the output terminal).

[5] Current detector

The current detector measures the leakage current. It consists of an absolute-value circuit, current detecting resistors, and an integrating circuit.

[6] Control circuit

The circuit controls overall operation of the tester, including voltage measurement, current measurement, pass/fail judgment, test time management, and test sequence control.

[7] DC/DC converter

The converter provides a stable high voltage for the DC test mode. The test voltage is of a positive polarity.

Its rating is 5 kV, 10 mA when the AC line voltage is at its nominal voltage.

[8] Discharge circuit

When in the DC test mode, the test leads, probe, DUT and other items connected to the output circuit can be charged up to the high DC test voltage. Even after the test is over and the test voltage is cut off, these items can remain in the charged state for a substantial period of time. The discharge circuit is to rapidly discharge the charges stored in these items. The circuit consists of a high voltage relay and a discharge resistor. The discharge resistance on the TOS5051A is 125 k Ω .

When the output voltage is cut off, the discharge circuit is automatically brought into effect and it discharges the internal output circuit of the tester, test leads, probe, and DUT.

[9] AC/DC switching circuit

This is a high voltage rotary switch which selects either the AC or DC test voltage.

8.2 Zero-turn-on Switch

If a regular mechanical contact type relay is used for on-off control operation of the primary circuit of the high voltage transformer, transient spike voltages may be produced, thereby applying an abnormal high voltage to the DUT and causing a possibility of rejecting an acceptable DUT or damaging it. The zero-turn-on switch, which employs a solid-state switching circuit, turns on and off the power line at approximately 0 volt level, thereby reducing transient overshoots.

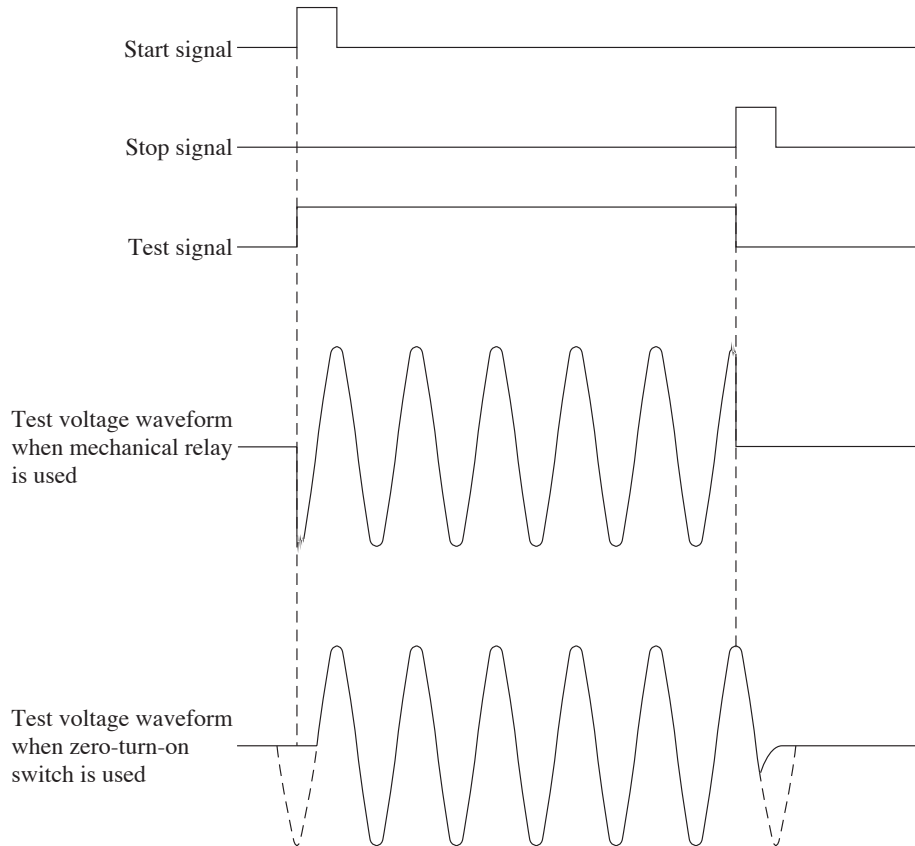

Fig. 8-2 Timing chart

-
- CAUTION** • Be sure to observe the following instructions when using a HV test probe (HP01A-TOS or HP02A-TOS). Do not connect the probe to or disconnect it from the DUT while letting it deliver the test voltage. If you do, the effects of the “zero” switching may be lost and the DUT may be damaged. Be sure to turn-on the test voltage after connecting the probe to the DUT and to disconnect the probe from the DUT after turning-off the test voltage.
-

8.3 Delay Time for Pass/Fail Judgment in DC Mode

When testing in the DC mode a DUT which has a larger capacitance, the DUT will draw a larger initial charge current. Lest the pass/fail judgment should be affected by this current, a delay time is rendered before making the pass/fail judgment. The delay time is set at approximately 0.3 seconds.

8.4 Automatic Discharge Function

When in the DC test mode, the test leads, probe, DUT and other items connected to the output circuit can be charged up to the high DC test voltage. Even after the test is over and the test voltage is cut off, these items can remain in the charged state for a substantial period of time. The discharge circuit is to rapidly discharge the charges stored in these items. When the output voltage is cut off, the discharge circuit is automatically brought into effect and it rapidly discharges the internal output circuit of the tester, test leads, probe, and DUT.



- WARNING** • Be sure to observe the following instructions when using a HV test probe (HP01A-TOS or HP02A-TOS).
Do not disconnect the probe from the DUT while letting it deliver the test voltage. If you do, the effects of the automatic discharge circuit may be lost and the items on the output circuit may remain charged up to the high test voltage. Before disconnecting the probe from the DUT, be sure that the LED on the top of the test probe has gone out.
-



9

Chapter 9 Maintenance

This chapter describes the maintenance procedures for the tester.

Periodic calibration is required to maintain the accuracy of the tester over extended time. To have your tester calibrated, contact Kikusui distributor/agent.

9.1 Cleaning

When the panels of the tester has become dirty, clean them by wiping them with a soft cloth moistened with neutral soapsuds.

⚠ WARNING • When cleaning the tester, be sure to turn OFF the POWER switch and unplug the power cord plug.

⚠ CAUTION • Do not use volatile solvents such as thinner or benzene. They may discolor the surface, erase printed characters, or cloud the display.

9.2 Checking the Cord and Leads

⚠ WARNING • If the test lead is damaged (its sheath is damaged or its core wire is open-circuited), it can cause electric shock. Never use imperfect test leads.

Checking the Power Cord

Check the power cord for broken sheath and for loose or cracked plug.

Checking the HV Test Leads

Check the high and low test leads each time before using them, in order to be sure of the following:

1. Visually inspect the leads and be sure that they have no indications of broken sheaths or other signs of damage.
2. Electrically check that the lead wires are not open-circuited (by using a circuit tester or other instrument).

9.3 Maintenance

-
- ⚠ WARNING** • The cover must be opened to replace parts. Let Kikusui service personnel take care of all replacements. If replacements are necessary, contact Kikusui distributor/agent.
-

High voltage relay

The high voltage relay of the internal discharge circuit (TOS5051A only) is a consumable component. It is recommended that the tester be overhauled every approximately 200000 repetitions of DC tests (although the service intervals may differ depending on the conditions of use). Contact Kikusui distributor/agent to have your tester overhauled.

Cooling fan

The cooling fan (TOS5051A only) is a consumable component. It is recommended that the tester be overhauled every approximately 30000 hours of run time (although the service intervals may differ depending on the conditions of use). Contact Kikusui distributor/agent to have your tester overhauled.

9.4 Calibration

Periodic calibration is required to maintain the accuracy of the tester over extended time. To have your tester calibrated, contact Kikusui distributor/agent.

-
- ⚠ WARNING** • The tester generates high voltage of 5 kV. Never attempt to calibrate the tester by yourself. For such service, contact Kikusui distributor/agent.
-



10

Chapter 10 Specifications

This chapter describes the electrical and mechanical specifications of the tester.

10.1 Basic Performance

Item		TOS5050A	TOS5051A	
Test voltage	Applied voltage		AC	AC/DC
			0 kV to 2.5 kV/0 kV to 5 kV	0 kV to 2.5 kV/0 kV to 5 kV
	AC	Output rating ¹	500 VA/5 kV, 100 mA (with nominal line voltage)	
		Transformer rating	500 VA	
		Short-circuit current ²	200 mA or more (when the output voltage is 900 V or more at 2.5 kV range or 1.3 kV or more at 5 kV range)	
		Waveform ³	AC line voltage waveform	
		Voltage regulation (with nominal line voltage)	15 % or better (against change from maximum rated load to no load)	
		Switching	With zero-turn-on (zero-start) switch	
	DC	Maximum output rating ⁴	—	50 W/5 kV, 10 mA (with nominal line voltage)
		Ripple	—	At 5 kV, no load: 50 V _{p-p} typical
—			At rated max. output: 100 V _{p-p} typical	
Voltage regulation (with nominal line voltage)		—	3 % or better (against change from maximum rated load to no load)	
Output voltmeters	Analog	Scale	AC	AC/DC common
			5 kV fs (no mirrors)	5 kV fs (no mirrors)
		Class	JIS Class 2.5	
		Accuracy	±5 % fs	
	AC indication	Mean-value response, rms-value graduation		
	Digital	Full scale	2.5 kV/5 kV fs	
		Accuracy	±1.5 % fs	
		AC response	Mean-value response, rms-value display (Response time 600 ms)	
Ammeter	Digital	Accuracy	±(5 % + 20 μA) of upper cutoff current	
		AC response	Mean-value response, rms-value display (Response time 450 ms)	

¹ Pay attention to the limitations on AC output voltage delivery time as follows: The heat dissipation of the high voltage generator section of the tester is one-half of the normal wattage with respect to the rated output from the viewpoints of size, weight, and cost of the tester. Due to this, be sure to operate the tester within the limits shown in the below tables. If you operate the tester exceeding these limits, the thermal fuse in the tester may blow out.

TOS5050A/TOS5051A			
Ambient temperature t (°C)	Upper cutoff current I (mA)	Pause period	Maximum allowable continuous test period
t ≤ 40 °C	50 < I ≤ 110	Not less than test period	≤ 30 min
	I ≤ 50	Not required	Continuous

- 2 When the nominal power supply voltage can be maintained with the output shorted.
- 3 Test voltage waveform:
When an AC test voltage is applied to a capacitive DUT, it is possible that the voltage becomes higher even than that when in the no load state. Furthermore, waveform distortion also may occur if the capacitance of the DUT is voltage-dependent (such as of ceramics capacitors). When the test voltage is not higher than 1.5 kV and the capacitance is not larger than 1000 pF, such test voltage changes are only of negligible levels.
- 4 The heat dissipation of the high voltage generator of the DC test section is one-tenth of the normal wattage with respect to the rated output from the viewpoint of size, weight, and cost of the tester. Due to this, when operating the tester, provide pause periods shown in the tables below. If you operate the tester beyond these limits, the high voltage generator will be overheated and the protector may trip and the tester may be driven into the PROTECTION status. When this has occurred, pause the test operation until the tester cools off and then resume the test operation. As the tester is cooled off and the cause of the PROTECTION status is eliminated, the tester resumes its normal operating state.

TOS5051A			
Ambient temperature t (°C)	Upper cutoff current I (mA)	Pause period	Maximum allowable continuous test period
t ≤ 30 °C	6 < I ≤ 11	At least 5 times of test period	≤ 30 s
	6 < I ≤ 11	At least 10 times of test period	≤ 60 s
	3 < I ≤ 6	At least 4 times of test period	≤ 120 s
	1 < I ≤ 3	At least twice of test period	≤ 120 s
	I ≤ 1	Not required	Continuous
	Can output up to 2 mA continuously at t < 25°C		
30 °C < t ≤ 35 °C	6 < I ≤ 11	At least 10 times of test period	≤ 15 s
	3 < I ≤ 6	At least 4 times of test period	≤ 30 s
	2 < I ≤ 3	At least twice of test period	≤ 60 s
	1 < I ≤ 2	At least twice of test period	≤ 120 s
	I ≤ 1	Not required	Continuous
35 °C < t ≤ 40 °C	1 < I ≤ 3	At least 10 times of test period	≤ 15 s
	I ≤ 1	Not required	Continuous

Item		TOS5050A	TOS5051A
Pass/fail judgment	Type of judgment	<ul style="list-style-type: none"> Window comparator type If the current detected is larger than the preset upper cutoff current, the tester gives a FAIL judgment. If the current detected is less than the preset lower cutoff current, the tester gives a FAIL judgment. As the tester gives a FAIL judgment, it cuts off the output and delivers a FAIL signal. If the test period elapses without any unacceptable conditions, the tester gives a PASS judgment. 	
	Upper cutoff current setting range	0.1 mA to 110 mAAC	0.1 mA to 110 mAAC 0.1 mA to 11 mADC
	Lower cutoff current setting range	0.1 mA to 110 mAAC	0.1 mA to 110 mAAC 0.1 mA to 11 mADC
	Judgment accuracy	$\pm(5\% + 20\ \mu\text{A})$ of upper cutoff current ⁵	
	Current detection	The absolute value of current is integrated and compared with the preset cutoff current value.	
	Calibration	Calibrated for rms value of sine wave, with pure-resistive load	
	No-load output voltage required for detection ⁶	Approx. 460 V when at 100 mAAC setting Approx. 100 V when at 10 mADC setting	
Test time	Setting range	0.5 s to 999 s	
		With Timer-off function	
	Accuracy	± 20 ms	

- ⁵ When in the AC mode, the current which flows through the stray capacitances of the test leads, test jigs, and other items on the test circuit also causes measuring errors. The total judgement accuracy is the sum of this current and the above-mentioned judgement accuracy. Approximate values of such currents are shown in the following table. Note that, in high-sensitivity high-voltage test, the current which flows through the stray capacitances may become larger than the preset lower cutoff current and the LOWER PASS/FAIL judgement may not be successfully done.

Output voltage	1 kV	2 kV	3 kV	4 kV	5 kV
When 350-mm-long test leads are used being suspended in air (typical values)	2 μA	4 μA	6 μA	8 μA	10 μA
When accessory test leads TL03-TOS are used (typical values)	16 μA	32 μA	48 μA	64 μA	80 μA

When other test leads than the above are used, the current may differ depending on the conditions of use.

- ⁶ In order to be able to make a FAIL judgement when in the state that the output terminals are shorted, a certain minimal level of no-load output voltage is necessary due to the internal resistance of the output circuit. This item indicates such minimal output voltage.

10.2 Interface and Other Functions

Item	TOS5050A/TOS5051A	
Remote control function	The tester has the following functions for remote-control of test start/stop.	
	REMOTE connector (5-pin DIN connector on the front panel)	<ul style="list-style-type: none"> To control the tester from an optional Remote control box RC01-TOS or RC02-TOS. To control the tester from an optional High voltage test probe HP01A-TOS or HP02A-TOS (when the test voltage is less than 4 kVACrms or 5 kV DC).
	SIGNAL I/O connector (14-pin Amphenol connector on the rear panel)	<ul style="list-style-type: none"> To control the tester from a make-contact device (such as a relay or a switch). To control the tester with a low-active control signal from a logic circuit. <p>Conditions of low-active control signal⁷</p> <ul style="list-style-type: none"> High level input voltage: 11 V to 15 V Low level input voltage: 0 V to 4 V Low level input current: -5 mA Max. Input time requirement: 5 ms Min.
Interlock	The tester accepts an interlock input signal applied through function the SIGNAL I/O connector (14-pin Amphenol connector on the rear panel). When this signal is applied, the tester drives itself into the PROTECTION status.	
RS-232C	D-SUB 9-pin connector on the rear panel (conforms to EIA-232-D) Outputs test data and test results	
	Transmission system	Start-stop synchronization, half-duplex
	Transmission rate	9600 bps
	Data Length	8 bits
	Parity	None
	Stop bit	1 bit

⁷ SIGNAL I/O input

The signal input is isolated from the internal circuit (30 VDC/30 VACrms MAX). However, the common is shared with the signal output circuit.

The input pins are pulled up to +15 V by a resistor. Opening an input pin is equivalent to entering a high level signal.

Signal Output

Signal Name	Conditions for Signal Generation	Description
H.V ON	During the test time (period the tester delivers the test voltage)	Open-collector signal ⁸ , DANGER lamp
TEST	During the test	Open-collector signal ⁸ , Vacuum Fluorescent Display
PASS	For PASS judgment. Delivered for approximately 0.2 s.	Open-collector signal ⁸ , Vacuum Fluorescent Display, buzzer ⁹
U FAIL	For U FAIL judgment (detected current is larger than upper cutoff current)	Open-collector signal ⁸ , Vacuum Fluorescent Display, buzzer ⁹
L FAIL	For L FAIL judgment (detected current is less than lower cutoff current)	Open-collector signal ⁸ , Vacuum Fluorescent Display, buzzer ⁹
READY	When the tester is ready to execute the test	Open-collector signal ⁸ , Vacuum Fluorescent Display
PROTECTION	When the tester is in the PROTECTION status	Open-collector signal ⁸ , Vacuum Fluorescent Display
STATUS OUTPUT	When one of the DIP switches for the following items is set to ON and the corresponding status has occurred. If two or more items are set to ON, the signal is delivered on the logical sum of such items. 1: H.V ON 2: TEST 3: PASS 4: U FAIL 5: L FAIL 6: READY 7: PROTECTION 8: POWER ON	100 VAC ¹⁰ (even when the AC line voltage is other than 100 V)

⁸ The ratings of the open-collector signal are 4.5 V to 30 VDC, 400 mA (maximum, in total). The above open-collector output circuits are isolated from other internal circuits, except that the common lines of the output circuits are directly connected to those of the signal input circuits. The common lines of all open-collector circuits are connected together. The ratings are 30 VDC, 30 VACrms MAX.

⁹ Loudness of the buzzer for PASS/FAIL annunciations can be controlled with the buzzer control. It is in common for both PASS and FAIL annunciations--it does not control them separately.

¹⁰ The rating of the 100-VAC output signal is 0.3 A (maximum).

10.3 General Specifications

Item		TOS5050A	TOS5051A																																			
Environment	Spec assured temperature and humidity	5 °C to 35 °C (41 °F to 95 °F), 20 % to 80 % RH																																				
	Operable temperature and humidity	0 °C to 40 °C (32 °F to 104 °F), 20 % to 80 % RH																																				
	Storage temperature and humidity	-20 °C to 70 °C (-4 °F to 158 °F), 80 % RH or less																																				
Safety ^{11,12}		Conforms to the requirements of the following directive and standard. Low Voltage Directive 2006/95/EC EN 61010-1 Class I Pollution degree 2																																				
Electromagnetic compatibility ¹¹		Conforms to the requirements of the following directive and standard. EMC Directive 2004/108/EC EN 61326-1 EN 61000-3-2 EN 61000-3-3 Under following conditions <ol style="list-style-type: none"> 1. Used HV test leadwires TL01-TOS which is supplied. 2. No discharge occurs at outside of the tester. 3. Used the shielded cable which length is less than three meters when the SIGNAL I/O is used. 																																				
AC line power requirements	Nominal line voltage range	100 V±10 %, 50/60 Hz (Factory modification options: Normal 110 V/120 V/220 V/230 V/240 V)																																				
	Power consumption Without load (READY) <table border="0" style="width: 100%;"> <tr> <td style="width: 30%;">100 V line</td> <td style="width: 35%; text-align: center;">≤ 15 VA</td> <td style="width: 35%; text-align: center;">≤ 30 VA</td> </tr> <tr> <td>110 V line</td> <td style="text-align: center;">≤ 20 VA</td> <td style="text-align: center;">≤ 40 VA</td> </tr> <tr> <td>120 V line</td> <td style="text-align: center;">≤ 20 VA</td> <td style="text-align: center;">≤ 40 VA</td> </tr> <tr> <td>220 V line</td> <td style="text-align: center;">≤ 25 VA</td> <td style="text-align: center;">≤ 50 VA</td> </tr> <tr> <td>230 V line</td> <td style="text-align: center;">≤ 25 VA</td> <td style="text-align: center;">≤ 50 VA</td> </tr> <tr> <td>240 V line</td> <td style="text-align: center;">≤ 25 VA</td> <td style="text-align: center;">≤ 50 VA</td> </tr> </table> With rated load <table border="0" style="width: 100%;"> <tr> <td style="width: 30%;">100 V line</td> <td style="width: 35%; text-align: center;">Approx. 600 VA</td> <td style="width: 35%; text-align: center;">Approx. 630 VA</td> </tr> <tr> <td>110 V line</td> <td style="text-align: center;">Approx. 600 VA</td> <td style="text-align: center;">Approx. 630 VA</td> </tr> <tr> <td>120 V line</td> <td style="text-align: center;">Approx. 600 VA</td> <td style="text-align: center;">Approx. 630 VA</td> </tr> <tr> <td>220 V line</td> <td style="text-align: center;">Approx. 640 VA</td> <td style="text-align: center;">Approx. 640 VA</td> </tr> <tr> <td>230 V line</td> <td style="text-align: center;">Approx. 640 VA</td> <td style="text-align: center;">Approx. 640 VA</td> </tr> <tr> <td>240 V line</td> <td style="text-align: center;">Approx. 640 VA</td> <td style="text-align: center;">Approx. 640 VA</td> </tr> </table>	100 V line	≤ 15 VA	≤ 30 VA	110 V line	≤ 20 VA	≤ 40 VA	120 V line	≤ 20 VA	≤ 40 VA	220 V line	≤ 25 VA	≤ 50 VA	230 V line	≤ 25 VA	≤ 50 VA	240 V line	≤ 25 VA	≤ 50 VA	100 V line	Approx. 600 VA	Approx. 630 VA	110 V line	Approx. 600 VA	Approx. 630 VA	120 V line	Approx. 600 VA	Approx. 630 VA	220 V line	Approx. 640 VA	Approx. 640 VA	230 V line	Approx. 640 VA	Approx. 640 VA	240 V line	Approx. 640 VA	Approx. 640 VA	
100 V line	≤ 15 VA	≤ 30 VA																																				
110 V line	≤ 20 VA	≤ 40 VA																																				
120 V line	≤ 20 VA	≤ 40 VA																																				
220 V line	≤ 25 VA	≤ 50 VA																																				
230 V line	≤ 25 VA	≤ 50 VA																																				
240 V line	≤ 25 VA	≤ 50 VA																																				
100 V line	Approx. 600 VA	Approx. 630 VA																																				
110 V line	Approx. 600 VA	Approx. 630 VA																																				
120 V line	Approx. 600 VA	Approx. 630 VA																																				
220 V line	Approx. 640 VA	Approx. 640 VA																																				
230 V line	Approx. 640 VA	Approx. 640 VA																																				
240 V line	Approx. 640 VA	Approx. 640 VA																																				
Insulation resistance		≥ 30 MΩ, with 500 VDC																																				
Withstanding voltage		1390 VAC (2 seconds), between AC line and chassis																																				
Earth continuity		≤ 0.1 Ω at 25 AAC																																				

¹¹ Only on models that have CE marking on the panel. Not applicable to custom order models.

¹² This instrument is a Class I equipment. Be sure to ground the protective conductor terminal of the instrument. The safety of the instrument is not guaranteed unless the instrument is grounded properly.

Item	TOS5050A	TOS5051A
Dimensions	See Outline Drawing	
Weight ¹³	Approx. 15 kg (33.07 lb)	Approx. 16 kg (35.27 lb)

¹³ If the tester is modified to operate on an optional AC line voltage by factory modification, the weight will increase by approximately 2 kg for 100-V systems and 3 kg for 200-V systems.

Accessories

Item	Q'ty	Remarks
Power cord	1	
High voltage test leads (5 kV or less: TL01-TOS (1.5 m))	1 set	
14-pin Amphenol plug	1	Assembly type
“HIGH VOLTAGE DANGER” sticker	1	
Operation manual	1	

10.4 Outline Drawing

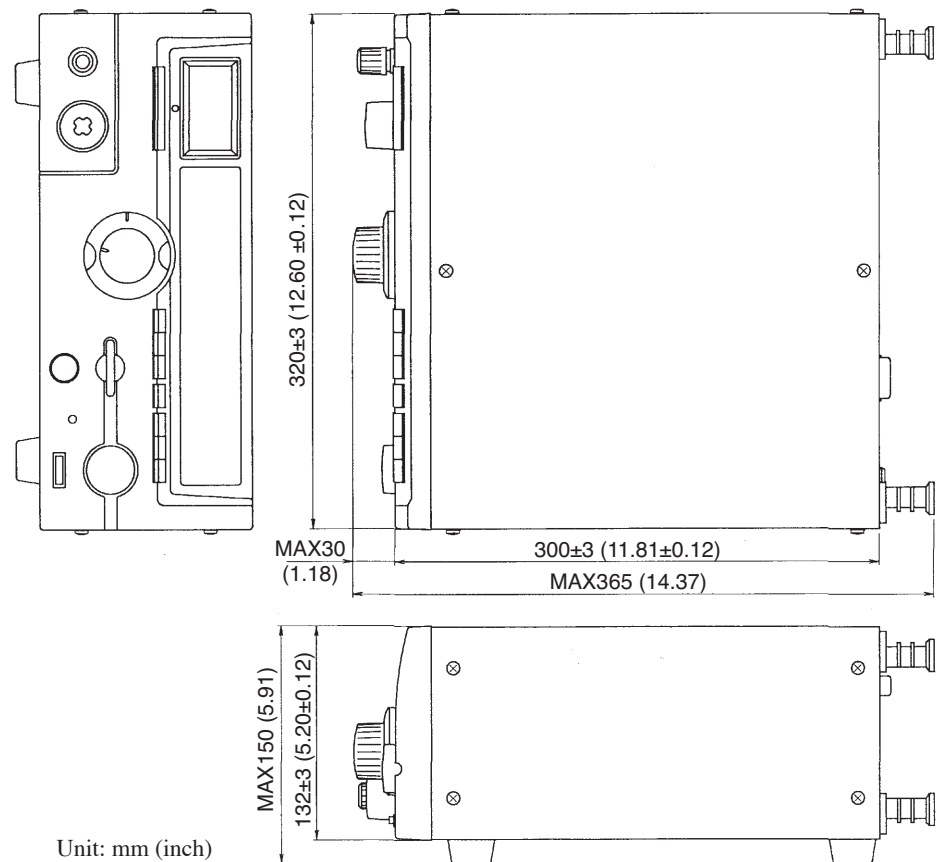

Fig.10-1 TOS5050A/TOS5051A outline drawing

Index

A

AC power supply 2-5
AC/DC test mode message 4-14
accessories 2-2
alligator clip 3-4
ammeter 4-15
analog voltmeter 4-8
analog voltmeter, zero adjustment of 4-8, 5-6

B

BUZZER 4-12

C

Class I equipment 2-6
CUTOFF CURRENT
 increment/decrement keys 4-8
 UP/LOW key 4-9

D

DANGER lamp 3-7, 4-8

E

Earth 2-6

F

factory default setup 5-2
FAIL 6-9, 6-18
FAIL messages 4-17

G

grounding 2-6

H

high test lead 3-3
HIGH VOLTAGE terminal 4-8
high voltage test probe 1-6
HP01A-TOS 1-6
HP02A-TOS 1-6

I

initial setup 5-2
input range, allowable 2-4
input voltage range 2-5
installation location 2-3
insulation gloves 3-2
interlock function 6-24

K

KEYLOCK message 4-18

L

LOW terminal 4-8
low test lead 3-2
LOWER message 4-16
LOWER ON message 4-16

M

maximum allowable continuous test period 3-8

N

nominal line voltage 2-4

O

overvoltage category II 2-5

P

PASS 6-8, 6-17
PASS message 4-17
pause time 3-8
Power cord takeups 4-20
power cord, connection of 2-5
POWER switch 4-2
PROTECTION message 4-18
protective conductor terminal 4-19

R

RC01-TOS 1-5
RC02-TOS 1-5

READY message 4-17
REMOTE connector 4-6, 6-20
remote control 6-20
remote control box 1-5
REMOTE message 4-18
RS-232C connector 4-20

S

SHIFT key 4-12
SIGNAL I/O connector 4-19, 6-21
START switch 4-4
STATUS OUT 4-20, 6-28
STOP switch 4-4

T

talk mode 7-3
test lead 3-4
TEST message 4-17
TEST MODE switches 4-20
TEST VOLTAGE control 4-7
TEST VOLTAGE RANGE message 4-13
TEST VOLTAGE switch 4-6
TIMER
 increment/decrement keys 4-10
 ON/OFF key 4-11
Timer 4-16
timer OFF 6-9, 6-18
TIMER ON message 4-17

U

UPPER message 4-16

V

vacuum fluorescent display 4-12
version number 5-4
voltmeter 4-14