

# User's Manual

Leakage Current Tester

## TOS3200

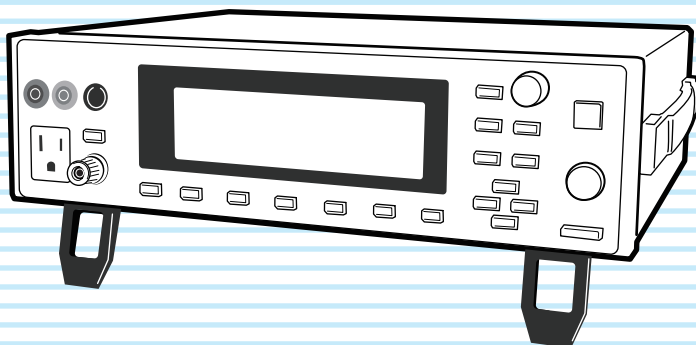

General  
Description

1

Installation and  
Preparation

2

Panel Control  
Basics

3

TC and PCC Tests

4

Meter Mode  
Measurement

5

Program Test

6

External Control

7

Maintenance

8

Specifications

9

App

## About the TOS3200 Manuals

There are five TOS5300 Series Manuals listed as follows.

- **Setup Guide**  
This manual is intended for first-time users of this product. It provides an overview of the product and notes on usage. It also explains how to set up the product for testing the DUT. Always read this manual before using the product.
- **Quick Reference**  
This manual explains Panel description and operation briefly.
- **Safety Information**  
This document contains general safety precautions for this product. Keep them in mind and make sure to observe them.
- **User's Manual (this manual)**  
This manual is intended for first-time users of this product. It provides an overview of the product and notes on usage. It also explains how to configure the product, operate the product, perform maintenance on the product, and so on.
- **Communication Interface Manual (PDF)**  
This manual contains details about remotely controlling the tester using SCPI commands. This manual is provided on the included CD-ROM.  
The interface manual is written for readers with sufficient basic knowledge of how to control measuring instruments using a PC.

TOS3200 Series Manuals are intended for users of the Leakage Current Tester and their instructors. Explanations are given under the presumption that the reader has knowledge about the electrical aspects of electrical safety testing.

## Applicable firmware version of the TOS3200

This manual applies to TOS3200s with firmware version 4.0x. When making an inquiry about the product, please provide us with the following information.

- Model (indicated at the top section on the front panel)
- Firmware version (See page 27.)
- Serial number (indicated at the bottom section on the rear panel)

## Waste Electrical and Electronic Equipment (WEEE)

### Disposing of used Kikusui products in the EU

Under a law adopted by member nations of the European Union (EU), used electric and electronic products carrying the symbol below must be disposed of separately from general household waste.



This includes the power cords and other accessories bundled with the products.

When disposing of a product subject to these regulations, please follow the guidance of your local authority, or inquire with your Kikusui distributor/agent where you purchased the product.

The symbol applies only to EU member nations.

### Disposal outside the EU

When disposing of an electric or electronic product in a country that is not an EU member, please contact your local authority and ask for the correct method of disposal.

## Trademarks

Company names and product names used in this manual are generally trademarks or registered trademarks of the respective companies.

## Copyright

Reproduction and reprinting of this operation manual, whole or partially, without our permission is prohibited.

Both unit specifications and manual contents are subject to change without notice.

© 2007 Kikusui Electronics Corporation

## Safety Symbols

For the safe use and safe maintenance of this product, the following symbols are used throughout this manual and on the product. Note the meaning of each of the symbols to ensure safe use of the product. (Not all symbols may be used.)

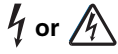

Indicates that a high voltage (over 1000 V) is used here. Touching the part causes a possibly fatal electric shock. If physical contact is required by your work, start work only after you make sure that no voltage is output here.

### **DANGER**

Indicates an imminently hazardous situation which, if ignored, will result in death or serious injury.



Indicates a potentially hazardous situation which, if ignored, could result in death or serious injury.



Indicates a potentially hazardous situation which, if ignored, may result in damage to the product and other property.



Shows that the act indicated is prohibited.



Indicates a general danger, warning, or caution. When this symbol is marked on the product, see the relevant sections in this manual.



Protective conductor terminal.



Chassis (frame) terminal.



On (supply)



Off (supply)



In position of a bi-stable push control



Out position of a bi-stable push control

## Notations Used in This Manual

- The TOS3200 Leakage Current Tester is also simply referred to as the TOS3200 in this manual.
- Equipment under test is also referred to as the EUT in this manual.
- The word "PC" used in this manual is a generic term for personal computers and workstations.
- Touch current is simply referred to as TC in this manual.
- Protective conductor current is simply referred to as PCC in this manual.
- The following markings are used in this manual.

### **WARNING**

Indicates a potentially hazardous situation which, if ignored, could result in death or serious injury.

### **CAUTION**

Indicates a potentially hazardous situation which, if ignored, may result in damage to the product and other property.

### **NOTE**

Indicates information that you should know.

### **DESCRIPTION**

Explanation of terminology or operation principle.

### **See**

Indicates reference to detailed information.

>

Indicates the menu level of the item to be selected. The menu item to the left of the > symbol is a higher level menu.

### **SHIFT+key name (marked in blue)**

Indicates an operation involving pressing the named key (shown in blue) while the SHIFT key is held down.

### **SHIFT+Fx (F1 to F5)**

Indicates an operation involving pressing a function key (F1 to F5) while the SHIFT key is held down.

## Safety Precautions

The following safety precautions must be observed to avoid fire hazards, electric shock, accidents, and other failures. Keep them in mind and make sure to observe them.

Using the product in a manner that is not specified in this manual may impair the protection functions provided by the product.



### Users

- This product must be used only by qualified personnel who understand the contents of this operation manual.
- If an unqualified personnel is to use the product, be sure the product is handled under the supervision of qualified personnel (those who have electrical knowledge). This is to prevent the possibility of personal injury.



### Purpose of use

- Never use the product for purposes other than the product's intended use.
- This product is not designed or manufactured for general home or consumer use.

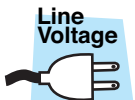

### Input power

- Use the product within the rated input power voltage range.
- For applying power, use the power cable provided. For details, see the respective page in the operation manual.
- This product is an equipment of IEC Overvoltage Category II (energy-consuming equipment supplied from the fixed installation).



### Fuse

- The fuse can be replaced on this product. When replacing the fuse, use a fuse of shape, rating, and characteristics that conform to the product. For details, see the respective page in the operation manual.



### Cover

- Some parts inside the product may cause physical hazards. Do not remove the external cover.



### Grounding

- This product is an IEC Safety Class I equipment (equipment with a protective conductor terminal). To prevent electric

shock, be sure to connect the protective conductor terminal of the product to electrical ground (safety ground).

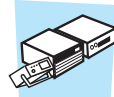

### Installation

- This product is designed for safe indoor use. Be sure to use the product indoors.
- When installing products, be sure to observe precautions concerning installation location. For details, see the respective page in the operation manual.



### Relocation

- Turn off the POWER switch, and disconnect the cables before relocating the product.
- When relocating the product, be sure to include the manual.



### Operation

- If a malfunction or abnormality is detected on the product, stop using it immediately, and remove the power cord plug from the outlet. Make sure the product is not used until it is completely repaired.
- Do not disassemble or modify the product. If you need to modify the product, contact your Kikusui distributor/agent.



### Maintenance and inspection

- To prevent electric shock, be sure to unplug the product before carrying out maintenance or inspection. Do not remove the external cover.
- Check periodically that there are no tears or breaks in the power cord and the test lead covering.
- If the panel needs cleaning, gently wipe using a soft cloth with water-diluted neutral detergent. Do not use volatile chemicals such as benzene or thinner.
- To maintain the performance and safe operation of the product, it is recommended that periodic maintenance, inspection, cleaning, and calibration be performed.



### Service

- Kikusui service engineers will perform internal service on the product. If the product needs adjustment or repairs, contact your Kikusui distributor/agent.

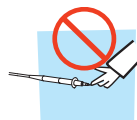

### Test leads

- To avoid electric shock, do not touch the tip of a test lead while testing (during the touch current measurement).

## DANGER lamp

- The DANGER lamp illuminates while the test is in progress. If the DANGER lamp is illuminated, the voltage applied to AC LINE IN (EUT) is output to the AC LINE OUT terminal.

## Measurement category

- Measurement terminals A and B comply with IEC Standard Measurement Category II. Measurement Category II (CAT II) is used to measure the primary circuit of equipment (household electric appliances, portable tools, etc.) that is connected directly to a low-voltage installation such as an outlet.

## Ground terminal

- In case of measuring the touch current in the condition of “Earth line disconnected status” of the EUT, a hazardous voltage may apply to the ground terminal. Do not touch the ground terminal while the test is in progress.

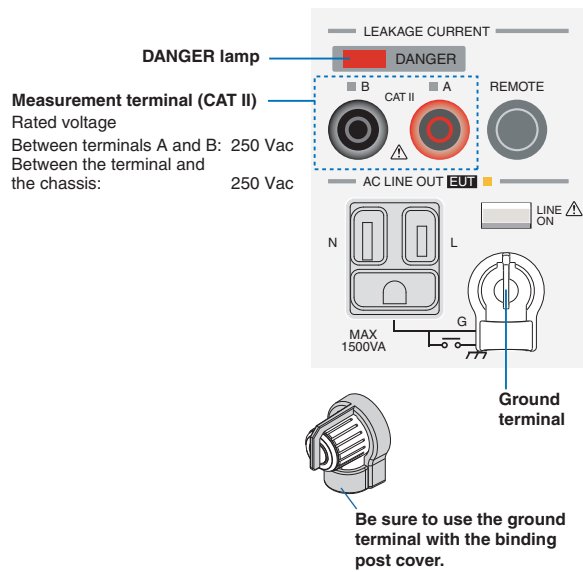

# Contents

About the TOS3200 Manuals .....	2
Safety Symbols .....	3
Notations Used in This Manual .....	3
Safety Precautions .....	4
Contents .....	6
Contents by Objectives .....	10
Front panel .....	12
Rear panel.....	14

## 1 General Description

Product Overview.....	16
Features.....	16
Options.....	18
Rack Mounting Option .....	18
Test Probe .....	18
Multi Outlet.....	19

## 2 Installation and Preparation

Checking the Package Contents.....	22
Precautions Concerning Installation Location.....	23
Using the Stand .....	24
Precautions for Moving the Product.....	24
Connecting the Power Cord.....	25
Connecting the Power Cord for the TOS3200 .....	26
Connecting the Power Cord for the EUT.....	26
Turning the Power On.....	27
Turning the POWER Switch On.....	27
Turning the POWER Switch Off.....	28

## 3 Panel Control Basics

Screen Configuration .....	30
Panel Control .....	32
Switching the Screen .....	32
Selecting Items .....	32
Entering Data .....	33
Adjusting the Screen Brightness.....	34
Key Lock .....	34
Selecting the Operation Mode.....	35
Single Tests (TC/PCC/METER).....	35
Program Tests (AUTO).....	35
Panel Memory.....	36
Storing to the Test Conditions.....	37
Recalling from the Test Conditions .....	37

# 4

## TC and PCC Tests

Connecting the EUT .....	40
Using the Output on the Front Panel .....	40
Using the Terminal Block on the Rear Panel .....	40
Using the Optional Multi Outlet (OT01-TOS).....	41
Checking the EUT Operation .....	42
Connecting the Test lead (TL21-TOS) .....	43
Using the Flat Probe (FP01-TOS) .....	46
Using the Optional Test Probe (HP21-TOS) .....	47
Measurement Check .....	47
Judgment System.....	48
Validity of the Lower Reference .....	48
Test Wait Time and Judgment .....	49
Setting Test Conditions of the TC Measurement .....	50
Setup Items of TC1/2 (PROBE / POL / COND) .....	50
Setup Items of TC1/2 (LOWER / UPPER / TIMER / WAIT) .....	52
Setup Items of TC2/2 (NTWK / MODE / RANGE).....	53
Setting Test Conditions of the PCC Measurement.....	54
Setup Items of PCC1/2 (POL / COND) .....	54
Setup Items of PCC1/2 (LOWER / UPPER / TIMER / WAIT) .....	56
Setup Items of PCC2/2 (MODE / RANGE).....	57
Setting Additional Test Conditions .....	58
Maximum Value Hold Function of the Measured Current (MEAS MODE) .....	58
Hold Time of the PASS Judgment (PASS HOLD).....	58
Measured Current Conversion Display (CONV).....	59
Buzzer Volume (BUZ VOL) .....	59
Starting the Test.....	60
Starting the Test .....	60
When the Test Starts.....	60
Switching to Expanded Display .....	62
Displaying the Voltage between the Measurement Network Reference Points ..	62
Unable to Start the Test .....	63
Stopping the Test .....	64
Aborting the Test .....	64
When the Test Ends.....	64
Storing the Test Result.....	64
Releasing the Judgment Result .....	64
Storing the Test Results .....	65
Displaying the Test Results.....	66
Deleting the Stored Data .....	66

# 5

## Meter Mode Measurement

Connecting the EUT .....	68
Constructing the Connection Circuit.....	68
Connecting the Test lead (TL21-TOS) .....	69
Measuring in Meter Mode.....	70
Maximum Value Hold Function of the Measured Current (MEAS MODE) .....	70
SELV Detection Function .....	71
Setup Items of METER2/2 (NTWK / MODE / RANGE) .....	71

# 6 Program Test

Program Tests.....	74
Limitations on the Test Conditions in the Steps.....	75
Interval Time .....	75
Creating Sequence Programs.....	76
Inserting a Step in a New Program .....	76
Inserting a Step in an Existing Program.....	77
Deleting a Step .....	77
Setup Items of AUTO1/2.....	78
Setup Items of AUTO2/2 (Common to All Steps).....	80
Sequence Program Editing Procedure.....	81
Entering the Edit Screen .....	81
Setting Items Common to the Program (All Steps) .....	82
Setting Step 00 .....	82
Setting Step 01 .....	83
Exiting from the Edit Screen .....	83
Setting Additional Test Conditions .....	84
Maximum Value Hold Function of the Measured Current (MEAS MODE).....	84
Hold Time of the PASS Judgment (PASS HOLD) .....	84
Measured Current Conversion Display (CONV) .....	85
Buzzer Volume (BUZ VOL).....	85
Power supply to the EUT during the interval time (LINE BRK (AUTO)).....	86
Starting the Test.....	86
Starting the test.....	86
When a test starts .....	86
Unable to Start the Test .....	88
Stopping the Test.....	89
Aborting the Test.....	89
When the Test Ends .....	89
Program Test Judgment .....	89
Storing the Test Result .....	90
Releasing the Judgment Result .....	90
Storing the Test Results.....	91
Displaying the Test Results.....	92
Deleting the Stored Data.....	92

# 7 External Control

SIGNAL I/O Connector.....	94
SIGNAL I/O Specifications .....	94
Internal Construction .....	96
Application Examples of Input Signal.....	96
Application Examples of Output Signal .....	97
Starting the Test.....	97
Recalling the Panel Memory and Sequence Program .....	98

# 8 Maintenance

Test Lead Check.....	100
Measurement Check.....	100
Time Settings and Calibration Management.....	102
Calibration .....	103
Replacing the Fuse .....	104
Replacing the Backup Battery.....	104



# 9

## Specifications

Measurement Items, Measurement Mode, and Measurement Network .....	106
Current Measurement Section*1 .....	106
Judgment Function .....	108
Voltage Measurement Between A and B .....	109
Timer, Test Function, and Memory .....	109
Other Functions .....	110
Interface .....	111
General .....	112
Outline Drawing .....	113
Measurement Network (NTWK) .....	114

## Appendix

A A List of Default Settings .....	116
Initializing the TOS3200 .....	116
Default Values of the Panel Memory .....	118
B System Settings .....	120
Setup Items of SYSTEM1/5 .....	120
Setup Items of SYSTEM2/5 .....	121
Setup Items of SYSTEM3/5 .....	122
Setup Items of SYSTEM4/5 .....	122
Setup Items of SYSTEM5/5 .....	123
C Protection Function .....	124
D Troubleshooting .....	125
INDEX .....	127

# Contents by Objectives

## Preparation

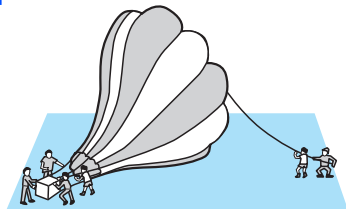

---

• <b>What accessories are included?</b>	
→“Checking the Package Contents”	22

---

• <b>The EUT power cord cannot be connected to the front panel outlet. What is the workaround?</b>	
→“Using the Terminal Block on the Rear Panel”	40

---

• <b>How do I check the operation of the EUT before testing?</b>	
→“Checking the EUT Operation”	42

---

• <b>How do I measure the TC (when touching with my palm)?</b>	
→“Using the Flat Probe (FP01-TOS)”	46

---

• <b>How do I use the two test leads?</b>	
→“Connecting the Test lead (TL21-TOS)”	43

---

• <b>How do I check that correct measurements can be made during the preliminary inspection?</b>	
→“Measurement Check”	100

## Setting

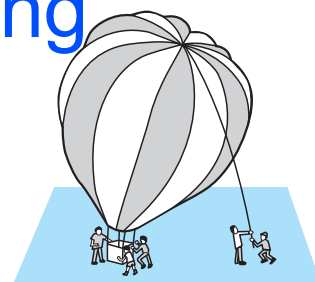

---

• <b>How do I measure the TC?</b>	
→“Setting Test Conditions of the TC Measurement”	50

---

• <b>How do I measure the PCC?</b>	
→“Setting Test Conditions of the PCC Measurement”	54

---

• <b>How do I measure the TC using the external circuit for that I was using until now?</b>	
→“Meter Mode Measurement”	67

---

• <b>How are the measured values are judged?</b>	
→“Judgment System”	48

---

• <b>How do I stop measurements while the EUT is starting up?</b>	
→“Test Wait Time and Judgment”	49

---

• <b>What is the maximum value during the measurement?</b>	
→“Maximum Value Hold Function of the Measured Current (MEAS MODE)”	58

---

• <b>What is the measured value at the voltage that is higher (or lower) than the actual power voltage supplied to the EUT.</b>	
→“Measured Current Conversion Display (CONV)”	59

---

• <b>How do I find when the TOS3200 was calibrated the last time?</b>	
→“Time Settings and Calibration Management”	102

# Operation

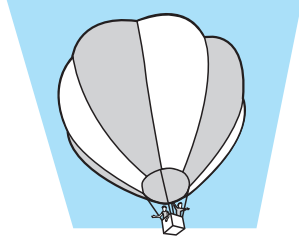

- **How do I save the test results?**  
→“Storing the Test Results” 65

---

- **How do I save the present test conditions and use them later?**  
→“Panel Memory” 36

---

- **How do I measure the voltage between measurement terminals A and B?**  
→“Displaying the Voltage between the Measurement Network Reference Points” 62  
→“Measuring in Meter Mode” 70

---

- **How do I prevent the test conditions from being changed inadvertently?**  
→“Key Lock” 34

---

- **How do I perform consecutive tests by changing the test conditions for each test?**  
→“Program Tests” 74

---

- **How do I apply an external signal to control the TOS3200?**  
→“SIGNAL I/O Connector” 94

---

- **How do I record the start and end of the test on the printer?**  
→“Talk mode” \*1

\*1 See the Communication Interface Manual.

# Maintenance

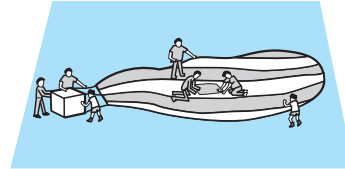

- **How do I check whether the test leads are conducting signals correctly?**  
→“Measurement Check” 100

---

- **How do I change the calibration due date?**  
→“Time Settings and Calibration Management” 102

---

- **How do I synchronize the system clock?**  
→“Time Settings and Calibration Management” 102

---

- **How do I replace the fuse?**  
→“Replacing the Fuse” 104

## Troubleshooting

See “Troubleshooting” on page 125.

# Front panel

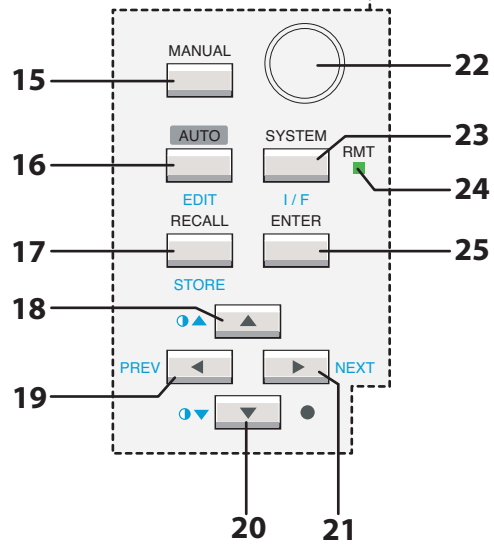
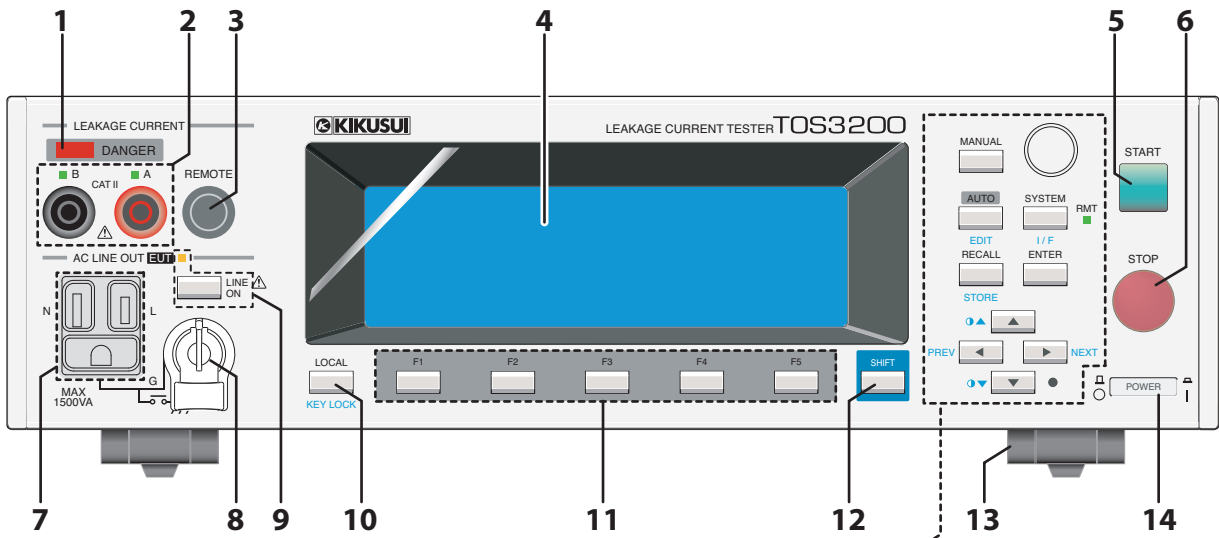

No.	Name	Function	See Page
1	DANGER lamp	Illuminates while a test is in progress.	5, 60
2	A/B terminal	Measurement terminal. Connect the test lead or probe to this terminal. If this terminal is required depending on the test mode, the LED above the terminal will illuminate.	5, 44
3	REMOTE connector	A dedicated connector used to connect the HP21-TOS option probe.	47
4	Display	Displays various types of information such as settings and measured values.	30
5	START switch	Starts the test.	60
6	STOP switch	Stops the test.	64
7	AC LINE OUT EUT	Supplies the power applied to the AC inlet for the EUT.	40
8	Ground terminal	Connect the ground wire when connecting a two-prong cord with a ground wire to AC LINE OUT.	5, 40
9	LINE ON key	Turns the output of AC LINE OUT. The LED above the key illuminates while the output is on.	42
10	LOCAL key	Switches between the remote and local modes.	*1
	KEY LOCK key	Disables only the operations that change the settings.	34
11	F1 ~ F5 key	Function keys corresponding to the menu that appears on the screen.	31
12	SHIFT key	Calls up the functions marked in blue characters.	—
13	Leg and stand	Allows you to lift up the front panel side of the unit.	24
14	POWER switch	Turn the power on (I) or off (O).	27
15	MANUAL key	Selects the operation mode.	35
16	AUTO key	Selects the program test.	74
	EDIT key	Edits the test conditions of the program test.	
17	RECALL key	Recalls settings from the panel memory.	36
	STORE key	Stores the settings to the panel memory.	
18	▲ key	Moves the cursor up.	32
	●▲ key	Increases the screen brightness.	34
19	◀ key	Moves the cursor to the left.	32
	PREV key	Returns to the previous screen.	
20	▼ key	Moves the cursor down.	32
	●▼ key	Decreases the screen brightness.	34
21	▶ key	Moves the cursor to the right.	32
	NEXT key	Moves to the next screen.	
22	Rotary knob	Changes the settings.	33
23	SYSTEM key	Displays the system settings.	120
	I/F key	Displays the interface settings.	*1
24	RMT LED	Illuminates when the TOS3200 is operating in remote control mode.	*1
25	ENTER key	Confirms the panel memory to be recalled.	36

\*1 See the Communication Interface Manual.

## Rear panel

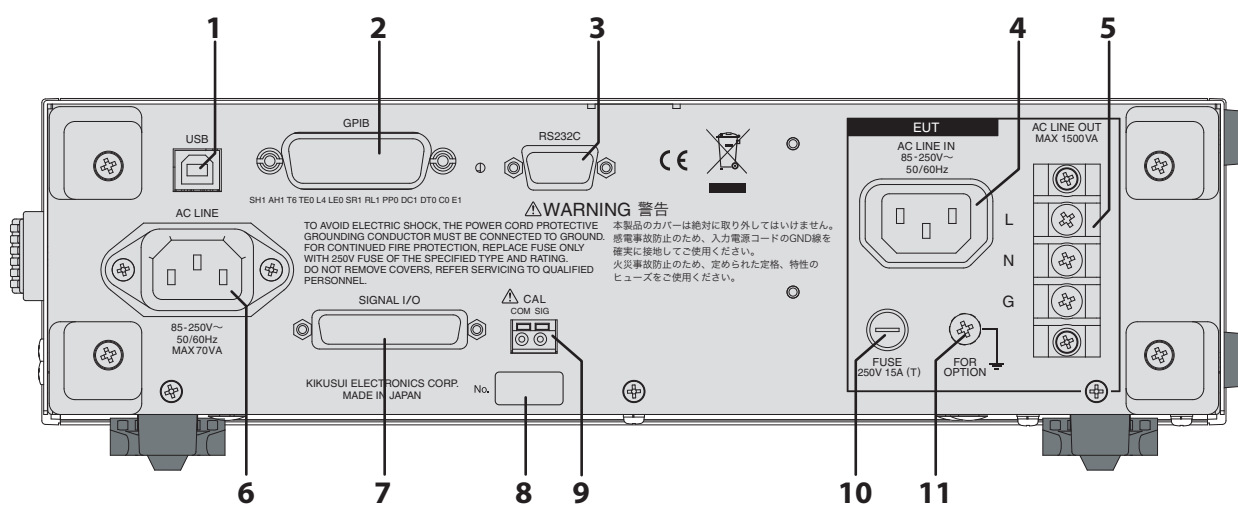

No.	Name	Function	See Page
1	USB connector	USB interface.	*1
2	GPIB connector	GPIB interface.	*1
3	RS232C connector	RS232C interface.	*1
4	AC LINE IN	AC inlet for the EUT.	25
5	AC LINE OUT	Supplies the power applied to the AC inlet for the EUT.	40
6	AC LINE	AC inlet for the TOS3200.	25
7	SIGNAL I/O connector	External control signal connector.	94
8	Serial number	The serial number of the TOS3200.	—
9	CAL terminal	A terminal only used for calibration. Do not connect anything to this terminal.	—
10	FUSE	Input power fuse for the EUT.	104
11	FOR OPTION terminal	Connect the GND wire of the OT01-TOS Multi Outlet.	41

\*1 See the Communication Interface Manual.



# 1

---

## General Description

This chapter gives an overview and describes the features.

# Product Overview

The TOS3200 Leakage Current Tester is used to measure the leakage current of the four tests<sup>\*1</sup> that are required to secure the safety of electric equipment. The tester covers general electric and electronic equipment excluding medical equipment. Various measurement networks and wide-bandwidth measurement circuits are built in allowing the execution of tests meeting the requirements of safety standards such as IEC, EN, UL, VDE, and JIS as well as Electrical Appliance and Material Safety Law. Because the TOS3200 is equipped with an outlet and terminal block for supplying power, connecting the power line of the EUT is easy.

## Features

### ● Measurement of TC and PCC conforming to IEC 60990<sup>\*2</sup>

The TOS3200 is capable of measuring the TC using a measurement network (perception, reaction, let-go, and electric burn based on IEC 60990). In addition, the PCC can be measured simply by connecting the EUT to the TOS3200.

The internal voltmeter can measure the DC, true rms, and peak values and supports a measurement frequency up to 1 MHz for AC measurement, satisfying the recommended items of the standard.

### ● Equipped with eight measurement networks as standard (circuit networks representing the human body impedance)

The TOS3200 is equipped with eight measurement networks as standard including that of IEC 60990 allowing the measurement of the TC on most general electric and electronic equipment.<sup>\*3</sup>

### ● Fault simulation of the power line supplied to the EUT

The TOS3200 supplies power not only to the EUT, but also allows you to carry out fault simulation easily as required by the standard such as protective grounding disconnection, power line disconnection, and polarity inversion.

### ● Program test that allows tests to be executed in sequence

Tests containing up to 100 steps can be executed consecutively by arbitrarily combining the TC and PCC measurements.

### ● Meter Measurement Mode with a voltmeter having the TC measurement and SELV detection functions

The TOS3200 is equipped with a meter measurement mode that separates the power line control and specializes in the measurement functions. It can be used in a similar manner as conventional analog leakage ammeter.

In Meter Measurement Mode, the voltage between measurement terminals can be measured in addition to the TC measurement. The TOS3200 is also equipped with a SELV detection function that warns using a DANGER lamp if the preset SELV voltage is exceeded. For example, this feature is convenient if you want to check whether the voltage is exceeding the safety extra low voltage (SELV); measure the TC to check whether the circuit is a limited current circuit; and use these results to judge whether the circuit is a hazardous live.

### ● CONV function that converts the measured value to a current at the desired supply voltage

Judgment can be performed by converting the measured power line voltage and the TC or PCC to the TC or PCC of a preset power line voltage.



- **CAL ALARM function that warns the expiration of the calibration period**

A warning message will be generated when a preset calibration period passes. It is also possible to limit the use of the TOS3200 by activating the protection status when the period elapses.

- **Function for holding the maximum value during the measurement**

The maximum TC or PCC during the measurement can be held. The maximum value can be measured even if the current fluctuates during the measurement.

- **Function for setting a wait time until the test is actually executed after starting the power supply**

You can set a wait time for the test (time until the test is actually executed after starting the power supply to the EUT). This feature is useful if you want to measure the current after the EUT reaches the steady state avoiding the transient state of the EUT immediately after turning the power on.

- **Window comparator function that sets the upper and lower limits of judgement**

You can set not only the upper reference of the TC or PCC but also the lower reference. This feature helps to discover breaks in test leads and mistakes in the setup/procedure and allows highly reliable tests.

- **Stores up to 100 test conditions**

The test conditions of up to 100 individual tests (TC or PCC measurement) can be saved with a name.\*<sup>5</sup> Up to 100 sequence programs for program tests can also be saved with a name.\*<sup>4</sup>

The number of the safety standard on which the test is based and the EUT model can be used as a name for the test conditions.

- **Stores the data for up to 50 test results**

The test result, the date/time of the test, and the test conditions can be stored. Up to 50 results can be stored separately for individual tests and program tests.

- **Equipped with RS-232C, USB, and GPIB as standard**

The TOS3200 is equipped with RS-232C, USB, and GPIB as standard. You can control test conditions and read the measured values and test results through a PC or a sequencer.

\*1 Withstanding Voltage Test, Insulation Resistance Test, Earth Continuity Test, and Leakage Current Test

\*2 IEC 60990: Methods of measuring TC and PCC

The current that is referred to as the "leakage current" is divided into TC (current that flows when a human being touches the electric equipment) and PCC (current that flows through the protective conductor of a Class I equipment).

\*3 Medical equipment is not supported.

\*4 Among the 100 presets, test conditions of TC conforming to the safety standards are stored to presets 00 to 50 in advance. These presets can be recalled and used in the TC test.

\*5 Up to 100 steps in a program and up to 500 steps total in all programs.

# Options

The following options are available for the TOS3200.  
For details on the options, contact your Kikusui agent or distributor.

## Rack Mounting Option

Item	Model	Notes
Rack mount adapter	KRA3-TOS	Inch rack EIA standard
	KRA150-TOS	Milli rack JIS standard

This option allows the terminal block for the EUT on the rear panel to be used from the front panel making it easy to connect the EUT even after the TOS3200 is rack mounted.

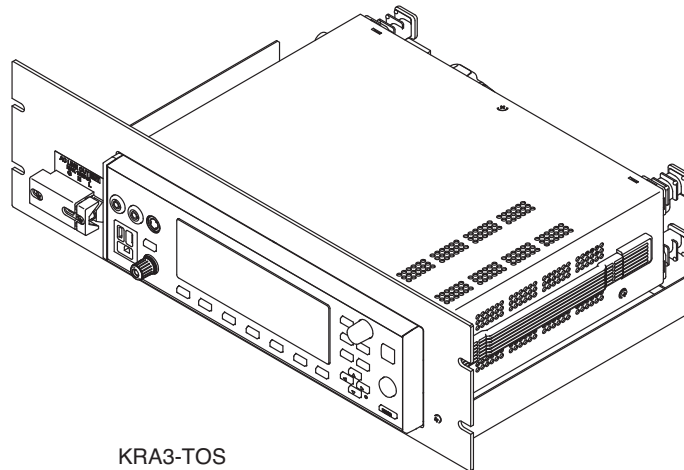

KRA3-TOS

## Test Probe

See p. 47

A test probe can be used in place of the test lead in the TC measurement. It provides fingertip control to start the test.

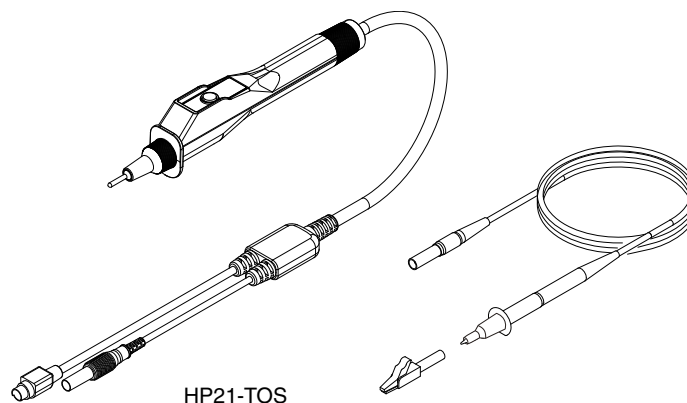

HP21-TOS

## Multi Outlet

See p. 41

This option expands the outlet on the front panel. It allows popular plugs around the world to be connected.

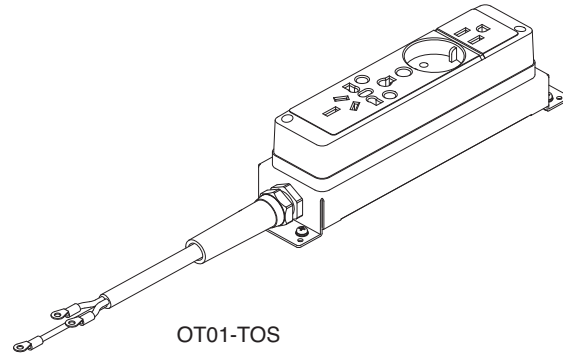

This page has been intentionally left blank.





# 2

---

## Installation and Preparation

This chapter describes the procedures of unpacking and preparation of the TOS3200 before use.

# Checking the Package Contents

When you receive the product, check that all accessories are included and that the accessories have not been damaged during transportation.

If any of the accessories are damaged or missing, contact your Kikusui agent or distributor.

We recommend that you keep all packing materials, in case the product needs to be transported at a later date.

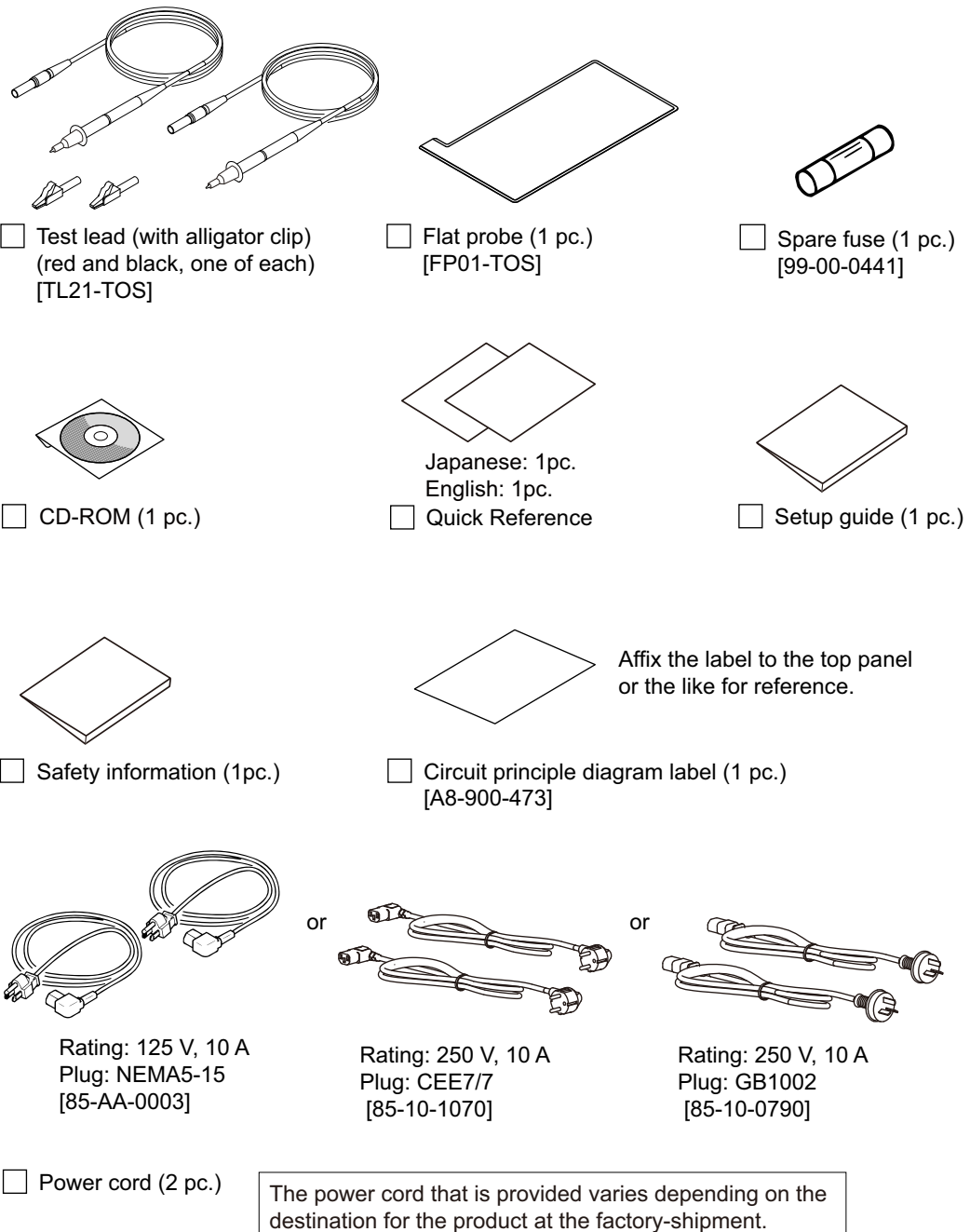

Fig. 2-1 Accessories

# Precautions Concerning Installation Location

Be sure to observe the following precautions when installing the product.

● **Do not use the product in a flammable atmosphere.**

To prevent explosion or fire, do not use the product near alcohol, thinner or other combustible materials, or in an atmosphere containing such vapors.

● **Avoid locations where the product is exposed to high temperature or direct sunlight.**

Do not install the product near a heater or in areas subject to drastic temperature changes.

Operating temperature range: 0 °C to +40 °C (+32 °F to +104 °F)

Storage temperature range: -20 °C to +70 °C (-4 °F to +158 °F)

● **Avoid humid environments.**

Do not install the product in high-humidity locations near a boiler, humidifier, or water supply.

Operating humidity range: 20 %rh to 80 %rh (no condensation)

Storage humidity range: 0 to 90 %rh (no condensation)

Condensation may occur even within the operating humidity range. If this happens, do not use the product until the condensation dries up completely.

● **Be sure to use the product indoors.**

This product is designed for safe indoor use.

● **Do not install the product in a corrosive atmosphere.**

Do not install the product in a corrosive atmosphere or in environments containing sulfuric acid mist, etc. This may cause corrosion of various conductors and bad contacts of connectors inside the product leading to malfunction and failure, or in the worst case, a fire.

● **Do not install the product in a dusty location.**

Accumulation of dust may lead to electric shock or fire.

● **Do not use the product where ventilation is poor.**

Secure adequate space around the product so that air can circulate around it.

● **Do not place objects on the product.**

Placing heavy objects on top of the product may cause failures.

● **Do not install the product on an inclined surface or location subject to vibrations.**

The product may fall or tip over causing damages and injuries.

● **Do not use the product in a location where strong magnetic or electric fields are nearby or a location where large amount of distortion and noise is present on the input power supply waveform.**

The product may malfunction.

● **Use the product in an industrial environment.**

This product may cause interference if used in residential areas. Such use must be avoided unless the user takes special measures to reduce electromagnetic emissions to prevent interference to the reception of radio and television broadcasts.

## Using the Stand

The stand is used to tilt the front panel for easier viewing of the screen and improving the operability of the keys.

Pull and flip over the stand underneath at the front until it clicks in place.

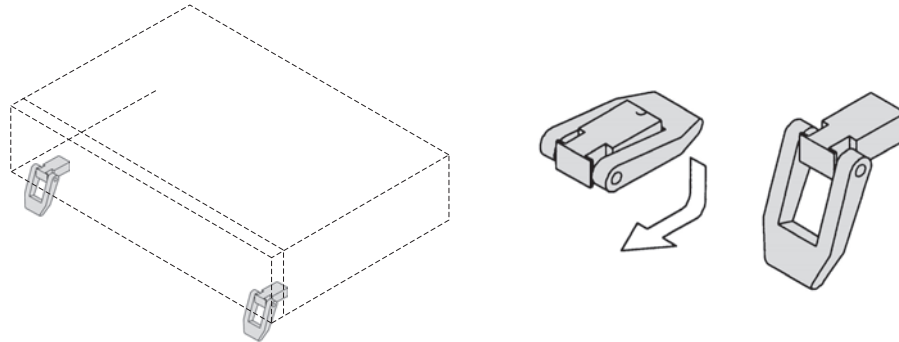

Fig. 2-2 Using the stand



**CAUTION** When using the stand, do not place objects on top of the product or apply downward force from the top of the product. To do so may cause the stand to break.

## Precautions for Moving the Product

Note the following points when moving or transporting the product to the installation location.

- **Turn off the POWER switch.**  
Moving the product with the power is turned on may cause electric shock or damage to it.
- **Disconnect all wiring.**  
Moving the product with the cables connected may cause wires to break or injuries due to the product falling over.
- **When transporting the product, be sure to use the original packing materials.**  
Otherwise, damage may result from vibrations or from the product falling during transportation.
- **Be sure to include this manual.**



# Connecting the Power Cord



- This product is an IEC Safety Class I equipment (equipment with a protective conductor terminal). To prevent electric shock, be sure to ground (earth) the unit.
- This product is grounded through the ground wire of the power cord. Be sure to connect the power plug to an outlet with an appropriate earth ground.



- Use the supplied power cord to connect to the AC line.  
If the supplied power cord cannot be used due to the rated voltage or the plug shape, have the cord replaced with an appropriate power cord of length 3 m or less by a qualified engineer. If obtaining a power cord is difficult, consult your Kikusui agent or distributor.
- In an emergency, the power cord with a plug may be used to disconnect the product from the AC line in an emergency. Connect the plug to an easily accessible power outlet so that the plug can be removed from the outlet at any time. Be sure to allow enough space around the power outlet.
- Do not use the supplied power cord on other instruments.

This product is an equipment of IEC Overvoltage Category II (energy-consuming equipment supplied from the fixed installation).

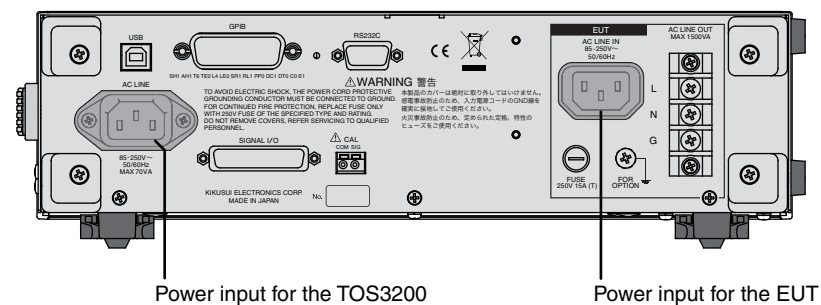

Fig. 2-3 AC inlet

## Connecting the Power Cord for the TOS3200

- 1** Turn the **POWER** switch off.
- 2** Check that the **AC** power line complies with the input rating of the **TOS3200**.  
The voltage that can be applied is any of the nominal power supply voltages in the range of 100 Vac to 240 Vac. The frequency is 50 Hz or 60 Hz.
- 3** Connect the power cord to the **AC inlet (AC LINE)** on the rear panel, and connect the power cord plug to an outlet with proper grounding.

## Connecting the Power Cord for the EUT



The rated current of the supplied power cord is 10 A. To prevent fire, replace the power cord with an appropriate one if the input current to the EUT exceeds 10 A.



If you are using the TOS3200 in Meter Mode, you do not have to connect the power cord for the EUT.

The power to the EUT is supplied through the TOS3200. The input rating of the EUT must meet the input rating of the power input to the EUT of the TOS3200.

- Input voltage range: 85 V to 250 V
- Frequency: 50 Hz or 60 Hz
- Maximum power: 1500 VA

- 1** Check that the **AC** power line to be connected complies with the input rating of the power input for the EUT above.
- 2** Connect the power cord to the **AC inlet (AC LINE IN)** on the rear panel, and connect the power cord plug to an outlet with proper grounding.

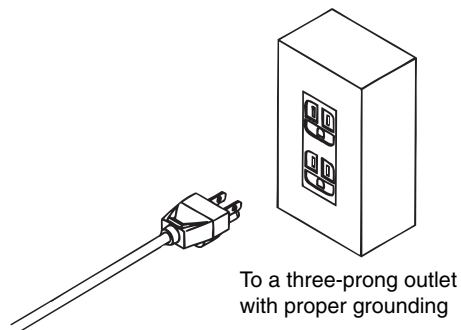
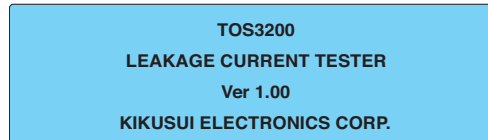

Fig. 2-4 Plug connection

# Turning the Power On

## Turning the POWER Switch On

- 1 Press the POWER switch to turn the power on (|).
- 2 Check the firmware version (Ver x.xx) that appears on the screen.



See p. 116

When you turn the POWER switch on for the first time, the TC measurement screen (TC1/2) will appear after the firmware version (factory default setting).

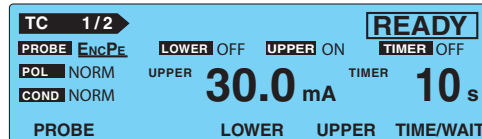

Because the TOS3200 stores the conditions immediately before the POWER switch is turned off, the TOS3200 starts up using the conditions that existed when the POWER switch was turned off the last time.

### System clock

The TOS3200 manages the calibration date using the internal system clock. If the preset calibration period is due when the power is turned on, the message "CAL DATE EXPIRED" will appear on the screen.



See p. 102

For the procedure to set the system clock and the remedy when the calibration period expires, see "Time Settings and Calibration Management."

## Turning the POWER Switch Off

---



**CAUTION** To prevent damage to the EUT, be sure to turn off the power switch of the EUT first and then the power switch of the TOS3200 if the power cord of the EUT is connected to the TOS3200.

---

**Press the POWER switch to turn the power off (O).**

The TOS3200 stores the panel settings immediately before the POWER switch is turned off. If the POWER switch is turned off immediately after changing the settings, the last settings may not be stored.



# 3

---

## Panel Control Basics

This chapter explains how to select items on the screen and how to enter values.

# Screen Configuration

The screen consists of the following four areas.

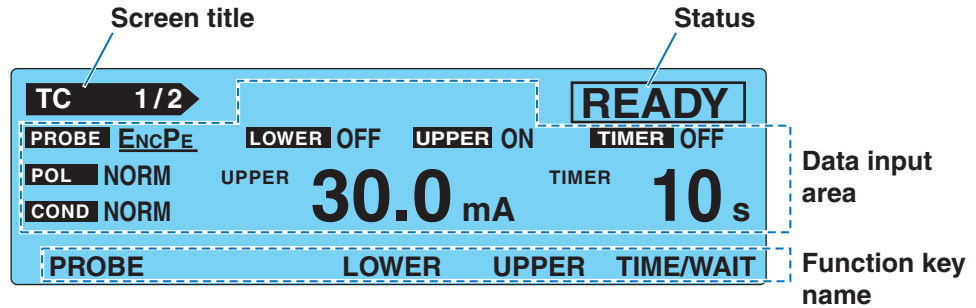

See p. 116

The screen above is the initial screen (factory default settings) that appears when you turn the POWER switch for the first time. To reset the TOS3200 to factory default settings, turn on the POWER switch while holding down the SHIFT key.

## Screen title

Indicates the screen that is currently displayed.

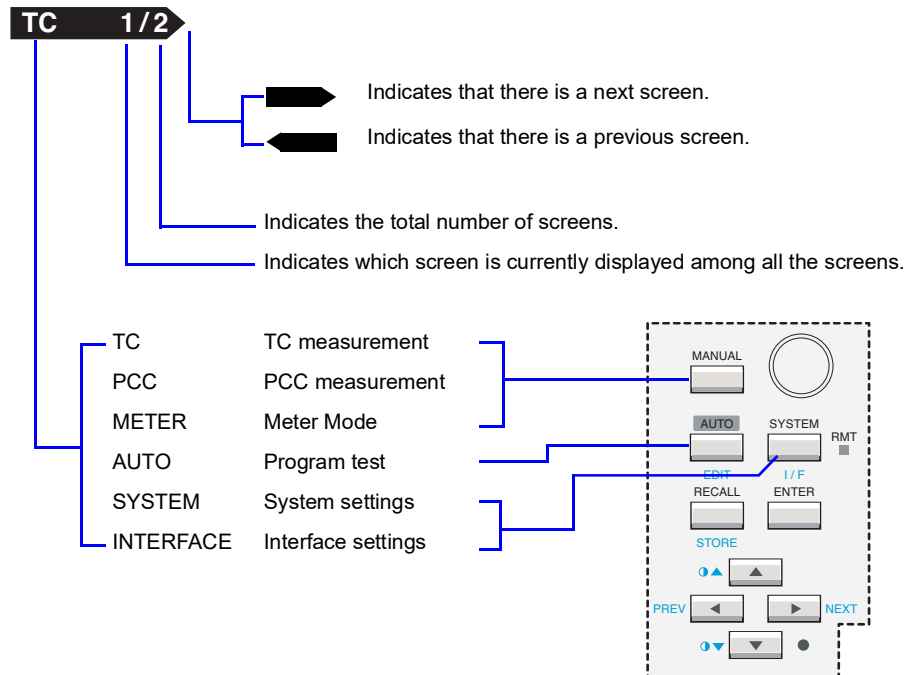

### Status

Indicates the present status of the TOS3200.

READY	Indicates that the TOS3200 is ready to start the test.
WAIT	Indicates that the TOS3200 is waiting for the test.
TEST	Indicates that the test is in progress.
PASS	Indicates that the measured current was within the reference range.
↑FAIL	Indicates that a current greater than or equal to the upper reference was measured.
↓FAIL	Indicates that a current less than or equal to the lower reference was measured.
↕FAIL	Indicates that the enclosure is grounded in the earthing check.*1
EDIT	Indicates that the sequence program is being edited.
PROTECTION	Indicates that the protection function is activated.*2

\*1 Executed in the ENCLIV or ENCNEU test of the TC measurement.  
 \*2 You will not be able to use the TOS3200 if the protection function is activated. Eliminate the cause of the protection status by referring to "Protection Function."

See p. 124

### Data input area

This area is used to enter items such as test conditions, sequence programs, and system settings.

The selected item is indicated with a underscore.

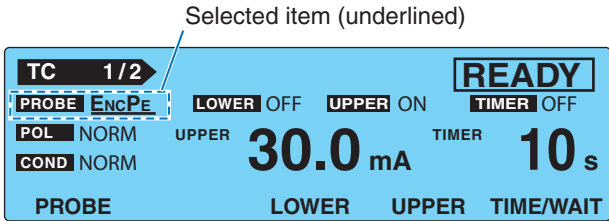

### Function key name

The available functions are displayed above function keys F1 to F5.

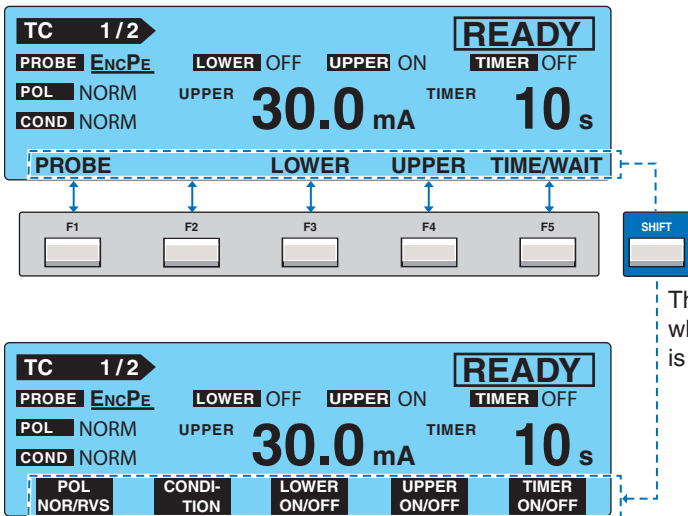

This display is shown while the SHIFT key is held down.

# Panel Control

## Switching the Screen

Each screen consists of multiple screens.

To display the next screen, press the NEXT (SHIFT+▶) key.

To display the previous screen, press the PREV (SHIFT+◀) key.

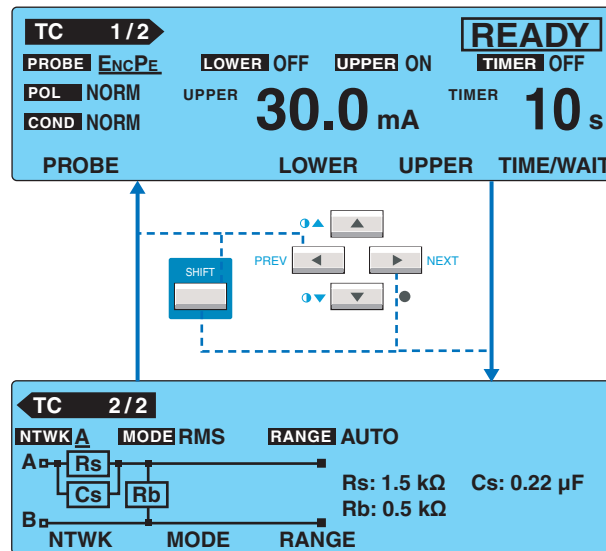

On the SYSTEM screen, <NEXT> (next screen) and <PREV> (previous screen) are assigned to the function keys.

## Selecting Items

There are two ways to select items.

- Move the underscore to the item you want to select using the arrow keys (▲▼◀▶).

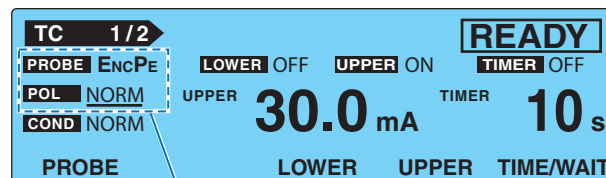

Press the ▼ key once when PROBE is selected to select POL.

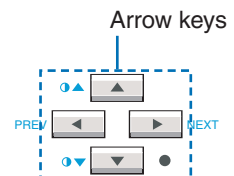



- Press the key corresponding to the function key name you want to select. If the item you want to select is not displayed, press the corresponding key while holding down the SHIFT key.

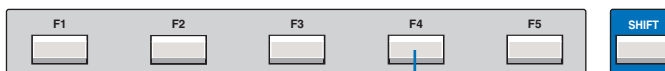
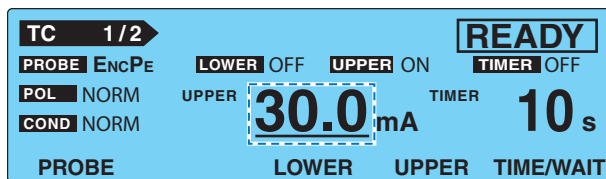

Press F4 to select UPPER (upper reference).

## Entering Data

- You can set the value for the item with an underscore by turning the rotary knob.

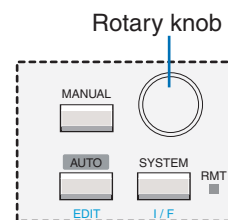
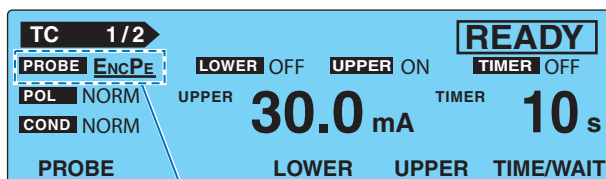

Turn the rotary knob to select the probe from ENCPE, ENCENC, ENCLIV, and ENCNEU.

- Depending on the item, you can enter the value by pressing a function key while holding down the SHIFT key to switch the selection.

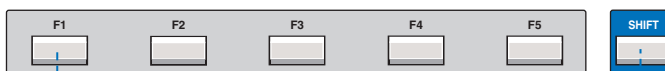
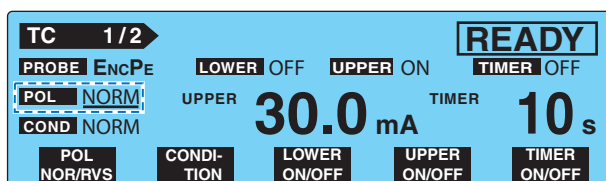

Press F1 while holding down the SHIFT key to select POL (NOR or RVS).

## Adjusting the Screen Brightness

See p. 120

You can set the screen brightness to any of the 11 levels (0 to 10).

Press the **◂▲** (SHIFT+▲) key to increase the brightness and the **◂▼** (SHIFT+▼) key to decrease the brightness. On the SYSTEM screen, you can adjust the brightness while viewing the setting.

- SYSTEM1/5>CONTRAST

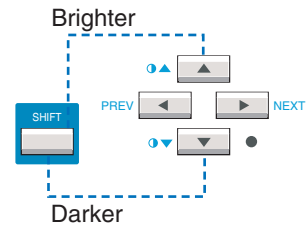

## Key Lock

The key lock function prevents the test conditions from being changed mistakenly by the key operation.

Press the KEY LOCK (SHIFT+LOCAL) key to lock the panel settings.

Only the START and STOP switches are enabled on the panel.

The message "KEY LOCK" is displayed on the screen while the key lock is enabled.

To release the key lock, press the KEY LOCK (SHIFT+LOCAL) key again.

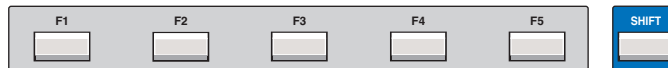
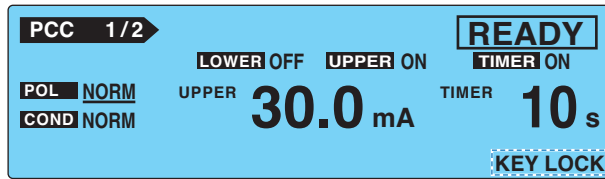

# Selecting the Operation Mode

## Single Tests (TC/PCC/METER)

The TOS3200 has three operation modes. Because each mode is independent, the TOS3200 can be used in any single operation mode.

A measurement in any of the following modes is called a single test.

- TC Measurement Mode
- PCC Measurement Mode
- Meter Mode (METER)

Each operation mode consists of two screens. Each time you press the MANUAL key, the screen changes as follows:

- When the first screen (1/2) is selected

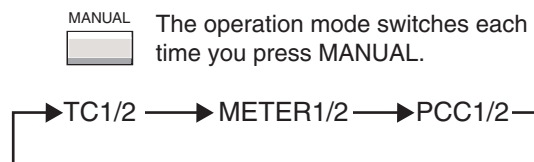

- When the second screen (2/2) is selected

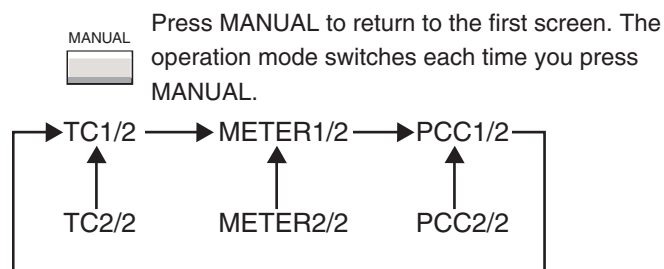

## Program Tests (AUTO)

See p. 73

You can also execute program tests that combine the TC measurement and PCC measurement modes. To select the program test, press the AUTO key. For details, see “Program Test.”

# Panel Memory

You can store up to 100 presets of test conditions.

## Test conditions that can be stored

- Settings on the TC measurement screen (TC1/2 and 2/2)
- Settings on the PCC measurement screen (PCC1/2 and 2/2)

Each memory can store either of the settings above. The settings of a specific mode are stored by carrying out the storage operation with the screen of the operation mode that you want to store.

## Panel memory status

STO	Indicates that the storing operation is in progress. A condition in which the area for storing the present settings has not been determined.
MEM	A condition in which the panel memory to be stored or recalled has been set.
RCL	Indicates that the recall operation is in progress. A condition in which the panel memory to be recalled has not been determined.

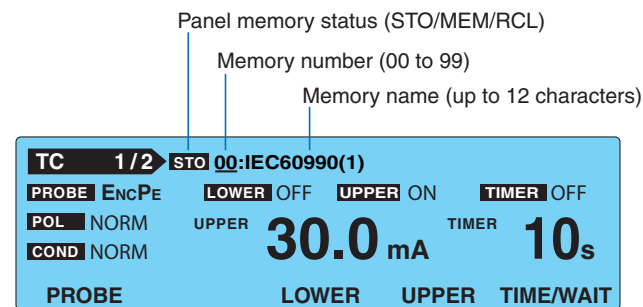

## Preset panel memories

Test conditions of TC measurement conforming to various safety standards are written in advance to memory numbers 00 to 50. Select the memory number according your test application.

For details on the written contents, see “Default Values of the Panel Memory.”

See p. 118

## Storing to the Test Conditions

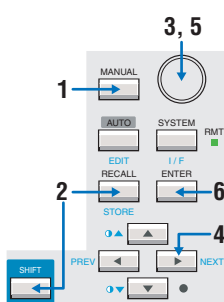

- 1** Press the **MANUAL** key to display the screen of the operation mode you want to store (TC or PCC measurement), and set the test conditions.
- 2** Press the **STORE (SHIFT+RECALL)** key.  
“STO” followed by “memory number: memory name” are displayed to the right of the screen title.
- 3** Use the rotary knob to set the memory number (00 to 99) of the test conditions you want to store.  
To cancel the storage operation, press the ▲ or ▼ key.
- 4** Press the ► key to move the cursor to the memory name.
- 5** Use the rotary knob to enter the name.  
Up to 12 of the characters shown in Table 3-1 can be entered.
- 6** Press the **ENTER** key to store the test conditions to the memory number.  
When the storage is complete, the characters “STO” will change to “MEM.”

Table 3-1 Characters that can be entered

	0	1	2	3	4	5	6	7	8	9	A	B	C	D	E	F
20		!	"	#	\$	%	&	'	(	)	*	+	,	-	.	/
30	0	1	2	3	4	5	6	7	8	9	:	;	<	=	>	?
40	@	A	B	C	D	E	F	G	H	I	J	K	L	M	N	O
50	P	Q	R	S	T	U	V	W	X	Y	Z	[	\	]	^	_
60	`	a	b	c	d	e	f	g	h	i	j	k	l	m	n	o
70	p	q	r	s	t	u	v	w	x	y	z	{		}	~	

Double quotation mark (22H), single quotation mark (27H), comma (2CH), and @ (40H) cannot be entered.

## Recalling from the Test Conditions

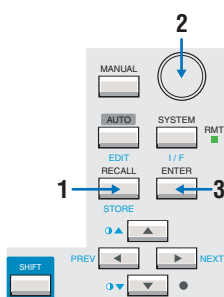

- 1** Press the **RECALL** key.  
“RCL” followed by “memory number: memory name” are displayed to the right of the screen title.
- 2** Use the rotary knob to set the memory number (00 to 99) of the test conditions you want to recall.  
To cancel the recall operation, press the ▲ or ▼ key.
- 3** Press the **ENTER** key to recall the test conditions of the specified memory number.  
When the recall is complete, the characters “RCL” will change to “MEM.”

If you change the test conditions that you recalled, the memory number will disappear. The memory number will not be displayed again even if you set the test conditions back to the original conditions.

This page has been intentionally left blank.





# 4

---

## TC and PCC Tests

This chapter explains the procedures from setting the test conditions to saving the test results for the touch current and protective conductor current measurement tests.

# Connecting the EUT

## Using the Output on the Front Panel

Connect the power cord of the EUT to the outlet (AC LINE OUT) on the front panel.

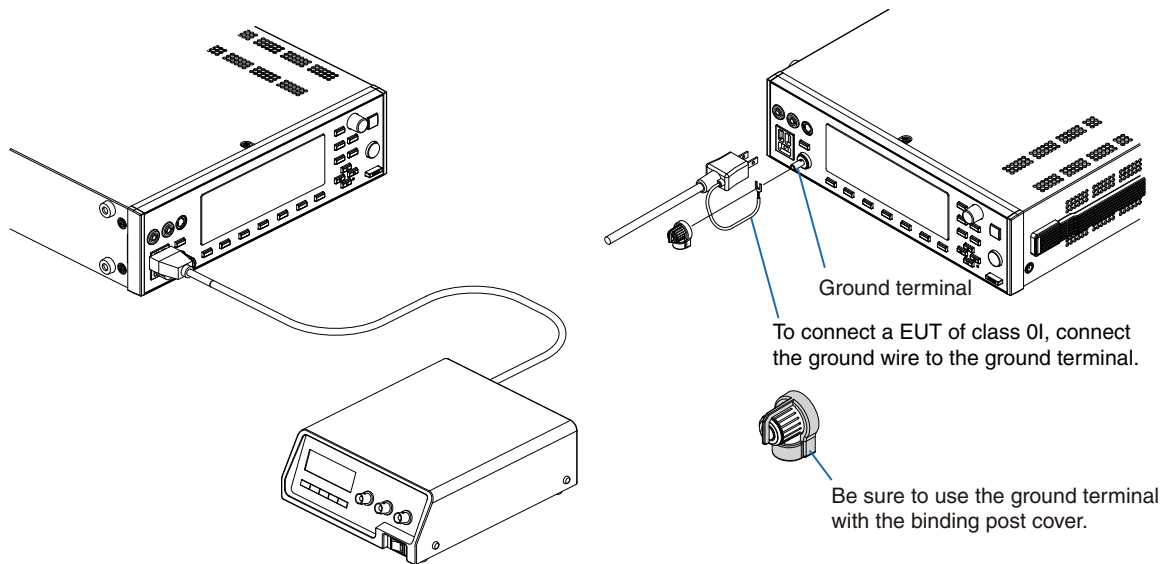

Fig. 4-1 Connection for the PCC measurement



**Electric shock may occur. In case of measuring the touch current in the condition of “Earth line disconnected status” of the EUT, a hazardous voltage may apply to the ground terminal. Do not touch the ground terminal while the test is in progress.**

The outlet on the front panel is a NEMA5-15 outlet for 100-V systems. However, if the plug cannot be connected physically (as may be the case with some AC adapters), use a power strip or the like.

See p. 40

Use the terminal block on the rear panel to connect a plug for 200-V systems. You can connect many of the popular plugs around the world by connecting the optional multi outlet to the terminal block.

## Using the Terminal Block on the Rear Panel

If the power cord plug of the EUT does not match the output on the front panel, use the AC LINE OUT terminal block on the rear panel.

The outlet and the terminal block are connected in parallel inside the TOS3200. Do not connect EUTs to both the outlet and the terminal block at the same time.





- **WARNING** Electric shock may occur. Be sure to remove the power cord from the AC inlet for the EUT before making the connection.
- The voltage applied to the AC inlet for the EUT appears at the AC LINE OUT terminal block. If you are not using the terminal block, cover the terminals with the terminal cover.

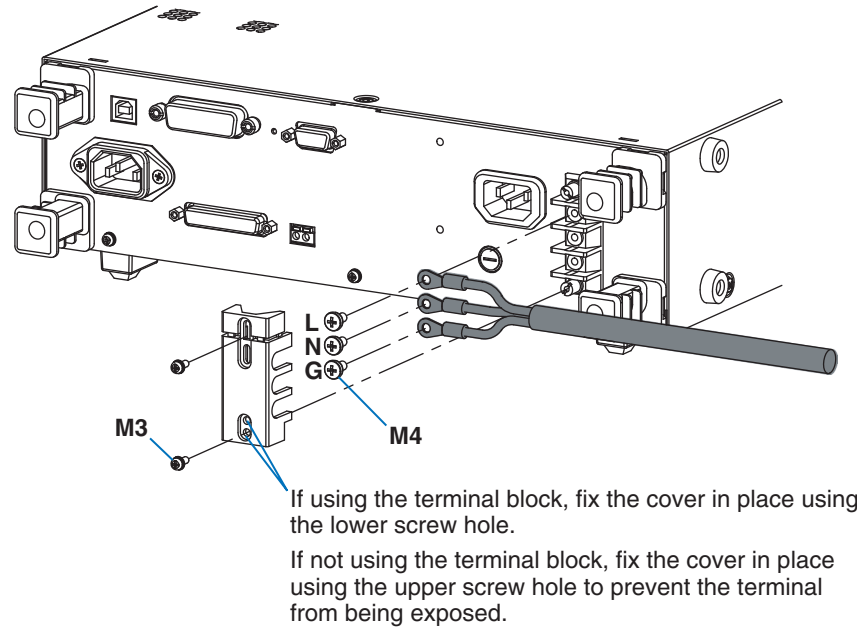

Fig. 4-2 Connecting to the AC LINE OUT terminal block

## Using the Optional Multi Outlet (OT01-TOS)

You can connect ordinary plugs available around the world in case the optional Multi Outlet (OT01-TOS) is used. For details, see the OT01-TOS Operation Manual.

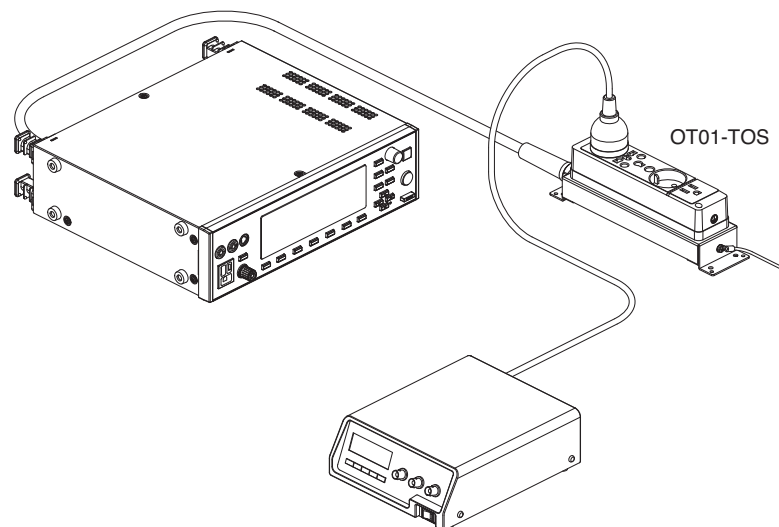

Fig. 4-3 Application example of the OT01-TOS

## Checking the EUT Operation

The power is supplied through the power line for the EUT only during the test. To check the EUT operation before the test, use the LINE ON key.

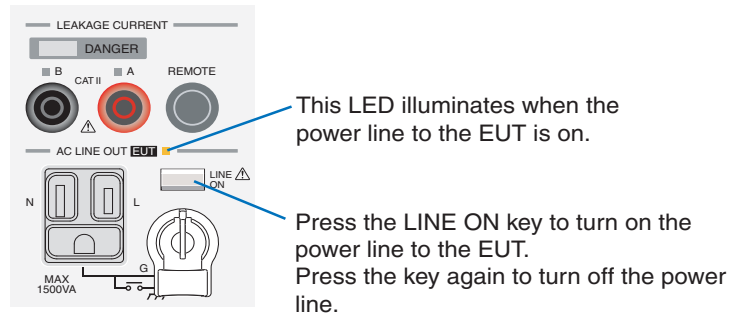

Fig. 4-4 LINE ON key

**NOTE**

Check the connection of the power line of the EUT before pressing the LINE ON key. If the LINE ON LED is illuminated, the power for the EUT is supplied to the outlet on the front panel and the AC LINE OUT terminal block on the rear panel.

## OVER LOAD PROTECTION indication

See p. 124

If a current greater than or equal to 15.75 A flows through the power line of the EUT or the power consumption of the EUT exceeds 1500 VA, the overload protection will be activated, and the power line will be shut off. If this happens, the screen will display "OVER LOAD PROTECTION," and the TOS3200 will enter the protection status. To release the protection status, disconnect the EUT, and press the STOP switch.

## Connecting the Test lead (TL21-TOS)

The test lead is used in the TC measurement.



**Electric shock may occur. Do not touch the tip of the lead while using the test lead.**

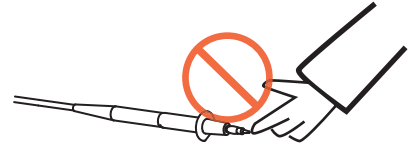

When you attach the included alligator clip to the test lead wire, remove the cap beforehand. To remove the cap, use a flat-blade type pocket screwdriver. Insert the tip of the screwdriver under the pawl of the cap, lift the pawl, and remove the cap.



**CAUTION** When removing the cap, be careful not to hurt your hands with the flat-blade screwdriver.

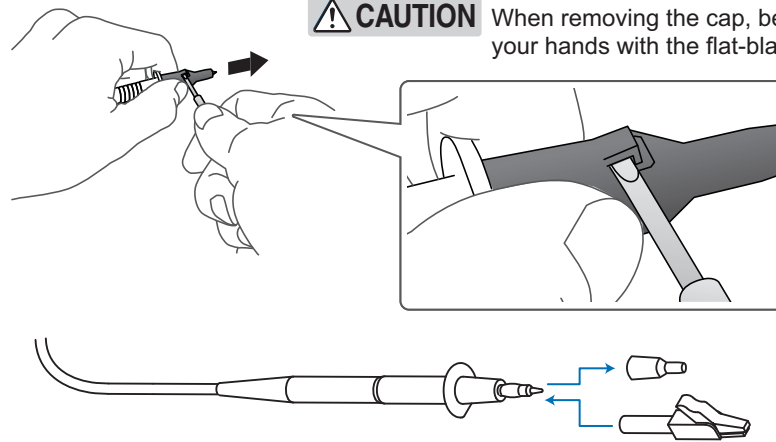

The red or black test lead is used separately according to the type of TC to be measured. The red and black test leads are connected to measurement terminals A and B, respectively.

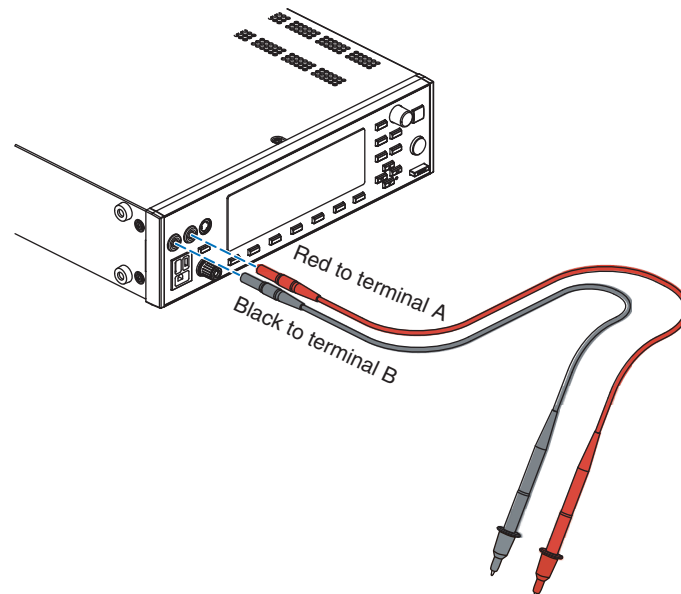

Fig. 4-5 Test lead usage

## Connecting the Test lead (TL21-TOS) (Cont'd)

The test lead connection varies depending on the type of TC to be measured and the EUT class.

Table 4-1 Test lead connections for the type of TC measurement

Setting		Connection destination of the test lead	
PROBE	COND	Class I equipment Class 0I equipment	Class II equipment
ENCPE	NORM	Connect test lead A to a part of the enclosure that is not connected to the protective ground [Connection a of Fig. 4-7].	Connect test lead A to the enclosure.
	FLTNEU		
	FLTPE	Connect test lead A to a part of the enclosure that is not connected to the protective ground [Connection a of Fig. 4-7] or a part that is connected to the protective ground.	
ENCENC	NORM	Connect test leads A and B to parts of the enclosure that is not connected to the protective ground (two isolated locations) [Connection b of Fig. 4-7].	Connect test leads A and B to the enclosure (two isolated locations).
	FLTNEU		
	FLTPE	Connect test leads A and B to parts of the enclosure that is not connected to the protective ground (two isolated locations) [Connection b of Fig. 4-7] or to a part that is not connected to the protective ground and a part that is connected to the protective ground [Connection c of Fig. 4-7].	
ENCLIV		Connect test lead A to a part of the enclosure that is not connected to the protective ground [Connection a of Fig. 4-7].	Connect test lead A to the enclosure.
ENCNEU			

Test lead A: Test lead connected to measurement terminal A  
 Test lead B: Test lead connected to measurement terminal B

If you select the PROBE item in the TC measurement screen (TC1/2), the LEDs located above the measurement terminals will illuminate for those that require the test leads to be connected.

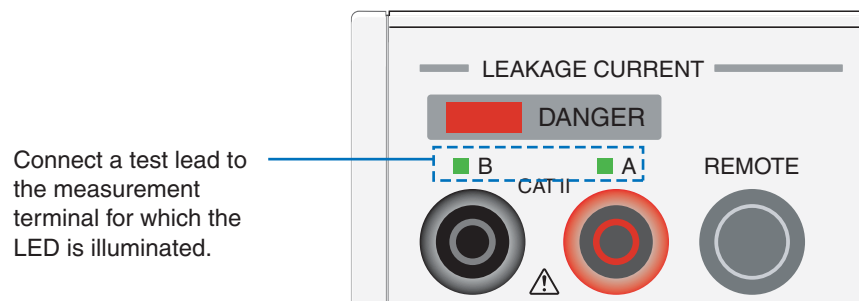

Fig. 4-6 LED connection indications

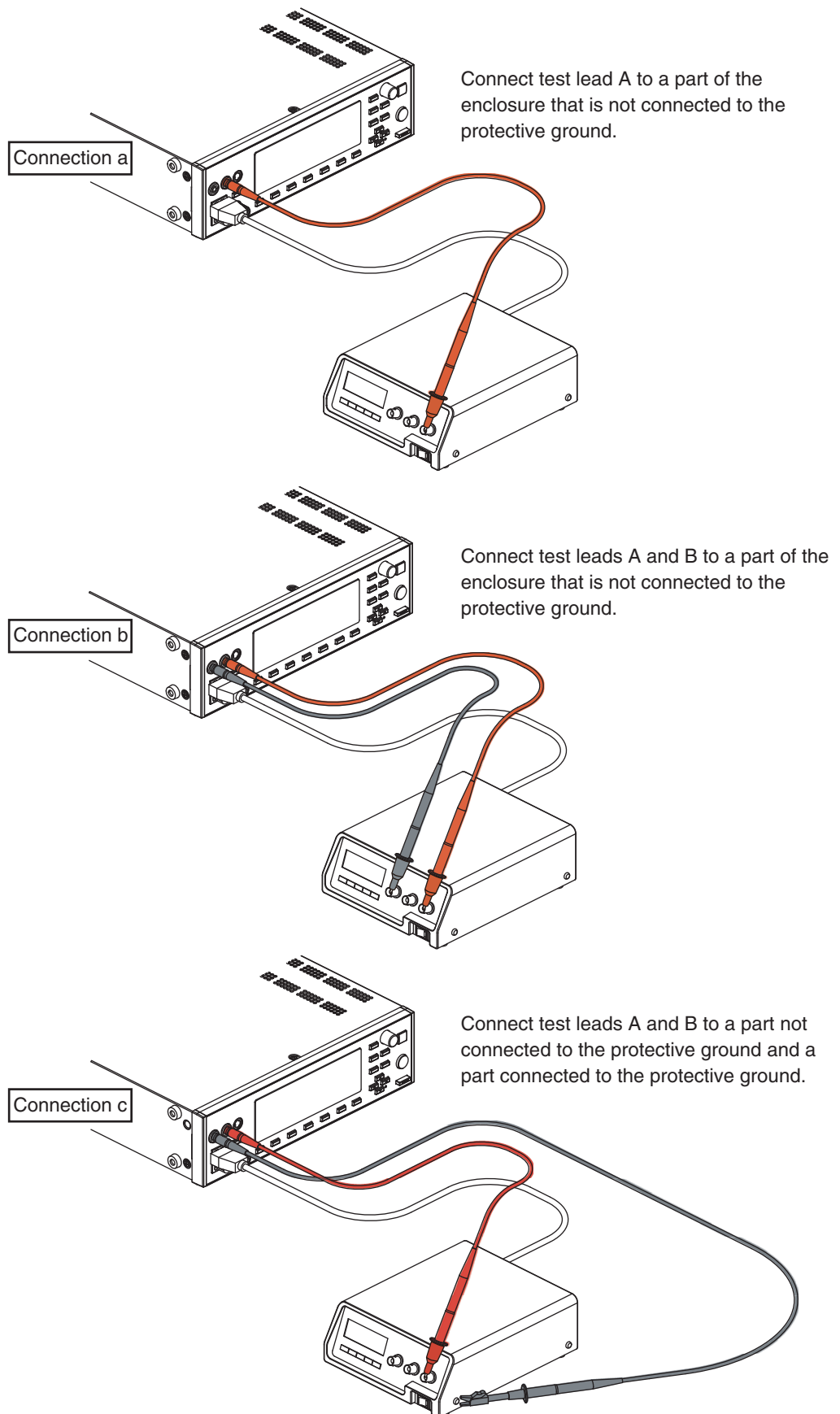

Fig. 4-7 Connection example for TC measurement

## Using the Flat Probe (FP01-TOS)

The flat probe is a type of sheet that measures the TC when the enclosure is touched with the palm of one's hand. The size of the metal foil (10 cm × 20 cm) complies with IEC 60990.

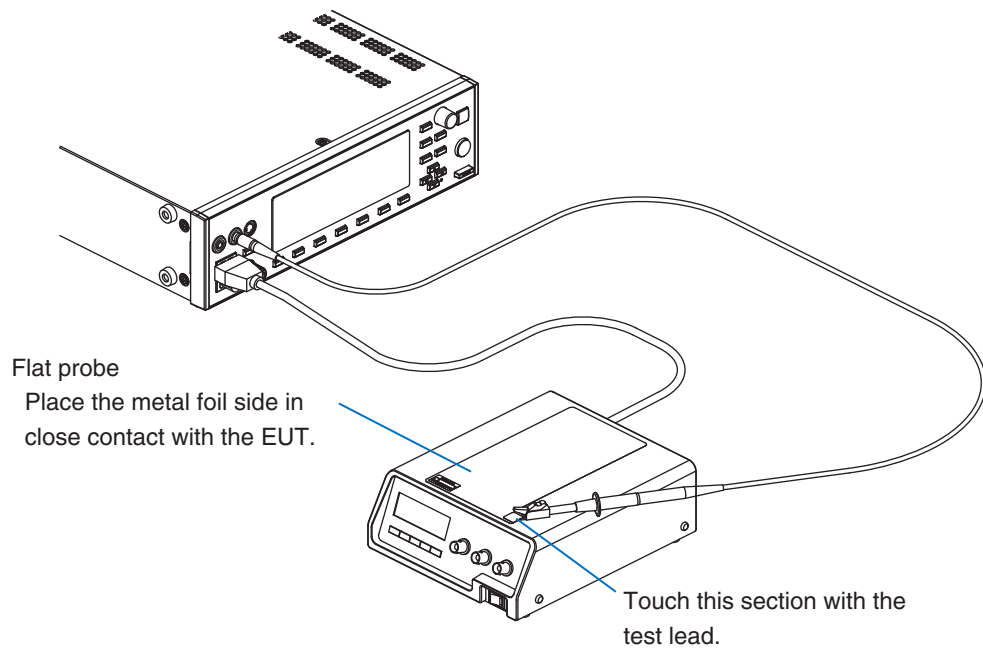

Fig. 4-8 Flat probe usage

## Using the Optional Test Probe (HP21-TOS)

You can start the test from your fingertips if you use the optional test probe in place of the test lead. For details, see the HP21-TOS Operation Manual.

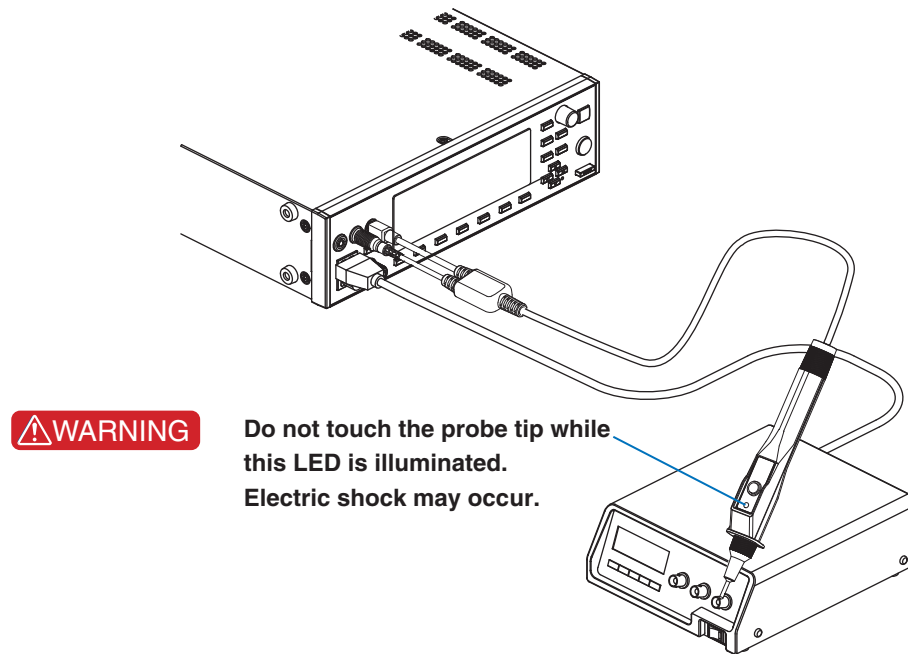

Fig. 4-9 Test probe usage

## Measurement Check

The measurement check verifies the operation of the current measurement circuit of the TOS3200 by running a low current between measurement terminals A and B. Because this check is performed using the test lead, it also checks for disconnection of the test lead.

We recommend that you execute the measurement check before starting the measurements. For details, see "Measurement Check."

See p. 100

# Judgment System

The TOS3200 judges PASS, L-FAIL, or U-FAIL with respect to a preset reference.

- **PASS** If the measured values are within the reference range up to the end of the test (TIMER 0 s), the TOS3200 will indicate PASS, and the test ends.
- **L-FAIL** If a current less than or equal to the lower reference is measured, the TOS3200 will indicate L-FAIL, but the test continues until the end of the test (TIMER 0 s).
- **U-FAIL** If a current greater than or equal to the upper reference is measured, the TOS3200 will indicate U-FAIL, and the test stops immediately.

Table 4-2 shows the judgments for measured values according to the TIMER, LOWER, and UPPER settings. Pass and L-FAIL are judged only if TIMER is ON.

## Validity of the Lower Reference

Normally, the TC and PCC of the same EUT are within a specified range of the EUT, but if the current is extremely small, it cannot be measured. Specifying LOWER ON and setting the lower reference to a value slightly smaller than the range specific to the EUT help to detect a disconnection or a bad connection of the test leads. This allows more reliable tests.

Table 4-2 Judgment patterns

TIMER	LOWER	UPPER	Measured value distribution		judgment
			Lower reference	Upper reference	
ON	ON	ON	[Distribution within range]		PASS
			[Distribution above upper reference]		U-FAIL
			[Distribution below lower reference]		L-FAIL
			[Distribution below lower reference]		U-FAIL
	OFF	ON	[Distribution within range]		PASS
			[Distribution below lower reference]		U-FAIL
	ON	OFF	[Distribution within range]		PASS
			[Distribution below lower reference]		L-FAIL
	OFF	OFF	[Distribution within range]		PASS



TIMER	LOWER	UPPER	Measured value distribution		judgment
			Lower reference	Upper reference	
OFF	ON*1	ON	[Measured value distribution]		-
			[Measured value distribution]		U-FAIL
			[Measured value distribution]		-
			[Measured value distribution]		U-FAIL
	OFF	ON	[Measured value distribution]		-
			[Measured value distribution]		U-FAIL
	ON*1	OFF	[Measured value distribution]		-
			[Measured value distribution]		-
OFF	OFF	[Measured value distribution]		-	

\*1. If TIMER is set to OFF, L-FAIL is not judged.

## Test Wait Time and Judgment

You can set the time until the test actually starts after you press the START switch. Measured values during the test wait time are ignored and do not affect the judgment as shown in Fig. 4-10. For example, if the test wait time is set longer than the startup time of the EUT, the measured values in the steady-state condition of the EUT can be evaluated.

The maximum measured value is not held during the test wait time.

See p. 120

- SYSTEM1/5 > MEAS MODE > MAX

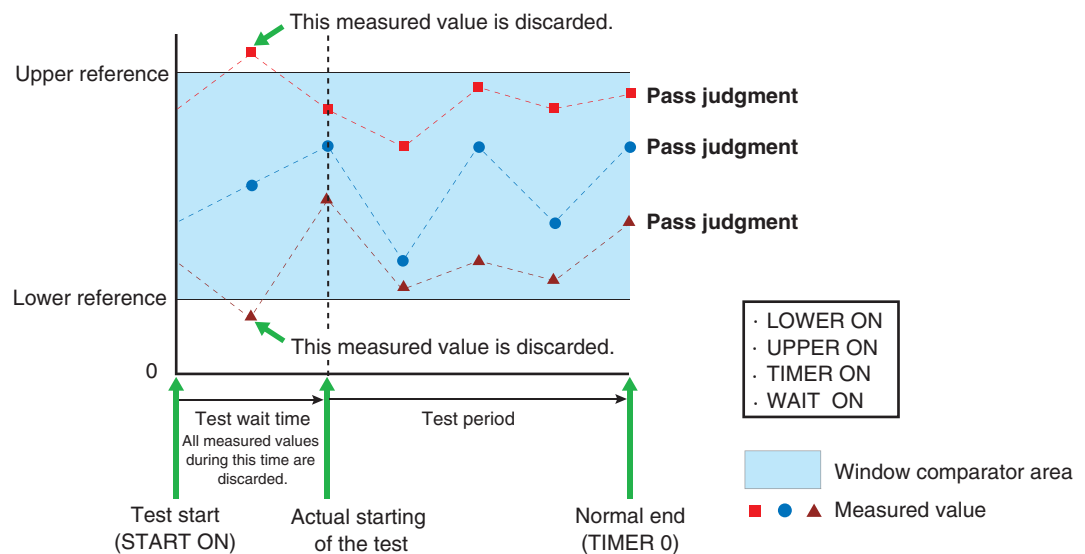
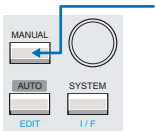

Fig.4-10 Measured values during the test wait time

# Setting Test Conditions of the TC Measurement



Press the MANUAL key to display the TC measurement screen 1/2 (TC1/2).  
The TC measurement screen consists of two screens (TC1/2 and 2/2).

See p. 29

For the procedure to select items and enter data, see “Panel Control Basics.”

See p. 40

For the procedure to connect the EUT, see “Connecting the EUT.”

## Setup Items of TC1/2 (PROBE / POL / COND)

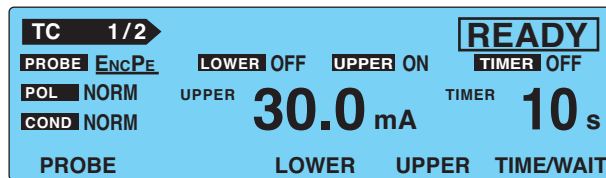

Item	Description	Panel operation
<b>PROBE</b>	Selects the connection destination of measurement terminals A and B.	PROBE (F1) key
	ENCPE <sup>*1</sup> Between the enclosure and earth	
	ENCENC <sup>*1</sup> Between two enclosures	Rotary knob
	ENCLIV Between the enclosure and power line (live)	
	ENCNEU Between the enclosure and power line (neutral)	
<b>POL</b> <sup>*2</sup>	Selects the polarity of the power line supplied to the EUT.	POL NOR/RVS (SHIFT+F1) ㊦
	NORM Positive phase connection	
	REVS Negative phase connection	
<b>COND</b> <sup>*2</sup>	Selects the single fault mode.	CONDITION (SHIFT+F2) key
	NORM Normal status	
	FLTNEU Power line (neutral) disconnected status	
	FLTPE <sup>*1</sup> Earth line disconnected status	

See

Table 4-1 on p. 44

<sup>\*1</sup> The following combinations are invalid for Class II EUTs without the ground wire.

PROBE	COND
ENCPE	FLTPE
ENCENC	FLTPE

<sup>\*2</sup> If the PROBE item is set to ENCLIV or ENCNEU, the following items cannot be selected. NORM is selected regardless of the present setting.

Fig. 4-11 shows how the relays inside the TOS3200 switch depending on the settings of the PROBE, POL, and COND items.

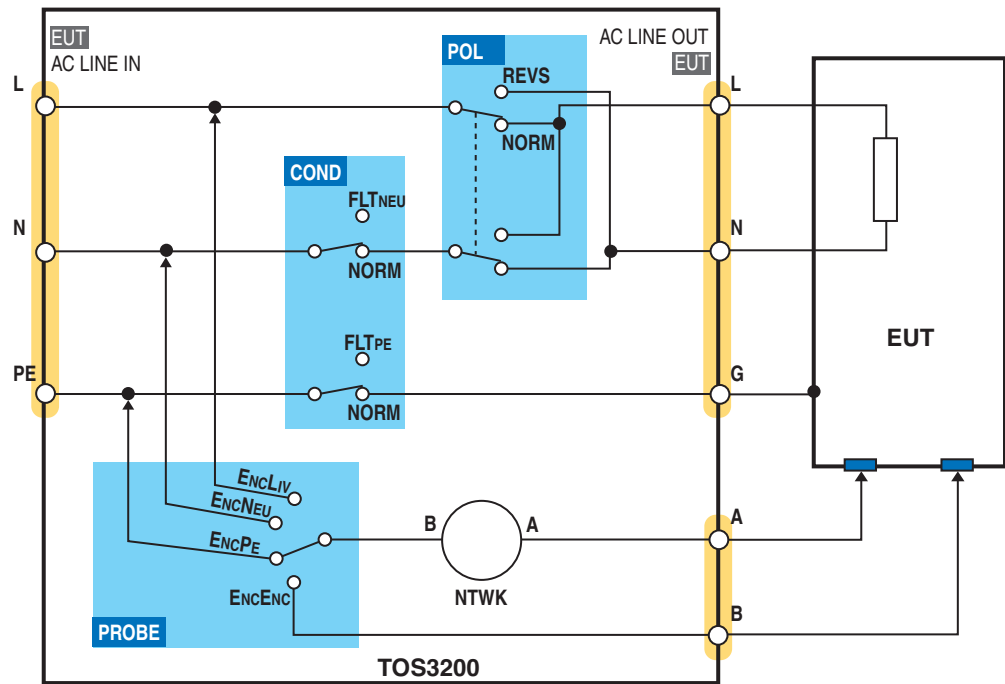

Fig. 4-11 Conceptual diagram of the TC measurement

### Earthing check

If the PROBE is set to ENCLIV or ENCNEU, measurement terminal A is connected to the EUT enclosure (floating section) and terminal B of the measurement network is connected to the power line (L or N) inside the TOS3200 to execute the test. Therefore, if the EUT enclosure is grounded, a dangerous earth fault will result through the NTWK. It is also possible that measurement terminal A is connected to the grounded section of the enclosure by mistake. It is necessary to check that the measurement point is not grounded in advance to perform the test safely.

The earthing check automatically performs this check. When you press the START switch, the TOS3200 supplies a low current between measurement terminals A and earth before the actual test, measures this current, and checks the grounding of the measurement point. If the measurement point is grounded, "↓FAIL" (CONTACT FAIL) will be indicated on the screen, and the test will be aborted.

Both the U-FAIL and L-FAIL signals are delivered from the SIGNAL I/O connector.

To clear CONTACT FAIL, press the STOP switch.

See p. 94

#### ⚠ CAUTION

If you connect the test lead to the measurement point after you press the START switch, the TOS3200 will judge that the measurement point is not grounded, and the earthing check will pass. If you do this, you cannot check mistakes in the connection. Be sure to connect the test lead to the measurement point first, and then press the START switch.

## Setup Items of TC1/2 (LOWER / UPPER / TIMER / WAIT)

See p. 48

For a description of the LOWER, UPPER, and TIME/WAIT settings, see also “Judgment System.”

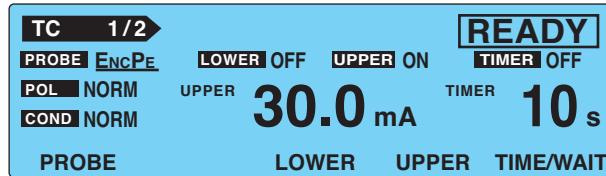

Item	Description	Panel operation
<b>LOWER</b>	Sets the lower limit of the judgment reference. If LOWER ON is specified and a current less than or equal to the lower reference is measured, L-FAIL judgment will result	LOWER (F3) key
	Lower reference	The selectable range varies depending on the NTKW (measurement network) and MODE (current measurement mode) settings on TC2/2. See Table 4-3. Rotary knob
	OFF	Disables the lower reference judgment. LOWER ON/OFF (SHIFT+F3) key
	ON	Enables the lower reference judgment.
<b>UPPER</b>	Sets the upper limit of the judgment reference. If UPPER ON is specified and a current greater than or equal to the upper reference is measured, U-FAIL judgment will result.	UPPER (F4) key
	Upper reference	The selectable range varies depending on the NTKW (measurement network) and MODE (current measurement mode) settings on TC2/2. See Table 4-3. Rotary knob
	OFF	Disables the upper reference judgment. UPPER ON/OFF (SHIFT+F4) key
	ON	Enables the upper reference judgment.
<b>TIMER WAIT</b>	Sets the test time (TIMER) or the test wait time (WAIT). If TIMER is selected, you can set the test time and TIMER ON/OFF. If WAIT is selected, you can set the test wait time and WAIT ON/OFF.	TIME/WAIT (F5) key
	Test time	Set the test time in the range of 1 s to 999 s. The test time will start when the test wait time elapses. Rotary knob
	TIMER OFF	The specified test time is discarded. Press the STOP switch to stop the test. TIMER ON/OFF (SHIFT+F5) key
	TIMER ON	The test will stop when the specified time elapses.
	Test wait time	Set the time until the test is actually started after the START switch is pressed (test wait time) in the range of 1 s to 999 s. Rotary knob
	WAIT OFF	The specified test wait time is discarded. WAIT ON/OFF (SHIFT+F5) key
WAIT ON	The actual test will start when the specified test wait time elapses.	

Table 4-3 Selectable range of LOWER/UPPER

MODE	NTWK A, B, B1,C	NTWK D, E	NTWK F	NTWK G
DC, RMS	30 $\mu$ A to 30.0 mA	30 $\mu$ A to 30.0 mA	30 $\mu$ A to 20.0 mA	30 $\mu$ A to 15.0 mA
PEAK	50 $\mu$ A to 90.0 mA	50 $\mu$ A to 45.0 mA	50 $\mu$ A to 30.0 mA	50 $\mu$ A to 22.5 mA

### Blinking UP <= LOW indication

If the lower reference is set to a value greater than or equal to the upper reference in the LOWER ON condition, “UP <= LOW” will blink at the upper right of the screen to indicate that the setting is invalid.

## Setup Items of TC2/2 (NTWK / MODE / RANGE)

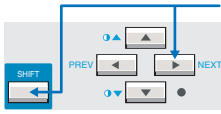

Press the NEXT (SHIFT+▶) key to display the TC measurement screen 2/2 (TC2/2).

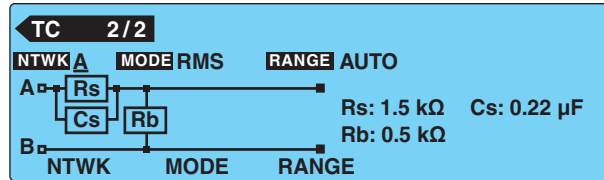

Item	Description	Panel operation
<b>NTWK</b>	Selects the measurement network.	NTWK (F1) key
A	(For IEC 60990) (1.5 kΩ // 0.22 μF) + 500 Ω	
B	(For IEC 60990) (1.5 kΩ // 0.22 μF) + 500 Ω // (10 kΩ + 22 nF)	
B1 <sup>*1</sup>	(For IEC 60065) (1.5 kΩ // 0.22 μF) + 500 Ω // (10 kΩ + 22 nF)	
C	(For IEC 60990) (1.5 kΩ // 0.22 μF) + 500 Ω // (10 kΩ + (20 kΩ + 6.2 nF) // 9.1 nF)	NTWK (SHIFT+F1) key
D	1 kΩ	
E	1 kΩ // (10 kΩ + 11.225 nF + 579 Ω)	
F	1.5 kΩ // 0.15 μF	
G	2 kΩ	
<b>MODE</b>	Selects the current measurement mode.	MODE (F2) key
RMS	RMS measurement	
DC	DC measurement	MODE (SHIFT+F2) key
PEAK	Peak measurement	
<b>RANGE</b>	Selects the measurement range.	RANGE (F3) key
AUTO	Automatically switches the range according to the measured value.	
FIX	Fixes the range. The measurement range is determined by the upper reference, measurement network (NTWK), and current measurement mode (MODE) settings. See Table 4-4.	RANGE (SHIFT+F3) key

See 114

<sup>\*1</sup> Measures voltage U1 between the measurement network reference points.

Table 4-4 Determination of the measurement range

Measurement range	MODE	Upper reference			
		NTWK A, B, B1,C	NTWK D, E	NTWK F	NTWK G
Range 1	DC, RMS	30 μA to 600 μA	30 μA to 300 μA	30 μA to 200 μA	30 μA to 150 μA
	PEAK	50 μA to 850 μA	50 μA to 424 μA	50 μA to 282 μA	50 μA to 212 μA
Range 2	DC, RMS	601 μA to 6.00 mA	301 μA to 3.00 mA	201 μA to 2.00 mA	151 μA to 1.50 mA
	PEAK	851 μA to 8.50 mA	425 μA to 4.24 mA	283 μA to 2.82 mA	213 μA to 2.12 mA
Range 3	DC, RMS	6.01 mA to 30.0 mA	3.01 mA to 30.0 mA	2.01 mA to 20.0 mA	1.51 mA to 15.0 mA
	PEAK	8.51 mA to 90.0 mA	4.25 mA to 45.0 mA	2.83 mA to 30.0 mA	2.13 mA to 22.5 mA

# Setting Test Conditions of the PCC Measurement

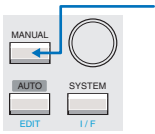

Press the MANUAL key to display the PCC measurement screen 1/2 (PCC1/2).  
The PCC measurement screen consists of two screens, PCC1/2 and 2/2.

See p. 30

For the procedure to select items and enter data, see “Screen Configuration.”

See p. 40

For the procedure to connect the EUT, see “Connecting the EUT.”

## Setup Items of PCC1/2 (POL / COND)

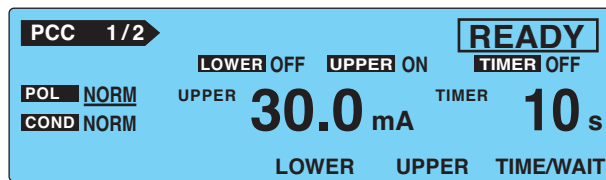

Item	Description	Panel operation
<b>POL</b>	Selects the polarity of the power line supplied to the EUT.	
	NORM      Positive phase connection	POL NOR/RVS (SHIFT+F1) key
	REVS      Negative phase connection	
<b>COND</b>	Selects the single fault mode.	
	NORM      Normal status	CONDITION (SHIFT+F2) key
	FLTNEU    Power line (neutral) disconnected status	

Fig. 4-12 shows how the relays inside the TOS3200 switch depending on the settings of the POL and COND items.

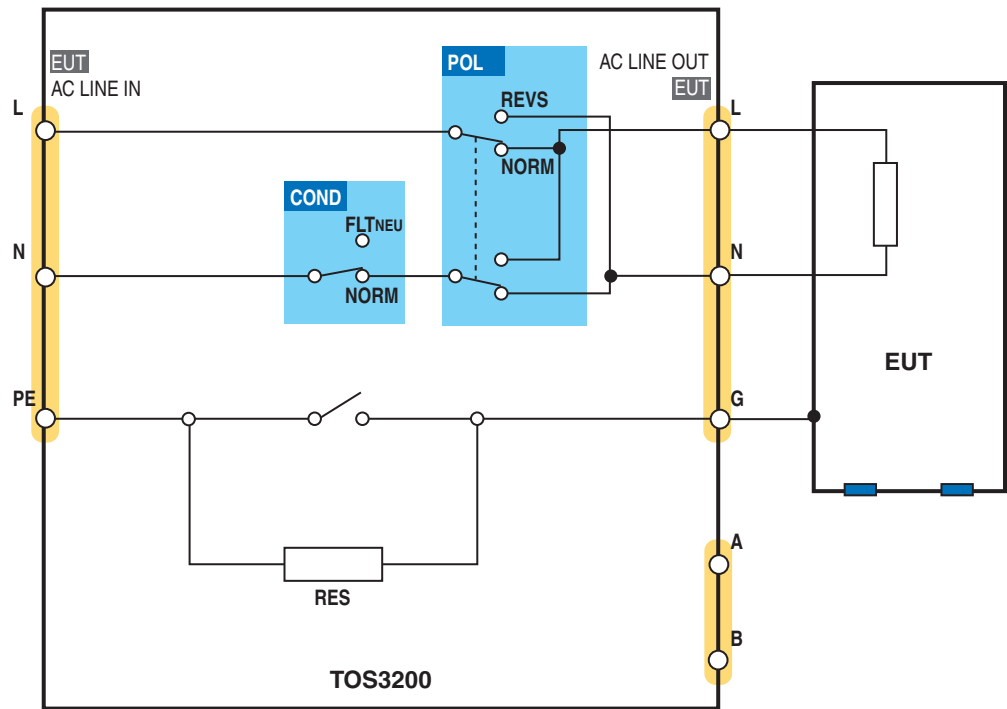
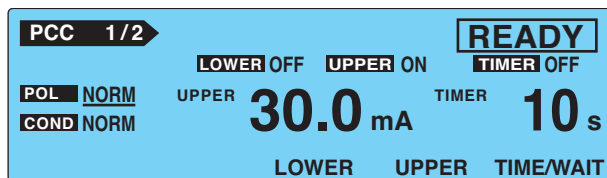

Fig. 4-12 Conceptual diagram of the PCC measurement

## Setup Items of PCC1/2 (LOWER / UPPER / TIMER / WAIT)

See p. 48

For a description of the LOWER, UPPER, and TIME/WAIT settings, see also “Judgment System.”



Item	Description	Panel operation
<b>LOWER</b>	Sets the lower limit of the judgment reference. If LOWER ON is specified and a current less than or equal to the lower reference is measured, L-FAIL judgment will result.	LOWER (F3) key
	Lower reference	The selectable range varies depending on the MODE (current measurement mode) setting on PCC2/2. See Table 4-5. Rotary knob
	OFF	Disables the lower reference judgment. LOWER ON/OFF (SHIFT+F3) key
	ON	Enables the lower reference judgment.
<b>UPPER</b>	Sets the upper limit of the judgment reference. If UPPER ON is specified and a current greater than or equal to the upper reference is measured, U-FAIL judgment will result.	UPPER (F4) key
	Upper reference	The selectable range varies depending on the MODE (current measurement mode) setting on PCC2/2. See Table 4-5. Rotary knob
	OFF	Disables the upper reference judgment. UPPER ON/OFF (SHIFT+F4) key
	ON	Enables the upper reference judgment.
<b>TIMER WAIT</b>	Sets the test time (TIMER) or the test wait time (WAIT). If TIMER is selected, you can set the test time and TIMER ON/OFF. If WAIT is selected, you can set the test wait time and WAIT ON/OFF.	TIME/WAIT (F5) key
	Test time	Set the test time in the range of 1 s to 999 s. The test time will start when the test wait time elapses. Rotary knob
	TIMER OFF	The specified test time is ignored. Press the STOP switch to stop the test. TIMER ON/OFF (SHIFT+F5) key
	TIMER ON	The test will stop when the specified time elapses.
	Test wait time	Set the time until the test is actually started after the START switch is pressed (test wait time) in the range of 1 s to 999 s. Rotary knob
	WAIT OFF	The specified test wait time is ignored. WAIT ON/OFF (SHIFT+F5) key
WAIT ON	The actual test will start when the specified test wait time elapses.	

Table 4-5 Selectable range of LOWER/UPPER

MODE	Selectable range
DC, RMS	30 $\mu$ A to 30.0 mA
PEAK	50 $\mu$ A to 90.0 mA



### Blinking indication UP <= LOW

If the lower reference is set to a value greater than or equal to the upper reference in the LOWER ON condition, "UP <= LOW" will blink at the upper right of the screen to indicate that the setting is invalid.

## Setup Items of PCC2/2 (MODE / RANGE)

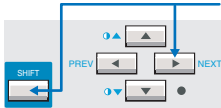

Press the NEXT (SHIFT+▶) key to display the PCC2/2 screen.

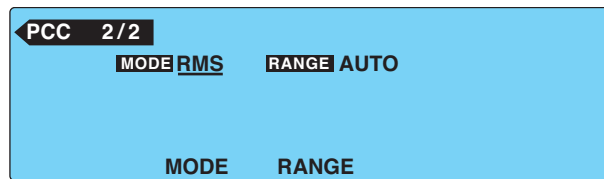

Item	Description	Panel operation
<b>MODE</b>	Selects the current measurement mode.	MODE (F2) key
	RMS      RMS measurement	
	DC        DC measurement	MODE (SHIFT+F2) key
	PEAK     Peak measurement	
<b>RANGE</b>	Selects the measurement range.	RANGE (F3) key
	AUTO      Automatically switches the range according to the measured value	
	FIX        Fixes the range. The measurement range is determined by the upper reference and current measurement mode (MODE) settings. See Table 4-6.	RANGE (SHIFT+F3) key

Table 4-6 Determination of the measurement range

Measurement range	MODE	Upper reference
Range 1	DC, RMS	30 μA to 600 μA
	PEAK	50 μA to 850 μA
Range 2	DC, RMS	601 μA to 6.00 mA
	PEAK	851 μA to 8.50 mA
Range 3	DC, RMS	6.01 mA to 30.0 mA
	PEAK	8.51 mA to 90.0 mA

# Setting Additional Test Conditions

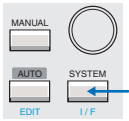

You can set the following functions in the system setup screen (SYSTEM1/5) in addition to the test conditions of the TC or PCC measurement.

- Maximum value hold function of the measured current (MEAS MODE)
- Hold time of the PASS judgment (PASS HOLD)
- Measured current conversion display (CONV)
- Buzzer volume (BUZ VOL)

SYSTEM1/5				
MEAS MODE	: NORM	BUZ VOL (PASS)	:	3
PASS HOLD	: 2.0s	BUZ VOL (FAIL)	:	3
CONV	: OFF	CONTRAST	:	5
SELV	: OFF	LINE BRK(AUTO)	:	ON
MEAS	PASS	CONV	SELV	<NEXT>

## Maximum Value Hold Function of the Measured Current (MEAS MODE)

This function holds and displays the maximum value measured during the test period. The maximum value is held for a single test. The held value is cleared when the test is completed.

See p. 49

The maximum measured value is not held during the test wait time.

- 1 Select the MEAS MODE on SYSTEM1/5.
- 2 Use the rotary knob to select the NORM or MAX.

NORM	Normal measurement (not hold the maximum value)
MAX	Hold the maximum value.

## Hold Time of the PASS Judgment (PASS HOLD)

The test result data can be stored to the memory when the judgment result is displayed. If the judgment result is FAIL, the screen will show the FAIL result until you press the STOP switch. Therefore, you can store the data during this period.

See p. 120

On the contrary, the display time of a PASS judgment result is 2.0 s (default value). Thus, you must store the test result data during this period. If you want to make sure to store the data for PASS judgments, set the display time of the PASS judgment result (PASS HOLD) to HOLD.

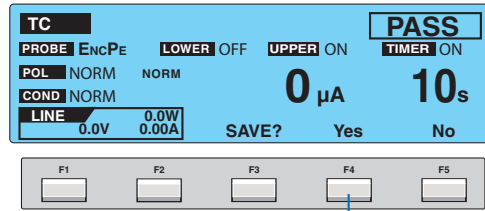

You cannot press the Yes (F4) key if the pass hold time is short.

- 1** Select the **PASS HOLD** on **SYSTEM1/5**.
- 2** Use the rotary knob to select the **PASS HOLD** time.

Time	Selectable range: 0.2 s to 10.0 s
HOLD	Hold until the STOP switch is pressed.

## Measured Current Conversion Display (CONV)

The TOS3200 has the CONV function that converts the measured current using the ratio between the measured value of the line voltage applied to the AC inlet for the EUT and the preset CONV voltage.

For example, if the line voltage is 100.0 V and you set the preset CONV voltage to 106.0 V, the TOS3200 will display the value equal to 106% of the measured current.

- 1** Select the **CONV** on **SYSTEM1/5**.
- 2** Use the rotary knob to set the voltage.

Voltage	Selectable range: 80.0 V to 300.0 V
OFF	Disable the conversion display.

## Buzzer Volume (BUZ VOL)

You can set the buzzer volume for PASS or FAIL judgments.

- 1** Select the **BUZ VOL** on **SYSTEM1/5**.  
Select the BUZ VOL (PASS) to set the buzzer volume for PASS judgments, or select the BUZ VOL (FAIL) to set the buzzer volume for FAIL judgments.
- 2** Use the rotary knob to set the buzzer volume (0 to 10).  
You can hear the buzzer volume by pressing the BUZ CHK (SHIFT+F5) key when BUZ VOL (PASS) or BUZ VOL (FAIL) is selected.

# Starting the Test



**WARNING** Electric shock may occur. Do not touch the tip of the lead while using the test lead.

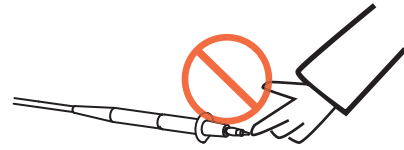

## Starting the Test

- 1 Check that the TOS3200 is connected correctly to the EUT.
- 2 On TC1/2 or PCC1/2 with “READY” displayed, press the START switch.

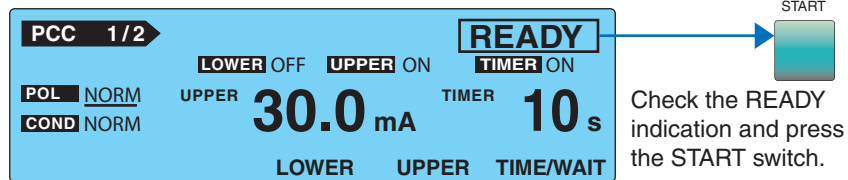

See p. 63

If you cannot start the test, see “Unable to Start the Test.”

## When the Test Starts

The DANGER lamp illuminates. (When the status is WAIT or TEST)

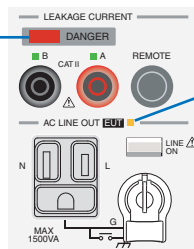

The power line to the EUT is turned on, and this LED illuminates.

### If WAIT is set to ON

See p. 49

The status changes to WAIT, and the test wait time starts counting down. When the test wait time reaches 0 s, the status changes to TEST, and the actual test starts.

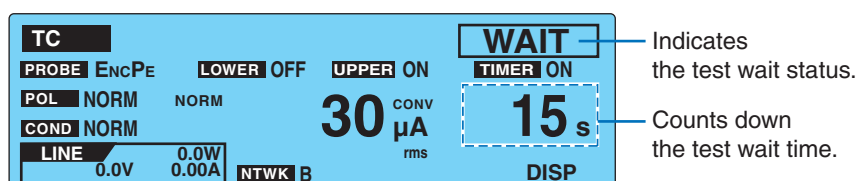

### If WAIT is set to OFF

The status changes to TEST, and the actual test starts.

Indicates whether the measured current is shown using the normal display (NORM) or maximum value display (MAX).

- SYSTEM1/5 > MEAS MODE

Indicates that the measured current is indicated after a conversion.

- SYSTEM1/5 > CONV

Indicates the test-in-progress status.

The time indication after starting the test varies depending on whether the timer is on or off.

Displays the voltage, current, and power of the power line applied to the AC inlet for the EUT.

Current measurement mode (RMS/DC/PEAK)

Measured current

TIMER ON	Displays the remaining time of the timer.
TIMER OFF	Displays the elapsed time of the test. If 999 s is exceeded, "999" will blink.

### The measured value is blinking

See p. 53 , p. 57

If the measured value exceeds the measurement range specified by AUTO or FIX, the measured value will blink. For the PCC measurement, see Table 4-6 on page 57. For the TC measurement, see Table 4-4 on page 53.

### ↑ FAIL (CONTACT FAIL) is displayed

See p. 51

An error has been detected in the earthing check. For details, see "Earthing check."

### CONV is displayed

If the current conversion display function is enabled and the power is not applied to the AC inlet for the EUT, "CONV" will be displayed. The conversion display function is invalid in this condition.

See p. 120

If you are supplying the EUT power from an external source (not from the TOS3200) in the TC measurement between two enclosures, turn the current conversion display function off.

- SYSTEM1/5>CONV

## Switching to Expanded Display

Press the DISP (F5) key while the test is in progress to switch the measured value display as follows:

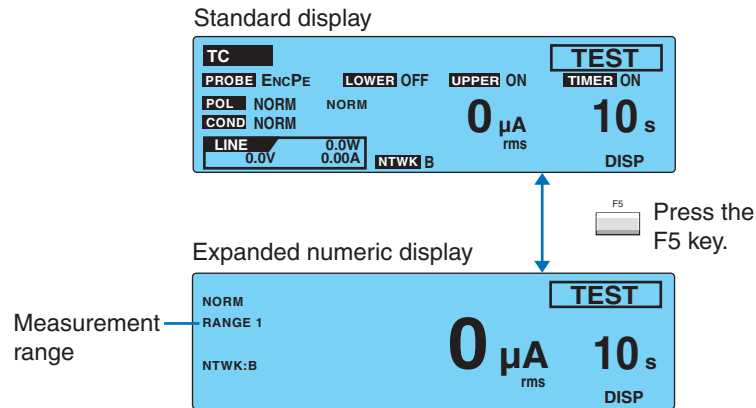

## Displaying the Voltage between the Measurement Network Reference Points

See 114

Press the V DISP (SHIFT+F5) key in expanded numeric display mode to display the measured voltage between the measurement network reference points.

This function is only valid for touch current testing.

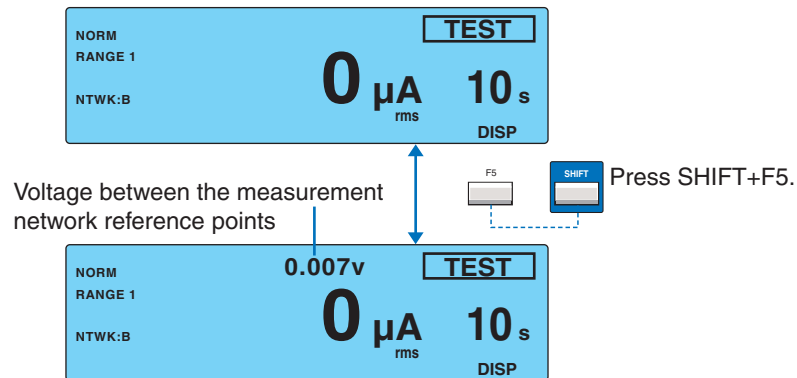

## Unable to Start the Test

### READY is not displayed

You will not be able to start the test in the following conditions.

- When TC2/2 or PCC2/2 is displayed.
- While recalling the panel memory or when the memory number has not been confirmed while storing to the memory.
- When the STOP switch is pressed (includes the condition in which the STOP signal is being applied to the SIGNAL I/O connector).
- When the power line of the EUT is turned on.

See p. 66

See p. 94

See p. 42

### PASS or FAIL is displayed

You cannot start test while the judgment result is displayed. Press the STOP switch to set the TOS3200 to READY status.

### PROTECTION is blinking

If "PROTECTION" is blinking on the screen, the TOS3200 is in the protection status. You cannot start the test in this status. Eliminate the cause of the protection status, and then start the test. For details, see "Protection Function."

See p. 124

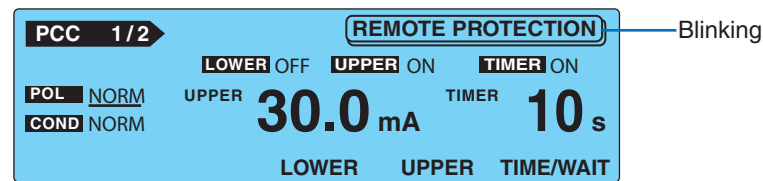

# Stopping the Test

## Aborting the Test

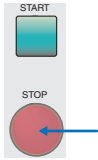

Press the STOP switch.

## When the Test Ends

The test will stop in any of the conditions below.

- When the test time has elapsed (when TIMER is ON).
- When a current greater than or equal to the upper reference is measured (U-FAIL).
- When you press the STOP switch.

When the test stops, the DANGER lamp will turn off, and the power line to the EUT will be turned off.

If the test stops in the case of condition a or b above, the judgment result will be displayed on the screen.

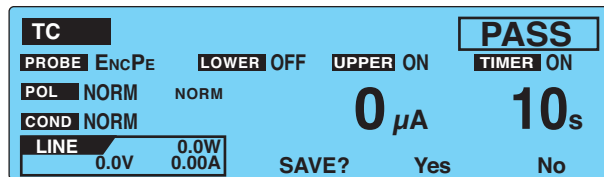

See p. 48

For details on how the TOS3200 judges the measured values, see “Judgment System.” Table 4-7 shows the TOS3200 operation when the test ends for each judgement result.

Table 4-7 Operation when the test ends

Operation	PASS	L-FAIL	U-FAIL
Display	Displays “PASS” on the screen.	Displays “↓FAIL” on the screen.	Displays “↑FAIL” on the screen.
Buzzer:	Sounds for 0.2 s.*1	Sounds until FAIL is cleared.	
SIGNAL I/O connector	Outputs the pass signal for the time specified by PASS HOLD.	Outputs the L-FAIL signal until FAIL is cleared.	Outputs the U-FAIL signal until FAIL is cleared.

\*1 The duration of the buzzer for a PASS judgment is fixed to 0.2 s. It does not depend on the PASS HOLD time.

## Storing the Test Result

See p. 65

The storage function is assigned to a function key while the judgment result is displayed. For details, see “Storing the Test Results.”

## Releasing the Judgment Result

Press the STOP switch to set the TOS3200 to READY status.



# Storing the Test Results

You can store up to 50 test results. The storage function is assigned to a function key while the judgment result (PASS or FAIL) is displayed.

- 1 Press the Yes (F4) key on the judgment result screen to display the MANUAL TEST DATA screen.

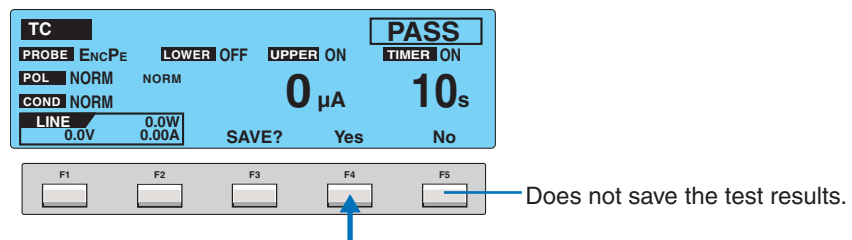

- 2 Press the arrow keys ( $\blacktriangle$   $\blacktriangledown$   $\blacktriangleleft$   $\blacktriangleright$ ) to select the desired memory number.

If you select a memory number in which a test result is already saved, the saved information is displayed.

For tests executed using test conditions that were recalled from the panel memory, the panel memory number and name are included in the saved information.

Panel memory number: memory name year/month/day hour:minute

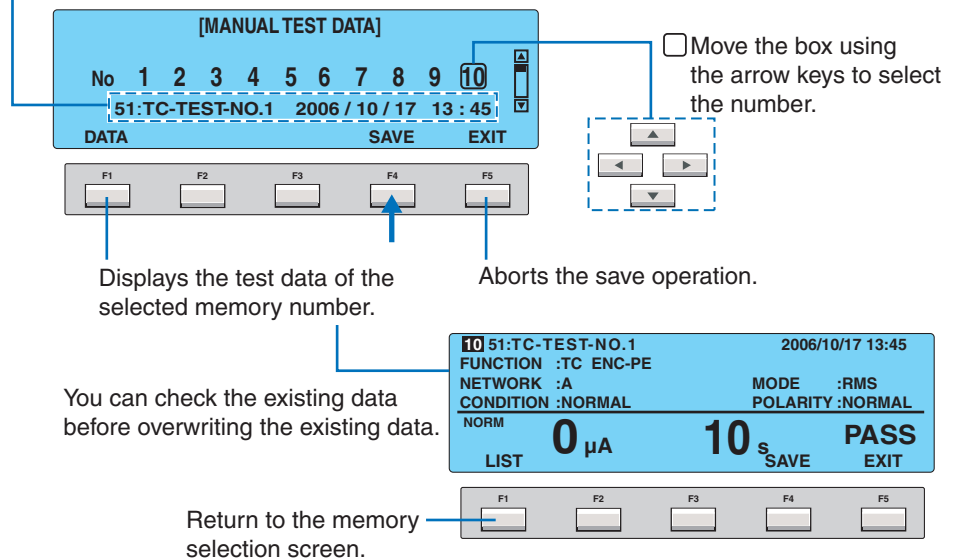

You can check the existing data before overwriting the existing data.

- 3 Press the SAVE (F4) key.

The stored information is displayed.

Press the DATA (F1) key to check the stored data.

- 4 Press the EXIT (F5) key.

The data store screen closes, and the TOS3200 changes to the READY status.

# Displaying the Test Results

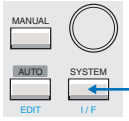

You can display the stored test results from the system setup screen 3/5 (SYSTEM3/5).

- 1 Press the **SYSTEM** key to display **SYSTEM1/5**.
- 2 Press the **<NEXT>** (F5) key twice to display **SYSTEM3/5**.

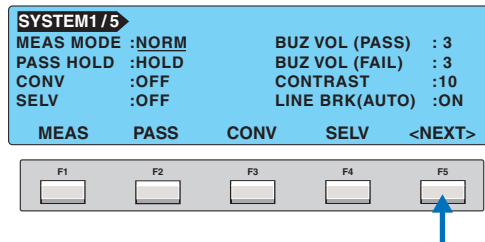

- 3 Press the arrow keys (**▲▼◀▶**) to select the desired memory number.

If you select a memory number in which a test result is already saved, the saved information is displayed.

For tests executed using test conditions that were recalled from the panel memory, the panel memory number and name are included in the saved information.

Panel memory number: memory name year/month/day hour:minute

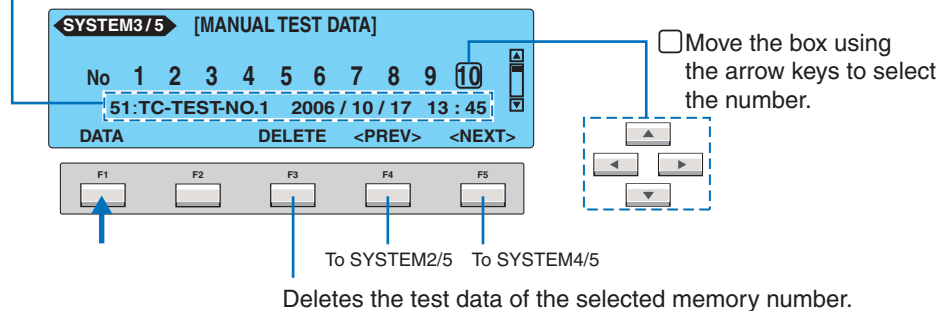

- 4 Press the **DATA** (F1) key.  
The stored test results are displayed.

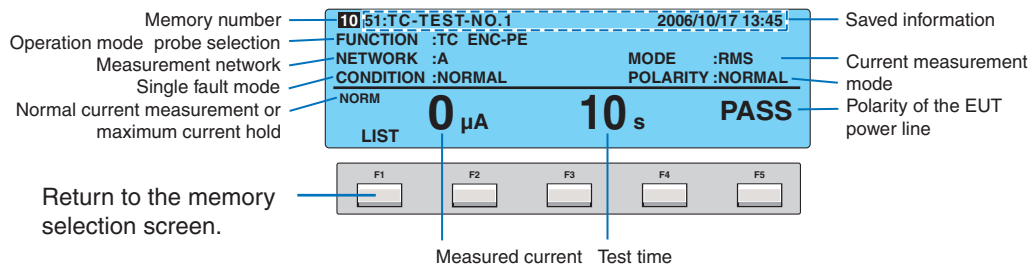

## Deleting the Stored Data

Select the memory number you want to delete in step 3 above, and press the **DELETE** (F3) key.



# 5

---

## Meter Mode Measurement

This chapter explains the touch current measurement in Meter Mode.

# Connecting the EUT

## Constructing the Connection Circuit

In meter mode measurement, an external circuit is constructed as shown in Fig. 5-1, and the current flowing between terminals A and B is measured. Fig. 5-1 illustrates the TC measurement between the enclosure and earth.

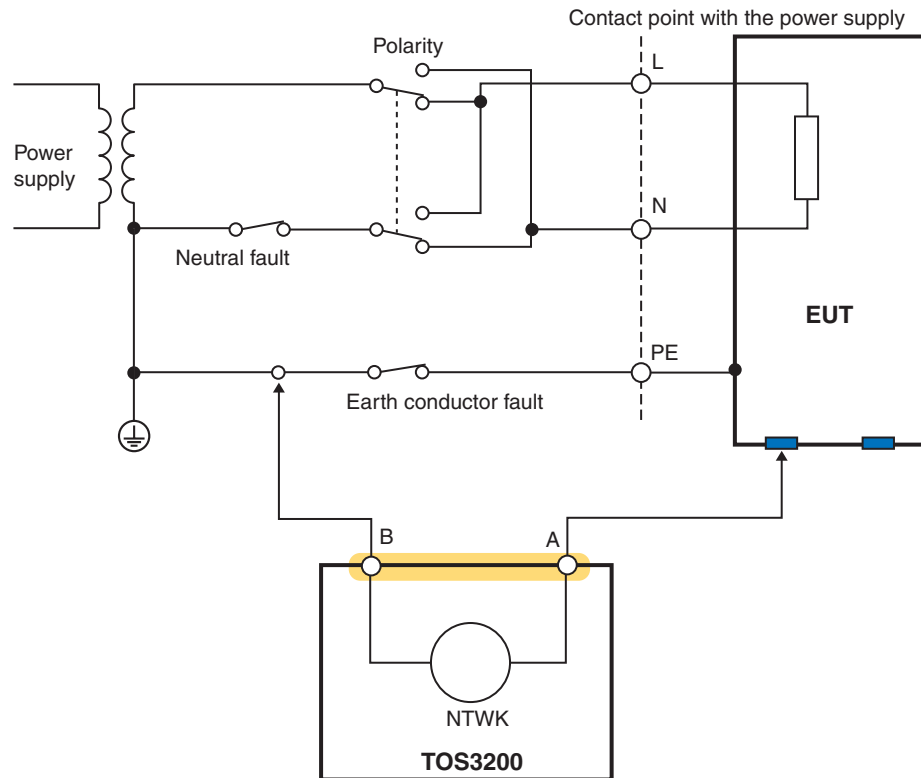

Fig. 5-1 Connection example in Meter Mode

## Connecting the Test lead (TL21-TOS)

The test lead is used in the TC measurement.



**Electric shock may occur. Do not touch the tip of the lead while using the test lead.**

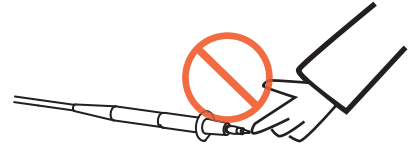

When you attach the included alligator clip to the test lead wire, remove the cap beforehand. To remove the cap, use a flat-blade type pocket screwdriver. Insert the tip of the screwdriver under the pawl of the cap, lift the pawl, and remove the cap.

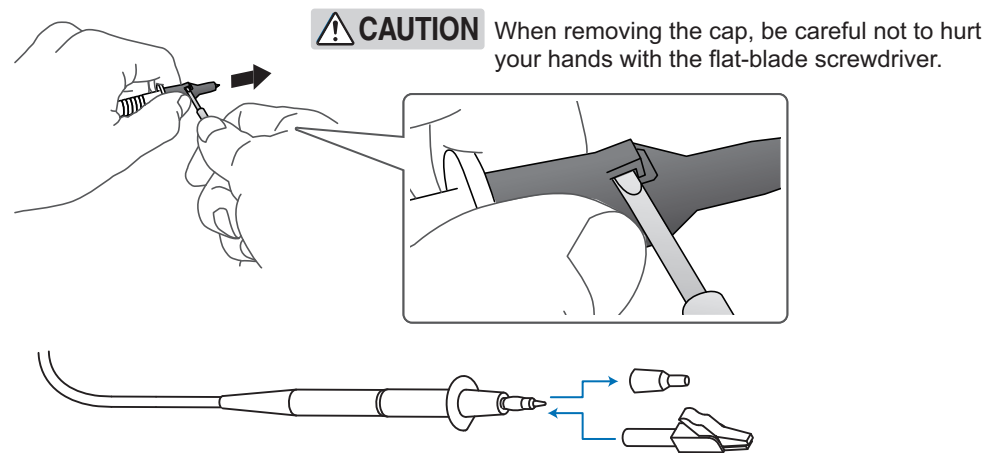

The red or black test lead is used separately according to the type of TC to be measured. The red and black test leads are connected to measurement terminals A and B, respectively.

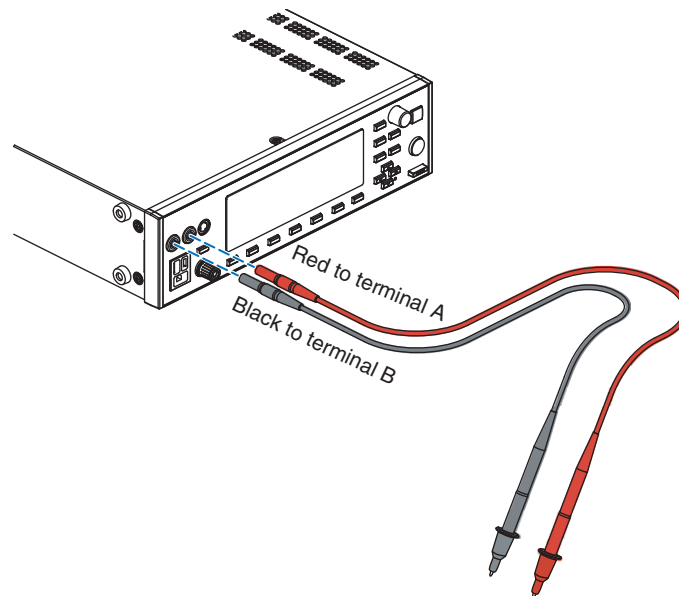

Fig. 5-2 Test lead usage

# Measuring in Meter Mode

In Meter Mode, the TOS3200 measures and displays the current flowing through measurement terminals A and B or the voltage between A and B as with a general multimeter. The TOS3200 does not judge the results against the reference.

Press the MANUAL key to display the meter mode measurement screen 1/2 (METER1/2).

The meter mode measurement screen consists of two screens (METER1/2 and 2/2). There are no items that you set on METER1/2. The displayed value is the present measured value.

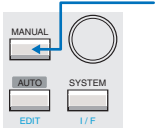

See p. 68

For the procedure to connect the EUT, see “Connecting the EUT.”

Indicates the selected measurement network. Displayed when the current is displayed.

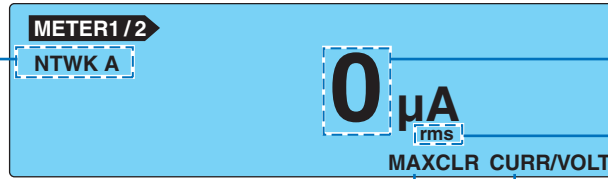

Current or voltage between measurement terminals A and B

Current measurement mode (RMS/DC/PEAK)

Clears the maximum measured value that is held. Displayed when MEAS MODE is set to MAX in SYSTEM1/5.

Switches between current measurement and voltage measurement.

## Displaying the voltage between the measurement network reference points

See 114

Press the V DISP (SHIFT+F5) key while the measured current is displayed to display the voltage between the measurement network reference points.

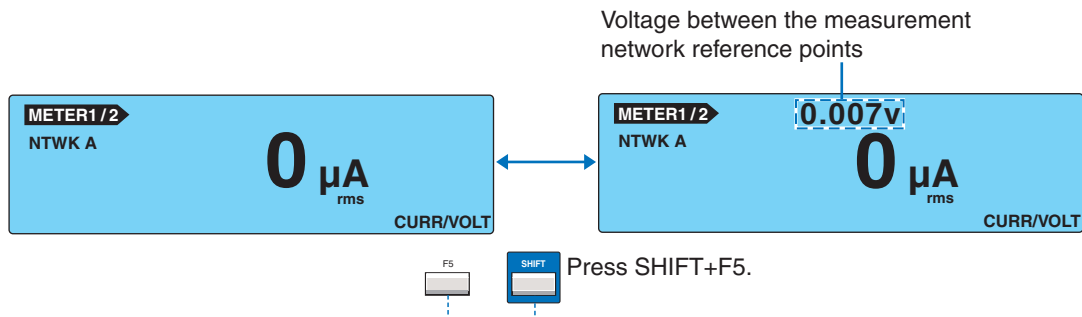

## Maximum Value Hold Function of the Measured Current (MEAS MODE)

This function holds and displays the maximum value measured.

The held maximum value is cleared when you press the MAXCLR (F4) key.

- 1** Select the MEAS MODE on SYSTEM1/5.
- 2** Use the rotary knob to select the NORM or MAX.

NORM	Normal measurement (not hold the maximum value)
MAX	Hold the maximum value.

## SELV Detection Function

If the voltage between measurement terminals A and B exceeds the preset safety extra low voltage (SELV), the DANGER lamp will illuminate.

The SELV detection is carried out while the voltage is displayed.

- 1 Select the SELV on SYSTEM1/5.
- 2 Use the rotary knob to set the SELV.

SELV	10 V to 99 V
MAX	Disable the SELV check function.

## Setup Items of METER2/2 (NTWK / MODE / RANGE)

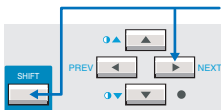

See p. 29

Press the NEXT (SHIFT+▶) key to display the METER2/2 screen.

For the procedure to select items and enter data, see “Panel Control Basics.”

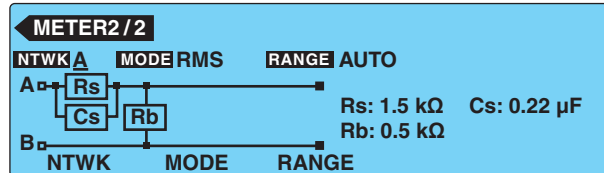

Item	Description	Panel operation
<b>NTWK</b> *1	Selects the measurement network.	NTWK (F1) key
A	(For IEC 60990) $(1.5\text{ k}\Omega // 0.22\ \mu\text{F}) + 500\ \Omega$	
B	(For IEC 60990) $(1.5\text{ k}\Omega // 0.22\ \mu\text{F}) + 500\ \Omega // (10\text{ k}\Omega + 22\text{ nF})$	
B1*2	(For IEC 60065) $(1.5\text{ k}\Omega // 0.22\ \mu\text{F}) + 500\ \Omega // (10\text{ k}\Omega + 22\text{ nF})$	
C	(For IEC 60990) $(1.5\text{ k}\Omega // 0.22\ \mu\text{F}) + 500\ \Omega // (10\text{ k}\Omega + (20\text{ k}\Omega + 6.2\text{ nF}) // 9.1\text{ nF})$	NTWK (SHIFT+F1) key
D	1 kΩ	
E	$1\text{ k}\Omega // (10\text{ k}\Omega + 11.225\text{ nF} + 579\ \Omega)$	
F	$1.5\text{ k}\Omega // 0.15\ \mu\text{F}$	
G	2 kΩ	

\*1 This item cannot be selected if voltage display is specified on METER1/2.

\*2 Measures voltage U1 between the measurement network reference points.

See 114

## NTWK, MODE, and RANGE Settings on METER2/2 (Cont'd)

Item	Description	Panel operation
<b>MODE</b>	Selects the electric current measurement mode.	MODE (F2) key
RMS	RMS measurement	MODE (SHIFT+F2) key
DC	DC measurement	MODE (SHIFT+F2) key
PEAK	Peak measurement	
<b>RANGE</b> <sup>*3</sup>	Selects the measurement range.	RANGE (F3) key
AUTO	Automatically switches the range based on the measured value.	
RANGE1	The measurement range is determined by the measurement network (NTWK) and current measurement mode (MODE) settings. See Table 5-1 for details.	RANGE (SHIFT+F3) key
RANGE2		
RANGE3		

<sup>\*3</sup> You cannot select this item if voltage display is specified on METER1/2. The voltage measurement range is as shown in Table 5-2 and is set to AUTO range.

Table 5-1 Measurement range of fixed ranges

Measurement range setting	MODE	Measurement range			
		NTWK A, B, B1, C	NTWK D, E	NTWK F	NTWK G
Range 1	DC, RMS	30 $\mu$ A to 600 $\mu$ A	30 $\mu$ A to 300 $\mu$ A	30 $\mu$ A to 200 $\mu$ A	30 $\mu$ A to 150 $\mu$ A
	PEAK	50 $\mu$ A to 850 $\mu$ A	50 $\mu$ A to 424 $\mu$ A	50 $\mu$ A to 282 $\mu$ A	50 $\mu$ A to 212 $\mu$ A
Range 2	DC, RMS	500 $\mu$ A to 6.00 mA	250 $\mu$ A to 3.00 mA	166 $\mu$ A to 2.00 mA	125 $\mu$ A to 1.50 mA
	PEAK	700 $\mu$ A to 8.50 mA	350 $\mu$ A to 4.24 mA	233 $\mu$ A to 2.82 mA	175 $\mu$ A to 2.12 mA
Range 3	DC, RMS	5.00 mA to 30.0 mA	2.50 mA to 30.0 mA	1.66 mA to 20.0 mA	1.25 mA to 15.0 mA
	PEAK	7.00 mA to 90.0 mA	3.50 mA to 45.0 mA	2.33 mA to 30.0 mA	1.75 mA to 22.5 mA

Table 5-2 Voltage measurement range

MODE	Measurement range
DC	10.00 V to 300.0 V
RMS	10.00 V to 300.0 V
PEAK	15.00 V to 430.0 V

### The measured value is blinking

If the measured value exceeds the measurement range specified by AUTO or a range setting, the measured value blinks.





# 6

---

## Program Test

This chapter describes how to create and edit sequence programs and how to execute the test.

# Program Tests

A sequence program allows various tests to be executed consecutively by changing the test conditions of the PCC or TC and the test lead connections.

For example, the following five tests can be executed consecutively by simply changing the test lead connections between each test (interval), and the result can be stored.

- 00 PCC measurement
- 01 TC measurement between the enclosure and earth
- 02 TC measurement between two enclosures
- 03 TC measurement between the enclosure and power line (live)
- 04 TC measurement between the enclosure and power line (neutral)

Up to 100 sequence programs can be created. You can assign a name to each program using a number between 00 and 99 and up to 12 characters.

Each sequence program can consist up to 100 single tests (100 steps). However, the total number of steps of all programs is 500. For example, up to five sequence programs consisting of 100 steps each can be created.

Press the AUTO key to display the program test screen 1/2 (AUTO1/2).

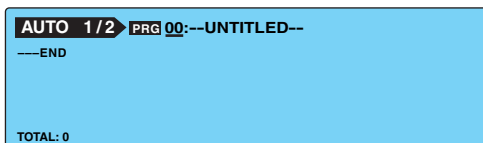
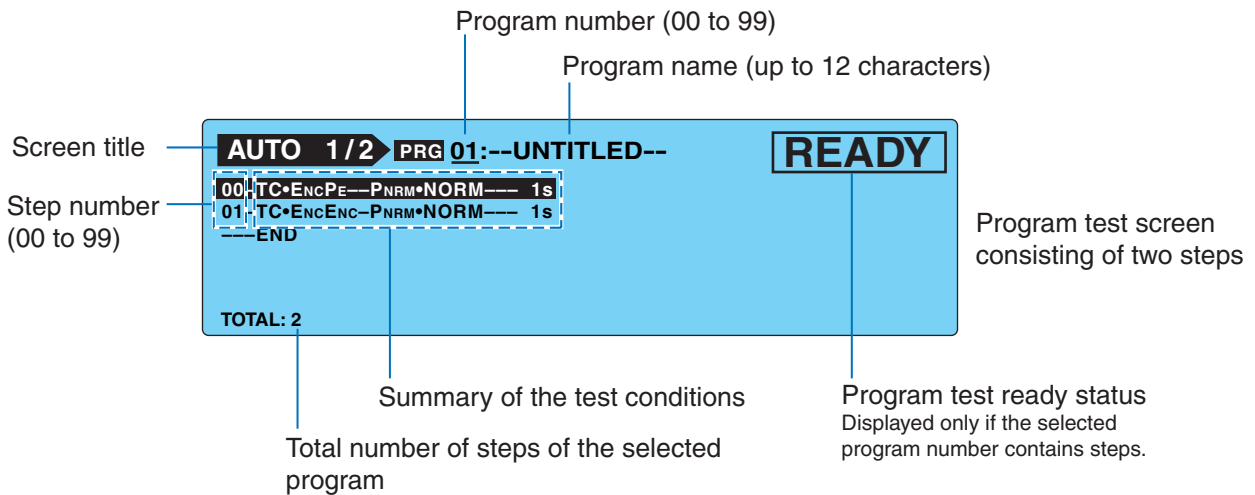

The screen when a program in which no steps are configured is selected

## Limitations on the Test Conditions in the Steps

You can set test conditions for each step of a program test in the same way as a single test. However, the following limitations exist.

- The measurement network (NTWK), current measurement mode (MODE), and measurement range (RANGE) settings are common to all steps. You cannot select different settings for each step.
- Panel memories cannot be recalled.
- The measured values cannot be displayed expanded while the test is in progress.

## Interval Time

You can set a pause time (interval) at the end of each step. If the TOS3200 shuts off the EUT power line during this interval, you can change the test lead connections.

For example, if the interval of step 01 is set to HOLD as shown in the example of Fig. 6-1, the test will not proceed to step 02 until you press the START switch after the end of the step 01 test. This allows you to change the test lead connection for sure.

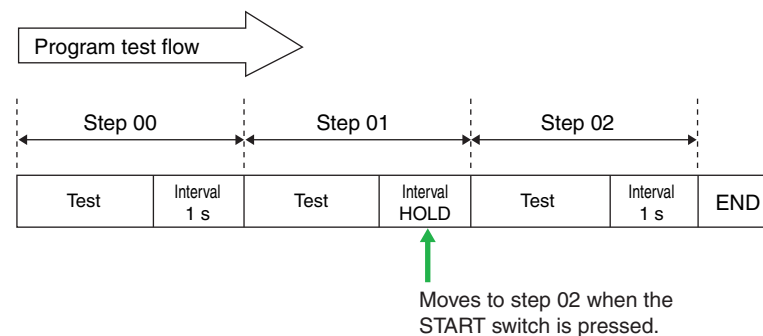

Fig. 6-1 Interval setting example

## Power Supply to the EUT

You can select whether to supply power (OFF) or not supply power (ON) to the EUT during the interval time.

- SYSTEM1/5 > LINE BRK (AUTO)

### NOTE

Even if you set LINE BRK (AUTO) to OFF, when the EUT power supply switches from a positive phase connection to a negative phase connection between steps, the TOS3200 does not supply power to the EUT. The only way that you can switch the connection is by shutting off the power supply

# Creating Sequence Programs

To create a sequence program, enter the edit screen from the program test screen.

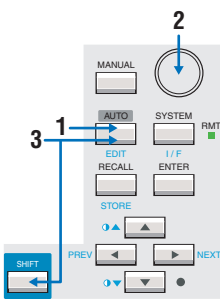

- 1 Press the AUTO key.**  
The program test screen 1/2 (AUTO1/2) appears.
- 2 Use the rotary knob to select a new program or the program you want to edit.**
- 3 Press the EDIT (SHIFT+AUTO) key.**  
“EDIT” appears on the screen, and the edit screen is displayed.

## Inserting a Step in a New Program

The end of the step sequence is selected.

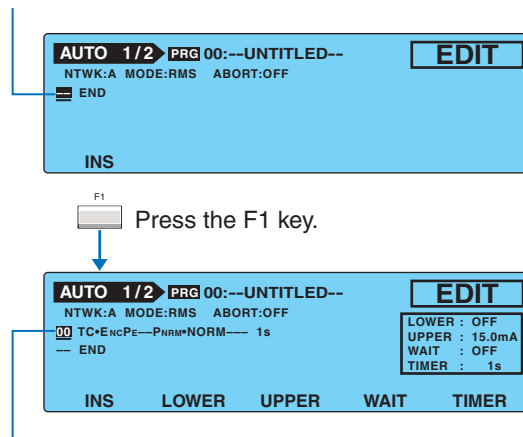

A step with a default value is inserted above END.

Default values of the step that is inserted

Item	Default value	items common to the step	Default value
Operation mode	TC	Measurement network (NTWK)	A
Connection destination of the measurement terminal (PROBE)	ENCPE	Current measurement mode (MODE)	RMS
Polarity of the EUT power line (POL)	NORM	Measurement range (RANGE)	AUTO
Single fault mode (COND)	NORM	Operation for FAIL judgment (ABORT)	OFF
Interval time	1 s		
Upper reference (UPPER)	15 mA		
Lower reference (LOWER)	OFF (30 μA)		
Test time (TIMER)	ON (1 s)		
Test wait time (WAIT)	OFF (1 s)		

## Inserting a Step in an Existing Program

Select the position where you want to insert a step.  
(The new step is inserted above the selected step.)

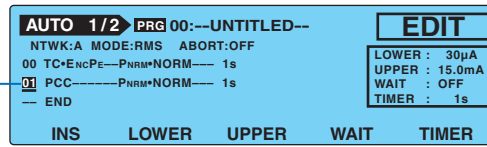

 Press the F1 key.

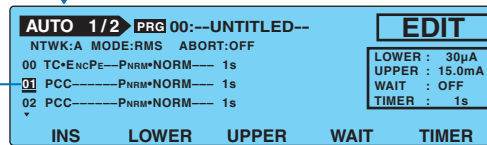



A copy of step 01 is inserted.  
(The selected step number does not change, but step 02 was step 01 before the INS key was pressed.)

## Deleting a Step

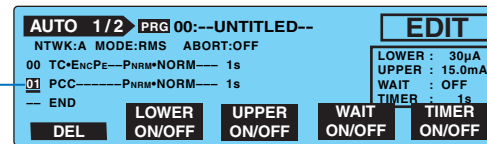
Select the step you want to delete.



  Press the SHIFT+F1 key.

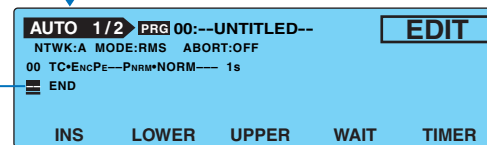

The selected pattern is deleted.

## Setup Items of AUTO1/2

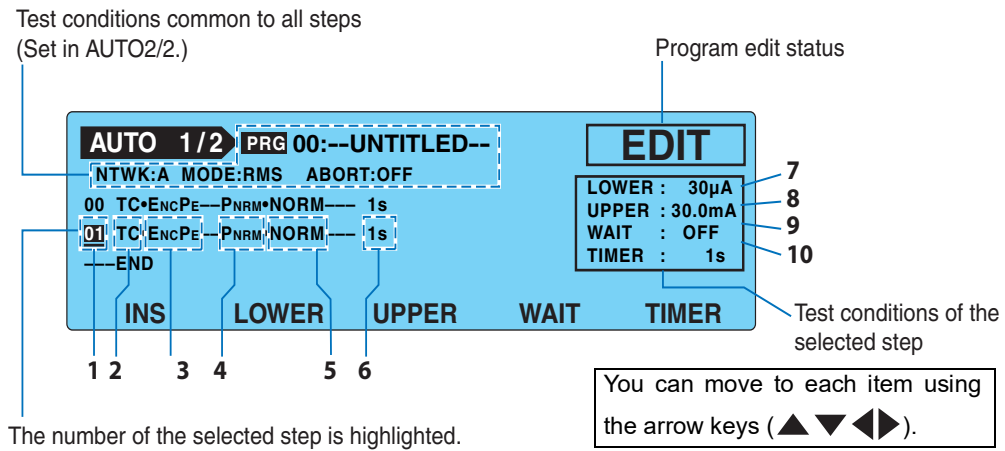

Item	Description	Panel operation
1 (Step number)	Selects the step number to be edited.	Rotary knob
2 (Operation mode)	Selects TC or PCC.	Rotary knob
3 (PROBE) <sup>*1</sup>	Selects the connection destination of measurement terminals A and B.	Rotary knob
	EncPE Connected between the enclosure and earth.	
	EncENC Connected between two enclosures.	
	EncLIV Connected between the enclosure and power line (live). EncNEU Connected between the enclosure and power line (neutral).	
4 (POL) <sup>*2</sup>	Selects the polarity of the power line supplied to the EUT.	Rotary knob
	PNRM Normal phase connection PRVS Reverse phase connection	
5 (COND) <sup>*2</sup>	Selects the single fault mode.	Rotary knob
	NORM Normal status	
	FLTNEU Power line (neutral) disconnected status FLTPE Earth line disconnected status	
6 (Interval)	Sets the time until the next step is executed in the range of 1 s to 99 s or HOLD. If set to HOLD, the next step will not start until you press the START switch.	Rotary knob
7 LOWER	Sets the lower limit of the judgment reference.	F2 key
	Lower reference The selectable range varies depending on the NTKW (measurement network) and MODE (current measurement mode) settings on AUTO2/2. See Table 6-1. You will not be able to enter the value if set to OFF.	Rotary knob
	ON/OFF The item is turned on when the value is displayed.	SHIFT+F2 key
8 UPPER	Sets the upper limit of the judgment reference.	F3 key
	Upper reference The selectable range varies depending on the NTKW (measurement network) and MODE (current measurement mode) settings on AUTO2/2. See Table 6-1. You will not be able to enter the value if set to OFF.	Rotary knob
	ON/OFF The item is turned on when the value is displayed.	SHIFT+F3 key

Item	Description	Panel operation
9 WAIT	Sets the test wait time.	
	Test wait time	Set the test wait time in the range of 1 s to 999 s. You will not be able to enter the value if set to OFF.
	ON/OFF	The item is turned on when the value is displayed.
10 TIMER	Sets the test time.	
	Test time	Set the test time in the range of 1 s to 999 s. You will not be able to enter the value if set to OFF.
	ON/OFF	The item is turned on when the value is displayed.

- \*1. You will not be able to select this item if you select PCC for item 2 (operation mode).
- \*2. You will not be able select this item if ENCLIV or ENCNEU is selected for item 3 (PROBE). Item 4 (POL) and 5 (COND) are set to PNRM and NORM, respectively, regardless of the present setting.

Table 6-1 Selectable range of LOWER/UPPER

MODE	TC measurement				PCC measurement
	NTWK A, B,B1, C	NTWK D, E	NTWK F	NTWK G	
DC, RMS	30 μA to 30.0 mA	30 μA to 30.0 mA	30 μA to 20.0 mA	30 μA to 15.0 mA	30 μA to 30.0 mA
PEAK	50 μA to 90.0 mA	50 μA to 45.0 mA	50 μA to 30.0 mA	50 μA to 22.5 mA	50 μA to 90.0 mA

### Earthing check

If the PROBE item is set to ENCLIV or ENCNEU, measurement terminal A is connected to the EUT enclosure (floating section) and terminal B of the measurement network (NTWK) is connected to the power line (L or N) inside the TOS3200 to execute the test. Therefore, if the EUT enclosure is grounded, a dangerous earth fault will result through the NTWK. It is also possible that measurement terminal A be connected to the grounded section of the enclosure by mistake. It is necessary to check that the measurement points is not grounded in advance to perform the test safely.

The earthing check automatically makes this check. When you press the START switch, the TOS3200 supplies a low current between measurement terminals A and earth before the actual test, measures this current, and checks the grounding of the measurement point. If the measurement point is grounded, “↓FAIL” (CONTACT FAIL) will be indicated on the screen, and the test will be aborted.

Both the U-FAIL and L-FAIL signals are delivered from the SIGNAL I/O connector. To clear CONTACT FAIL, press the STOP switch.

 p. 94

#### CAUTION

If you connect the test lead to the measurement point after you press the START switch, the TOS3200 will judge that the measurement point is not grounded, and the earthing check will pass. If you do this, you will not be able to check mistakes in the connection. Be sure to connect the test lead to the measurement point first, and then press the START switch.

#### NOTE

If you set LINE BRK (AUTO) to OFF and PROBE to EncLiv or EncNeu, the TOS3200 does not perform earthing checks. See p. 86 for details.

### Blinking UP <= LOW indication

If the lower reference is set to a value greater than or equal to the upper reference in the LOWER ON condition, “UP <= LOW” will appear at the upper right of the screen to indicate that the setting is invalid.

## Setup Items of AUTO2/2 (Common to All Steps)

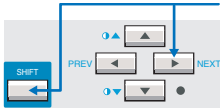

Press the NEXT (SHIFT+▶) key to display the program edit screen 2/2 (AUTO2/2).  
On AUTO2/2, set the items common to all steps.

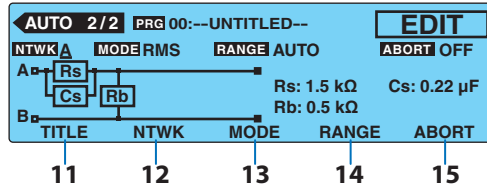

Item	Description	Panel operation
11 TITLE	Selects the program name.	F1 key
	Name Up to 12 of the characters shown in Table 3-1 on page 37 can be entered.	Rotary knob
12 NTWK	Selects the measurement network.	F2 key
	A (For IEC 60990) (1.5 kΩ // 0.22 μF) + 500 Ω	
	B (For IEC 60990) (1.5 kΩ // 0.22 μF) + 500 Ω // (10 kΩ + 22 nF)	
	B1*1 (For IEC 60065) (1.5 kΩ // 0.22 μF) + 500 Ω // (10 kΩ + 22 nF)	
	C (For IEC 60990) (1.5 kΩ // 0.22 μF) + 500 Ω // (10 kΩ + (20 kΩ + 6.2 nF) // 9.1 nF)	SHIFT+F2 key
	D 1 kΩ	
	E 1 kΩ // (10 kΩ + 11.225 nF + 579 Ω)	
	F 1.5 kΩ // 0.15 μF	
G 2 kΩ		
13 MODE	Selects the current measurement mode.	F3 key
	RMS RMS measurement	
	DC DC measurement	SHIFT+F3 key
	PEAK Peak measurement	
14 RANGE	Selects the measurement range.	F4 key
	AUTO Automatically switches the range according to the measured value.	
	FIX Fixes the range. The measurement range is determined by the upper reference, measurement network (NTWK), and current measurement mode (MODE) settings. See Table 6-2.	SHIFT+F4 key
15 ABORT	Selects the operation if a FAIL judgment occurs while a program test is in progress.	F5 key
	OFF Executes the next step even if a FAIL judgment occurs.	
	ON Aborts the program test when a FAIL judgment occurs.	SHIFT+F5 key

\*1 Measures voltage U1 between the measurement network reference points.

See 114

Table 6-2 Determination of the fixed range

Measurement range	MODE	TC measurement				PCC measurement
		Upper reference				Upper reference
		NTWK A, B, B1, C	NTWK D, E	NTWK F	NTWK G	
Range 1	DC, RMS	30 μA to 600 μA	30 μA to 300 μA	30 μA to 200 μA	30 μA to 150 μA	30 μA to 600 μA
	PEAK	50 μA to 850 μA	50 μA to 424 μA	50 μA to 282 μA	50 μA to 212 μA	50 μA to 850 μA
Range 2	DC, RMS	601 μA to 6.00 mA	301 μA to 3.00 mA	201 μA to 2.00 mA	151 μA to 1.50 mA	601 μA to 6.00 mA
	PEAK	851 μA to 8.50 mA	425 μA to 4.24 mA	283 μA to 2.82 mA	213 μA to 2.12 mA	851 μA to 8.50 mA
Range 3	DC, RMS	6.01 mA to 30.0 mA	3.01 mA to 30.0 mA	2.01 mA to 20.0 mA	1.51 mA to 15.0 mA	6.01 mA to 30.0 mA
	PEAK	8.51 mA to 90.0 mA	4.25 mA to 45.0 mA	2.83 mA to 30.0 mA	2.13 mA to 22.5 mA	8.51 mA to 90.0 mA



# Sequence Program Editing Procedure

This section describes the setup procedure of test conditions using an example in which the TC measurement (between the enclosure and earth) is performed and then the PCC measurement is performed by removing the test lead from the EUT. The detailed settings of this test are shown below.

Items common to all steps	Setting
Program number	01
Program name	TEST-1
Measurement network (NTWK)	B
Current measurement mode (MODE)	RMS
Measurement range (RANGE)	AUTO
Operation for FAIL judgment (ABORT)	Continue (OFF)

Steps specific to each step	Setting	
Step number	00	01
Operation mode	TC measurement	PCC measurement (PCC)
Connection destination of the measurement terminal (PROBE)	ENCPE	—
Polarity of the EUT power line (POL)	Normal phase connection (PNRM)	Normal phase connection (PNRM)
Single fault mode (COND)	Normal status (NORM)	Normal status (NORM)
Interval	Until the START switch is pressed (HOLD)	1 s
Upper reference (UPPER)	0.5 mA	1 mA
Lower reference (LOWER)	35 $\mu$ A	None (OFF)
Test wait time (WAIT)	None (OFF)	None (OFF)
Test time (TIMER)	1 s	1 s

The following procedure assumes that nothing is assigned to program number 01 at start.

## Entering the Edit Screen

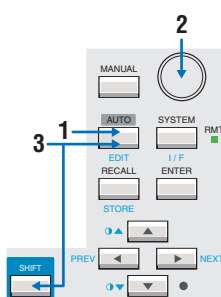

- 1 Press the AUTO key to display AUTO1/2.
- 2 Use the rotary knob to select program number 01.
- 3 Press the EDIT (SHIFT+AUTO) key to display the edit screen.

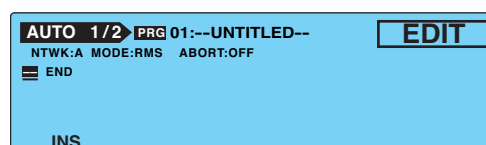

## Setting Items Common to the Program (All Steps)

- 1** Press the NEXT (SHIFT+▶) key to display the AUTO2/2.
- 2** Press the TITLE (F1) key to select the program name.
- 3** Use the rotary knob to select “T,” and press the ▶ key to move the underscore to the right by an item.
- 4** Use the rotary knob to select “E.”  
Repeat similar steps to enter “TEST-1.”  
To delete a character, enter a space.
- 5** After you enter the program name, press the TITLE (F1) key.
- 6** Press the NTWK (SHIFT+F2) key to set NETWK to B.  
Because default settings are used for MODE, RANGE, and ABORT, do not change these items.

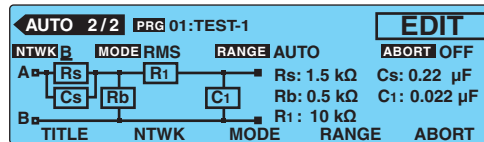

- 7** Press the PREV (SHIFT+◀) key to display the AUTO1/2.

## Setting Step 00

- 1** Press the INS (F1) key to insert step 00.  
Step number 00 is selected.
- 2** Press the ▶ key to move the underscore to the right by a character, and use the rotary knob to select TC.
- 3** Press the ▶ key to move the underscore to the right by four items to select the interval.  
Because default settings are used for the connection destination of the measurement terminal (PROBE), polarity of the EUT power line (POL), and single fault mode (COND), these items are not changed.
- 4** Use the rotary knob to select HOLD.  
By selecting HOLD, step 01 is not executed until you press the START switch again after step 00 is completed. After removing the test lead from the EUT, you can continue the test by pressing the START switch.

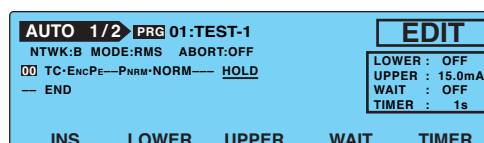

- 5 Press the LOWER ON/OFF (SHIFT+F2) key to set LOWER to ON.**  
By default, LOWER is set to OFF. If LOWER is set to OFF, you will not be able to enter the value even though you can select it using the F3 key or arrow keys.
- 6 Use the rotary knob to set 35 $\mu$ A.**
- 7 Press the UPPER (F3) key to select UPPER.**
- 8 Use the rotary knob to set 500 $\mu$ A.**  
Because default settings are used for WAIT and TIMER, these items are not changed.

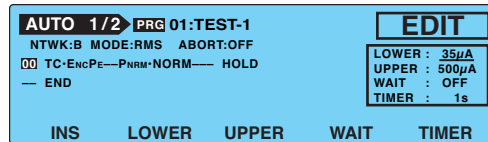

## Setting Step 01

- 1 Press the arrow keys (▲▼◀▶) to select step number 00.**  
The new step is inserted above the selected step.
- 2 Press the INS (F1) key to insert a new step.**  
A copy of step 00 is inserted above step 00.
- 3 Because step number 00 is selected, press the ▼ key to select 01.**
- 4 Press the ▶ key to move the underscore to the right by an item.**
- 5 Use the rotary knob to select PCC.**  
If PCC is selected, the connection destination of the measurement terminal (PROBE) of the adjacent item will become "----."
- 6 Set each item by carrying out the procedure similar to step 00.**

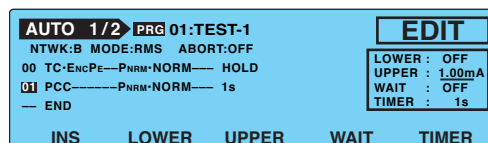

## Exiting from the Edit Screen

- After you are done entering the settings, press the AUTO key.**  
The setup screen closes, and the screen displays "READY."

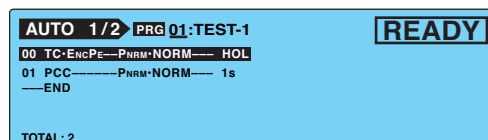

# Setting Additional Test Conditions

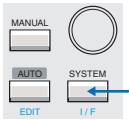

You can set the following functions in the system setup screen (SYSTEM1/5) in addition to the program test conditions.

- Maximum value hold function of the measured current (MEAS MODE)
- Hold time of the PASS judgment (PASS HOLD)
- Measured current conversion display (CONV)
- Buzzer volume (BUZ VOL)
- Power supply to the EUT during the interval time (LINE BRK (AUTO))

SYSTEM1 / 5				
MEAS MODE	: <u>NORM</u>	BUZ VOL (PASS)	:	3
PASS HOLD	: 2.0s	BUZ VOL (FAIL)	:	3
CONV	: OFF	CONTRAST	:	5
SELV	: OFF	LINE BRK(AUTO)	:	ON
MEAS	PASS	CONV	SELV	<NEXT>

## Maximum Value Hold Function of the Measured Current (MEAS MODE)

This function holds and displays the maximum value measured during the test period. The maximum value is held for a single test. The held value is cleared when the test is completed.

See p. 49

The maximum measured value is not held during the test wait time.

- 1** Select the MEAS MODE on SYSTEM1/5.
- 2** Use the rotary knob to select the NORM or MAX.

NORM	Normal measurement (not hold the maximum value)
MAX	Hold the maximum value.

## Hold Time of the PASS Judgment (PASS HOLD)

See p. 91

The test result data can be saved to the memory when the total judgment is displayed after the program test is completed.

If the total judgment is FAIL, the screen will show the FAIL result until you press the STOP switch. Therefore, you can save the data during this period.

See p. 116

On the contrary, the display time when the total judgment is PASS is 2.0 s (default value). Thus, you must save the test result data during this period. If you want to make sure to save the data for PASS judgments, set the display time of the PASS judgment result (PASS HOLD) to HOLD.

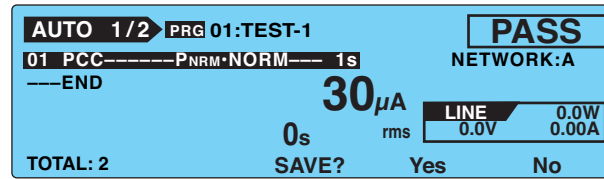

- 1 Select the **PASS HOLD** on **SYSTEM1/5**.
- 2 Use the rotary knob to select the **PASS HOLD** time.

Time	Selectable range: 0.2 s to 10.0 s
HOLD	Hold until the STOP switch is pressed.

**NOTE**

The PASS HOLD time setting of the program test is valid only when the program test is complete. The PASS judgment display for each step depends on the interval time setting.

## Measured Current Conversion Display (CONV)

6

Program Test

The TOS3200 has a function called CONV that converts the measured current by the ratio between the preset CONV voltage and the measured value of the line voltage applied to the EUT AC inlet.

For example, if the line voltage is 100.0 V and you set the preset CONV voltage to 106.0 V, the TOS3200 displays values equal to 106% of the measured currents.

- 1 Select the **CONV** on **SYSTEM1/5**.
- 2 Use the rotary knob to set the voltage.

Voltage	Selectable range: 80.0 V to 300.0 V
OFF	Disable the conversion display.

## Buzzer Volume (BUZ VOL)

You can set the buzzer volume for PASS or FAIL judgments.

- 1 Select the **BUZ VOL** on **SYSTEM1/5**.  
Select the BUZ VOL (PASS) to set the buzzer volume for PASS judgments, or select the BUZ VOL (FAIL) to set the buzzer volume for FAIL judgments.
- 2 Use the rotary knob to set the buzzer volume (0 to 10).  
You can hear the buzzer volume by pressing the BUZ CHK (SHIFT+F5) key when BUZ VOL (PASS) or BUZ VOL (FAIL) is selected.

## Power supply to the EUT during the interval time (LINE BRK (AUTO))

See p. 75

Sets whether or not to supply power to the EUT during program test interval time.

On SYSTEM1/5, press the LINE BRK (AUTO; SHIFT+F4) to select ON or OFF.

ON	Does not supply power to the EUT during the interval time
OFF	Supplies power to the EUT during the interval time

**NOTE**

- Even if you set LINE BRK (AUTO) to OFF, when the EUT power supply switches from a positive phase connection to a negative phase connection between steps, the TOS3200 does not supply power to the EUT. The only way that you can switch the connection is by shutting off the power supply.
- If you set LINE BRK (AUTO) to OFF and PROBE to EncLiv or EncNeu, the TOS3200 does not perform earthing checks. See p. 79 for details.

## Starting the Test



Electric shock may occur. Do not touch the tip of the lead while using the test lead.

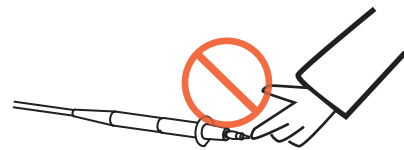

## Starting the test

- 1 Check that the TOS3200 is connected correctly to the EUT.
- 2 On AUTO1/2 with “READY” displayed, press the START switch.

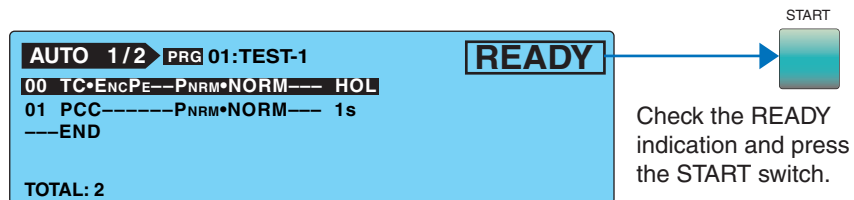

## When a test starts

**NOTE**

If LINE BRK (AUTO) is set to ON, the DANGER lamp and the LINE ON LED do not illuminate during the interval time.

See p. 86

The DANGER lamp illuminates.

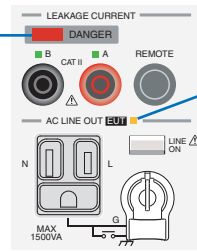

The power line to the EUT is turned on, and this LED illuminates.

### In steps in which WAIT is set to ON

See p. 49

The status changes to WAIT, and the test wait time starts counting down. When the test wait time reaches 0 s, the status changes to TEST, and the test of that step actually starts.

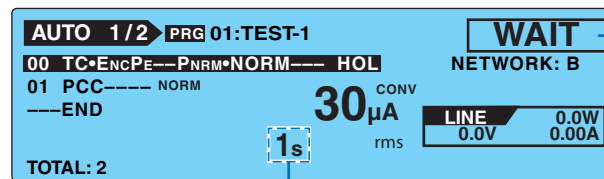

Indicates the test wait status.

Counts down the test wait time.

### In steps in which WAIT is set to OFF

The status changes to TEST, and the test of that step actually starts.

The step that is being executed is highlighted.

Indicates that the measured current is indicated after a conversion.

· SYSTEM1/5 > CONV

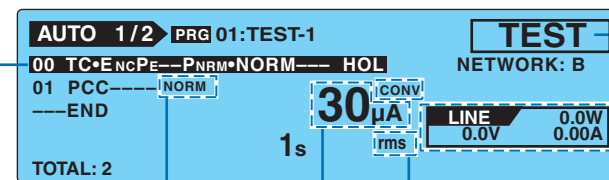

Indicates the test-in-progress status.

Displays the voltage, current, and power of the power line applied to the AC inlet for the EUT.

Measured current

Current measurement mode (RMS/DC/PEAK)

Indicates whether the measured current is shown using the normal display (NORM) or maximum value display (MAX).

· SYSTEM1/5 > MEAS MODE

### During the interval

The judgment result of the previous step is displayed, and the interval time is count down. When the interval time reaches 0 s, the next step is executed.

If the interval time is set to HOLD, the next step will not start until you press the START switch.

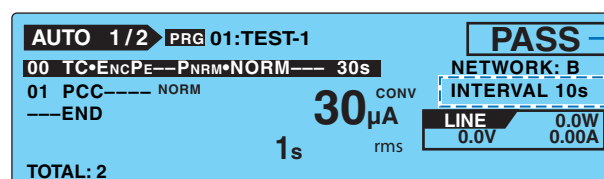

Indicates the test result of the previous step.

Displays a countdown of the interval time. HOLD is displayed if set to hold.

## When a test starts (Cont'd)

### The measured value is blinking

See p. 80

If the measured value exceeds the measurement range specified by AUTO or FIX, the measured value will blink. See Table 6-2.

### CONV is displayed

See p. 120

If the current conversion display function is enabled and the power is not applied to the AC inlet for the EUT, "CONV" will be displayed. The conversion display function is invalid in this condition.

If you are supplying the EUT power from an external source (not from the TOS3200) in the TC measurement between two enclosures, turn the current conversion display function off.

- SYSTEM1/5>CONV

## Unable to Start the Test

### READY is not displayed

You will not be able to start test in the following conditions.

- When AUTO2/2 is displayed.
- When the STOP switch is pressed (includes the condition in which the STOP signal is being applied to the SIGNAL I/O connector).
- When the power line of the EUT is turned on.

See p. 94

See p. 42

### PROTECTION is blinking

See p. 124

If "PROTECTION" is blinking on the screen, the TOS3200 is in the protection status. You will not be able to start the test in this status. Eliminate the cause of the protection status, and then start the test. For details, see "Protection Function."

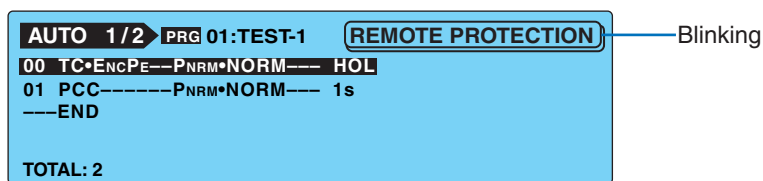

### PASS or FAIL is displayed

You cannot start test while the judgment result is displayed. Press the STOP switch to set the TOS3200 to READY status.



# Stopping the Test

## Aborting the Test

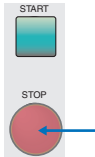

Press the STOP switch.

## When the Test Ends

The program test will stop in any of the conditions below.

- a. When the execution of all steps has been completed.
- b. If U-FAIL, L-FAIL, or CONTACT FAIL occurs (when ABORT is ON).
- c. When you press the STOP switch.

When the program test stops, the DANGER lamp will turn off, and the power line to the EUT will be turned off.

If the test stops in the case of condition a or b above, the total judgment result will be displayed on the screen.

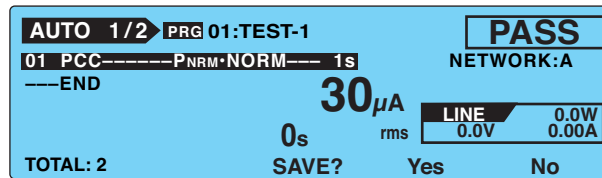

## Program Test Judgment

In a program test, the measured value is judged for each step, and the result is displayed. When all steps are completed, the total judgment of all steps is made.

Table 6-3 Operation when the step is completed or the program test is completed

Operation	PASS	L-FAIL	U-FAIL	CONTACT FAIL
Display	Displays "PASS" on the screen.	Displays "↓FAIL" on the screen.	Displays "↑FAIL" on the screen.	Displays "↓FAIL" on the screen.
Buzzer (only when the program test is completed)	Sounds for 0.2 s. <sup>*1</sup>	Sounds until FAIL is cleared.		
SIGNAL I/O connector	Outputs the pass signal for the time specified by PASS HOLD.	Outputs the L-FAIL signal until FAIL is cleared.	Outputs the U-FAIL signal until FAIL is cleared.	Outputs the L-FAIL and U-FAIL signals until FAIL is cleared.

\*1 The duration of the buzzer for a PASS judgment is fixed to 0.2 s. It does not depend on the PASS HOLD time.

## Program Test Judgment (Cont'd)

### Judgment for each step

See p. 48

Judgment is performed in the same manner as the single test. For details, see “Judgment System.”

The judgment result of each step is displayed on the screen during the interval and also delivered as a signal from the SIGNAL I/O connector. The buzzer does not sound.

### Total judgment

When the program test is complete, a total judgment of all steps is displayed. If the judgment of all steps is the same, the total judgment is also the same. If various judgments are mixed, the judgment with the highest precedence becomes the total judgment. See the following example.

Step	Judgment of each step	
	Program 00	Program 01
00	PASS	PASS
01	PASS	CONTACT FAIL
02	PASS	U-FAIL
03	PASS	PASS
04	PASS	L-FAIL
05	PASS	PASS
Total judgment		
	PASS	U-FAIL

Order of precedence	Judgment
1	U-FAIL
2	L-FAIL
3	CONTACT FAIL
4	PASS

### ABORT setting and FAIL judgment

If ABORT is set to OFF in the example of program 01 above, the test will be executed to step 05, and the total judgment will be U-FAIL.

If ABORT is set to ON, CONTACT FAIL occurs in step 01, and the program test will stop at this point. The total judgment will be CONTACT FAIL, and the test results up to step 01 can be stored.

## Storing the Test Result

See p. 91

The storage function is assigned to a function key while the judgment result is displayed. For details, see “Storing the Test Results.”

## Releasing the Judgment Result

Press the STOP switch to set the TOS3200 to READY status.

# Storing the Test Results

You can store up to 50 program test results. The storage function is assigned to a function key while the judgment result (PASS or FAIL) is displayed.

- 1 Press the Yes (F4) key on the judgment result screen to display the AUTO TEST DATA screen.

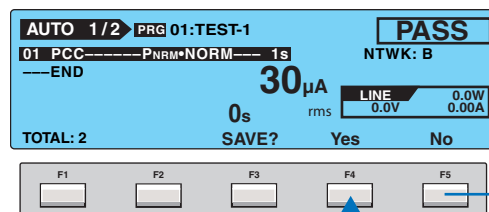

Does not save the test results.  
Skips to step 4.

- 2 Press the arrow keys (▲▼◀▶) to select the desired memory number.

If you select a memory number in which a test result is already saved, the saved information is displayed.

Program number: Program name year/month/day hour:minute

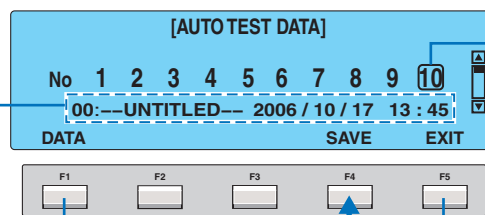

Move the box using the arrow keys to select the number.

Displays the test data of the selected memory number.

Aborts the save operation.

You can check the existing data before overwriting the existing data.

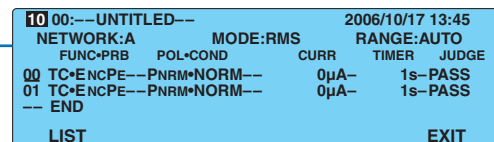

Return to the memory selection screen.

- 3 Press the SAVE (F4) key.  
The saved information is displayed.  
Press the DATA (F1) key to check the stored data.

- 4 Press the EXIT (F5) key.  
The data save screen closes, and the TOS3200 changes to the READY status.

# Displaying the Test Results

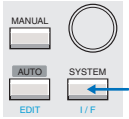

You can display the stored test results from the system setup screen 4/5 (SYSTEM4/5).

- 1 Press the **SYSTEM** key to display **SYSTEM1/5**.
- 2 Press the **<NEXT>** (F5) key three times to display **SYSTEM4/5**.

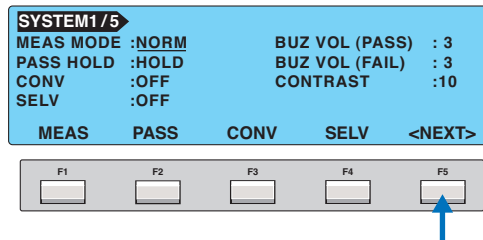

- 3 Press the arrow keys (**▲▼◀▶**) to select the desired memory number.

If you select a memory number in which a test result is already saved, the saved information is displayed.

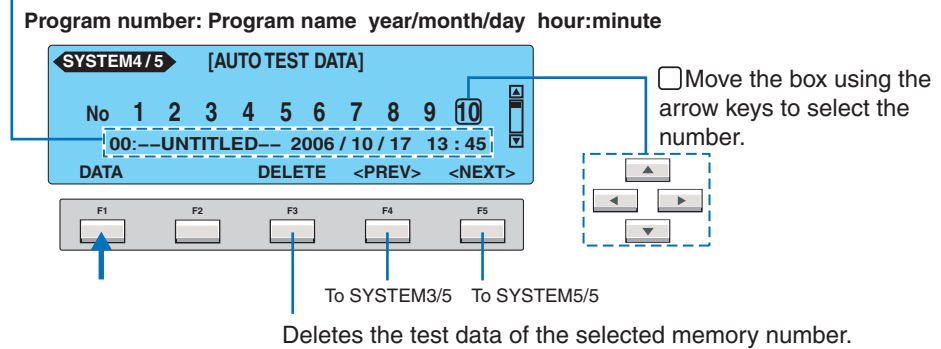

- 4 Press the **DATA** (F1) key.  
The stored test results are displayed.

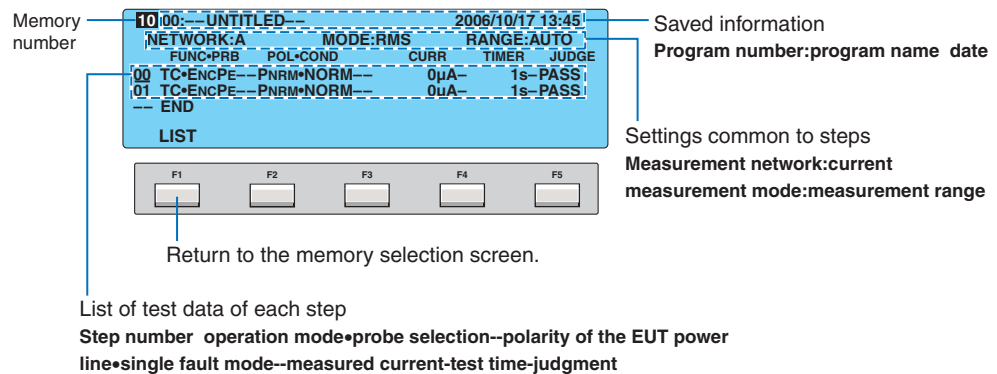

To return to the current measurement, press the **AUTO** key.

## Deleting the Stored Data

Select the memory number you want to delete in step 3 above, and press the **DELETE** (F3) key.



# 7

---

## External Control

This chapter describes how to start the test externally and how to recall panel memories and sequence programs using the SIGNAL I/O connector.

# SIGNAL I/O Connector



**Possible electric shock. Turn off all equipment before connecting or disconnecting cables.**

The SIGNAL I/O connector is the D-sub 25-pin connector on the rear panel.

The connector is used to control the starting and stopping of the test or monitor the TOS3200 status.

- Connector on the TOS3200  
Omron Corp. XM3B-2522 D-SUB 25-pin female connector, Screw M2.6 x 0.45
- Complies connector (plug)  
D-sub 25-pin male (with fix screw M2.6)

To prevent operation errors due to noise, use a shielded D-sub 25-pin connector and a cable of length less than or equal to 3 m.

For information on how to obtain the consumable parts, contact your Kikusui agent or distributor.

For details on how to use the tools, read the catalog by Omron.

- Wire and tool that are necessary to make the connection

Wire	Single wire: $\varnothing 0.32$ mm (AWG28) to $\varnothing 0.65$ mm (AWG22)
	Twisted wire: $0.32$ mm <sup>2</sup> (AWG22) to $0.08$ mm <sup>2</sup> (AWG28)
Wire stripper	A wire stripper that matches the wires listed above

## SIGNAL I/O Specifications

### Input signal

Low-active control input

- High-level input voltage: 11 V to 15 V
- Low-level input voltage: 0 V to 4 V
- Low-level input current: -5 mA maximum
- Input time width: 5 ms minimum

### Output signal

Open drain output

- Output withstand voltage: 30 Vdc
- Output saturation voltage: Approx. 0.7 V (25 °C)
- Maximum output current: 400 mA (TOTAL)

Table 7-1 SIGNAL I/O connector pin arrangement

Pin No.	Signal name	I/O	Description	
1	PM0	I	LSB	2-digit BCD low-active input Signal input pins for selecting the panel memory or program This selection signal is latched on the rising edge of the strobe signal to recall the panel memory or program.
2	PM1	I	–	
3	PM2	I	–	
4	PM3	I	–	
5	PM4	I	–	
6	PM5	I	–	
7	PM6	I	–	
8	PM7	I	MSB	
9	STB	I	Strobe signal input terminal of the panel memory or program	
10	MANU/AUTO	I	Selects single test or program test. (high: single test, low: program test)	
11	STEP_END	O	Output at the end of each step during a program test.	
12	CYCLE_END	O	Output at the end of the last step during a program test.	
13	COM	–	Circuit common	
14	LINE_ON	O	On while power is supplied from AC LINE OUT to the EUT.	
15	TEST	O	On while the test is in progress (excluding the test wait time and interval period).	
16	PASS	O	On for at least 0.2 s (PASS HOLD time) when judgment is PASS. (On continuously if the PASS HOLD time is set to HOLD.)	
17	U-FAIL	O	Continuously on if the judgment is U-FAIL or CONTACT FAIL.	
18	L-FAIL	O	Continuously on if the judgment is L-FAIL or CONTACT FAIL.	
19	READY	O	On during the READY status.	
20	PROTECTION	O	On when a protection is activated.	
21	START	I	Start signal input pin.	
22	STOP	I	Stop signal input pin.	
23	ENABLE	I	Enable signal input pin of the start signal.	
24	+24 V	O	+24-V internal power supply output terminal (maximum output current: 100 mA)	
25	COM	–	Circuit common	

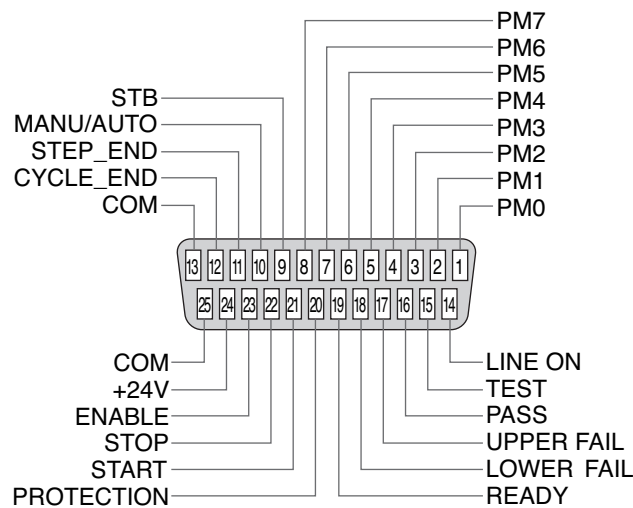

Possible damage to internal circuit. Do not short the +24 V of pin number 24 to the chassis or the circuit common.

## Internal Construction

The common for the input signal circuit and output signal circuit is the same. It is pulled up to +12 V. If the input terminal is opened, the input signal circuit will be in the same condition as when a high level signal is applied.

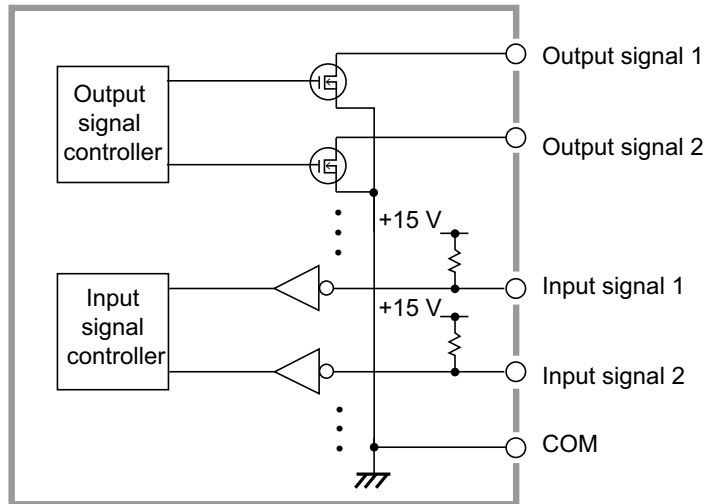
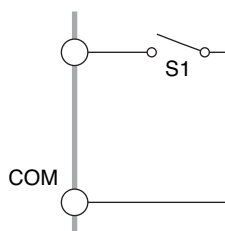

Fig. 7-1 Internal construction of SIGNAL I/O

## Application Examples of Input Signal

### Controlling the TOS3200 using a make contact



The input terminal is set to low level by using a make contact such as a relay or switch.

### Controlling the TOS3200 using a logical device

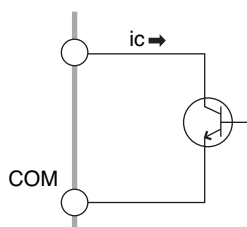

In place of a switch in the example above, a logical device such as a transistor is used.

Construct the circuit so that at least 5 mA of collector current  $i_c$  of the transistor can flow.



## Application Examples of Output Signal

### Driving a relay

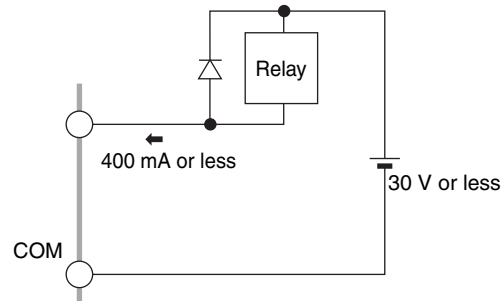

The output signal is used to drive a relay.

### Producing a low level digital signal

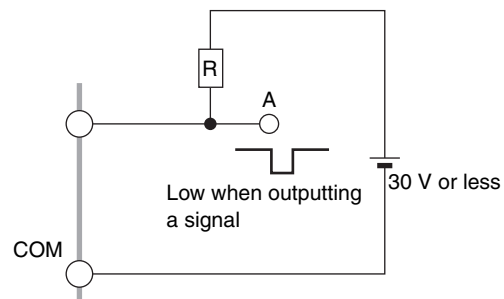

The output signal is used to produce a low level digital signal.

## Starting the Test

To start the test using the SIGNAL I/O connector, set the ENABLE signal to low level. When at least 10 ms passes after the READY signal is set to low level, set the START signal to low level for at least 5 ms. When a valid START signal is detected, the READY signal will be set to high level.

If the ENABLE signal is low level, the start signal of the SIGNAL I/O connector and the START input of the REMOTE terminal will be enabled, and the START switch on the panel will be disabled.

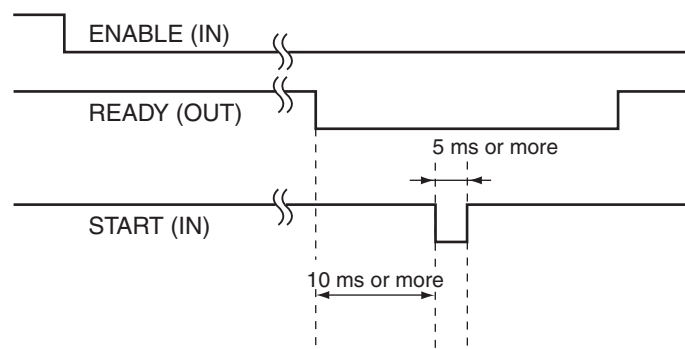

Fig. 7-2 START signal

# Recalling the Panel Memory and Sequence Program

The PM and STB signals are processed at the times shown below. Check that the READY signal is low level.

Table 7-2 shows the relationship between the PM0 to PM7 signals and the panel memory number or program number that is actually recalled.

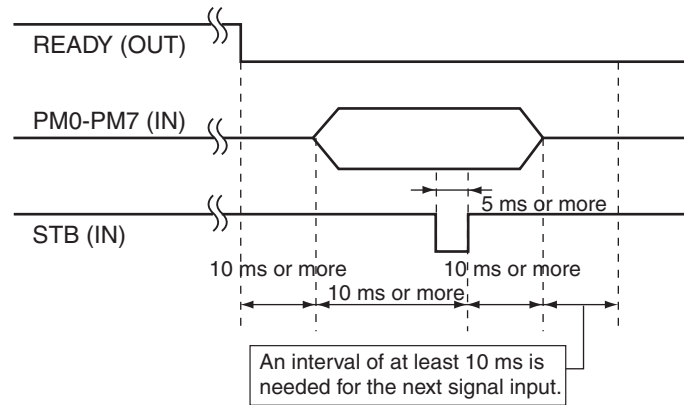

Fig. 7-3 Strobe signal

Table 7-2 Panel memory and program selection

MSD				LSD				MANU/AUTO	Recalled data
PM7	PM6	PM5	PM4	PM3	PM2	PM1	PM0		
H	H	H	H	H	H	H	H	H	Panel memory 00
								L	Program 00
H	H	H	H	H	H	H	L	H	Panel memory 01
								L	Program 01
H	H	H	H	H	H	L	H	H	Panel memory 02
								L	Program 02
⋮									
L	H	H	L	L	H	H	H	H	Panel memory 98
								L	Program 98
L	H	H	L	L	H	H	L	H	Panel memory 99
								L	Program 99



# 8

---

## Maintenance

This chapter covers daily maintenance such as measurement check, how to set the system clock, how to manage periodic calibration, and how to replace the fuse and battery.

# Test Lead Check

Test leads are consumables. Periodically check for tears or breaks in the covering.



**Tears or breaks in the covering can lead to electric shock or fire. If a tear or break is found, stop using it immediately.**

To purchase accessories or options, contact your Kikusui agent or distributor.

# Measurement Check

This function checks the current measurement circuit by running a small current between measurement terminals A and B. Because this test is performed by shorting two test leads, it also checks breaks in the test leads. Use this function as a preliminary inspection before using the TOS3200.

- 1 Attach an alligator clip to the test leads and connect them to the measurement terminals.**
- 2 Short the two test leads.**

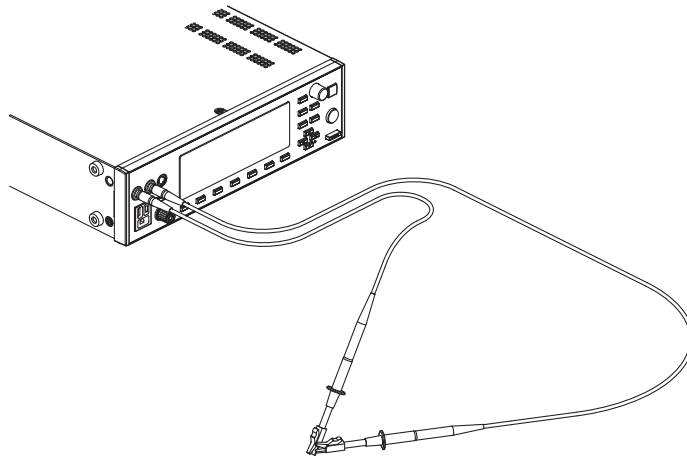
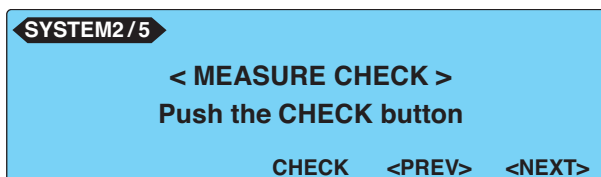
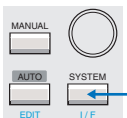

Fig. 8-1 Measurement check connection

- 3 Press the SYSTEM key to display SYSTEM1/5, and press the <NEXT> (F5) key to display SYSTEM2/5.**



- 4 Press the CHECK (F3) key.**

### If the result of the measurement check is OK

The message "Check OK!" will appear. Press the MANUAL or AUTO key and set the test conditions to be executed.

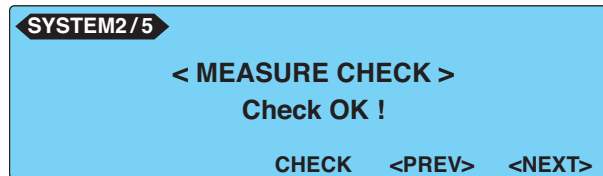

### If the result of the measurement check is NG

The messages "MEASURE PROTECTION" and "Check NG!" will appear, and the TOS3200 will enter the protection status. Press the STOP switch to release the protection status, and return to step 3.

If the result is NG even when you perform the measurement check again, check whether the probe is broken. If the probe is not broken, the TOS3200 needs to be repaired. For repairs, contact your Kikusui agent or distributor.

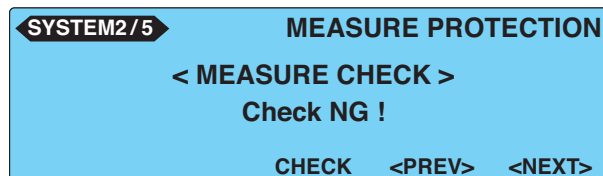

# Time Settings and Calibration Management

The TOS3200 manages the calibration date using the internal system clock. If the preset calibration date is due, the message "CAL DATE EXPIRED" will appear on the screen when the power is turned on.

CAL DATE EXPIRED

Time information will be added to the stored data when you store the test data. If the system clock is not correct, synchronize it to the present time.

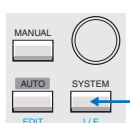

**1** Press the **SYSTEM** key to display **SYSTEM1/5**.

**2** Press the **<NEXT> (F5)** key four times to display **SYSTEM5/5**.

Use the function key or arrow keys to move the underscore to the item you want to change, and use the rotary knob to set the value.

```
SYSTEM5/5
TIME ADJUST :2006/10/18 16:26
CAL. DATE   :2006/10/07
ALARM       :2007/10/18
CAL.PROTECT :ON
ADJUST      ALARM <PREV>
```

The factory default settings are shown below.

TIME ADJUST (system clock):	Standard Japanese time at factory shipment.
CAL. DATE (calibration date):	Calibration date at factory shipment.
ALARM (calibration due date):	One year after CAL. DATE.
CAL. PROTECT (calibration due protection):	OFF (disable protection).

## TIME ADJUST (system clock)

Set the present time in the following format: year/month/day hour:minute. The time that appears is the time when SYSTEM5/5 is displayed.

### NOTE

Enter the present time, and press the ADJUST (F1) key to apply the entered time.

## CAL. DATE (calibration date)

The date is set at the factory or by an authorized service center of Kikusui when calibration is performed. The date is set in the following format: year/month/day. (The user cannot set this date).

## ALARM (calibration due date)

Set the calibration due date in the following format: year/month/day.

## CAL. PROTECT (calibration due protection)

Sets the action taken when the calibration date expires.

If CAL. PROTECT is turned ON, the TOS3200 will display the blinking message “CAL DATE EXPIRED” to notify that the calibration date is due. You cannot use the TOS3200 in this condition.

Press the STOP switch to display SYSTEM5/5, and turn CAL. PROTECT off to continue using the TOS3200.

If the calibration date is due and CAL. PROTECT is turned off, the message “CAL DATE EXPIRED” will appear at power-on. You can continue using the TOS3200 by pressing the STOP switch.

## Calibration

---

The TOS3200 is shipped after carrying out appropriate calibrations. We recommend periodic calibration to maintain the performance over an extended period.

To achieve periodic calibration, set an appropriate calibration due date (ALARM). For calibration, contact your Kikusui agent or distributor.

# Replacing the Fuse

A protection fuse is inserted in the power line to the EUT. Normally, the protection function is activated if 1500 VA or 15.75 A is exceeded, and the power line to the EUT will be cut off. Therefore, this fuse will not blow with normal operation. However, if this fuse blows due to errors in the wiring or aging, it can be replaced.



**Possible electric shock.**

- Remove the power cord from the AC inlet for the EUT before replacing the fuse.
- Use a fuse of shape, rating, and characteristics that conform to the TOS3200. Using a fuse of a different rating or shorting the fuse holder is dangerous.

- 1** Remove the fuse holder on the rear panel by pushing the fuse holder and turning it counterclockwise using a flat-blade screwdriver
- 2** Replace with an appropriate fuse.
- 3** Attach the fuse holder by pressing the fuse holder and turning it to the right.

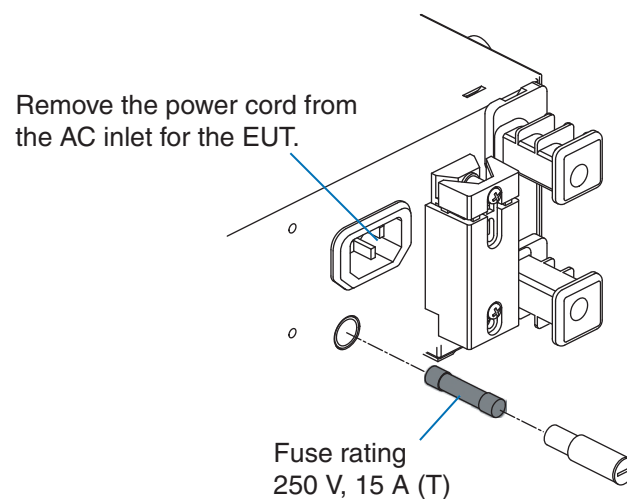

Fig. 8-2 Fuse replacement

# Replacing the Backup Battery

The TOS3200 uses a lithium battery for memory backup.

If the battery power falls low, you will not be able to store measurement conditions and other settings. (The battery life varies depending on the usage environment.) We recommend that you change it once every three years along with the internal inspection and cleaning.

The cover must be opened to replace the backup battery. For replacement, contact your Kikusui agent or distributor.

This product comes with an installed CR Coin Lithium Battery which contains Perchlorate Material. Disposal of this battery may be regulated due to environmental considerations.

See [www.dtsc.ca.gov/hazardouswaste/perchlorate](http://www.dtsc.ca.gov/hazardouswaste/perchlorate)





# 9

---

## Specifications

This chapter gives the specifications and external dimensions.

Unless specified otherwise, the specifications are for the following settings and conditions.

- The warm-up time is 30 minutes.
- rdng: Indicates the read value.
- EUT: Denotes the equipment under test.

## Measurement Items, Measurement Mode, and Measurement Network

Measurement item	TC		TC measurement
	Measurement method		Uses a measurement network representing the human body impedance, measures the voltage drop across the reference resistance, and calculates the TC.
	PROBE setting	ENCPE	Measurement terminal A: Measurement terminal (for connecting to the EUT enclosure) Measurement terminal B: Open
		ENCENC	Measurement terminal A and B: Measurement terminals (for connecting to the EUT enclosure)
		ENCLIV, ENCNEU	Measurement terminal A: Measurement terminal (for connecting to the EUT enclosure) Measurement terminal B: Open
	PCC		Protective conductor current measurement
Measurement method		Measures the voltage drop across a reference resistance that is inserted in the middle of the protective earth wire and measure the PCC.	
Measurement mode (MODE)	METER		Measures the current flowing through measurement terminals A and B or the applied voltage (cannot be measured simultaneously).
	Measurement method	Current measurement	Uses a measurement network representing the human body impedance, measures the voltage drop across the reference resistance, and calculates the current flowing through terminals A and B.
		Voltage measurement	Measures the voltage applied between measurement terminals A and B.
Measurement network (NTWK)	DC		Measures only the DC component by eliminating the AC component.
	RMS		Measures the true rms value.
	PEAK		Measures the waveform peak value.
	Network A (IEC 60990 compliant)		Basic measurement element: $(1.5\text{ k}\Omega // 0.22\text{ }\mu\text{F}) + 500\text{ }\Omega$
	Network B (IEC 60990 compliant)		Basic measurement element: $(1.5\text{ k}\Omega // 0.22\text{ }\mu\text{F}) + 500\text{ }\Omega // (10\text{ k}\Omega + 22\text{ nF})$
	Network B1 (IEC 60990 compliant)		Basic measurement element: $(1.5\text{ k}\Omega // 0.22\text{ }\mu\text{F}) + 500\text{ }\Omega // (10\text{ k}\Omega + (20\text{ k}\Omega + 6.2\text{ nF}) // 9.1\text{ nF})$
	Network C (IEC 60990 compliant)		
	Network D		Basic measurement element: $1\text{ k}\Omega$
	Network E		Basic measurement element: $1\text{ k}\Omega // (10\text{ k}\Omega + 11.225\text{ nF} + 579\text{ }\Omega)$
Network F		Basic measurement element: $1.5\text{ k}\Omega // 0.15\text{ }\mu\text{F}$	
Network G		Basic measurement element: $2\text{ k}\Omega$	
Network constant tolerance		Resistor: $\pm 0.1\%$ , capacitor $0.15\text{ }\mu\text{F}$ : $\pm 2\%$ , others: $\pm 1\%$	

## Current Measurement Section\*1

Display/ resolution i: measure- ment current	$i < 1\text{ mA}$	□□□ $\mu\text{A}$ / $1\text{ }\mu\text{A}$
	$1\text{ mA} \leq i < 10\text{ mA}$	□.□□ $\text{mA}$ / $0.01\text{ mA}$
	$10\text{ mA} \leq i < 100\text{ mA}$	□□.□ $\text{mA}$ / $0.1\text{ mA}$

Measurement range	RANGE1	PCC		DC, RMS: 30 $\mu$ A to 600 $\mu$ A, PEAK: 50 $\mu$ A to 850 $\mu$ A
		Network A, B, B1, and C		
		Network D and E		DC, RMS: 30 $\mu$ A to 300 $\mu$ A, PEAK: 50 $\mu$ A to 424 $\mu$ A
		Network F		DC, RMS: 30 $\mu$ A to 200 $\mu$ A, PEAK: 50 $\mu$ A to 282 $\mu$ A
		Network G		DC, RMS: 30 $\mu$ A to 150 $\mu$ A, PEAK: 50 $\mu$ A to 212 $\mu$ A
	RANGE2	PCC		DC, RMS: 500 $\mu$ A to 6.00 mA, PEAK: 700 $\mu$ A to 8.50 mA
		Network A, B, B1, and C		
		Network D and E		DC, RMS: 250 $\mu$ A to 3.00 mA, PEAK: 350 $\mu$ A to 4.24 mA
		Network F		DC, RMS: 166 $\mu$ A to 2.00 mA, PEAK: 233 $\mu$ A to 2.82 mA
		Network G		DC, RMS: 125 $\mu$ A to 1.50 mA, PEAK: 175 $\mu$ A to 2.12 mA
	RANGE3	PCC		DC, RMS: 5.00 mA to 30.0 mA, PEAK: 7.00 mA to 90.0 mA
		Network A, B, B1, and C		
		Network D and E		DC, RMS: 2.50 mA to 30.0 mA, PEAK: 3.50 mA to 45.0 mA
		Network F		DC, RMS: 1.66 mA to 20.0 mA, PEAK: 2.33 mA to 30.0 mA
		Network G		DC, RMS: 1.25 mA to 15.0 mA, PEAK: 1.75 mA to 22.5 mA
	Range switching		AUTO or FIX selectable. If the measured value exceeds the measurement range of each range, the measured value will blink to warn the user.	
		AUTO	Automatically selects the range according to the measured value.	
		FIX	Automatically sets the range according to the upper reference setting in TC and PCC measurements. Fixed to an arbitrary range in METER measurement.	
Measurement accuracy <sup>*2</sup>	RANGE1	DC		$\pm$ (5.0 % of rdng + 20 $\mu$ A)
		RMS <sup>*3</sup>	15 Hz $\leq$ f $\leq$ 10 kHz	$\pm$ (2.0 % of rdng + 8 $\mu$ A)
			10 kHz < f $\leq$ 1 MHz	$\pm$ (5.0 % of rdng + 10 $\mu$ A)
		PEAK	15 Hz $\leq$ f $\leq$ 1 kHz	$\pm$ (5.0 % of rdng + 10 $\mu$ A)
	1 kHz < f $\leq$ 10 kHz		$\pm$ (5.0 % of rdng + 10 $\mu$ A)	
	RANGE2	DC		$\pm$ (5.0 % of rdng + 50 $\mu$ A)
		RMS <sup>*3</sup>	15 Hz $\leq$ f $\leq$ 10 kHz	$\pm$ (2.0 % of rdng + 20 $\mu$ A)
			10 kHz < f $\leq$ 1 MHz	$\pm$ (5.0 % of rdng + 20 $\mu$ A)
		PEAK	15 Hz $\leq$ f $\leq$ 1 kHz	$\pm$ (2.0 % of rdng + 50 $\mu$ A)
	1 kHz < f $\leq$ 10 kHz		$\pm$ (5.0 % of rdng + 50 $\mu$ A)	
	RANGE3	DC		$\pm$ (5.0 % of rdng + 0.5 mA)
		RMS <sup>*3</sup>	15 Hz $\leq$ f $\leq$ 10 kHz	$\pm$ (2.0 % of rdng + 0.2 mA)
			10 kHz < f $\leq$ 1 MHz	$\pm$ (5.0 % of rdng + 0.2 mA)
PEAK		15 Hz $\leq$ f $\leq$ 1 kHz	$\pm$ (2.0 % of rdng + 0.5 mA)	
	1 kHz < f $\leq$ 10 kHz	$\pm$ (5.0 % of rdng + 0.5 mA)		
Input resistance			1 M $\Omega$ $\pm$ 1 %	
Input capacitance			< 200 pF	
Common mode rejection ratio			$\leq$ 10 kHz: 60 dB or more. 10 kHz to 1 MHz: 40 dB or more	

\*1 The current measurement may not be stable due to effects such as the power line waveform, and the wiring between the TOS3200 and EUT particularly if the measurement mode is set to PEAK or the measurement network is set to A.

\*2 Based on the accuracy of the built-in voltmeter, each value is converted as a current value which is measured by the Network A, B, B1, C and the PCC measurement.

For the other Network's, each value of the current should be read as follow;

\*Network D, E -----  $\pm$  ( $\square$  % of rdng +  $\blacksquare$  A) \*the value for " $\blacksquare$ " shall be 1/2 of the specified value.

\*Network F -----  $\pm$  ( $\square$  % of rdng +  $\blacksquare$  A) \*the value for " $\blacksquare$ " shall be 1/3 of the specified value.

\*Network G -----  $\pm$  ( $\square$  % of rdng +  $\blacksquare$  A) \*the value for " $\blacksquare$ " shall be 1/4 of the specified value.

\*3 The accuracy of DC measurement in the RMS mode is the same as the DC mode.

## Judgment Function

Pass/fail judgment		Judgment with respect to the upper and lower current reference		
Judgment method		Window comparator		
Judgment action		Judgment starts after the test wait time elapses. The buzzer volume can be set in the range of 0 (off) to 10 separately for PASS and FAIL. The buzzer is valid only for the total judgment result during a program test.		
Selectable range of LOWER/UPPER	UPPER FAIL	Judgment method	Indicates U-FAIL judgment if a current greater than or equal to the upper reference is detected.	
		Indication	Shows U-FAIL on the display.	
		Buzzer	On	
		SIGNAL I/O	Outputs a U-FAIL signal.	
	LOWER FAIL	Judgment method	Indicates L-FAIL judgment after the timer value elapses if a current less than or equal to the lower reference is detected.	
		Indication	Shows L-FAIL on the display.	
		Buzzer	On	
		SIGNAL I/O	Outputs an L-FAIL signal.	
	PASS	Judgment method	Indicates PASS judgment after the timer value elapses if the test is not a failure.	
		Indication	Shows PASS on the display.	
		Buzzer	On	
		SIGNAL I/O	Outputs a PASS signal.	
	PASS HOLD		The time to hold the PASS judgment can be set to a value between 0.2 s and 10.0 s or HOLD (buzzer is fixed to 0.2 s).	
	Selectable range of LOWER/UPPER	RANGE1	PCC	DC, RMS: 30 $\mu$ A to 600 $\mu$ A, PEAK: 50 $\mu$ A to 850 $\mu$ A
			Network A, B, B1, and C	
			Network D and E	
Network F			DC, RMS: 30 $\mu$ A to 200 $\mu$ A, PEAK: 50 $\mu$ A to 282 $\mu$ A	
Network G			DC, RMS: 30 $\mu$ A to 150 $\mu$ A, PEAK: 50 $\mu$ A to 212 $\mu$ A	
RANGE2		PCC	DC, RMS: 601 $\mu$ A to 6.00 mA, PEAK: 851 $\mu$ A to 8.50 mA	
		Network A, B, B1, and C		
		Network D and E		DC, RMS: 301 $\mu$ A to 3.00 mA, PEAK: 425 $\mu$ A to 4.24 mA
		Network F		DC, RMS: 201 $\mu$ A to 2.00 mA, PEAK: 283 $\mu$ A to 2.82 mA
		Network G		DC, RMS: 151 $\mu$ A to 1.50 mA, PEAK: 213 $\mu$ A to 2.12 mA
RANGE3		PCC	DC, RMS: 6.01 mA to 30.0 mA, PEAK: 8.51 mA to 90.0 mA	
		Network A, B, B1, and C		
		Network D and E		DC, RMS: 3.01 mA to 30.0 mA, PEAK: 4.25 mA to 45.0 mA
		Network F		DC, RMS: 2.01 mA to 20.0 mA, PEAK: 2.83 mA to 30.0 mA
		Network G		DC, RMS: 1.51 mA to 15.0 mA, PEAK: 2.13 mA to 22.5 mA
Judgment accuracy		Conforms to the measurement accuracy. Read rdng as UPPER setting in the measurement accuracy.		

## Voltage Measurement Between A and B

Measurement range	DC	10.00 V to 300.0 V
	RMS	10.00 V to 300.0 V
	PEAK	15.00 V to 430.0 V
Input impedance		Approx. 40 M $\Omega$
Accuracy* <sup>1</sup>		$\pm(3\%$ of rdng + 2 V) The measurement range is fixed to AUTO.
SELV detection		The DANGER lamp will illuminate if the specified SELV is exceeded.
	Selectable range	10 V to 99 V. 1 V steps. Off function available

\*1. If the voltage is measured with terminals A and B open, the measurement will be prone to the effects of induced voltage.

## Timer, Test Function, and Memory

Timer	Test wait time (WAIT)	Selectable range	0 s to 999 s. Set the time until the test actually starts after the test is started.
		Accuracy	$\pm(100$ ppm of setting + 20 ms)
	Test time (TIMER)	Selectable range	1 s to 999 s. Timer off function available
		Accuracy	$\pm(100$ ppm of setting + 20 ms)
Test function	AUTO		Automatically executes the test conditions of up to 100 steps.
	MANU		Separately executes the TCC, PCC, and METER measurements.
Memory	Test conditions	AUTO	Up to 100 test sets containing test conditions up to 100 steps (total number of steps: 500). You can set whether or not to supply power to the EUT during the interval time by using LINE BRK (AUTO)* <sup>1</sup>
		MANU	Stores up to 100 sets of test conditions.
	Test results		Select whether to save the test result while delivering the judgment result at the end of the test.
	AUTO		Stores the test results of up to 50 programs.
	MANU		Stores the test results of up to 50 tests.

\*1. The TOS3200 may not be able to supply power depending on the settings.

## Other Functions

System clock	Records the calibration date and test execution date/time.	
	Recordable date/time	Up to year 2099
	Calibration due date setting	Calibration due date can be set. Displays a warning at power-on if the time limit expires.
	CAL. PROTECT ON	Displays a warning and switches to protection status at power-on if the time limit expires.
	CAL. PROTECT OFF	Displays a warning at power-on if the time limit expires.
Measured value conversion (CONV)		Converts the measured current to a value at the preset supply voltage. Invalid for METER measurements.
	Selectable range	80.0 V to 300.0 V. Off function available
MEASURE MODE		The measured value during the measurement period can be selected as follows:
	NORM	Displays the measured value during the measurement period.
	MAX	Displays the maximum value during the measurement period.
Power supply normal/reverse phase selection (POL)		EUT power setting: Normal phase (NORM) or reverse phase (REVS).
Single fault condition selection (COND)		EUT power status setting: Normal (NORM), neutral power line disconnection (FLTLN), or protective earthing conductor disconnection (FLTEA).
Earthing check		Valid only for TC measurement between the enclosure and power line. Measures the current flowing through terminals and performs an earthing check. Generates CONTACT FAIL if the EUT enclosure is grounded.
MEASURE CHECK		Checks the measurement function between measurement terminals A and B of the TOS3200 and switches to protection status if there is a problem. The check is performed by shorting between terminals A and B.
Protection action		Switches to protection status, stops the power supply to the EUT, and opens measurement terminals A and B under the following conditions.
	RELAY SHORT PROTECTION	If an error is detected in the relay operation.
	CALIBRATION DATA PROTECTION	If an error is found in the calibration data.
	OVER LOAD PROTECTION	If the current supplied to the EUT exceeds 15.75 A or if the power exceeds 1500 VA.
	MEASURE PROTECTION	If a failure is detected in the measurement check.
	BACKUP PROTECTION	If an error is found in the backup data.
	OVER RANGE PROTECTION	If the maximum value of the measurement range is exceeded.
	CAL PROTECTION	If the calibration time limit elapses.
	REMOTE PROTECTION	If the REMOTE connector of the front panel is connected or removed or if the ENABLE signal of the SIGNAL I/O connector changes.
Supply voltage measurement AC LINE (EUT)	Measurement range	80.0 V to 250.0 V
	Resolution	0.1 V
	Accuracy	$\pm(3\% \text{ of rdng} + 1 \text{ V})$
Supply current measurement AC LINE (EUT)	Measurement range	0.1 A to 15.00 A
	Resolution	0.01 A
	Accuracy	$\pm(5\% \text{ of rdng} + 30 \text{ mA})$
Power measurement (Effective power)	Measurement range	10 W to 1500 W
	Accuracy*1	$\pm(5\% \text{ of rdng} + 8 \text{ W})$

\*1. Supply voltage 80 V or more. Load power factor 1.

## Interface

RS232C		D-sub 9-pin connector on the rear panel (conforms to EIA-232-D)			
Data rate		9600 / 19200 / 38400			
GPIB		Complies with IEEE Std.488-1978. SH1, AH1, T6, TE0, L4, LE0, SR1, PP0, DC1, DT0, C0, and E1			
USB		USB Specification 2.0			
REMOTE		6-pin MINIDIN connector on the rear panel Remotely control start/stop by connecting the optional HP21-TOS test probe			
SIGNAL I/O		D-sub 25-pin connector on the rear panel			
1 PM0	I	LSB	LSD	2-digit BCD low-active input Signal input pins for selecting the panel memory or program	
2 PM1	I				
3 PM2	I				
4 PM3	I				
5 PM4	I				MSD
6 PM5	I				
7 PM6	I				
8 PM7	I	MSB			
9 STB	I	Panel memory or program signal input terminal			
10 MANU/AUTO	I	Selects single test or program test. (high: single test, low: program test)			
11 STEP_END	O	Output at the end of each step during a program test.			
12 CYCLE_END	O	Output at the end of the last step during a program test.			
13 COM	–	Circuit common			
14 LINE_ON	O	On while power is supplied from AC LINE OUT to the EUT.			
15 TEST	O	On while the test is in progress (excluding the test wait time and interval period).			
16 PASS	O	On for at least 0.2 s (PASS HOLD time) when judgment is PASS. (On continuously if the PASS HOLD time is set to HOLD.)			
17 U-FAIL	O	Continuously on if the judgment is U-FAIL or CONTACT FAIL.			
18 L-FAIL	O	Continuously on if the judgment is L-FAIL or CONTACT FAIL.			
19 READ	O	On during the READY status.			
20 PROTECTION	O	On when a protection is activated.			
21 START	I	Start signal input pin			
22 STOP	I	Stop signal input pin			
23 ENABLE	I	Enable signal input pin of the start signal.			
24 +24V	O	+24-V internal power supply output terminal (maximum output current: 100 mA)			
25 COM	–	Circuit common			
Input specifications	High-level input voltage	11 V to 15 V		Low active control for all input signals. The input pins are pulled up to +12 V by a resistor.	
	Low-level input voltage	0 V to 4 V			
	Low-level input current	-5 mA maximum			
	Input time width	5 ms minimum			
Output specifications	Output type	Open drain output (4.5 Vdc to 30 Vdc).			
	Output withstand voltage	30 Vdc			
	Output saturation voltage	Approx. 0.7 V (25 °C)			
	Maximum output current	400 mA (total)			

## General

Display		240 x 64 dot LCD	
Backup battery life		3 years or longer (at 25 °C)	
Measurement terminal	Rated voltage	Between terminals A and B.	250 V
		Between the terminal and chassis	250 V
	Rated current		100 mA
	Measurement category		CAT II
	Active terminal display		Displays the active terminals for the measurement using LED lamps.
Environment	Installation location		Indoors, up to 2000 m
	Spec assured range	Temperature	5 °C to 35 °C (+41 °F to +95 °F)
		Humidity	20 %rh to 80 %rh (no condensation)
	Operating range	Temperature	0 °C to 40 °C (+32°F to +104 °F)
		Humidity	20 %rh to 80 %rh (no condensation)
	Storage range	Temperature	-20 °C to 70 °C (-4 °F to +158 °F)
Humidity		0 to 90 %rh (no condensation)	
Power supply	Nominal input rating		100 Vac to 240 Vac, 50/60 Hz
	Input voltage range (allowable voltage range)		85 Vac to 250 Vac
	Power consumption		70 VA maximum
AC LINE (for the EUT)	Nominal input rating		100 Vac to 240 Vac, 50/60 Hz
	Input voltage range (allowable voltage range)		85 Vac to 250 Vac
	Rated output current		1500 VA (the front panel outlet and the AC LINE OUT terminal block on the rear panel cannot be used simultaneously.)
	Rated operating current		15 A (overcurrent protection: approx. 15.75 A)
	Inrush current		70 Apeak maximum (within 20 ms)
Insulation resistance (between AC LINE and chassis and between measurement terminals and chassis)			30 MΩ or more (500 Vdc)
Withstand voltage (between the AC LINE and chassis)			1390 Vac for 2 seconds, 20 mA or less
Earth continuity			25 Aac/0.1 Ω or less
Safety <sup>*1</sup>			Complies with the requirements of the following directives and standards. Low Voltage Directive 2014/35/EU <sup>*2</sup> EN 61010-1 (Class I <sup>*3</sup> , Pollution degree 2 <sup>*4</sup> )
Electromagnetic Compatibility (EMC) <sup>*1,*2</sup>			Complies with the requirements of the following directives and standards. EMC Directive 2014/30/EU EN 61326-1 (Class A <sup>*5</sup> ) EN 55011 (Class A <sup>*5</sup> , Group 1 <sup>*6</sup> ) EN 61000-3-2 EN 61000-3-3 Applicable condition All of the wires and wires connected to the TOS3200 are less than 3 m in length. Using the accessory test leads.
Outline drawing			See "Outline Drawing".
Weight			Approx. 5 kg (Approx. 11.02 lbs)

\*1. Not applicable to custom order models.

\*2. Only on models that have the CE marking on the panel.

\*3. This is a Class I equipment. Be sure to ground this product's protective conductor terminal. The safety of this product is only guaranteed when the product is properly grounded.

\*4. Pollution is addition of foreign matter (solid, liquid or gaseous) that may produce a reduction of dielectric strength or surface resistivity. Pollution Degree 2 assumes that only non-conductive pollution will occur except for an occasional temporary conductivity caused by condensation.

\*5. This is a Class A equipment. This product is intended for use in an industrial environment. This product may cause interference if used in residential areas. Such use must be avoided unless the user takes special measures to reduce electromagnetic emissions to prevent interference to the reception of radio and television broadcasts.

\*6. This is a Group I equipment. This product does not generate and/or use intentionally radio-frequency energy, in the form of electromagnetic radiation, inductive and/or capacitive coupling, for the treatment of material or inspection/analysis purpose.



Accessories	Test lead (TL21-TOS)	1 set (red and black with alligator clip)
	Flat probe (FP01-TOS)	1 set
	Spare fuse	1 pc.
	CD-ROM	1 pc.
	Quick Reference	English: 1pc., Japanese: 1pc.
	Setup guide	1 pc.
	Safety information	1 pc.
	Circuit principle diagram label	1 pc.
	Power cord	2 pcs.

## Outline Drawing

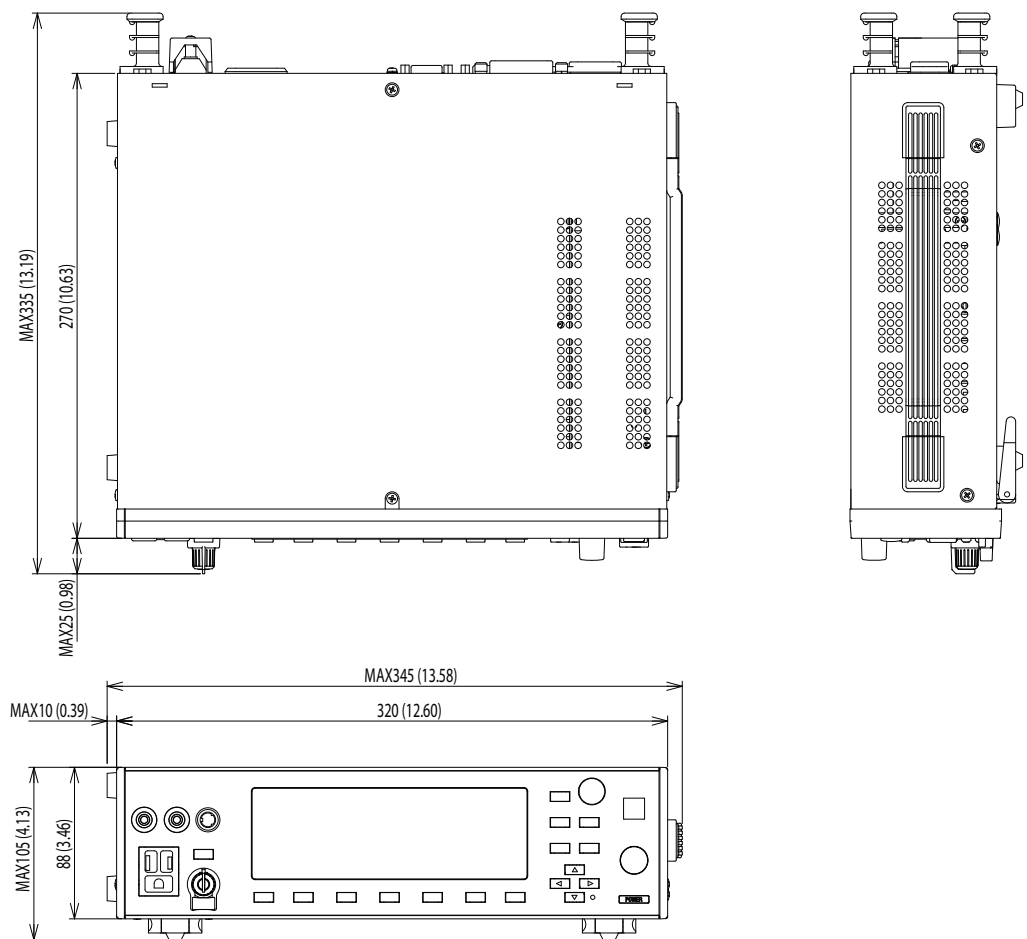

Fig. 9-1 TOS3200 outline drawing

Unit: mm (inch)

## Measurement Network (NTWK)

Network A

Comply with IEC60990 fig.3 U1 measurement

Harmonized standard:  
IEC61010 etc.

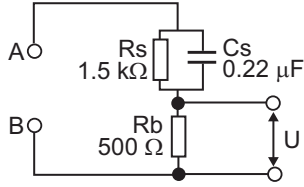

Network D

Applicable standard:

Electrical Appliance and Material Safety Law

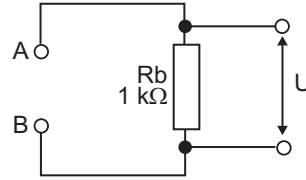

Network B

Comply with IEC60990 fig.4 U2 measurement

Harmonized standard:  
IEC60950  
IEC60335  
IEC60065 U2  
IEC50598  
IEC61010 etc.

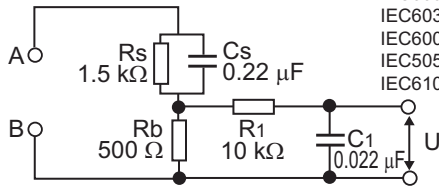

Network E

Applicable standard:

Electrical Appliance and Material Safety Law

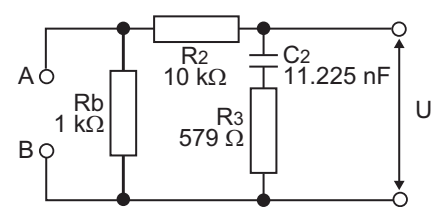

Network B1

Comply with IEC60990 fig.4 U1 measurement

Harmonized standard:  
IEC60065 U1 etc.

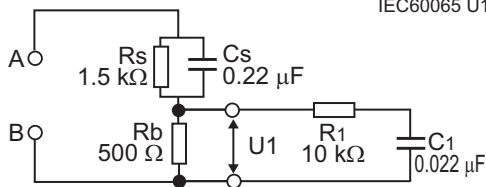

Network F

Applicable standard:

IEC61029 etc.

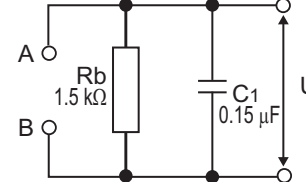

Network C

Comply with IEC60990 fig.5 U3 measurement

Harmonized standard:  
IEC60598 etc.

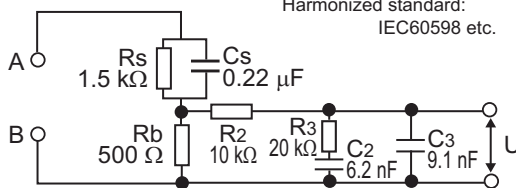

Network G

Applicable standard:

IEC60745 etc.

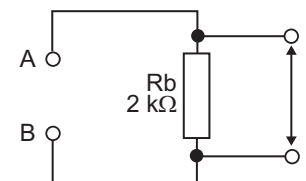

U, U1: Measured voltage between the measurement network reference points



# Appendix

---

- A A List of Default Settings
- B System Settings
- C Protection Function
- D Troubleshooting

# A

# A List of Default Settings

## Initializing the TOS3200

While holding down the SHIFT key, turn on the POWER switch. The TOS3200 displays the firmware version followed by "INITIALIZING!" and starts to initialize.

If you initialize the TOS3200, various settings such as the test conditions and the saved data will be set to the default values indicated below.

**INITIALIZING!**

### Default values

Item	Command	Setting after initialization	Setting after sending the command	
			*RST	*RCL
Operation mode	FUNC	TC	←	Depends on the memory contents.
TC measurement conditions (TC)	PROBE	TC:PROB	←	Depends on the memory contents.
	POL	TC:POL		
	COND	TC:COND		
	LOWER	TC:LIM:LOW		
	LOWER ON/OFF	TC:LIM:LOW:STAT		
	UPPER	TC:LIM:UPP		
	UPPER ON/OFF	TC:LIM:UPP:STAT		
	TIMER	TC:TIM		
	TIMER ON/OFF	TC:TIM:STAT		
	WAIT	TC:WAIT		
	WAIT ON/OFF	TC:WAIT:STAT		
	NTWK	TC:NETW		
	MODE	TC:MODE		
	RANGE	TC:RANG:SEL		
PCC measurement conditions (PCC)	POL	PCC:POL	←	Depends on the memory contents.
	COND	PCC:COND		
	LOWER	PCC:LIM:LOW		
	LOWER ON/OFF	PCC:LIM:LOW:STAT		
	UPPER	PCC:LIM:UPP		
	UPPER ON/OFF	PCC:LIM:UPP:STAT		
	TIMER	PCC:TIM		
	TIMER ON/OFF	PCC:TIM:STAT		
	WAIT	PCC:WAIT		
	WAIT ON/OFF	PCC:WAIT:STAT		
	MODE	PCC:MODE		
	RANGE	PCC:RANGE:SEL		

Item		Command	Setting after initialization	Setting after sending the command	
				*RST	*RCL
Meter mode measurement conditions (METER)	NTWK	CURR:NETW	A	←	Depends on the memory contents.
	MODE	CURR:MODE	RMS		
		VOLT:MODE	RMS		
RANGE	CURR:RANG:SEL	AUTO			
System settings (SYSTEM)	MEAS MODE	SYST:CONF:MMOD	NORM	No change	←
	PASS HOLD	SYST:CONF:PHOL	2.0 s		
	CONV	SYST:CONF:CONV	OFF		
	SELV	SYST:CONF:SELV	OFF		
	BUS VOL (PASS)	SYST:BEEP:VOL:PASS	3		
	BUS VOL(FAIL)	SYST:BEEP:VOL:FAIL	3		
	CONTRAST	DISP:CONT	5		
	LINE BRK (AUTO)	SYST:CONF:LBR	ON		
	TIME ADJUST	SYST:DATE / SYST:TIME	No change <sup>*1</sup>		
	CAL. DATE	–			
	ALARM	–			
	CAL. PROTECT	–			
Interface settings (INTERFACE)	I/F SELECT	–	GPIB	No change	←
	GPIB ADDRESS	–	3		
	BAUDRATE	–	19200		
	DATA BITS	–	8		
	X-FLOW	–	ON		
	STOP BITS	–	1		
	TALK MODE	–	OFF		
	ERR TRACE	SYST:ERR:TRAC	OFF		
Individual test data	–	No saved data	No change	←	
Program test data	–	No saved data			
Panel memory	–	See .			
Sequence program	–	No registered steps			
Trigger source (during remote control)	TRIG:SOUR	IMM	←	←	
Sets the program number (during remote control)	PROG:NAME	-1 <sup>*2</sup>	←	←	
Power supply line	OUTP:LINE	OFF	←	←	
Display during testing	DISP:SIZE	NORM	No change	←	
Voltage display in expanded display mode	DISP:UXV	OFF	No change	←	

\*1. The factory default settings are shown below.

TIME ADJUST: Standard Japanese time at factory shipment.

CAL. DATE: Calibration date at factory shipment.

ALARM: One year after CAL. DATE.

\*2. Aborts the program operation.

## Default Values of the Panel Memory

There are a total of 100 panel memories. By factory default, memory numbers 00 to 50 contain preset test conditions of TC measurement conforming to various safety standards. These memory numbers can be overwritten as with 51 to 99.

The contents of the panel memory will be reset to default values if the TOS3200 is initialized.

### Default values of memory numbers 00 to 50

The default values for items other than those indicated in this table are set to the value of item B in below table.

No.	Memory name	NTWK	PROBE	POL	COND	MODE	UPPER	Notes
-----	-------------	------	-------	-----	------	------	-------	-------

#### IEC 60990 Methods of measurement of TC and PCC

00	IEC60990(1)	B	ENCPE	NORM	NORM	RMS	0.5 mA	Response limit
01	IEC60990(2)	C					10 mA	Let-go limit
02	IEC60990(3)	A					30.0 mA	Electric burn limit

#### IEC 60950-1 Information technology equipment - Safety - Part 1: General requirements

03	IEC60950(1)	B	ENCPE	NORM	NORM	RMS	0.25 mA	All equipment
04	IEC60950(2)		REVS					
05	IEC60950(3)		ENCNEU	-	-		0.5 mA	Class 0I equipment, hand-held equipment
06	IEC60950(4)		ENCLIV					
07	IEC60950(5)		ENCNEU				0.75 mA	Class I equipment, hand-held equipment
08	IEC60950(6)		ENCLIV					
09	IEC60950(7)		ENCNEU				1 mA	Class 0I equipment, other equipment
10	IEC60950(8)		ENCLIV					
11	IEC60950(9)		ENCNEU				3.5 mA	Class I equipment, other equipment
12	IEC60950(10)		ENCLIV					

#### IEC 60335-1 Household and similar electrical appliances - Safety - Part 1: General requirements

13	IEC60335(1)	B	ENCLIV	-	-	RMS	0.5 mA	Class 0 and 0I equipment
14	IEC60335(2)		ENCNEU					
15	IEC60335(3)		ENCLIV				0.75 mA	Class I equipment, hand-held equipment
16	IEC60335(4)		ENCNEU					
17	IEC60335(5)		ENCLIV				3.5 mA	Class I equipment, motor equipment
18	IEC60335(6)		ENCNEU					
19	IEC60335(7)		ENCLIV				0.25 mA	Class II equipment
20	IEC60335(8)		ENCNEU					

#### IEC 60065 Audio, video and similar electronic apparatus - Safety requirements

21	IEC60065(1)	B	EncEnc	NORM	NORM	PEAK	0.7 mA	
22	IEC60065(2)		ENCLIV	-	-			
23	IEC60065(3)		ENCNEU					
24	IEC60065(4)	B1*1	EncEnc	NORM	NORM	PEAK	70 mA	100 kHz or higher in frequency (electrical burn)
25	IEC60065(5)		ENCLIV	-	-			
26	IEC60065(6)		ENCNEU					
27	IEC60065(7)		EncEnc	NORM	NORM	DC	2 mA	
28	IEC60065(8)		ENCLIV	-	-			
29	IEC60065(9)		ENCNEU					

No.	Memory name	NTWK	PROBE	POL	COND	MODE	UPPER	Notes
-----	-------------	------	-------	-----	------	------	-------	-------

## IEC 60745-1 Hand-held motor-operated electric tools - Safety - Part 1: General requirements

30	IEC60745(1)	G	ENCLIV	-	-	RMS	0.5 mA	Class 0I equipment
31	IEC60745(2)		ENCNEU					
32	IEC60745(3)		ENCLIV				0.75 mA	Class I instrument
33	IEC60745(4)		ENCNEU					
34	IEC60745(5)		ENCLIV				0.25 mA	Class II equipment
35	IEC60745(6)		ENCNEU					

## IEC 60598-1 Luminaries - Part 1: General requirements and tests

36	IEC60598(1)	B	ENCLIV	-	-	RMS	0.5 mA	Class 0 and II equipment
37	IEC60598(2)		ENCNEU					
38	IEC60598(3)	C	ENCLIV				1 mA	Class I equipment and mobile luminaire
39	IEC60598(4)		ENCNEU					

## IEC 61010-1 Safety requirements for electrical equipment for measurement, control, and laboratory use - Part 1: General requirements

40	IEC61010(1)	B	ENCPE	NORM	NORM	RMS	0.5 mA	
41	IEC61010(2)				FLTNEU		3.5 mA	
42	IEC61010(3)				FLTPE		3.5 mA	

## Electrical Appliance and Material Safety Law

43	PSE(1)	D	ENCPE	NORM	NORM	RMS	1 mA	
44	PSE(2)	E						

## IEC 61029-1 Safety of transportable motor-operated electric tools - Part 1: General requirements

45	IEC61029(1)	F	ENCLIV	-	-	RMS	0.5 mA	Class 0I equipment
46	IEC61029(2)		ENCNEU					
47	IEC61029(3)		ENCLIV				0.75 mA	Class I instrument
48	IEC61029(4)		ENCNEU					
49	IEC61029(5)		ENCLIV				0.25 mA	Class II equipment
50	IEC61029(6)		ENCNEU					

\*1. The "A" has been contained to preset for the product equipped with the firmware version of 1.0x.

## Default values of memory numbers 51 to 99

Item A	Setting
Operation mode	TC
NTWK	A
PROBE	ENCPE
POL	NORM
COND	NORM
MODE	RMS
UPPER	30 mA

Item B	Setting
UPPER ON/OFF	ON
LOWER	30 $\mu$ A
LOWER ON/OFF	OFF
TIMER	10 s
TIMER ON/OFF	OFF
WAIT	1 s
WAIT ON/OFF	OFF
RANGE	AUTO

# B System Settings

The system settings consist of the following five screens.

SYSTEM1/5	General settings of the TOS3200
SYSTEM2/5	Measurement check
SYSTEM3/5	Management of the single test result data
SYSTEM4/5	Management of the program test result data
SYSTEM5/5	Time settings and calibration management

You can enter the system setup screen from the 1/2 screen of each operation mode.

To exit from the system setup screen, press the MANUAL or AUTO key to return to the screen of the original operation mode.

## Setup Items of SYSTEM1/5

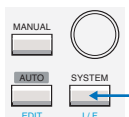



Press the SYSTEM key to display SYSTEM1/5.

On SYSTEM1/5, set the items indicated in the following.

<b>SYSTEM1/5</b>						
1	MEAS MODE	: NORM	BUZ VOL (PASS)	: 3	5	
2	PASS HOLD	: 2.0s	BUZ VOL (FAIL)	: 3	6	
3	CONV	: OFF	CONTRAST	: 5	7	
4	SELV	: OFF	LINE BRK(AUTO)	: ON	8	
	MEAS	PASS	CONV	SELV	<NEXT>	9

Item	Description	Panel operation
1	MEAS MODE	Sets whether to hold the maximum value of the measured values.
	NORM	Normal measurement (not hold the maximum value)
	MAX	Hold the maximum value. Displays the maximum value during the measurement period.
		Rotary knob
2	PASS HOLD	Sets the time to hold the PASS judgment.
	Time	Selectable range: 0.2 s to 10.0 s
	HOLD	Hold until the STOP switch is pressed.
		Rotary knob
3	CONV	Displays the converted measured current based on the specified line voltage. Available in the TC measurement or PCC Measurement Mode.
	Voltage	Selectable range: 80.0 V to 300.0 V
	OFF	Disable the conversion display.
		Rotary knob



Item	Description	Panel operation
4 SELV	Sets the safety extra low voltage (SELV). If the voltage between measurement terminals A and B exceeds the SELV, the DANGER lamp will illuminate. Available in the Meter Mode.	F4 key
	Voltage    Selectable range: 10 V to 99 V OFF        Disable the SELV check function.	Rotary knob
5 BUZ VOL (PASS) <sup>*1</sup>	Sets the buzzer volume for PASS judgments.	SHIFT+F1 key (Rotary knob)
	Level        Selectable range: 0 to 10	
6 BUZ VOL (FAIL) <sup>*1</sup>	Sets the buzzer volume for U-FAIL and L-FAIL judgments and CONTACT FAIL	SHIFT+F2 key (Rotary knob)
	Level        Selectable range: 0 to 10	
7 CONTRAST	Sets the screen brightness. You can also use the  (SHIFT+▲) or  (SHIFT+▼) key.	SHIFT+F3 key (Rotary knob)
	Level        Selectable range: 0 to 10	
8 LINE BRK (AUTO)	Sets whether or not to supply power to the EUT during program test interval time.	SHIFT+F4 key (rotary knob)
	ON            Does not supply power to the EUT during the interval time	
	OFF           Supplies power to the EUT during the interval time <sup>*2</sup>	
9 <NEXT>	Displays SYSTEM2/5.	F5 key

\*1 You can hear the buzzer volume by pressing the BUZ CHK (SHIFT+F5) key when BUZ VOL (PASS) or BUZ VOL (FAIL) is selected.

\*2 Even if you set LINE BRK (AUTO) to OFF, the TOS3200 may not supply power to the EUT depending on the step combination.

## Setup Items of SYSTEM2/5

See p. 100

On SYSTEM1/5, press the <NEXT> (F5) key to display SYSTEM2/5.

You can execute a measurement check on SYSTEM2/5. The measurement check verifies the operation of the current measurement circuit of the TOS3200. For a description of the measurement check execution, see "Measurement Check."

Appx

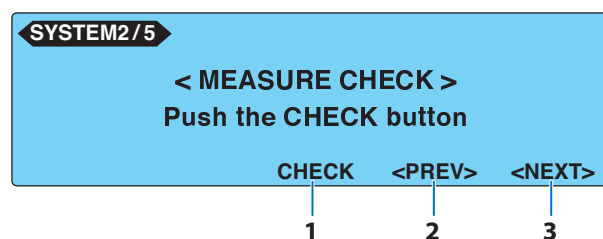

Item	Description	Panel operation
1 CHECK	Executes the measurement check.	F3 key
2 <PREV>	Displays SYSTEM1/5	F4 key
3 <NEXT>	Displays SYSTEM3/5.	F5 key

## Setup Items of SYSTEM3/5

On SYSTEM2/5, press the <NEXT> (F5) key to display SYSTEM3/5.  
 You can display or delete the stored single test data on SYSTEM3/5.

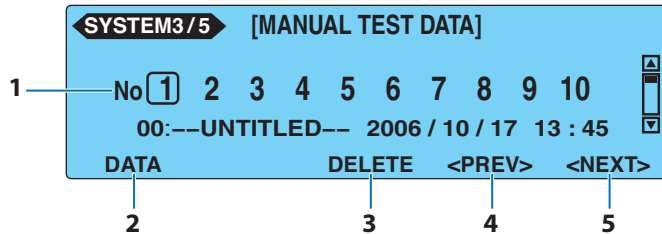

Item	Description	Panel operation
1 No	Specifies the memory number (1 to 50) at which the single test data is stored. If you specify a memory number for the stored data, the saved information will be displayed below the memory number.	◀, ▶, ▲, or ▼ key
2 DATA	Displays the contents of the specified test data. LIST Returns to the single test data list (SYSTEM3/5).	F1 key F1 key
3 DELETE	Deletes the contents of the specified test data. Displayed only when a memory number containing test data is specified.	F3 key
4 <PREV>	Displays SYSTEM2/5.	F4 key
5 <NEXT>	Displays SYSTEM4/5.	F5 key

## Setup Items of SYSTEM4/5

On SYSTEM3/5, press the <NEXT> (F5) key to display SYSTEM4/5.  
 You can display or delete the stored program test data on SYSTEM4/5.

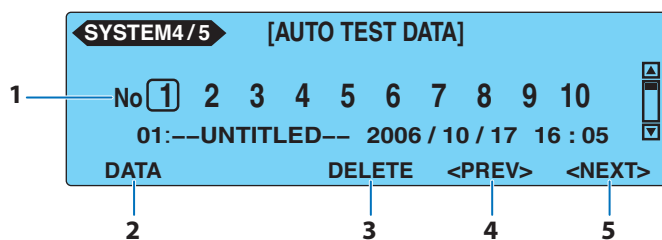

Item	Description	Panel operation
1 No	Specifies the memory number (1 to 50) at which the program test data is stored. If you specify a memory number for the stored data, the saved information will be displayed below the memory number.	◀, ▶, ▲, or ▼ key
2 DATA	Displays the contents of the specified test data. LIST Returns to the program test data list (SYSTEM4/5).	F1 key F1 key

Item	Description	Panel operation
3 DELETE	Deletes the contents of the specified test data. Displayed only when a memory number containing test data is specified.	F3 key
4 <PREV>	Displays SYSTEM3/5.	F4 key
5 <NEXT>	Displays SYSTEM5/5.	F5 key

## Setup Items of SYSTEM5/5

On SYSTEM4/5, press the <NEXT> (F5) key to display SYSTEM5/5.

On SYSTEM5/5, set the items indicated in below.

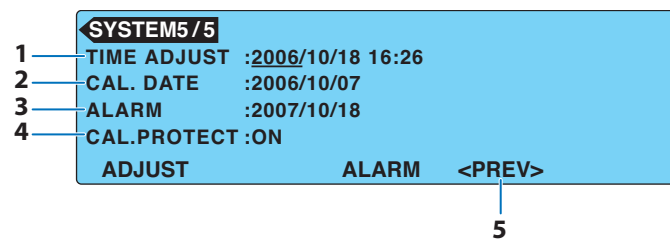

Item	Description	Panel operation
1 TIME ADJUST	Sets the system clock. Enter the present time, and press the ADJUST (F1) key to apply the entered time.	F1 key
	Time Sets the present time. Year/month/day hour:minute	Rotary knob
2 CAL. DATE	Set to the date when calibration service was performed. (You cannot set this date.) Year/month/day	
3 ALARM	Sets the calibration time limit.	F3 key
	Time Sets the next calibration date. Year/month/day	Rotary knob
4 CAL. PROTECT	Sets the action taken when the calibration time limit expires.	
	ON The message "CAL PROTECTION" will blink when the power is turned on if the calibration date is due. You will not be able to use the TOS3200 if "CAL PROTECTION" is displayed. Press the STOP switch to display SYSTEM5/5, and turn CAL. PROTECT off to continue using the TOS3200.	SHIFT+F4 key
OFF	The message "CAL DATE EXPIRED" will appear when the power is turned on if the calibration date is due. Press the STOP switch to continue using the TOS3200.	
5 <PREV>	Displays SYSTEM4/5.	F4 key



# Protection Function

If one or more events occur on the eight items indicated in , the protection circuit will be activated. This is called the protection status, and you cannot use the TOS3200 in this state.

In the protection status, a blinking message will appear on the screen. Release the protection status according to the instructions given in . If the TOS3200 enters the protection status due to multiple events, the protection message of the highest precedence will be displayed.

Order of precedence	Blinking message	Description	Remedy
1	RELAY SHORT PROTECTION	Relay operation error. The operation error may be due to noise.	You can release the protection by pressing the STOP switch. However, if this protection occurs often, the TOS3200 needs to be repaired.
2	CALIBRATION DATA PROTECTION	Error in the calibration data.	This protection cannot be released. The TOS3200 needs to be repaired.
3	OVER LOAD PROTECTION	A current greater than or equal to 15.75 A flowed through the power line to the EUT, or the power is exceeding 1500 VA. The power consumption by the connected EUT is too large, or the EUT power line is shorted.	Disconnect the EUT, and press the STOP switch to release the protection.
4	MEASURE PROTECTION	The result of the measurement check (SYSTEM 2/5) is in error.	If you perform the check again and there is no error, you can continue to use the TOS3200. If the error persists, check that the probe is not broken. If the probe is not broken, the TOS3200 needs to be repaired.
5	BACKUP PROTECTION	Backup error data error.	You can release the protection by pressing the STOP switch. However, some settings may be reset to their default values.
6	OVER RANGE PROTECTION	The measurement range is exceeded.	Press the STOP switch to release the protection.
7	CAL PROTECTION	The calibration data specified by SYSTEM5/5 > ALARM has been surpassed. This protection will occur if SYSTEM5/5 > CAL. PROTECT is set to ON.	Set CAL. PROTECT to OFF and press the STOP switch to release the protection.
8	REMOTE PROTECTION	The enable signal of the SIGNAL I/O connector or that of the REMOTE connector changed.	Press the STOP switch to release the protection.

# D Troubleshooting

This section introduces troubleshooting measures. Typical symptoms are listed. Check whether any of the symptoms below apply to your case. In some cases, the problem can be solved quite easily.

 p. 116

If none of the items apply to your case, we recommend that you initialize the TOS3200 to factory default settings. If the remedy does not solve the problem, contact your Kikusui agent or distributor.

## The power does not turn on.

Symptom	Check and Remedy	 Page
The TOS3200 does not operate when the POWER switch is turned on.	<ul style="list-style-type: none"> <li>Is the power cord is connected?</li> <li>Is the power cord connected to the AC inlet for the TOS3200 and not the AC inlet for the EUT?</li> </ul>	25
Power is not supplied to the EUT even if the LINE ON key is pressed.	Is the power input fuse for the EUT blown?	104
	Is power being supplied to the AC inlet for the EUT?	26

## The panel does not work properly.

Symptom	Check and Remedy	 Page
It is difficult to view the screen.	Is the screen contrast set low?	34
The test does not start even if the START switch is pressed.	Is a probe connected to the REMOTE connector? Only the START switch of the probe is valid if the probe is connected.	47
	Is a stop signal being applied to the SIGNAL I/O connector? The START switch on the panel is invalid if you are controlling the TOS3200 through the SIGNAL I/O connector.	97
	Is the message "PROTECTION" blinking on the screen? The TOS3200 is in the protection status. See "Protection Function".	124
	Is the EUT power line turned on? Press the LINE ON key to turn the line off.	42
	You cannot start the test from the TC2/2 or PCC2/2 screen.	63
	You cannot start the test while the panel memory is being accessed or while a sequence program is being edited.	32 76
	Is the message "UP<=LOW" shown at the upper right of the screen? Settings in which the lower reference is greater than the upper reference are invalid.	–
Panel key operations are not accepted.	Is the message "KEY LOCK" shown at the lower right of the screen? Release the key lock.	34
	Is the RMT LED illuminated? The TOS3200 is operating via the RS232C, GPIB, or USB interface. To control the TOS3200 from the panel, press the LOCAL key to enable local mode.	–
The TOS3200 does not switch to local mode even when I press the LOCAL key.	Was a local lockout (LLO) command sent via the communication interface? Use a communication command to clear the LLO command.	*1

\*1 See the Communication Interface Manual.

### Unable to make correct measurements.

Symptom	Check and Remedy	See Page
The measured values are not correct.	<ul style="list-style-type: none"> <li>Is the test lead connected to the correct terminal? Connect a test lead to the measurement terminal for which the LED is illuminated.</li> </ul>	43
	<ul style="list-style-type: none"> <li>Is the measurement network that you are using correct? Use the measurement network required by the standard to make the measurement.</li> </ul>	–
	<ul style="list-style-type: none"> <li>Is the CONV function turned on? Turn CONV off to determine the measured values at the power voltage supplied to the EUT.</li> </ul>	59
	<ul style="list-style-type: none"> <li>Is WAIT turned OFF? If you do not measure the EUT data at startup, turn WAIT on and set an appropriate time.</li> </ul>	49
	<ul style="list-style-type: none"> <li>If the power cord of the EUT is a two-prong cord with a ground wire, is the ground line connected to a ground terminal?</li> </ul>	40
	<ul style="list-style-type: none"> <li>Is the EUT connected to both the plug on the front panel and the terminal block on the rear panel?</li> </ul>	–
The measured values are not updated.	<ul style="list-style-type: none"> <li>Is the TOS3200 set to hold the measured value? If MEAS MODE is set to MAX in Meter Mode, press the MAXCLR (F4) key to clear the held, measured value.</li> </ul>	70
Unable to save the test data when the judgment is PASS.	<ul style="list-style-type: none"> <li>Is the PASS hold time too short?</li> </ul>	58
The test does not stop.	<ul style="list-style-type: none"> <li>Is the timer turned off? The specified test time is not enabled. Turn the timer on.</li> </ul>	–
The program test does not stop.	<ul style="list-style-type: none"> <li>Is there a step in which the timer is turned off? The program will advance to the next step only if U-FAIL or CONTACT FAIL occurs for steps whose timer is turned off. Turn the timer on.</li> </ul>	–
The test does not stop even if the judgment is FAIL in the middle of a program test.	<ul style="list-style-type: none"> <li>Is ABORT turned off? Turn ABORT on if you want to stop the test on a FAIL judgment at the step level.</li> </ul>	80
The time when the test data was saved is not correct.	<ul style="list-style-type: none"> <li>Is the system clock correct? Set the system clock to the present time.</li> </ul>	102

### Unable to control the TOS3200 remotely through the RS232C.

Symptom	Check and Remedy	See Page
Unable to control the TOS3200 from the PC.	<ul style="list-style-type: none"> <li>Is the talk mode turned on? Turn talk mode off to control the TOS3200 from a PC.</li> </ul>	*1
	<ul style="list-style-type: none"> <li>Are you using a cross cable?</li> </ul>	*1

\*1 See the Communication Interface Manual.

# INDEX

<b>A</b>	
ABORT .....	90
AC LINE OUT .....	40
accessories .....	22
AUTO1/2 .....	76
AUTO2/2 .....	80
<b>B</b>	
BACKUP PROTECTION .....	124
BUZ VOL .....	59, 85, 121
<b>C</b>	
CAL DATE EXPIRED .....	102
CAL PROTECTION .....	124
CALIBRATION DATA PROTECTION .....	124
calibration time limit .....	102
CAT II .....	5
Check .....	100
CONV .....	59, 85, 120
Converted Display of the Measured Current .....	59, 85
<b>D</b>	
data, deletion of .....	66, 92
<b>E</b>	
Earthing check .....	51
EUT, checking the operation of .....	42
<b>F</b>	
firmware version .....	2, 27
Flat Probe .....	46
FP01-TOS .....	46
Fuse .....	104
<b>H</b>	
HP21-TOS .....	47
<b>I</b>	
initialization .....	116
interval .....	75, 87
<b>J</b>	
judgment .....	48
Judgment for each step .....	90
<b>K</b>	
KEY LOCK .....	34
<b>L</b>	
L-FAIL .....	48
LINE BRK (AUTO) .....	86, 121
LINE ON key .....	42
List of Default Settings .....	116
Lithium battery for backup .....	104
<b>M</b>	
MEAS MODE .....	58, 84, 120
MEASURE CHECK .....	121
MEASURE PROTECTION .....	124
measurement category II .....	5
Measurement Check .....	100, 121
measurement network .....	114
meter mode measurement screen 1/2 .....	70
meter mode measurement screen 2/2 .....	71
METER1/2 .....	70
METER2/2 .....	71
multi outlet .....	19, 41
<b>N</b>	
NTWK .....	114
<b>O</b>	
options .....	18
OT01-TOS .....	41
outline drawing .....	113, 114
OVER LOAD PROTECTION .....	124
OVER RANGE PROTECTION .....	124
<b>P</b>	
palm .....	46
Panel memory .....	36, 118
PASS .....	48
PASS HOLD .....	58, 84, 120
PCC measurement screen 1/2 .....	54
PCC measurement screen 2/2 .....	57
PCC1/2 .....	54
PCC2/2 .....	57
POWER .....	27
power cord .....	25
power, turning on .....	27
Program edit screen 2/2 .....	80
program test screen 1/2 .....	76
PROTECTION .....	124
protection status .....	124
<b>R</b>	
rack mount adapter .....	18
RELAY SHORT PROTECTION .....	124
REMOTE PROTECTION .....	124
<b>S</b>	
safety extra low voltage .....	71, 121
screen brightness .....	34
SELV .....	71, 121
sequence program .....	74
SIGNAL I/O connector .....	94
single test .....	35
Stand .....	24
Starting the Test .....	60, 86
Step .....	74
Default values .....	76
Deleting .....	77
insertion .....	76, 77

Stopping the Test .....	64, 89
system clock .....	102, 123
system setup screen .....	120
SYSTEM1/5 .....	120
SYSTEM2/5 .....	121
SYSTEM3/5 .....	122
SYSTEM4/5 .....	122
SYSTEM5/5 .....	123

## T

TC measurement screen 1/2 .....	50
TC measurement screen 2/2 .....	53
TC1/2 .....	50
TC2/2 .....	53
test leads .....	43, 69
Test Probe .....	18, 47
test results, display of .....	66, 92
test results, storage of .....	65, 91
Test Wait Time .....	49
TL21-TOS .....	43, 69
total judgment .....	90
troubleshooting .....	125

## U

U-FAIL .....	48
--------------	----

## V

version .....	2
---------------	---

## W

warm-up time .....	106
--------------------	-----





If you find any misplaced or missing pages in the manuals, they will be replaced. If the manual gets lost or soiled, a new copy can be provided for a fee. In either case, please contact your Kikusui agent or distributor. At that time, inform your agent or distributor of the "Part No." written on the front cover of this manual.

Every effort has been made to ensure the accuracy of this manual. However, if you have any questions or find any errors or omissions, please contact your Kikusui agent or distributor.

After you have finished reading this manual, store it so that you can use it for reference at any time.

## **KIKUSUI ELECTRONICS CORP.**

---

1-1-3 Higashiyamata, Tsuzuki-ku, Yokohama,  
224-0023, Japan

Phone: +81-45-482-6353

Facsimile: +81-45-482-6261

**[www.kikusui.co.jp/en/](http://www.kikusui.co.jp/en/)**

