

OPERATION MANUAL

MULTI-OUTPUT REGULATED
DC POWER SUPPLY
PMR Series

PMR18-2.5DU

PMR35-1.2DU

PMR18-1.3TR

PMR25-1TR

PMR24-1QU

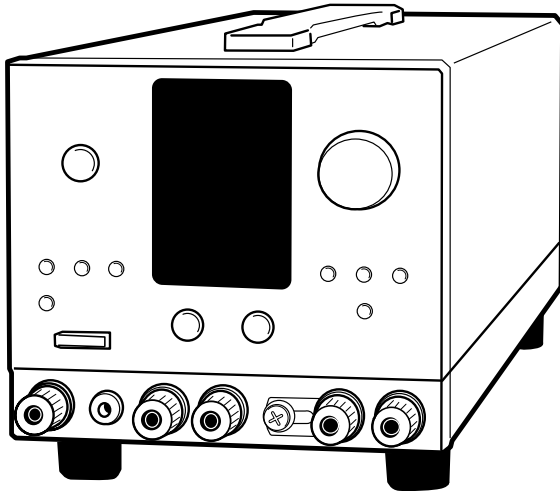

Use of Operation Manual

Please read through and understand this Operation Manual before operating the product. After reading, always keep the manual nearby so that you may refer to it as needed. When moving the product to another location, be sure to bring the manual as well.

If you find any incorrectly arranged or missing pages in this manual, they will be replaced. If the manual gets lost or soiled, a new copy can be provided for a fee. In either case, please contact Kikusui distributor/agent, and provide the "Part No." given on the cover.

This manual has been prepared with the utmost care; however, if you have any questions, or note any errors or omissions, please contact Kikusui distributor/agent.

Microsoft and Visual Basic are registered trademarks of Microsoft Corp. of the U.S.A.

NI-488.2 is registered trademarks of National Instruments Corp. of the U.S.A.

The contents of this Operation Manual may not be reproduced, in whole or in part, without the prior consent of the copyright holder.

The specifications of this product and the contents of this Operation Manual are subject to change without prior notice.

Power Requirements of this Product

Power requirements of this product have been changed and the relevant sections of the Operation Manual should be revised accordingly. (Revision should be applied to items indicated by a check mark)

Input voltage

The input voltage of this product is _____ VAC,
and the voltage range is _____ to _____ VAC.

Use the product within this range only.

Input fuse

The rating of this product's input fuse is

_____ A, _____ VAC, and _____ .



- To avoid electrical shock, always disconnect the AC power cord or turn off the switch on the switchboard before attempting to check or replace the fuse.
 - Use a fuse element having a shape, rating, and characteristics suitable for this product. The use of a fuse with a different rating or one that short circuits the fuse holder may result in fire, electric shock, or irreparable damage.
-

Safety Symbols

For the safe use and safe maintenance of this product, the following symbols are used throughout this manual and on the product. Understand the meanings of the symbols and observe the instructions they indicate (the choice of symbols used depends on the products).



Indicates that a high voltage (over 1,000 V) is used here. Touching the part causes a possibly fatal electric shock. If physical contact is required by your work, start work only after you make sure that no voltage is output here.

DANGER

Indicates an imminently hazardous situation which, if ignored, will result in death or serious injury.

 **WARNING**

Indicates a potentially hazardous situation which, if ignored, could result in death or serious injury.

 **CAUTION**

Indicates a potentially hazardous situation which, if ignored, may result in damage to the product and other property.



Shows that the act indicated is prohibited.



Is placed before the sign “DANGER,” “WARNING,” or “CAUTION” to emphasize these. When this symbol is marked on the product, see the relevant sections in this manual.



Indicates a protective conductor terminal.



Indicates a chassis(frame) terminal.

Safety Precautions

The following safety precautions must be observed to avoid fire hazard, electrical shock, accidents, and other failures. Keep them in mind and make sure that all of them are observed properly.



Users

- This product must be used only by qualified personnel who understand the contents of this operation manual.
- If it is handled by disqualified personnel, personal injury may result. Be sure to handle it under supervision of qualified personnel (those who have electrical knowledge.)



Purposes of use

- Do not use the product for purposes other than those described in the operation manual.

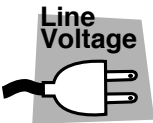

Input power

- Use the product with the specified input power voltage.
- For applying power, use the AC power cord provided. Note that the provided power cord is not use with some products that can switch among different input power voltages or use 100 V and 200 V without switching between them. In such a case, use an appropriate power cord. For details, see the relevant page of this operation manual.



Fuse

- With products with a fuse holder on the exterior surface, the fuse can be replaced with a new one. When replacing a fuse, use the one which has appropriate shape, ratings, and specifications.



Cover

- There are parts inside the product which may cause physical hazards. Do not remove the external cover.

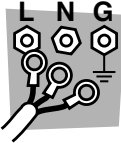

Installation

- When installing products be sure to observe "Precautions for Installation" described in this manual.
- To avoid electrical shock, connect the protective ground terminal to electrical ground (safety ground).
- When applying power to the products from a switchboard, be sure work is performed by a qualified and licensed electrician or is conducted under the direction of such a person.
- When installing products with casters, be sure to lock the casters.



Relocation

- Turn off the power switch and then disconnect all cables when relocating the product.
- Use two or more persons when relocating the product which weights more than 20 kg. The weight of the products can be found on the rear panel of the product and/or in this operation manual.
- Use extra precautions such as using more people when relocating into or out of present locations including inclines or steps. Also handle carefully when relocating tall products as they can fall over easily.
- Be sure the operation manual be included when the product is relocated.



Operation

- Check that the AC input voltage setting and the fuse rating are satisfied and that there is no abnormality on the surface of the AC power cord. Be sure to unplug the AC power cord or stop applying power before checking.
- If any abnormality or failure is detected in the products, stop using it immediately. Unplug the AC power cord or disconnect the AC power cord from the switchboard. Be careful not to allow the product to be used before it is completely repaired.
- For output wiring or load cables, use connection cables with larger current capacity.
- Do not disassemble or modify the product. If it must be modified, contact Kikusui distributor/agent.



Maintenance and checking

- To avoid electrical shock, be absolutely sure to unplug the AC power cord or stop applying power before performing maintenance or checking.
- Do not remove the cover when performing maintenance or checking.
- To maintain performance and safe operation of the product, it is recommended that periodic maintenance, checking, cleaning, and calibration be performed.



Service

- Internal service is to be done by Kikusui service engineers. If the product must be adjusted or repaired, contact Kikusui distributor/agent.

Contents

Power Requirements of this Product	I
⚠ Safety Symbols	II
⚠ Safety Precautions	III
Preface	P-1
About this manual	P-1
Outline of the PMR series	P-2
Options	P-2
Chapter 1 Setup	1-1
1.1 Checking at unpacking	1-1
1.2 Precautions for installation	1-3
1.3 Precautions for moving	1-5
1.4 Checking input power and the fuse	1-6
1.5 AC power cord connection	1-8
1.6 Grounding	1-10
Chapter 2 Precautions and Preparations for Use	2-1
2.1 Inrush current	2-1
2.2 Anti-polar voltage	2-1
2.3 Load	2-2
2.3.1 When load current has peaks or is pulse-shaped	2-2
2.3.2 When a load generates a reverse current to the power supply	2-3
2.3.3 In case of load with accumulated energy, such as batteries	2-4
2.4 Constant-voltage and constant-current power supplies	2-5
2.5 OHP alarm	2-7
2.6 Output channel number	2-8
2.7 Output terminal cover	2-9
Chapter 3 Operation	3-1
3.1 Turning on the power	3-1
3.2 Basic operations	3-3
3.2.1 Output settings	3-3

3.2.2	Using as a constant-voltage power supply	3-8
3.2.3	Using as a constant-current power supply	3-9
3.3	Load connections	3-10
3.4	Tracking operations	3-12
3.5	Memory function	3-16
3.6	Series operation	3-18
3.6.1	PMR-DU type	3-18
3.6.2	PMR-TR type	3-19
3.6.3	PMR-QU type	3-22
3.7	Functions of the MODE switches	3-24
3.7.1	OUTPUT ON operation during startup (POWER ON)	3-24
3.7.2	LOCK operation	3-25
Chapter 4	Remote Control	4-1
4.1	Analog remote control	4-2
4.1.1	J1 terminal board	4-2
4.1.2	Output voltage control by external voltage	4-6
4.1.3	Output ON/OFF control by external contact	4-12
4.1.4	Recall of Memories 1, 2, and 3 by external contact	4-14
4.2	Digital remote control	4-16
4.2.1	Connecting of the Power Supply Controller and Device messages	4-16
Chapter 5	Components and Functions	5-1
5.1	Front panel	5-1
5.2	Rear panel	5-8
Chapter 6	Maintenance	6-1
6.1	Cleaning	6-1
6.2	Inspection	6-1
6.3	Calibration	6-2
6.3.1	Necessary equipment	6-2
6.3.2	Environment	6-2
6.3.3	Calibration mode	6-3
6.3.4	Calibration procedure	6-4
6.4	Malfunctions and causes	6-11

Chapter 7 Specifications	7-1
7.1 Specifications	7-1
7.2 Dimensional drawings	7-10
Index	I-1

About this manual

This Operation Manual covers the following modes in the PMR series.

- PMR18-2.5DU
- PMR35-1.2DU
- PMR18-1.3TR
- PMR25-1TR
- PMR24-1QU

The contents of this Operation Manual apply to these models. To ease explanation, some sections of the Manual apply to models with the same number of outputs, as follows.

PMR-DU type

Applies to dual output models PMR18-2.5DU and PMR35-1.2DU.

PMR-TR type

Applies to triple output models PMR18-1.3TR and PMR25-1TR.

PMR-QU type

Applies only to quadruple output model PMR24-1QU.

For details on the PIA4800 series Power Supply Controller, see the operation manual of the respective product. For connection to a Power Supply Controller and device messages, refer to the "Connecting & Programming Guide" [Index.html] in the CD-ROM that came with the PIA4800 series.

■ Applicable ROM Version

This Operation Manual applies to the PMR series with ROM Version 2.0x.

Outline of the PMR series

The PMR series is a power supply with multi-output regulated DC that can adjust each output starting with 0 V. Equipped with a dual tracking function, the PMR series can also change positive and negative voltages at the same ratio.

The PMR series has the following features.

- Realizes low-noise, stable output by the series regulator method.
- Enables remote control of each output voltage through the use of an external voltage.
- Compatible with a variety of systems, such as automatic testers, when used together with a power-supply controller in our PIA4800 series, which features USB, GPIB, and RS-232C interfaces.

Options

The following options are offered for incorporation into a rack.

- Rack mount adapter KRA3 (Inch rack, EIA standard)
KRA150 (Millimeter rack, JIS standard)
- Blank panel KBP3-3
BP191(-M) (Inch rack, EIA standard)
BP1H(-M) (Millimeter rack, JIS standard)

 **CAUTION** • Provided with inlets for forced air cooling, the PMR series requires a blank panel with at least one unit width (*1) if it is to be installed on a rack.

*1 JIS: 50 mm; EIA: 44.45 mm

For details, contact Kikusui distributor/agent.

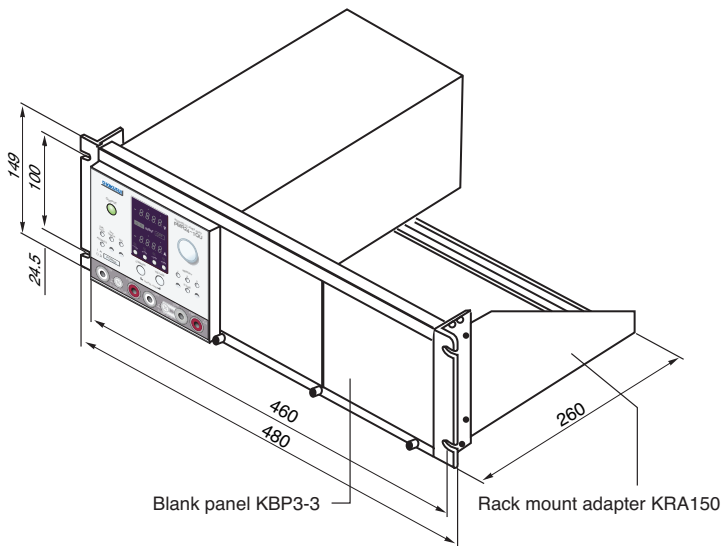
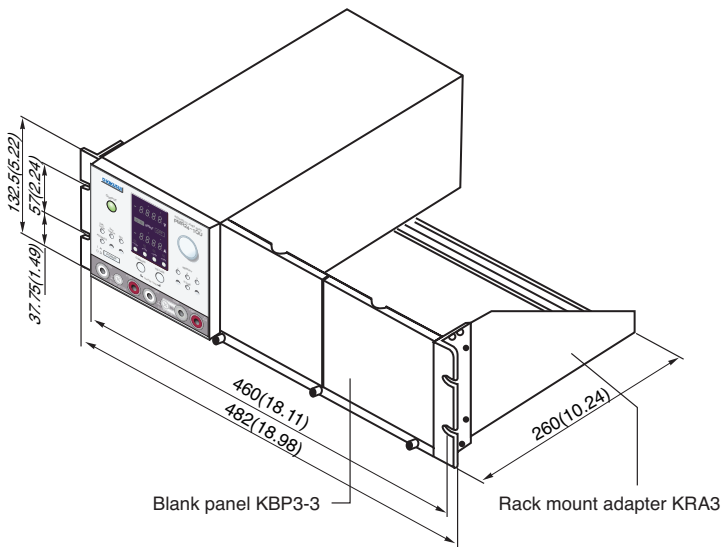

Unit: mm(inch)

Fig. P-1 The PMR series with options for incorporation into a rack

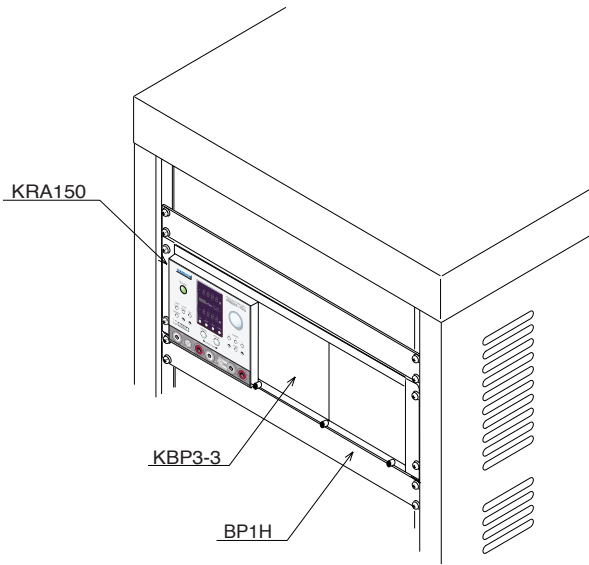

Fig. P-2 The PMR series incorporated into a rack

This chapter explains the preliminary procedure for using the PMR series, starting with unpacking.

1.1 Checking at unpacking

Upon receiving this product, make sure the package contains the necessary accessories and has not been damaged during transportation.

If any part is damaged or missing, contact Kikusui distributor/agent.

NOTE

- Packing materials may be used for transport of the product, so it is recommended that they be retained.
-

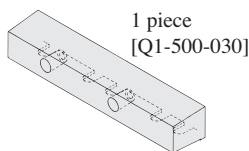

1 piece
[Q1-500-030]



Mounting screws: 2 pieces [M3-001-211]



Washer: 1 piece [Q2-000-001]

Output terminal cover

At the time of delivery, the PMR-DU and PMR-QU types have a cover with screws inserted through it, together with washers.

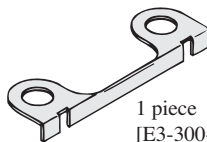

1 piece
[E3-300-029]

Short bar

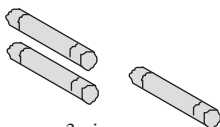

3 pieces
4A(T) [99-02-0020]
2A(T) [99-00-0026]

Fuse

Three fuses are included with the product. One is provided as a reserve in the fuse holder. At the time of delivery, different types of fuses are provided in accordance with the settings of the line voltage range, as follows:

Line voltage range	Inside the fuse holder	Provided separately
90 V–110 V	4 A(T) 1 piece	2 A(T) 2 pieces
106 V–125 V	4 A(T) 1 piece	2 A(T) 2 pieces
180 V–220 V	2 A(T) 1 piece	4 A(T) 2 pieces
211 V–250 V	2 A(T) 1 piece	4 A(T) 2 pieces



1 piece
[84-61-5102]

TP-BUS connector

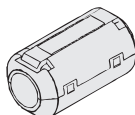

1 piece
[67-90-0080]

TP-BUS core

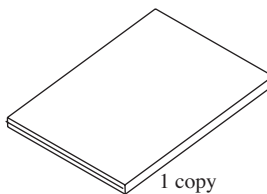

1 copy
[Z1-002-122]

Operation Manual



Rating: 125 V, 10 A
PLUG: NEMA5-15
[85-AA-0004]

or



Rating: 250 V
PLUG: CEE7/7
[85-AA-0005]

or



Rating: 250 V, 10 A
PLUG: GB1002
[85-10-0790]

AC Power cord
(1 pc.)

The power cord that is provided varies depending on the destination for the product at the factory-shipment.

Fig. 1-1 Accessories

1.2 Precautions for installation

Be sure to observe the following precautions when installing the power supply.

■ **Do not use the power supply in a flammable atmosphere.**

To prevent explosion or fire, do not use the power supply near alcohol, thinner, or other combustible materials, or in an atmosphere containing such vapors.

■ **Avoid locations where the power supply is exposed to high temperatures or direct sunlight.**

Do not locate the power supply near a heater or in areas subject to drastic temperature changes.

Operating temperature range: 0°C to +40°C (32°F to 104°F)

Storage temperature range: -10°C to +60°C (14 °F to 140°F)

■ **Avoid humid environments.**

Do not locate the power supply in a high-humidity environment—near a boiler, humidifier, or water supply.

Operating humidity range: 10% to 80% R.H

(no dew condensation is allowed)

Storage humidity range: 90% R.H or less

(no dew condensation is allowed)

Condensation may occur even within the operating humidity range. In that case, do not start using the power supply until the location is completely dry.

■ **Do not place the power supply in a corrosive atmosphere.**

Do not install the power supply in a corrosive atmosphere or one containing sulfuric acid mist or the like. This may cause corrosion of various conductors and imperfect contact with connectors, leading to malfunction and failure, or in the worst case, a fire.

■ **Do not locate the power supply in a dusty environment.**

Dirt and dust in the power supply may cause electrical shock or fire.

■ **Do not use the power supply where ventilation is poor.**

The power supply employs a forced air cooling system. Air is taken in from intake ports located on the power supply's sides and front, and is exhausted from the rear. Prepare sufficient space around the power supply so that the intake ports and exhaust port are always completely unobstructed. Otherwise, heat may accumulate in the power supply, resulting in fire.

■ **Do not place any object on the power supply.**

Particularly a heavy one, as doing so could result in a malfunction.

■ **Do not place the power supply on a tilted surface or in a location subject to vibrations.**

If placed on a non-level surface or in a location subject to vibration, the power supply may fall, resulting in damage and injury.

■ **Do not use the power supply in locations affected by strong magnetic or electric fields.**

Operation in a location subject to magnetic or electric fields may cause the power supply to malfunction, resulting in electrical shock or fire.

■ **Secure adequate space around the power switch.**

Do not place the PMR Series in a location that would result in poor accessibility to the switch. And, do not place objects near the switch that would result in poor accessibility.

1.3 Precautions for moving

When moving or transporting the power supply to an installation site, observe the following precautions.

- **Turn the POWER switch off.**

Moving the power supply with the power on may result in electrical shock or damage.

- **Remove all wirings connected.**

Moving the power supply with cables connected may break the cables or cause the power supply to fall, resulting in injury.

- **For transportation, use the special packing material for the power supply.**

Transport the power supply in its original package to prevent vibration and falls, which may damage the power supply.

If you require packing material, contact Kikusui distributor/agent.

1.4 Checking input power and the fuse

As shown in Fig. 1-2, four line voltage ranges are available for the PMR series. Check the default settings to determine whether the voltage is suitable for your power supply. Use a power fuse appropriate for your line voltage range.

⚠ WARNING • To prevent electric shock, be sure to unplug the AC power cord or turn the switch on the switchboard off before checking or replacing the fuse.

⚠ CAUTION • Make sure that the fuse used conforms to the power supply specifications, including shape, rating, and characteristics. Using a fuse with different rating or short-circuiting, the fuse holder will damage the power supply.

When checking or changing the line voltage range, or when checking or replacing the power fuse, observe the following instructions:

1. Turn the POWER switch off.
2. Unplug the AC power cord from the power supply.
3. Check the input voltage switch at the bottom of the power supply to determine whether it is set at an appropriate voltage for the power supply. To change the setting, follow the instructions on the SWITCH POSITION indicator. (Fig. 1-2)
4. Remove the cover from the fuse holder. (Fig. 1-3)
5. Check the fuse to make sure its rated voltage is within the line voltage range, and that its pre-arcing time-current characteristic is of the time-delay (T) type.
If necessary, replace with an appropriate fuse.
6. Reset the cover of the fuse holder.

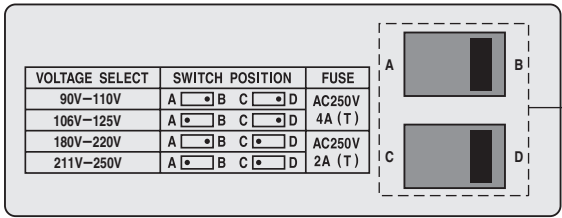

In this figure,
90 V-110 V
is selected.

Fig. 1-2 Input voltage switch at the bottom of the PMR series

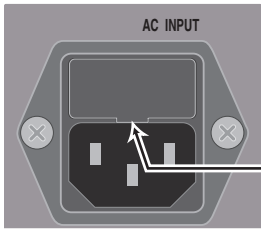

To remove the cover, use
the tip of a slotted screwdriver.

Fig. 1-3 Fuse holder on the rear panel

1.5 AC power cord connection

The power cord that is provided varies depending on the destination for the product at the factory-shipment.

⚠ WARNING • This instrument is designed to operate from the overvoltage category II. Do not operate if from the overvoltage category III or IV.

- The AC power cord for 100 V system shown in Fig.1-4 has a rated voltage of 125 V AC. If this AC power cord is used at the line voltage of a 200 V system, replace the power cord with that satisfying that line voltage.

Appropriate power code must be selected by qualified personel (those who have electrical knowledge).

If such a power cord cannot be obtained, contact your Kikusui distributor/agent.

Do not use the power code attached to this product for the power code of other instruments.



[85-AA-0004]
PLUG:NEMA5-15

Power cord for 100 V system
Rated voltage: 125 VAC
Rated current: 10 A



[85-AA-0005]
PLUG:CEE7/7

Power cord for 200 V system
Rated voltage: 250 VAC
Rated current: 10 A

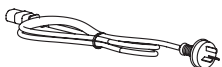

[85-10-0790]
PLUG:GB1002

Fig. 1-4 AC power cord

Connection procedure

1. Confirm that the supply voltage is within the line voltage range of the PMR Series.

AC power that can be input has an allowable voltage range of 90 V to 110 V AC, 106 V to 125 V AC, 180 V to 220 V AC or 211 V to 250 V AC and a frequency range of 50 Hz to 60 Hz.

2. Connect the AC power cord to the AC INPUT connector on the rear panel.

Use the provided power code or power code that is selected by qualified personnel.

3. Plug in the AC power cord.

■ To directly connect to the switchboard:

If the AC power cord is to be connected directly to the switchboard without using a plug, install crimp terminals on the power cord.

-
- ⚠ WARNING**
- To prevent electrical shock, turn off the switchboard before connecting the power cord.
 - Connections to the switchboard must be made by qualified personnel.
-

1.6 Grounding

- ⚠ WARNING** • Not grounding the power supply creates danger of electric shock.
 - Connect the ground terminal to an electrical ground (safety ground).
 - ⚠ CAUTION** • Not performing adequate grounding work on the power supply results in malfunction or the production of large noises from the power supply.
-

To ensure safety, provide secure grounding.

The power supply can be grounded by the method specified below. Note that no grounding terminal is provided on the panels of the power supply.

- Plug the AC power cord into a 3-pole power outlet upon which grounding construction has been performed.

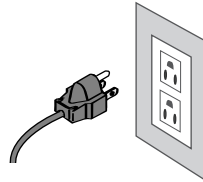

Chapter 2 Precautions and Preparations for Use

This chapter contains essential descriptions that must be understood by the user. This chapter must be read thoroughly before operation is begun.

2.1 Inrush current

During startup, an inrush current of approximately 70 A may be generated. If you are planning to use several sets of the power supply in a system, and to turn on the POWER switches at the same time, check that the AC power source or the switchboard is of sufficient capacity.

When turning on/off the POWER switch, allow an interval of at least 3 seconds between turning it on and turning it off. Otherwise, the inrush current may shorten the life of the power fuse and POWER switch.

2.2 Anti-polar voltage

When the OUTPUT switch is off and the voltage or current is set to 0, an anti-polar voltage of up to approximately 0.6 V may be supplied to the outputs. This voltage may cause the load to be exposed to a reverse current of approximately 1 mA.

2.3 Load

Note that the output may become unstable when one of the following loads is connected.

2.3.1 When load current has peaks or is pulse-shaped

The current meter on the power supply indicates only mean values. Even when the indicated value is less than the preset current value, therefore, a peak may exceed the preset current value. In such a case, the power supply is instantaneously put into constant-current operation mode, and the output voltage drops accordingly. If you look carefully, you will see the constant current (CC) indicator light up dimly.

For such a load, a larger value should be preset for the constant current, or the current capacity should be increased.

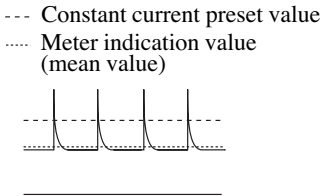

Fig. 2-1 Load current with a peak

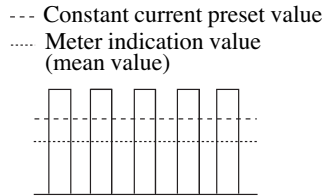

Fig. 2-2 Pulsing load current

2.3.2 When a load generates a reverse current to the power supply

The PMR series is unable to absorb a reverse current from a load. Therefore, if a power-regenerative load, such as an inverter, converter, or transformer that tends to regenerate power to the power supply, is connected, the output voltage may increase, resulting in unstable output.

To handle this type of load, connect a resistor R_D to bypass reverse currents, as illustrated in Fig. 2-3. Note that, if such a resistor is used, the current capacity for the load decreases by I_{rp} .

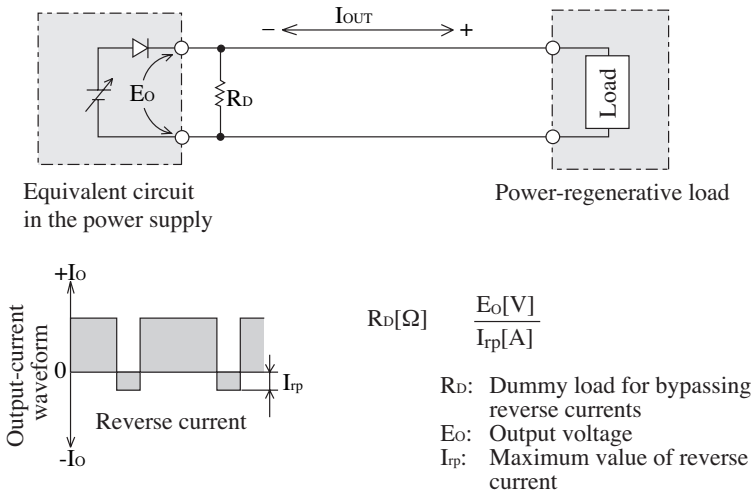

Fig. 2-3 Countermeasure against a power-regenerative load

⚠ CAUTION • Select a resistor R_D with sufficient rated power. Use of a resistor with insufficient rated power may burn the resistor R_D .

2.3.3 In case of load with accumulated energy, such as batteries

When a load, such as a battery, that contains accumulated energy, is connected, the load can send a large current to the capacitor inside the power supply via the protective diode on the output control circuit inside the power supply, thereby the power supply or shortening the life of the load.

To handle this type of load, connect in series a diode D between the power supply and the load for reverse-current prevention.

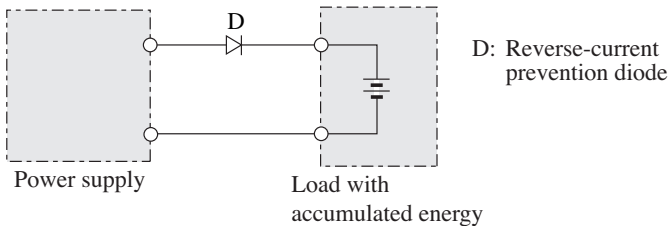

Fig. 2-4 Countermeasure against a load with accumulated energy

-
- ⚠ CAUTION** • To protect the power supply and the load, select a reverse-current prevention diode that meets the following requirements:
1. Reverse-voltage tolerance: At least two times the rated output voltage of the power supply
 2. Forward current capacity: Three to ten times the rated output current of the power supply
 3. A diode with small loss
- Be sure to take account of heat generation from the diode D. The diode may burn unless adequately dissipated.
-

2.4 Constant-voltage and constant-current power supplies

The PMR series is capable of both constant voltage and constant current operation. The following describes these operation.

Constant-voltage (CV) operation

For example, apply 20 V to a 100 Ω load for constant-voltage operation using the PMR35-1.2DU, as shown in Fig. 2-5.

Supposing that a maximum current of up to 0.4 A can be supplied to the load, set the output of the PMR35-1.2DU to 20 V/0.4 A. Since 20 V is applied to a 100 Ω load, a current of 0.2 A is supplied to the load (point “a” in the figure). If the resistance of the load changes to 50 Ω , the output of the power supply is 20 V/0.4 A (point “b” in the figure). As shown in the figure, when the resistance of the load is between 50 Ω and ∞ , the power supply maintains the output voltage at 20 V. If the resistance of the load falls below 50 Ω , the power supply automatically shifts to constant-current (CC) operation and thus maintains the current at 0.4 A. Simultaneously, the output voltage falls below 20 V.

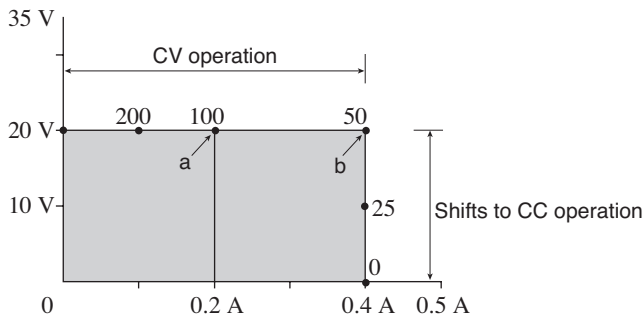

Fig. 2-5 Constant-voltage (CV) operation

Constant-current operation

For example, apply 0.2 A to a 100 Ω load using the PMR35-1.2DU to perform constant-current (CC) operation, as illustrated in Fig. 2-6. Supposing that a maximum voltage of up to 30 V can be provided to the load, set the PMR35-1.2DU output to 30 V/0.2 A. Since 0.2 A is supplied to the 100 Ω load, voltage of 20 V is applied to the load (point “a” in the figure). If the resistance of the load changes to 150 Ω , the output of the power supply is 30 V/0.2 A (point “b” in the figure). As shown in the figure, when the resistance of the load is between 0 Ω and 150 Ω , the power supply maintains the output current at 0.2 A. If the resistance of the load rises above 150 Ω , the power supply automatically shifts to constant-voltage (CV) operation and thus maintains the voltage at 30 V. Simultaneously, the output current falls below 0.2 A.

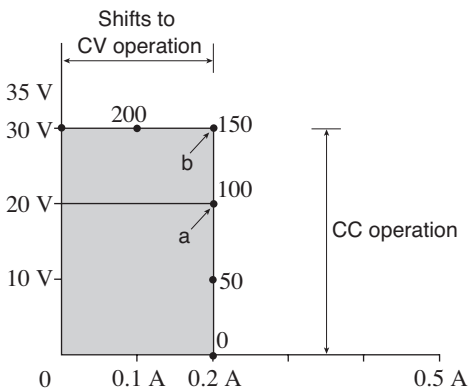

Fig. 2-6 Constant-current (CC) operation

2.5 OHP alarm

The overheat protection (OHP) function is activated when the internal temperature of the power supply becomes excessively high the fan motor stops due to a foreign substance in the fan, or when the air inlet or outlet is mistakenly choked. (Fig. 2-7)

When the OHP function is activated, the outputs are cut off and the indication “OHP” appears on the voltmeter on the front panel. Simultaneously, an alarm signal is output from terminals 11 and 12 of the J1 terminal board on the rear panel. (Fig. 2-8)

To cancel the OHP state, turn off the POWER switch and eliminate the cause of the problem, and then turn on the POWER switch.

Note that the OHP function is reactivated if the POWER is turned off before the internal temperature of the power supply falls to a certain level.



WARNING • Improper handling of the J1 terminal board may result in electrical shock. When performing wiring to the alarm signal terminal, be sure to refer to “4.1.1 J1 Terminal Board.”

An alarm signal is output via the open-collector-type photo-coupler, which insulates the alarm signal terminal from the other terminals.

Maximum rated value: V_{CEO} : 80 V, I_C : 50 mA, P_C : 150 mW



Fig. 2-7 OHP alarm indicator

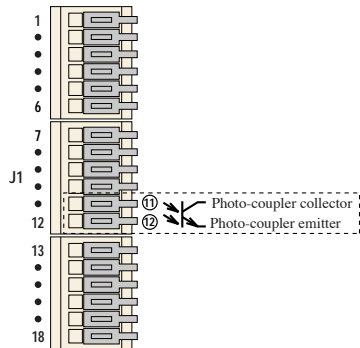

Fig. 2-8 OHP alarm output

2.6 Output channel number

In the PMR series, an output channel (OUTPUT CH) number is assigned to each output. The number is used to identify each output when the power supply is run by remote control. The following table shows the correspondence between the output of each model and the OUTPUT CH number.

Table 2-1 Correspondence between the output of each model and the OUTPUT CH number

Model	OUTPUT CH1	OUTPUT CH2	OUTPUT CH3	OUTPUT CH4
PMR18-2.5DU	+18 V output	-18 V output		
PMR35-1.2DU	+35 V output	-35 V output		
PMR18-1.3TR	+18 V output	-18 V output	6 V output	
PMR25-1TR	+25 V output	-25 V output	6 V output	
PMR24-1QU	+24 V output	-24 V output	+12 V output	-12 V output

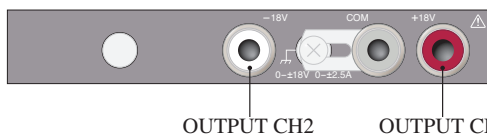

Fig. 2-9 PMR-DU-type output terminal

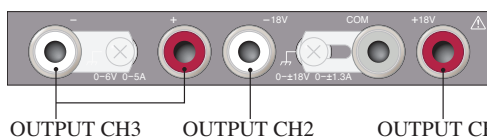

Fig. 2-10 PMR-TR-type output terminal

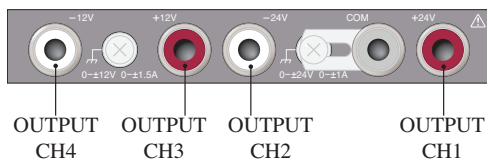

Fig. 2-11 PMR-QU-type output terminal

2.7 Output terminal cover

An output terminal cover is included with the PMR series. Before operating the power supply, attach the cover.

In the case of attaching the cover to PMR-TR and PMR-QU types

The outlet for the load cable is closed at the time of shipment. If the outlet is to be used as follows:

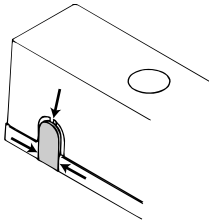

Cut the three points indicated with an arrow using a tool such as a nipper.

Fig. 2-12 Outlet for the load cable

Installing the cover

Washer

The chassis ground terminal must be used to install the output terminal cover. Thus, depending on whether the short bar is connected to the chassis ground terminal, a level difference will occur between the left and right installation positions. The accompanying washer can be used to eliminate this difference.

Cover installation procedure

1. Make sure the POWER switch is OFF.
2. Make sure the load cable is connected securely.
3. Remove the screws (M4 x 8) on the chassis ground terminal at the time of shipment.
4. Install the cover using mounting screws (M4 x 16). See Fig. 2-14.
When a level difference occurs in the short bar between the installation positions, insert the washer to eliminate the difference.

⚠ CAUTION • Be sure to use the screws accompanying the cover.

- NOTE**
- The PMR-DU and PMR-QU types are shipped with a screw and washer in the mounting hole on the left side of the cover (Fig. 2-13). If the short bar is not to be used, remove the washer before installing the cover.

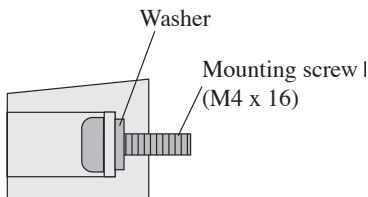
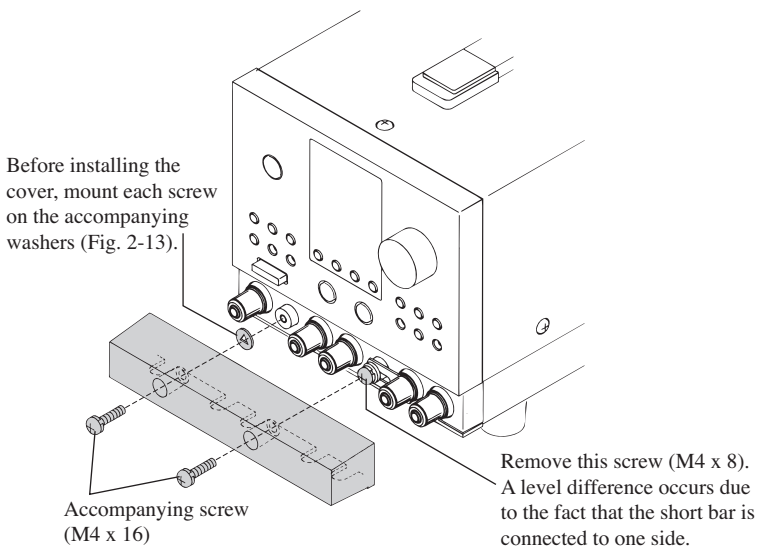
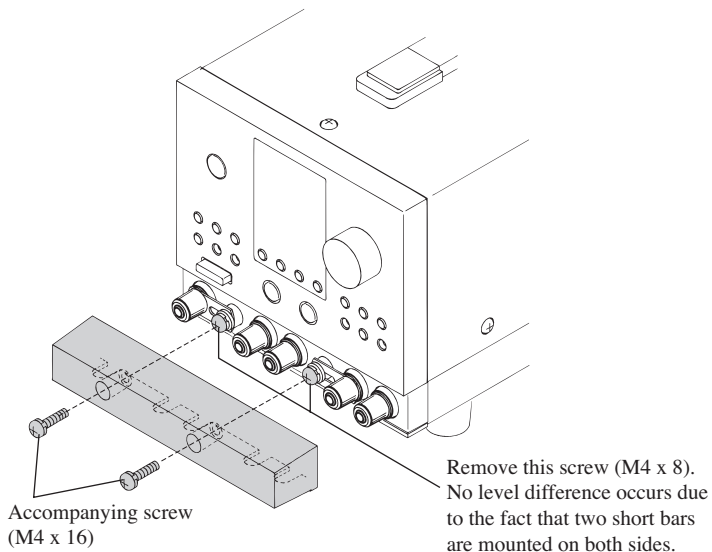

Fig. 2-13



When using a washer to install the cover



When no washer is needed to install the cover

Fig. 2-14 Installing the output terminal cover

This chapter explains the basic operations of the front panel, series operations using output terminals, and the MODE switches on the rear panel.

3.1 Turning on the power

- ⚠ CAUTION** • Before turning on the POWER switch, be sure to check the MODE switch settings on the rear panel. Note that, if the POWER switch is turned on with PWR ON OUTPUT on the MODE switch ON, a preset voltage or current is supplied to the load.

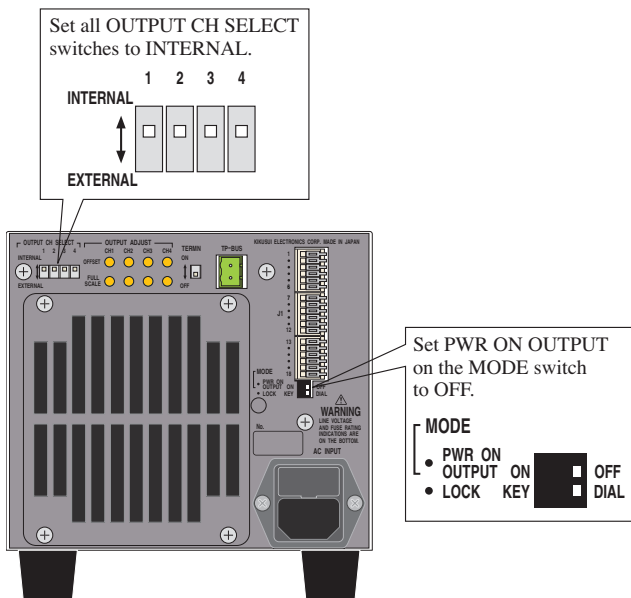
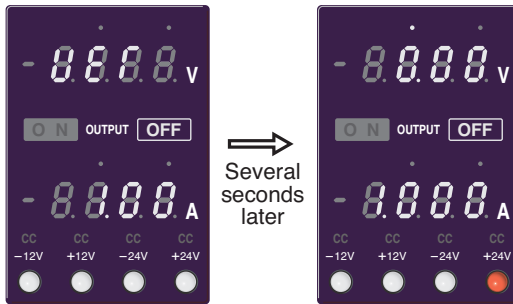

Fig. 3-1 Settings on the rear panel prior to startup

Turning on the power procedure

1. Make sure the POWER switch is OFF.
2. On the rear panel, make sure PWR ON OUTPUT on the MODE switch is OFF. (Fig. 3-1)
3. On the rear panel, make sure all OUTPUT CH SELECT switches are set at INTERNAL. (Fig. 3-1)
4. Make sure the AC power cord is connected properly.
5. Turn on the POWER switch.
6. The ammeter on the display will show ROM version No. "x.xx" for a few seconds. (Fig. 3-2)
7. Several seconds later, the PMR series becomes ready for output settings.

The above steps ready the power supply for operation.



Indicates ROM version No.

Ready for output settings

Fig. 3-2 Display at startup (on PMR24-1QU)

3.2 Basic operations

This section describes how to make output settings and how to use the PMR series as a constant-voltage or constant-current power supply.

3.2.1 Output settings

Here, the PMR24-1QU type is used as an example for setting the 24 V output current to 0.35 A.

Fig. 3-3 shows the values at startup. These values are preset at the time of shipment and appear first when the POWER switch is turned on.

The PMR series saves in memory the preset output values and the ON/OFF status of the DIAL/KEY LOCK switch that are effective immediately before the POWER switch is turned off. The next time the POWER switch is turned on, the same values and status are set on the power supply. Note, therefore, that the voltage and current values and the ON/OFF status of the DIAL/KEY LOCK switch may differ from those shown in Fig. 3-3. The switches and LEDs indicated with **Lighting** light up the instant the power is turned on. For the settings made at the time of shipment, see Table 3-1.

COARSE/FINE

When making output-voltage and output-current settings, the user can select between COARSE and FINE.

With COARSE, the voltage and current can be set at increments of 1 V and 0.1 A, respectively. With FINE, they can be set at increments of 0.01 V and 0.001 A. For 6 V output (OUTPUT CH3) of the PMR-TR type, however, the voltage can be set at increments of 0.1 V with COARSE and at increments of 0.001 V with FINE.

The COARSE/FINE status is indicated by two position LEDs on the voltmeter and the ammeter. The LED on the left indicates COARSE, and the LED on the right indicates FINE.

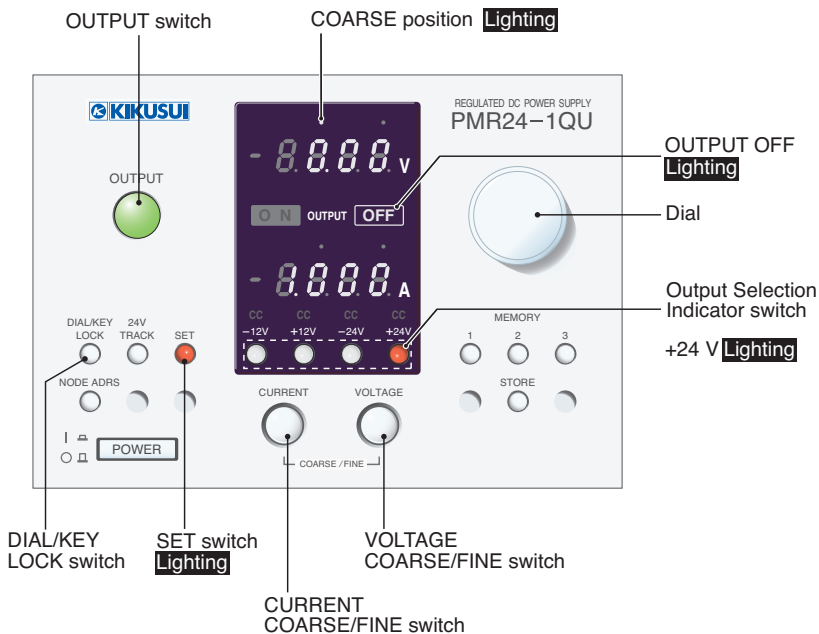

Fig. 3-3 Display and settings at startup (PMR24-1QU)

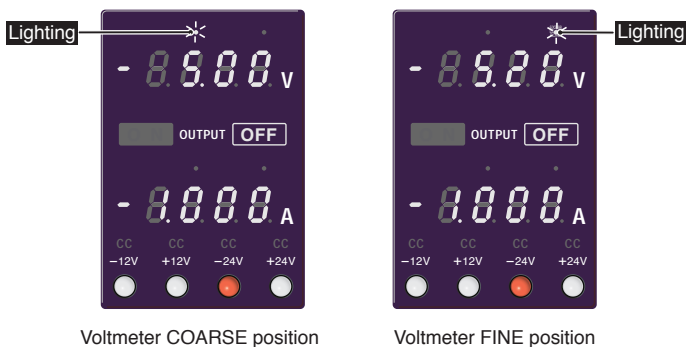

Fig. 3-4 Voltmeter COARSE/FINE position

■ To set the -24 V output to -5.2 V and -0.35 A

1. Make sure the DIAL/KEY LOCK switch is OFF.
If this key is ON, output settings cannot be made.
2. Make sure the SET switch is ON.
If this switch is OFF, a real output value is displayed on the panel.
3. Make sure OUTPUT OFF is lit up on the display.

NOTE

- When the OUTPUT switch is turned ON, the SET switch, if lit up, automatically goes off, and an output value is displayed.
 - If the dial is turned with the OUTPUT switch OFF, the SET switch automatically lights up if it is off, and the power supply becomes ready for settings.
-

4. On the Output Selection Indicator switch, press the -24 V switch.
The -24 V switch lights up to display the effective set value for the -24 V output.
5. Make sure the COARSE position on the voltmeter lights up.
6. As the dial is turned, the figure below the COARSE position changes. Set the figure to “5.” (Fig. 3-4)
7. Press the VOLTAGE COARSE/FINE switch once.
The COARSE position on the voltmeter goes off, and the FINE position on the voltmeter lights up.
8. As the dial is turned, the figure below the FINE position changes. Set the figure to “20.”

The above steps complete the voltage setting. To make setting for the current, proceed to the step 9.

9. Press the CURRENT COARSE/FINE switch once.
The FINE position on the voltmeter goes off, and the COARSE position on the ammeter lights up.
10. As the dial is turned, the figure below the COARSE position changes. Set the figure to “0.3.”
11. Press the CURRENT COARSE/FINE switch once.
The COARSE position on the ammeter goes off, and the FINE position on the ammeter lights up.
12. As the dial is turned, the figure below the FINE position changes. Set the figure to “50.”

The above steps complete the current setting. To make settings for other outputs, take the same steps.

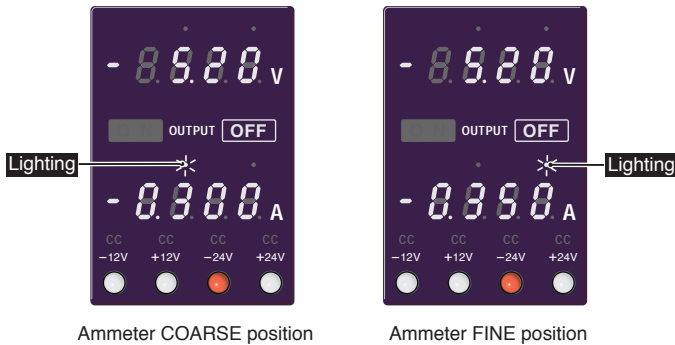

Fig. 3-5 Ammeter COARSE/FINE position

Table 3-1 Settings at the time of shipment

Item on the front panel	Setting
Preset output voltage	0 V for all outputs
Preset output current	Rated current for each output
DIAL/KEY LOCK switch	OFF
Node address	5
Memories 1, 2, and 3	With all outputs for the three memory units, voltage: 0 V; current: rated current

Item on the rear panel		Setting
OUTPUT CH SELECT switch		All INTERNAL
OUTPUT ADJUSTMENT Variable resistor	OFFSET	All Center* ¹
	FULL SCALE	All turned fully counterclockwise* ¹
TERMN switch		ON
MODE switch	PWR ON OUTPUT	OFF
	LOCK	DIAL

*1: Do not turn the variable resistor of OUTPUT ADJUST CH4 on the PMR-TR type. If you have turned the variable resistor of OUTPUT ADJUST CH4 on the PMR-TR type, it causes an effect to the output of CH3 due to its circuit design. In case you have turned the variable resistor of OUTPUT ADJUST CH4, refer to the page 4-11.

For the functions of the switches and other components, see “Chapter 5: Components and Functions.”

3.2.2 Using as a constant-voltage power supply

To use the PMR series as a constant-voltage power supply, follow these steps.

1. Make sure the POWER switch is OFF.
2. On the rear panel, make sure PWR ON OUTPUT on the MODE switch is OFF.
3. Connect a load to the relevant output terminal.
For load connections, see “3.3 Load Connections.”
4. Turn ON the POWER switch.
5. On the display, make sure OUTPUT OFF is lit up.
6. Make sure the SET switch is lit up.
7. Using the Output Selection Indicator switch, select the output to be set.

Then make sure the relevant switch is lit up.

8. Select between COARSE and FINE by pressing the CURRENT COARSE/FINE switch.
9. By turning the dial, set a current value that can be applied to the load.

The value set here is used as a current-limiting value.

10. By pressing the CURRENT COARSE/FINE switch, select between COARSE and FINE.
11. By turning the dial, set the necessary voltage.
12. To use other outputs, repeat Steps 7 through 11.
13. Press the OUTPUT switch.
Make sure OUTPUT ON is lit up.

14. A voltage is applied to each output terminal.

NOTE • With the PMR series operating as a constant-voltage power supply, if the current-limiting value set in Step 9 above is exceeded due to load fluctuations, the power supply shifts to constant-current operation. If a shift occurs, “CC” lights up above the relevant Output Selection Indicator switch.

3.2.3 Using as a constant-current power supply

To use the PMR series as a constant-current power supply, follow these steps.

1. Make sure the POWER switch is OFF.
2. On the rear panel, make sure PWR ON OUTPUT on the MODE switch is OFF.
3. Connect a load to the relevant output terminal.
For load connections, see “3.3 Load Connections.”
4. Turn ON the POWER switch.
5. On the display, make sure OUTPUT OFF is lit up.
6. Make sure the SET switch is lit up.
7. Using the Output Selection Indicator switch, select the output to be set.

Then make sure the relevant switch is lit up.

8. By pressing the VOLTAGE COARSE/FINE switch, select between COARSE and FINE.
9. By turning the dial, set the voltage value to be applied to the load.

The value set here is used as the voltage-limiting value.

10. By pressing the VOLTAGE COARSE/FINE switch, select between COARSE and FINE.
11. By turning the dial, set the necessary current.
12. To use other outputs, repeat Steps 7 through 11.
13. Press the OUTPUT switch.

Make sure OUTPUT ON is lit up.

14. A current is applied to each output terminal.
“CC” is indicated above the Output Selection Indicator switch that corresponds to the output used.

NOTE

- With the PMR series operating as a constant-current power supply, if the voltage-limiting value set in Step 9 above is exceeded due to load fluctuations, the power supply shifts to constant-voltage operation. If a shift occurs, “CC” goes off above the relevant Output Selection Indicator switch.
-

3.3 Load connections

- ⚠ WARNING** • To ensure safety, turn off the POWER switch before connecting a load.
- Use a cable for load connection (load cable) with a sufficient current capacity for the rated current of the power supply.
 - After connecting the load cable, install the output terminal cover.
- ⚠ CAUTION** • To securely connect the load cable to an output terminal, use crimp terminals.
- With the PMR-DU and PMR-QU types, outputs are provided for the COM terminal.
 - With the PMR-TR type, a 6 V output is independent of ± 18 V (± 25 V) COMMON outputs.

Fig. 3-7 shows an example of the connection of a load cable to the +24 V terminal on the PMR24-1QU. The same steps are applicable to other types.

To connect a load to the 6 V output terminal on the PMR-TR type, see Fig. 3-8.

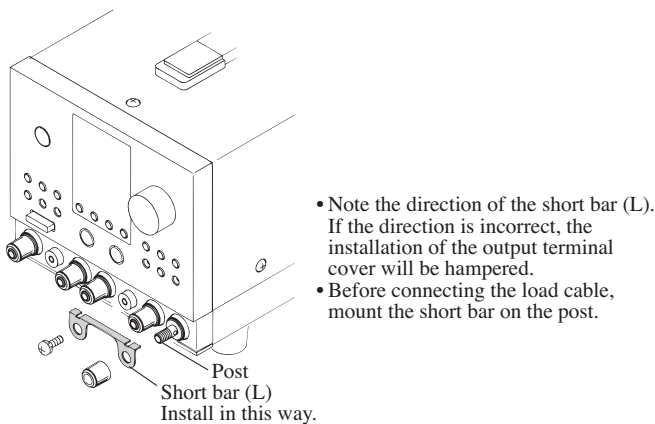
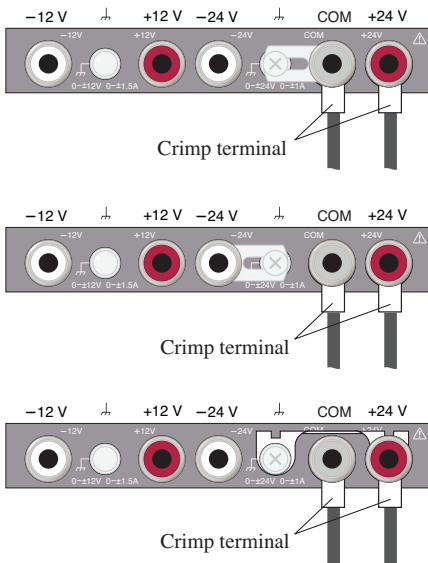

Fig. 3-6 Installing the short bar (L)



Ground the COM terminal.

Using the short bar (S), connect the chassis ground terminal to the COM terminal.

Ground the negative (-) output terminal.

Using the short bar (S), connect the chassis ground terminal to the negative (-) output terminal.

Ground the positive (+) output terminal.

Using the short bar (L), connect the chassis ground terminal to the positive (+) output terminal. (Fig. 3-6)

Fig. 3-7 Connection to the output terminal (example for the +24 V output on the PMR24-1QU)

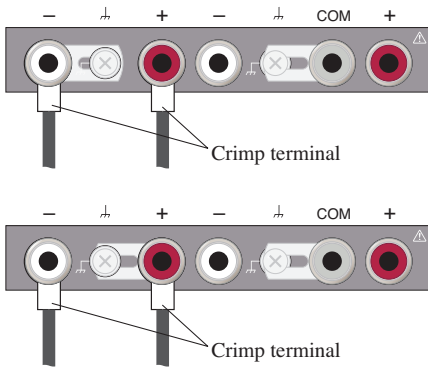

Ground the negative (-) output terminal.

Using the short bar (S), connect the chassis ground terminal to the negative (-) output terminal.

Ground the positive (+) output terminal.

Using the short bar (S), connect the chassis ground terminal to the positive (+) output terminal.

Fig. 3-8 Connection to the 6 V output terminal (for the PMR-TR type only)

Upon completion of the connection of the load cable, install the output terminal cover. For the cover installation procedure, see “2.7 Output Terminal Cover.”

3.4 Tracking operations

The PMR series is equipped with a tracking function that permits positive and negative (\pm) output voltages to change at the same rate.

When the dial is turned during tracking operation, outputs change at the same rate as the preset \pm outputs (b/a), as shown in Fig. 3-9.

That is,

$$b/a = d/c.$$

In tracking operation, the voltage can be changed between 0 V and the rated value, provided that the power supply stays within the constant-voltage operation range. Note, however, that tracking is performed at between 0% and 200% of the output displayed when the TRACK switch is pressed. Thus, once either the positive or negative output reaches the rated value, the voltage ceases to change. In addition, if either the positive or negative output exceeds the current-limiting value, the voltage of the output decreases in accordance with the load applied, while the voltage of the other outputs remains unaffected.

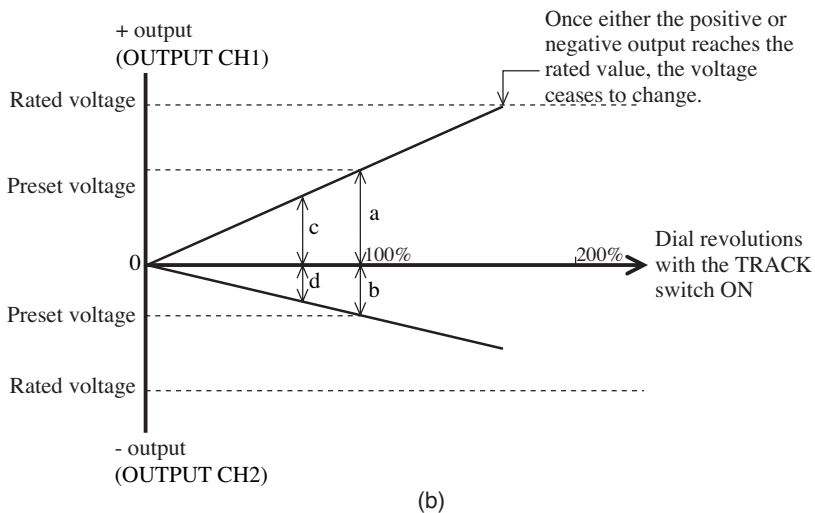
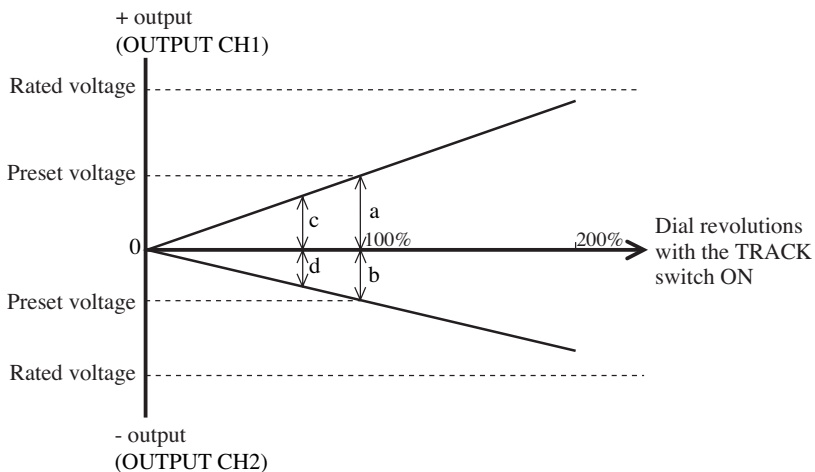

Fig. 3-9 Voltage settings and tracking outputs

Setting resolution during tracking operation

The setting resolution of the dial during tracking operation is as follows.

- With COARSE, 1% for the value set when the TRACK is pressed;
- With FINE, 0.1% for the value set when the TRACK is pressed.

NOTE

- The output resolution is limited with the least figure of the indicator. Therefore, when the TRACK switch is pressed with the following condition, the output may not change even if you turn the dial.

With COARSE, when the voltage set value is 0.99 V or less, or the current set value is 0.099 A or less;

Or with FINE, when the voltage set value is 9.99 V or less, or the current set value is 0.999 A or less.

In the above condition, continue turning the dial until the output and the displayed value begin to change.

Outputs compatible with tracking operation

PMR-DU type:

+18 V (+35 V) and -18 V (-35 V) outputs

PMR-TR type:

+18 V (+25 V) and -18 V (-25 V) outputs

PMR-QU type:

+24 V and -24 V outputs

Tracking procedure

1. Set an output value.
2. Press the TRACK switch.
Make sure the switch is lit up.
3. Turn the dial to set it to the target output.

To stop the tracking operation, press the TRACK switch.

3.5 Memory function

With the memory function, the PMR series can store up to three voltage and current values. These values can be recalled when necessary.

Storing set values

For each output, the present set value is stored in memory. Before storing the data, make settings for each output.

1. Press the STORE switch. The MEMORY 1, 2, and 3 switches light up.
2. Using the MEMORY 1, 2, and 3 switches, select the memory to be used for storing the data. Only the pressed switch lights up, and the voltage and current values for each output are stored to its memory.

NOTE

- To exit the Store mode, turn the dial or press the STORE switch. Otherwise, the power supply automatically exits the Store mode approximately three seconds after discontinuing operation.
 - The storing operation cannot be performed if the DIAL/KEY LOCK is lit up.
-

Recalling set values

- ⚠ CAUTION** • If a set value is recalled while the OUTPUT switch is on, the recalled value is output. Note that, if an incorrect memory No. is recalled, unexpectedly high power may be applied to the load.

We recommend storing a voltage value and a current value which do not damage the load in the memory which is not used.

1. Press the MEMORY switch with the No. to be recalled.
2. The pressed switch lights up, and the stored voltage and current values for each memory are set.

NOTE

- If the dial is turned with the TRACK switch pressed or the node address altered, the MEMORY switch lamp goes off.
 - If a set value is recalled with the OUTPUT switch on, output is performed at intervals of approximately 1.5 seconds.
-

3.6 Series operation

The PMR series can operate at a high output voltage when a load is connected to both the positive (+) and negative (-) output terminals.

⚠ CAUTION • Series operation is possible only with a single PMR unit. It is not applicable to more than one unit at a time, even if they are of the same PMR type. In addition, the PMR series is not compatible with parallel operation.

3.6.1 PMR-DU type

Fig. 3-10 illustrates series operation with the PMR18-2.5DU or PMR35-1.2DU.

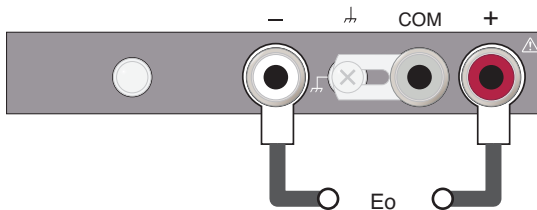

PMR18-2.5DU: $E_o = 0-36\text{ V}, 2.5\text{ A}$
PMR35-1.2DU: $E_o = 0-70\text{ V}, 1.2\text{ A}$

Fig. 3-10 Example of series operation with the PMR-DU type

Fig. 3-10 shows an example of grounding of the COM terminal. To ground the negative (-) or positive (+) output terminal, take the following steps.

Grounding the negative (-) output terminal

Using the accompanying short bar (S), connect the chassis ground terminal to the negative (-) output terminal.

Grounding the positive (+) output terminal

Using the accompanying short bar (L), connect the chassis ground terminal to the positive (+) output terminal.

3.6.2 PMR-TR type

Fig. 3-11 illustrates series operation with the PMR18-1.3TR. Fig. 3-12 shows operation with the +6 V output connected in series.

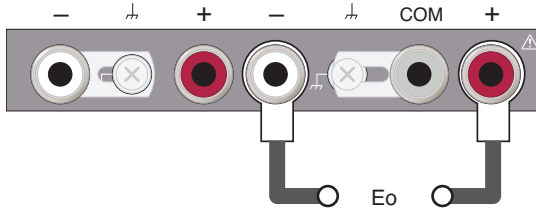

PMR18-1.3TR: $E_o = 0-36 \text{ V}, 1.3 \text{ A}$
PMR25-1TR: $E_o = 0-50 \text{ V}, 1 \text{ A}$

Fig. 3-11 Example 1 of series operation with the PMR-TR type

Fig. 3-11 shows an example of grounding of the COM terminal. To ground the negative (-) or positive (+) output terminal, take the following steps.

Grounding the negative (-) output terminal

Using the accompanying short bar (S), connect the chassis ground terminal to the negative (-) output terminal.

Grounding the positive (+) output terminal

Using the accompanying short bar (L), connect the chassis ground terminal to the positive (+) output terminal.

PMR-TR type (continued)

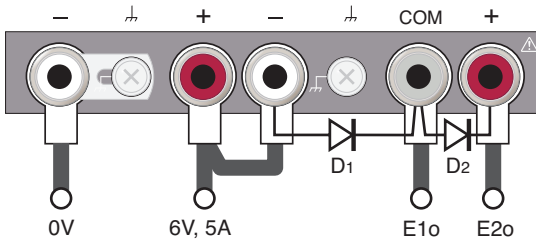

PMR18-1.3TR: E1o = 24V, 1.3A
E2o = 42V, 1.3A
PMR25-1TR: E1o = 31V, 1A
E2o = 56V, 1A

Fig. 3-12 Example 2 of series operation with the PMR-TR type

Fig. 3-12 provides an example of grounding the negative (-) terminal using a 6 V output. To ground the positive (+) terminal, connect the chassis ground terminal to the 6 V positive (+) terminal using the accompanying short bar (S).

-
- ⚠ CAUTION**
- In the connection shown in Fig. 3-12, remove the short bar from the $\pm 18\text{ V}$ ($\pm 25\text{ V}$) output.
 - In the connection shown in Fig. 3-12, if E1o or E2o is short-circuited unintentionally to the 6 V negative (-) terminal, a current of 5 A will be applied to the $\pm 18\text{ V}$ ($\pm 25\text{ V}$) output, resulting in damage to the protected diode in the power supply. Be sure to install D1 and D2 (with a rated value of at least 5 A), as shown in Fig. 3-12.
-

NOTE

- When multiple outputs are used simultaneously, the current value is limited by the rated current.

For example, when the PMR25-1TR is connected as shown in Fig. 3-12, each output can send the following currents (see, Fig. 3-13):

$$a \leq 1$$

$$b \leq 1 - a$$

$$c = 5 - (a + b)$$

a [A]: Current available from the 56 V output.

b [A]: Current available from the 31 V output.

c [A]: Current available from the 6 V output.

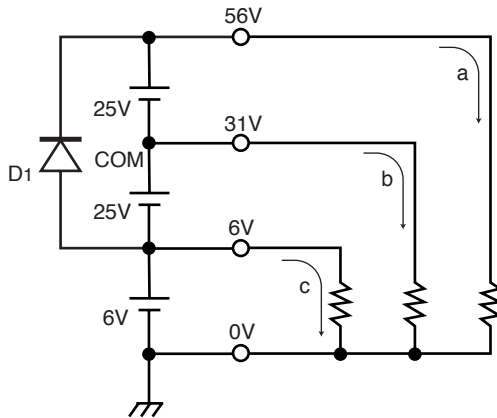

Fig. 3-13 Circuit diagram of Example 2 of series operation (Fig. 3-12)

3.6.3 PMR-QU type

Fig. 3-14 shows an example of series operation with the PMR24-1QU.

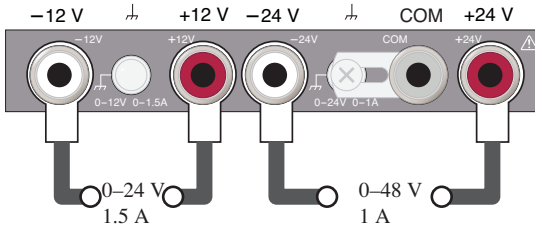

Fig. 3-14 Example of series operation with the PMR-QU type

Fig. 3-14 shows an example of grounding of the COM terminal. To ground the negative (-) or positive (+) output terminal, take the following steps.

Grounding the negative (-) output terminal

Using the accompanying short bar (S), connect the chassis ground terminal to the -24 V output terminal.

Grounding the positive (+) output terminal

Using the accompanying short bar (L), connect the chassis ground terminal to the +24 V output terminal.

⚠ CAUTION • Series operation is not possible if the 24 V and the 48 V output terminals are connected together, as the COM terminal is internally connected to both terminals.

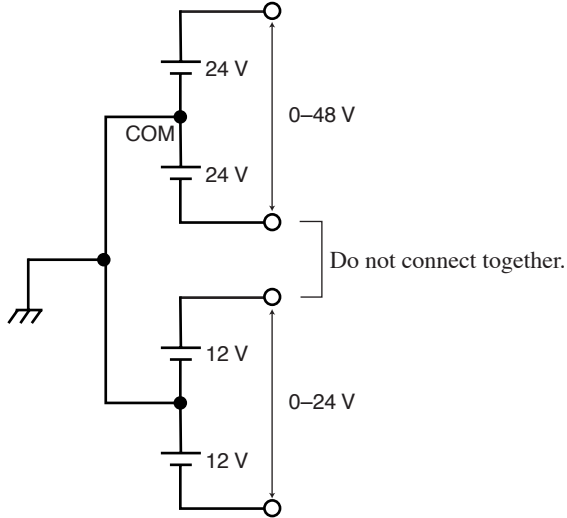

Fig. 3-15 Circuit diagram of Example of series operation (Fig. 3-14)

3.7 Functions of the MODE switches

This section describes the functions of the MODE switches on the rear panel. There are two MODE switches: the PWR ON OUTPUT switch and the LOCK switch.

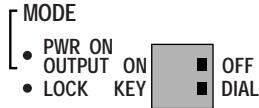

Fig. 3-16 MODE switches on the rear panel

3.7.1 OUTPUT ON operation during startup (POWER ON)

With the PWR ON OUTPUT switch and POWER switch turned on, the PMR series starts up with OUTPUT ON.

CAUTION • With the POWER switch turned on, the power supply outputs the voltage and current values that were effective immediately before the switch was turned off following the previous operation. Thus, before this function is used, make appropriate output settings for the load to be connected.

■ Setting procedure

1. Turn ON the power switch.
2. Set voltage and current values for the output to be used.
3. Turn OFF the POWER switch.
4. Set the PWR ON OUTPUT switch to ON.

NOTE • If the POWER switch is turned ON with the PWR ON OUTPUT switch set at OFF, the power supply starts up with OUTPUT OFF.

3.7.2 LOCK operation

The LOCK switch is used to select operations to be performed when the DIAL/KEY LOCK switch on the front panel is turned on

When the LOCK switch is set at DIAL

If the DIAL/KEY LOCK switch is pressed so that it lights up, the dial is inactivated.

When the LOCK switch is set at KEY

If the DIAL/KEY LOCK switch is pressed so that it lights up, the dial and the switches on the front panel (except the DIAL/KEY LOCK and POWER switches) are inactivated.

■ Setting procedure

1. Turn OFF the POWER switch.
2. Select the operation desired with the MODE LOCK switch.
3. Turn ON the POWER switch.
4. Press the DIAL/KEY LOCK switch so that it lights up, then the LOCK operation operates.

This chapter explains remote control of the PMR series. The following are the two types of remote control for the power supply:

- Analog remote control
- Digital remote control

In analog remote control, the power supply is controlled with a voltage source and a contact connected to the J1 terminal board on the rear panel.

In digital remote control, on the other hand, the power supply is controlled with the power-supply controller PIA4830, PIA4850, or PIA4810 connected to the TP-BUS connector on the rear panel. For details on the PIA4800 series Power Supply Controller, see the operation manual of the respective product. For connection to a Power Supply and device messages, refer to the "Connecting & Programming Guide" in the CD-ROM that came with the PIA4800 series.

4.1 Analog remote control

The PMR series can be controlled with the J1 terminal board on the rear panel, as follows.

- Output voltage control using an external voltage
- Output ON/OFF control using an external contact
- Recall of Memories 1, 2, and 3 using an external contact

4.1.1 J1 terminal board

















This section provides procedures and instructions regarding the connection of the J1 terminal board to be used for analog remote control.

Table 4-1 shows the terminal arrangement of the J1 terminal board.

NOTE

- With the PMR-DU type, terminals 7, 8, 9, and 10 are not operable.
 - With the PMR-TR type, terminals 9 and 10 are not operable.
-

Table 4-1 Terminal arrangement of the J1 terminal board

Terminal No.	Signal	Details	Indication over the sticker on the top panel
1	OUTPUT CH1 CV V CONT	Input for the voltage control of OUTPUT CH1 using an external voltage ($V_{ext} < 11\text{ V}$)	①  OUTPUT CH1 CV-V (DU/TR/QU)
2	COMMON	Common for the internal control circuit (connected to the COM terminal)	② 
3	OUTPUT CH2 CV V CONT	Input for the voltage control of OUTPUT CH2 using an external voltage ($V_{ext} < 11\text{ V}$)	③  OUTPUT CH2 CV-V (DU/TR/QU)
4	COMMON	Common for the internal control circuit (connected to the COM terminal)	④ 
5	NC	No connection	⑤ NC
6	NC	No connection	⑥ NC
7	OUTPUT CH3 CV V CONT	Input for the voltage control of OUTPUT CH3 using an external voltage ($V_{ext} < 11\text{ V}$) (only for the PMR-TR/QU types)	⑦  OUTPUT CH3 CV-V (TR/QU)
8	COMMON	Common for the internal control circuit (connected to the COM terminal)	⑧ 
9	OUTPUT CH4 CV V CONT	Input for the voltage control of OUTPUT CH4 using an external voltage ($V_{ext} < 11\text{ V}$) (only for the PMR-QU type)	⑨  OUTPUT CH4 CV-V (QU)
10	COMMON	Common for the internal control circuit (connected to the COM terminal)	⑩ 
11	OHP(C)	Overheat protection signal Photo-coupler collector output ($V_{CEO}: 55\text{ V}$, $I_C: 50\text{ mA}$, $P_C: 150\text{ mW}$)	⑪  COLLECTOR
12	OHP(E)	Overheat protection signal Photo-coupler emitter output	⑫  EMITTER
13	MEMORY 1 SELECT	Recalls MEMORY 1	⑬  MEMORY 1
14	MEMORY 2 SELECT	Recalls MEMORY 2	⑭  MEMORY 2
15	MEMORY 3 SELECT	Recalls MEMORY 3	⑮  MEMORY 3
16	MEMORY COM	Common for the memory recall signal (having the same electric potential as terminal 18)	⑯ 
17	EXT ON/OFF	Output ON/OFF control	⑰  OPEN: OUTPUT ON
18	EXT ON/OFF COM	Common for ON/OFF (having the same electric potential as terminal 16)	⑱  SHORT: OUTPUT OFF

■ Cable and tools necessary for connection

1. Cable

Single wire: $\phi 0.65$ (AWG22)

Stranded wire: 0.32 mm^2 (AWG22)

2. Slotted screwdriver

Shank diameter: $\phi 3$

Tip width: 2.6 mm

3. Wire stripper

One compatible with the above cable

■ Connection procedure

1. Turn OFF the POWER switch.
2. Using a wire stripper, remove 10 mm of the cable sheath from the cable end.

To ensure smooth removal, use the strip gauge indicated on the top panel of the power supply.

3. As illustrated in Fig. 4-1, insert the cable end into the control terminal.



- Never perform wiring to the J1 terminal with the POWER switch ON. Otherwise, electrical shock may result and the internal terminal may be damaged.
 - The J1 terminal has almost the same potential as the COM terminal in the power supply. If part of the wire extending off a control terminal makes contact with the chassis, electric shock or internal circuit breakage may be caused. Insert wires into the terminals in such a way that bare parts are not exposed.
-

4. Remove the screwdriver from the terminal. Make sure the cable is securely fixed.

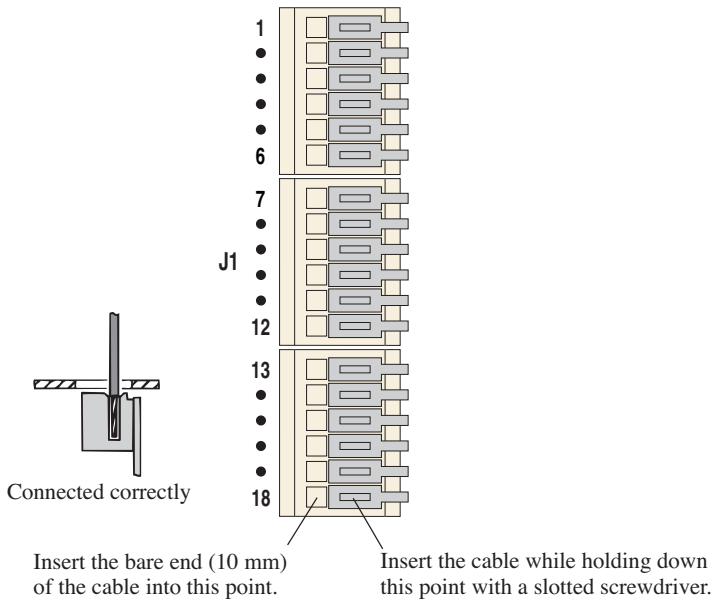

Fig. 4-1 Cable connection to the J1 terminal

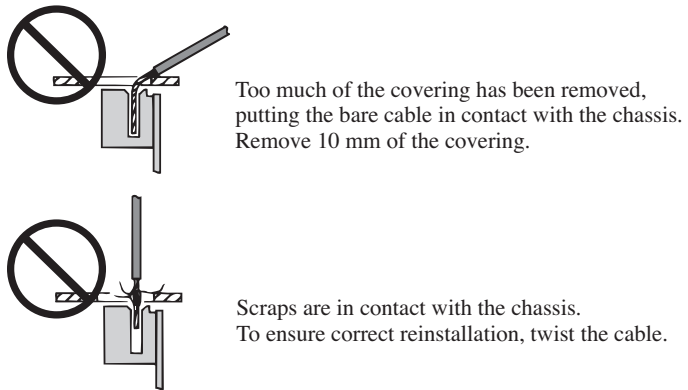

Fig. 4-2 Notes for cable connection

4.1.2 Output voltage control by external voltage

Output voltages can be controlled with an external voltage (V_{ext}) of 0 V to 10 V.

-
- ⚠ CAUTION**
- The COMMON terminals (terminals 2, 4, 8, and 10) on the J1 terminal board are internally connected to the COM terminal on the front panel.
 - With the PMR-TR, the internal circuit for the 6 V output is independent of the internal circuit for other outputs. Input an external voltage value based on the potential at the COMMON terminal on the J1 terminal board. The COMMON terminal is connected to the COM terminal on the front panel.
 - If multiple outputs are to be controlled simultaneously, carefully check the COMMON connections.
-

- NOTE**
- The power supply may not meet the specifications at control with an external voltage, as V_{ext} 's noise and stability affect the output of the power supply.
-

Relationship between the external voltage and the output voltage

As shown below, the output voltage (E_o) is between 0 V and the rated output voltage when the external voltage (V_{ext}) is between 0 V and approximately 10 V.

$$E_o = E_{rtg} \cdot V_{ext} / 10 \text{ [V]}$$

$$0 \leq V_{ext} \leq 10.2 \text{ [V]}$$

E_{rtg} : Rated output voltage [V]

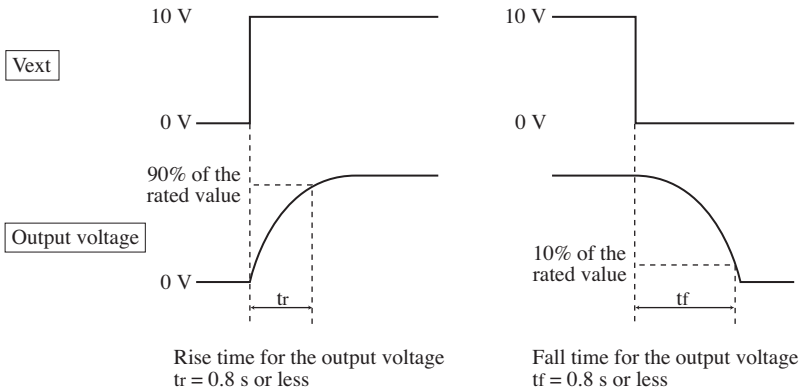

Fig. 4-3 Response time of the output voltage to an external voltage

NOTE

- Above rise time for the output voltage is value when the output current value is set to the rated current. When the current set value is not the rating, the rise time may take long.

■ Connection and setting procedure

1. Turn OFF the POWER switch.
2. Set the OUTPUT CH SELECT switch corresponding to the output to be controlled externally, to EXTERNAL. (Fig. 4-4)
3. Set the arrow on the OUTPUT ADJUST variable resistor corresponding to the output to be controlled externally, to the middle position for both OFFSET and FULLSCALE. (Fig. 4-5)
For PMR-TR type user, see NOTE on page 4-11.
4. Connect Vext to the control terminal corresponding to the output to be externally controlled, as shown in Fig. 4-6.

If more than one output is to be controlled simultaneously using the same COMMON terminal used for Vext, see Fig. 4-7.

-
- ⚠ CAUTION**
- Check the polarity of Vext. If the polarity is incorrect, the power supply may be damaged.
 - If disconnected during operation, Vext may produce external noise and other problems, causing the power supply to malfunction. Securely connect Vext to the terminal.
-

- NOTE**
- The input impedance is approximately 180 k Ω between terminals 1 and 2, terminals 3 and 4, terminals 5 and 6, and terminals 7 and 8 on the J1 terminal board.
-

5. Recheck the connections and settings of the OUTPUT CH SELECT switch.

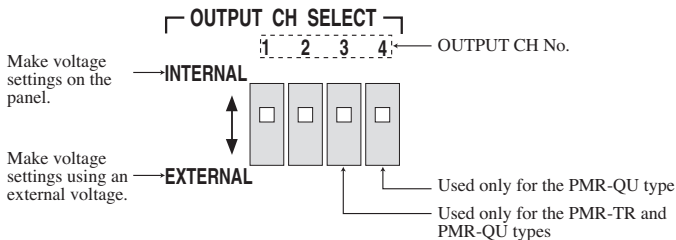

Fig. 4-4 Settings of the OUTPUT CH SELECT switch

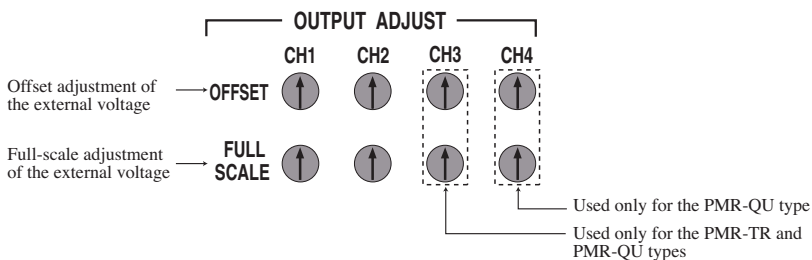

Fig. 4-5 Settings on the OUTPUT ADJUST variable resistor

■ External control

- ⚠ CAUTION** • Do not apply a voltage of 11 V or greater to the control terminal. Otherwise, the power supply may be damaged.

Full-scale and offset adjustment

- If V_{ext} is 10 V, adjust the FULL SCALE variable resistor on OUTPUT ADJUST to set the output voltage to the rated voltage.
- If V_{ext} is 0 V, adjust the OFFSET variable resistor on OUTPUT ADJUST to set the output voltage to 0 V.

- NOTE**
- FULL SCALE and OFFSET affect each other. To obtain the desired values it is necessary to alternate FULL SCALE and OFFSET adjustments. Adjustment may be started using either FULL SCALE or OFFSET, but adjustment can be completed more quickly if you begin with a FULL SCALE adjustment.
 - During external control, the output value differs from the output value (SET value) preset on the panel. When the dial on the panel is turned, the SET value changes, but the output voltage does not. If you set the OUTPUT CH SELECT switch to INTERNAL, the present SET value is output.

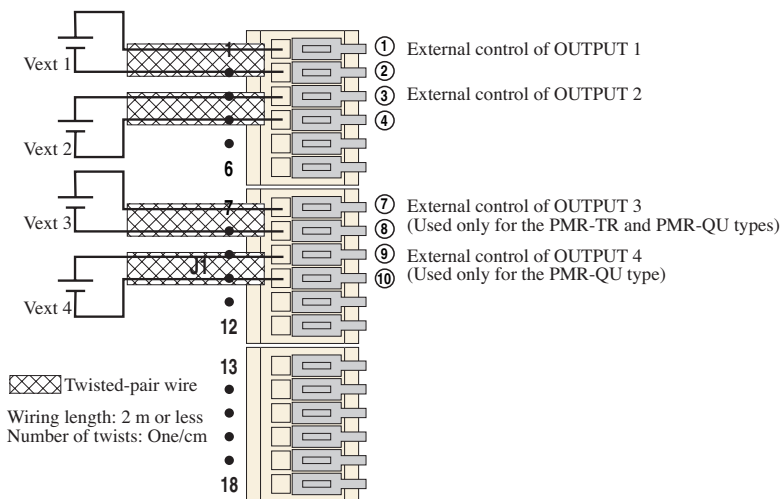

Fig. 4-6 Connecting an external voltage generator (Vext) 1 (using different COMMON terminals for Vext)

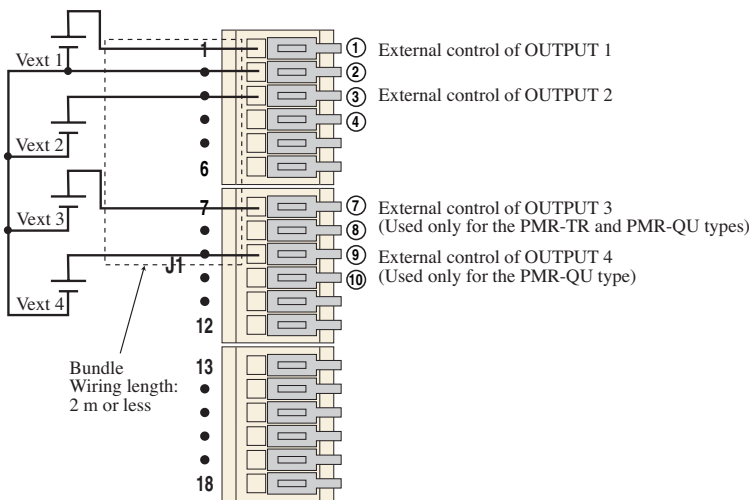

Fig. 4-7 Connecting an external voltage generator (Vext) 2 (using the same COMMON terminal for Vext)

NOTE**• For PMR-TR type user**

The PMR-TR type does not have the OUTPUT CH4, but the output of OUTPUT CH3 is affected with the variable resistor of OUTPUT ADJUST CH4 for reasons of the circuit configuration. If you have turned the variable resistor of OUTPUT ADJUST CH4 by mistake, you may be not able to adjust the full scale and offset with the variable resistor of OUTPUT ADJUST CH3. Adjust the full scale and offset with care so that you do not touch the variable resistor CH4.

If you have turned the variable resistor of OUTPUT ADJUST CH4 by mistake;

1. Turn OFF the POWER switch.
 2. Connect a voltmeter (DVM) to the output terminals of OUTPUT CH3. See Fig. 6-4 of Chapter 6.
 3. Set the OUTPUT CH SELECT switch 3 to EXTERNAL. See Fig. 4-4.
 4. Set arrows on the OUTPUT ADJUST variable resistors CH3 and CH4 to the middle position for both OFFSET and FULLSCALE. See Fig. 4-5.
 5. Turn ON the POWER switch.
 6. Turn ON the OUTPUT switch.
 7. Turn the OFFSET variable resistor of OUTPUT ADJUST CH4 until the DVM reading is within the range of $0\text{ V} \pm 1\text{ mV}$.
 8. Turn OFF the POWER switch.
 9. Connect an external voltage (Vext 3) to terminals 7 and 8 on the J1 terminal board. See Fig. 4-6 .
 10. Turn ON the POWER switch.
 11. Apply $10\text{ V} \pm 50\text{ mV}$ from the Vext 3 to the control terminals.
 12. Turn ON the OUTPUT switch.
 13. Turn the FULL SCALE variable resistor of OUTPUT ADJUST CH4 until the DVM reading is within the range of $6\text{ V} \pm 30\text{ mV}$.
-

4.1.3 Output ON/OFF control by external contact

ON/OFF control of outputs can be performed using an external contact.

■ Connection procedure

1. Turn OFF the POWER switch.
2. As shown in Fig. 4-8, connect contact S (switch) to terminals 17 and 18 on the J1 terminal board.

⚠ CAUTION • Terminals 16 and 18 on the J1 terminal board are connected to each other inside the power supply.

4. Recheck the connections.

■ Turning ON/OFF outputs

- To turn ON outputs, open contact S.
To turn OFF outputs, short-circuit contact S.
- When contact S is opened, you can turn ON/OFF outputs with the OUTPUT switch on the front panel.
The OUTPUT state at power-on depends on the PWR ON OUTPUT setting on the rear panel.
- When contact S is short-circuited, you can not turn ON outputs with the OUTPUT switch on the front panel.
Regardless of the PWR ON OUTPUT setting on the rear panel, the OUTPUT state at power-on is OFF.

⚠ CAUTION • When the wire to the contact S breaks down, the wire was disconnected from the control terminal, or the contact S fails, the OUTPUT state is ON because the contact S works as open even if it short-circuits.
In the environment that it seems that above troubles occur, we cannot recommend the output ON/OFF control by external contact.

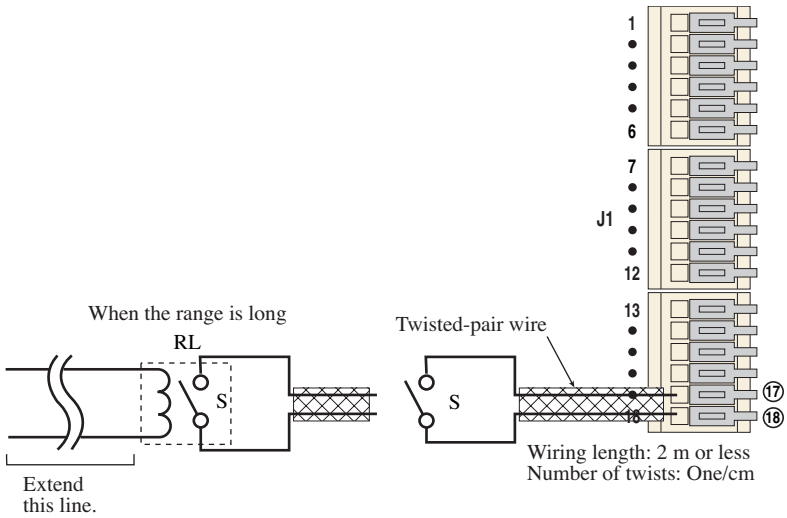

Fig. 4-8 Connecting contact S

DESCRIPTION • Fig. 4-9 shows the equivalent circuit with contact S connected to terminals 17 and 18 on the J1 terminal board.

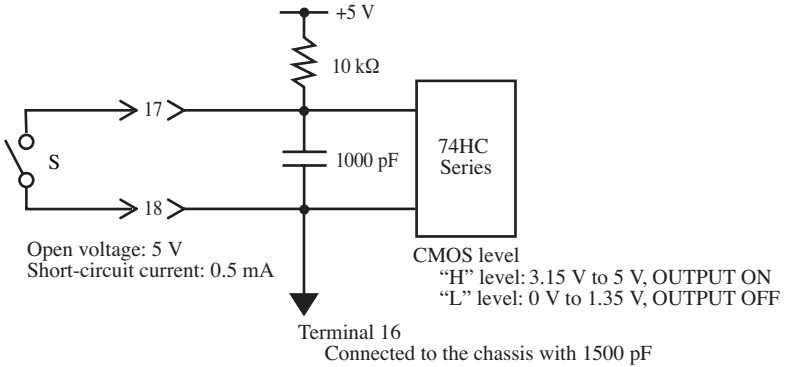

Fig. 4-9 Equivalent circuit

4.1.4 Recall of Memories 1, 2, and 3 by external contact

The set values stored in Memories 1, 2, and 3 can be recalled using an external contact.

■ Connection procedure

1. Turn OFF the POWER switch.
2. As shown in Fig. 4-11, connect contact S (switch) to the control terminal corresponding to the memory you wish to recall.

To use the Push switch, see Fig. 4-12.

⚠ CAUTION • Terminals 16 and 18 on the J1 terminal board are connected to each other inside the power supply.

3. Recheck the connection.

■ Memory recall

To recall a set value, short-circuit the control terminal corresponding to the MEMORY No. you wish to recall to the MEMORY COM terminal. At least 500 ms is necessary for short-circuiting.

DESCRIPTION • Fig. 4-10 shows the equivalent circuit of terminals 13, 14, and 15 on the J1 terminal board.

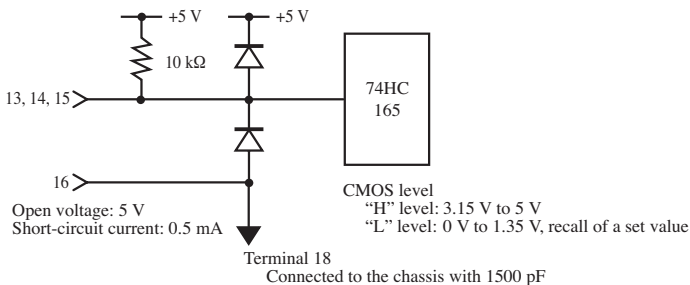

Fig. 4-10 Equivalent circuit

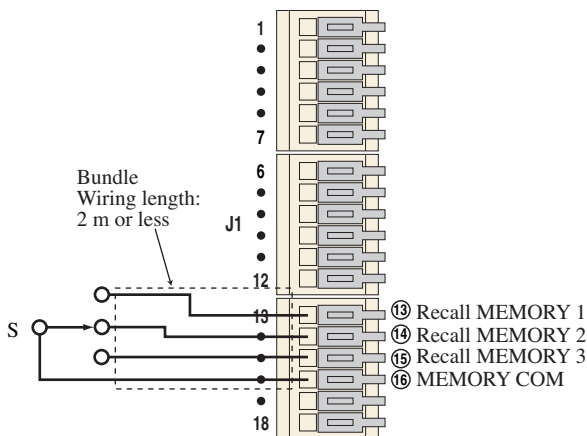

Fig. 4-11 Connecting contact S (1)

⚠ CAUTION • For S, use a non-shorting-type switch.

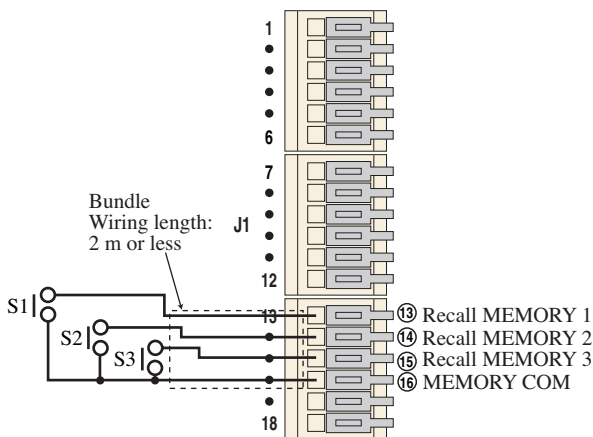

Fig. 4-12 Connecting contact S (2)

⚠ CAUTION • For S1, S2, and S3, use a non-locking-type (momentary) switch.
• Do not press more than one switch at a time.

4.2 Digital remote control

In addition to operating the PMR from the front panel, you can use a power supply controller (PIA4830/PIA4850/PIA4810) to remotely control the PAS via the USB, GPIB or RS232C interface.

-
- NOTE**
- Version 2.00 or later is required for the PIA4800 series. If you are using an earlier version, you need to upgrade. For details, contact your Kikusui agent/distributor. You can confirm a version of the PIA4800 series through the IDN?.
-

4.2.1 Connecting of the Power Supply Controller and Device messages

The PMR and power supply controller are connected via a TP-BUS. Up to 32 devices can be connected to the TP-BUS.

For connection to a Power Supply Controller and device messages, refer to the "Connecting & Programming Guide" [index.html] in the CD-ROM that came with the PIA4800 series.

The "Connecting & Programming Guide" is HTML format. The HTML manual can be viewed using the following browsers.

Operating environment: Windows 98 or later

Browser: Microsoft Internet Explorer 5.5 or later

The list of messages and connection of power supply of Connecting & Programming guide is provided in a PDF file. Adobe Reader 6.0 or later is required to view the file.

The latest version of the "Connecting & Programming Guide" can be downloaded from Web site (<http://www.kikusui.co.jp/en/download/>).

Chapter 5 Components and Functions

This chapter explains the switches, indicators, connectors, and other components located on the front panel.

5.1 Front panel

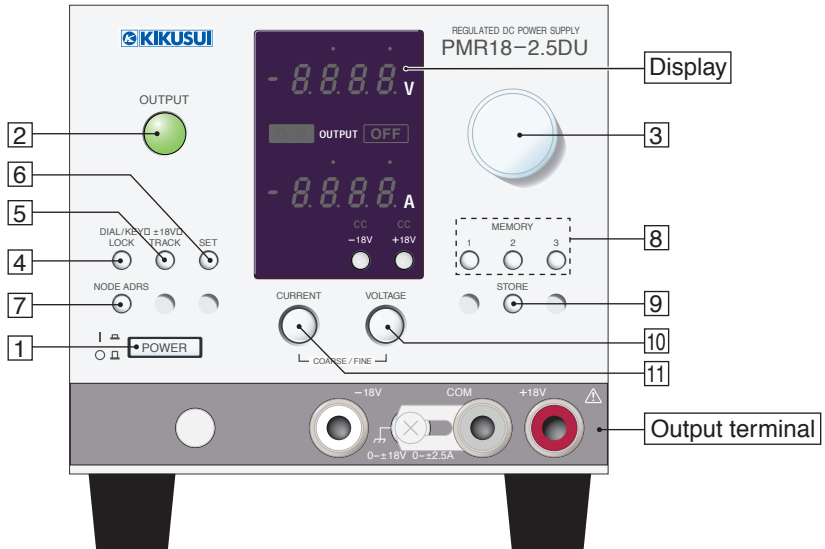

Fig. 5-1 Front panel of the PMR-DU type (PMR18-2.5DU)

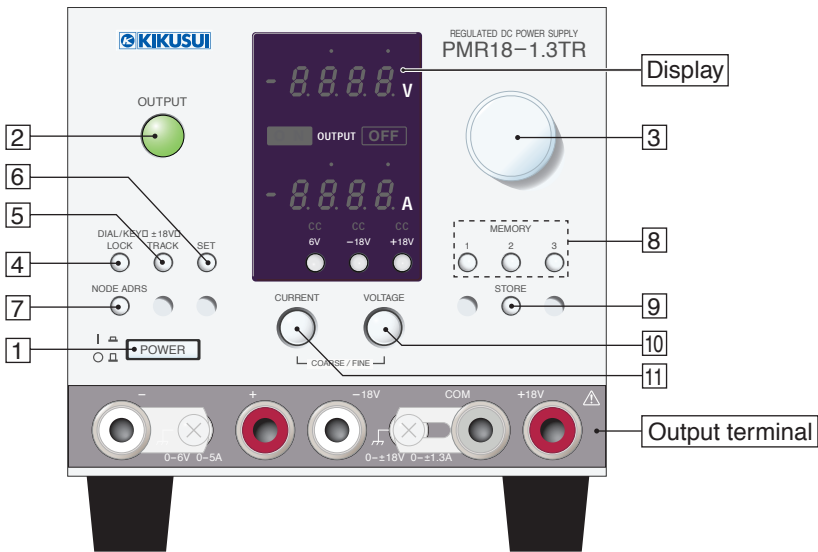

Fig. 5-2 Front panel of the PMR-TR type (PMR18-1.3TR)

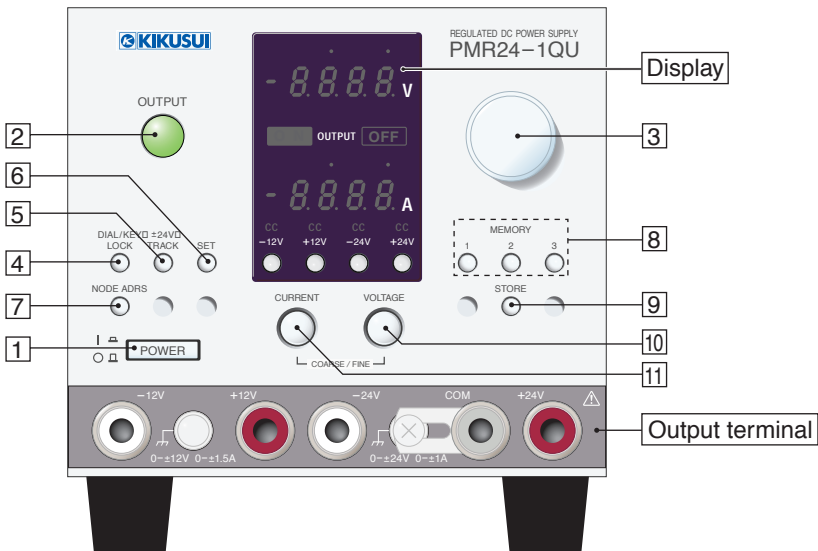

Fig. 5-3 Front panel of the PMR-QU type

1 POWER Switch

Turns the power of the power supply ON and OFF. When pressed in, the switch is ON (I). When released, it is OFF (O).

2 OUTPUT Switch

Used to turn output ON/OFF. Every time it is pressed, the switch shifts between ON and OFF.

3 Dial

When turned clockwise or counterclockwise, the dial sets a voltage, current, or node address.

4 DIAL/KEY LOCK Switch

Used to restrict dialing and switching operations on the front panel. It also disables the storing of a set value to memory.

If this switch is pressed so as to light up, the function selected by the LOCK switch **31** becomes restricted.

5 TRACK Switch

Used to turn tracking operations ON/OFF. Tracking is ON when this switch is pressed so as to light up. Tracking is OFF if the switch is not lit.

Tracking is performed with OUTPUT 1 and OUTPUT 2. For more on the OUTPUT No., see the note on 5-7.

6 SET Switch

Used to set or check the output voltage and output current. When this switch is pressed so as to light up, the set value of the output selected using **18** is displayed. When the switch is not lit, the current value of the output selected using **18** is displayed.

7 NODE ADRS Switch

Used to set or check the node address effective during digital remote control. When pressed, this switch displays the node address on the ammeter on the display.

8 MEMORY Switch

Used to output the set voltage and current values stored in memory. When one of the switches 1, 2, and 3 is pressed so as to light up, the set value in memory is output.

9 STORE Switch

Used to store the set voltage and current values for each output. After this switch is pressed, if one of the three MEMORY switches is pressed, the voltage and current values are stored in memory.

10 VOLTAGE COARSE/FINE Switch

Used in voltage settings to alter the amount of change incurred by a single click of the dial. Pressing this switch toggles setting adjustments between “COARSE” and “FINE.”

11 CURRENT COARSE/FINE Switch

Used in current settings to alter the amount of change incurred by a single click of the dial. Pressing this switch toggles setting adjustments between “COARSE” and “FINE.”

Display

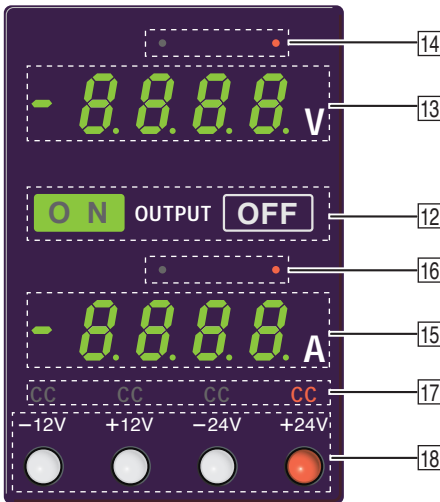

Fig. 5-4 Display on the PMR series (PMR24-1QU)

12 OUTPUT ON/OFF Indicator

“ON” lights when output is ON. “OFF” lights when output is OFF.

13 Voltmeter

When the SET switch is lit, the voltmeter displays the set voltage value of the output selected using **18**. If the SET switch is not lit, it displays the output voltage of the output selected using **18**.

14 VOLTAGE COARSE/FINE Indicator

With COARSE, the LED on the left comes on. Voltage settings can be made to the resolution indicated by the digits. With FINE, the LED on the right comes on, and voltage settings can be made to the resolution indicated by the digits.

During tracking operations, settings can be adjusted in 1% and 0.1% increments for COARSE and FINE, respectively.

15 Ammeter

When the SET switch is lit, the ammeter displays the set current value of the output selected using **18**. If the SET switch is not lit, it displays the current of the output selected using **18**.

16 CURRENT COARSE/FINE Indicator

With COARSE, the LED on the left comes on. Current settings can be made to the resolution indicated by the digits. With FINE, the LED on the right comes on. Current settings can be made to the resolution indicated by the digits.

During tracking operation, settings can be adjusted in 1% and 0.1% increments for COARSE and FINE, respectively.

17 Constant-Current Indicator

The “CC” (Constant Current) LED lights up during constant-current operation.

18 Output Selection Indicator Switch

Used to select an output which you want to set or display a voltage and current. The currently valid output is indicated by the switch that is lit.

Output Terminals

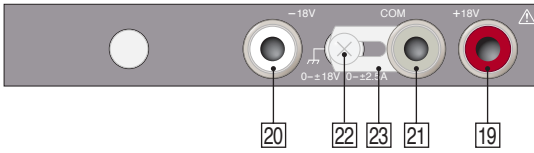

Fig. 5-5 Output terminals on the PMR-DU type

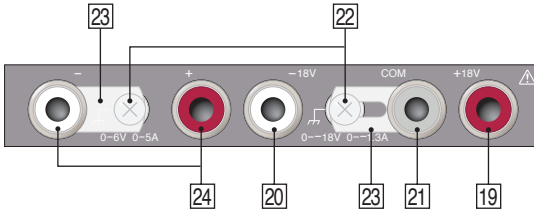

Fig. 5-6 Output terminals on the PMR-TR type

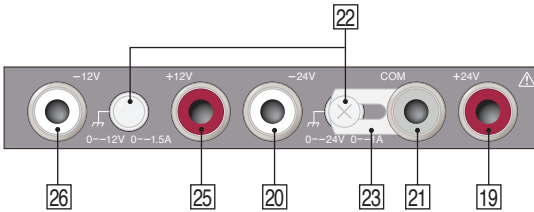

Fig. 5-7 Output terminals on the PMR-QU type



Fig. 5-8 Short bar (L)

19 OUTPUT CH1 Terminal

Supplies positive voltages and currents to the COM terminal.

20 OUTPUT CH2 Terminal

Supplies negative voltages and currents to the COM terminal.

21 COM Terminal

Common terminal for OUTPUT CH1 and OUTPUT CH2.

22 ↓

Chassis ground terminal.

23 Short Bar (S)

Used to connect the OUTPUT CH2 terminal and the COM terminal to the chassis ground terminal.

Also used to connect the negative (-) and positive (+) terminals on the OUTPUT CH3 terminal to the chassis ground terminal. (For PMR-TR type only)

24 OUTPUT CH3 Terminal (for PMR-TR type only)

A 6 V output terminal. Insulated from the COM terminal.

25 OUTPUT CH3 Terminal (for PMR-QU type only)

Supplies positive voltages and currents to the COM terminal.

26 OUTPUT CH4 Terminal (for PMR-QU type only)

Supplies negative voltages and currents to the COM terminal.

27 Short Bar (L)

Used to connect the OUTPUT CH1 terminal to the chassis ground terminal.

NOTE

• OUTPUT CH No.

With the PMR series, an OUTPUT CH No. is assigned to each output. The OUTPUT CH No. is used to identify an output on the power supply during remote-control operation. An OUTPUT CH No. is assigned to an output of each model as follows:

Table 5-1 Correspondence between outputs of each model and OUTPUT CH numbers

Model	OUTPUT CH1	OUTPUT CH2	OUTPUT CH3	OUTPUT CH4
PMR18-2.5DU	+18 V output	-18 V output		
PMR35-1.2DU	+35 V output	-35 V output		
PMR18-1.3TR	+18 V output	-18 V output	6 V output	
PMR25-1TR	+25 V output	-25 V output	6 V output	
PMR24-1QU	+24 V output	-24 V output	+12 V output	-12 V output

5.2 Rear panel

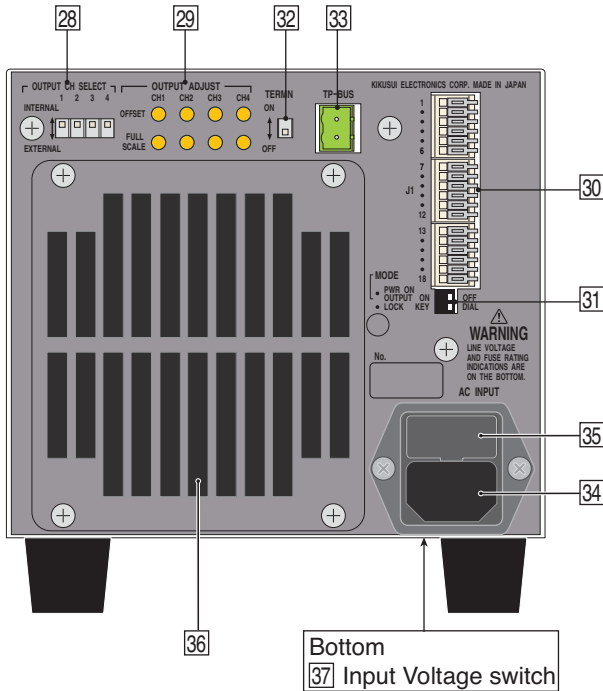

Fig. 5-9 Rear panel on the PMR series

28 OUTPUT SELECT Switch

Used to specify whether to set output voltages using the panel or an external voltage. For details, see “4.1.2 Controlling output voltages using an external voltage source.”

29 OUTPUT ADJUST Variable Resistor

Used for offset and full-scale adjustment during output voltage control using an external voltage. For details, see “4.1.2 Controlling output voltages using an external voltage source.”

30 J1 Terminal Board

Used for analog remote control and some other operations.

⚠️ WARNING • Improper handling can cause electric shocks. When wiring to the terminals, follow the instructions provided in “4.1.1 J1 terminal board.”

31 MODE Switch

Two MODE switches are provided: the PWR ON OUTPUT switch and the LOCK switch. For details, see “3.7 Functions of the MODE switches.”

32 TERMN Switch

Used to turn the termination employed during digital remote control ON/OFF.

33 TP-BUS Terminal

Used to connect the bus during digital remote control.

34 AC INPUT Connector ⚠️

Used to connect the power cord to the power supply.

⚠️ WARNING • Improper handling can cause electric shocks. When making connections, be sure to follow the instructions provided in “1.5 AC power cord connection.”

- To ensure safety, be sure to ground the connector. For details, see “1.6 Grounding.”

35 Fuse Holder

Contains an AC input fuse and a reserve fuse.

 WARNING • Improper handling can cause electric shocks. When replacing or checking the fuse, be sure to follow the instructions provided in “1.4 Checking input power and the fuse.”

36 Exhaust port

Used by the fan to exhaust internal heat. Provide enough clearance around the power supply to ensure a smooth air flow.

37 Input Voltage Switch

Used to shift between different line voltage ranges. Select a voltage range that is suitable for the input voltage. For details, see “1.4 Checking input power and the fuse.”

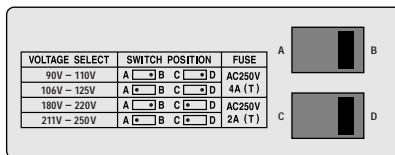

Fig. 5-10 Input voltage switch at the bottom of the PMR series

This chapter explains how to service and calibrate the PMR series. To ensure long-lasting high performance, maintain, inspect and calibrate the power supply on a regular basis. In addition, this chapter explains what to do when a problem occurs during operation.

6.1 Cleaning

If the equipment is dirty, wipe off dirt by lightly patting it with a cloth moistened with a neutral detergent diluted in water.

⚠ WARNING • Before cleaning, be sure to turn OFF the POWER switch and unplug the power cord.

⚠ CAUTION • Do not use volatile substances such as thinner or benzene. The application of such substances to the equipment can discolor its surface, erase printed characters, and cause the display to be blurry.

6.2 Inspection

Power Cord

Check for faults such as coating fractures, plug backlash, and cracks.

⚠ WARNING • Some faults such as coating fractures can cause electric shocks. If such faults are found, stop operation immediately.

To obtain accessories, contact Kikusui distributor/agent.

6.3 Calibration

Before shipment, the PMR series is thoroughly calibrated. After a extended periods of use, however, the power supply will require regular calibration.

To have calibration performed, you may contact Kikusui distributor/agent. If you wish to calibrate the power supply on your own, follow the steps below. The steps described cover all necessary calibration procedures.

6.3.1 Necessary equipment

For calibration, prepare the following measuring instruments:

- A DC voltmeter with an accuracy of at least 0.02% (DVM)
- A shunt resistor with an accuracy of at least 0.1% (with enough capacity to apply a rated output current for the PMR series to be calibrated).

Table 6-1 Recommended shunt resistor

MODEL	Shunt resistor	
	Rating	Accuracy
PMR18-2.5DU	5A/100mV (20m Ω)	At least 0.1%
PMR35-1.2DU	2A/100mV (50m Ω)	
PMR18-1.3TR	5A/100mV (50m Ω)	
PMR25-1TR		
PMR24-1QU	2A/100mV (50m Ω)	

6.3.2 Environment

Conduct calibration under the following ambient conditions.

- Ambient temperature: 23°C \pm 5°C
- Ambient humidity: 80% RH or less

To minimize calibration errors due to an initial drift, warm up the power supply for at least 30 minutes before starting calibration. Also warm up the DVM and shunt resistor for a necessary period of time.

6.3.3 Calibration mode

To perform calibration, it is necessary to switch the power supply to calibration mode.

While holding down the STORE switch, turn ON the POWER switch. The power supply will switch to calibration mode, and the following will be displayed after version information.

To exit calibration mode, turn OFF the POWER switch.

NOTE

- Keep pressing the STORE switch until “CAL” is displayed on the voltmeter.

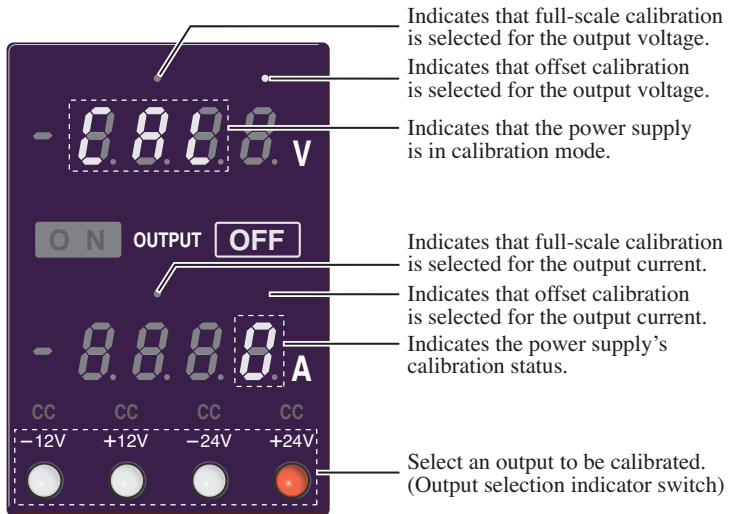

Fig. 6-1 Panel display for calibration modes

6.3.4 Calibration procedure

Calibration must be performed on four interrelated items:

- Output voltage offset
- Output voltage in full scale
- Output current offset
- Output current in full scale

Calibration of any output is possible. The output voltage or the output current can be calibrated independently. Be sure to perform both offset and full scale calibration.

Calibration status indicator

The progress status of calibration is displayed on the panel using numbers 0 through 3.

- 0: Calibration is started or complete.
- 1: Calibration of the output voltage (or current) offset is complete.
- 2: Calibration of the output voltage (or current) in full scale is complete.
- 3: Calibration is complete for both the full scale and offset of the output voltage (or current).

For the calibration of the output, perform both offset and full scale calibration of the voltage or current. To terminate the calibration, press the STORE switch in the calibration status in “3” above.

To exit the calibration mode, turn the POWER switch to OFF.

The voltage and current values for the calibrated output are reset to 0.

NOTE

- After the offset and full scale calibration of the voltage or current, be sure to press the STORE switch to terminate calibration. The calibrated values become invalid, if calibration is started for another output, or if the POWER switch is turned to OFF, before the STORE switch is pressed.
 - In the calibration mode, the power supply outputs the voltage or current that is used for offset and full scale calibration. This output value may differ from the one obtained previously. The value is close to 0 in offset calibration and around the rated output value in full scale calibration.
-

Voltage calibration procedure

■ Device connections

1. Turn OFF the POWER switch.
2. Connect the DVM to the output terminal to be calibrated. To calibrate the positive (+) output, see Fig. 6-2. To calibrate the negative (-) output, see Fig. 6-3. To calibrate 6 V output (for the PMR-TR type only), see Fig. 6-4.

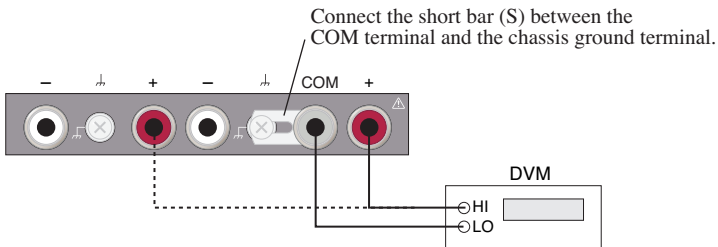

Fig. 6-2 Connections for voltage calibration (+ output)

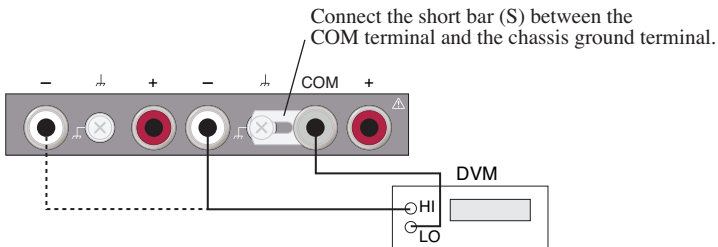

Fig. 6-3 Connections for voltage calibration (- output)

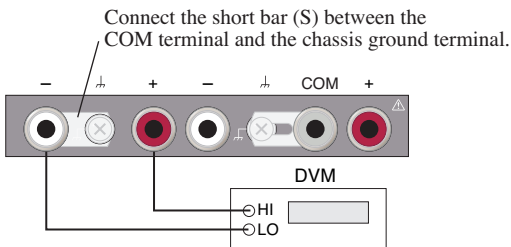

Fig. 6-4 Connections for voltage calibration (6 V output)
(for PMR-TR type only)

■ Warm-up

3. While holding down the STORE switch, turn on the POWER switch.
4. Make sure that “CAL” is displayed on the panel.
5. Fully warm up the devices, including the DVM.

● Output voltage offset

6. Using the Output Selection Indicator switch, select the output to be calibrated.
7. Using the VOLTAGE switch, select the output voltage offset calibration. (Fig. 6-1)
8. Turn ON the OUTPUT switch.
9. Turn the dial until the DVM reading is set to 0 V.
10. Turn OFF the OUTPUT switch.
11. The status indicator shifts from “0” to “1.”

● Output voltage in full scale

12. Using the VOLTAGE switch, select output voltage in full scale calibration. (Fig. 6-1)
13. Turn ON the OUTPUT switch.
14. Turn the dial until the DVM reading is set to the rated output voltage.
15. Turn OFF the OUTPUT switch.
16. The status indicator shifts from “1” to “3.”
17. Press the STORE switch.
18. The status indicator shifts from “3” to “-” and then to “0.”

The above steps complete voltage calibration.

Current calibration procedure

■ Device connections

1. Turn OFF the POWER switch.
2. Connect the shunt resistor and DVM to the output terminal to be calibrated. To calibrate the positive (+) output, see Fig. 6-5. To calibrate the negative (-) output, see Fig. 6-6. To calibrate 6 V output (for the PMR-TR type only), see Fig. 6-7.

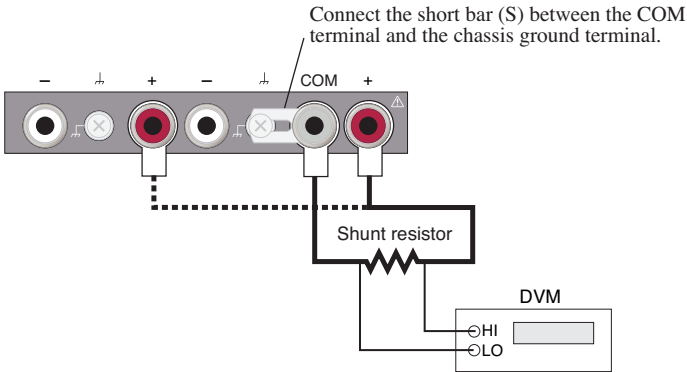

Fig. 6-5 Connections for current calibration (+ output)

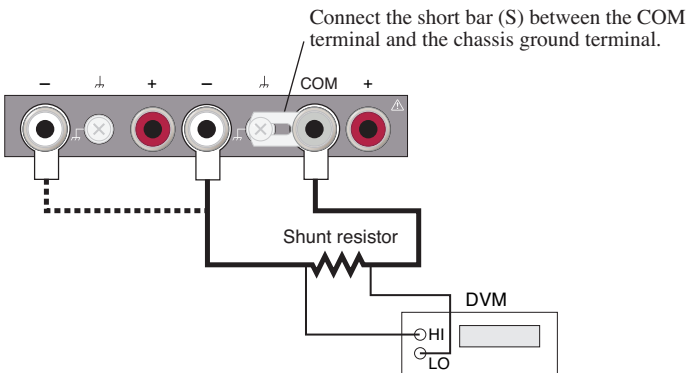

Fig. 6-6 Connections for current calibration (- output)

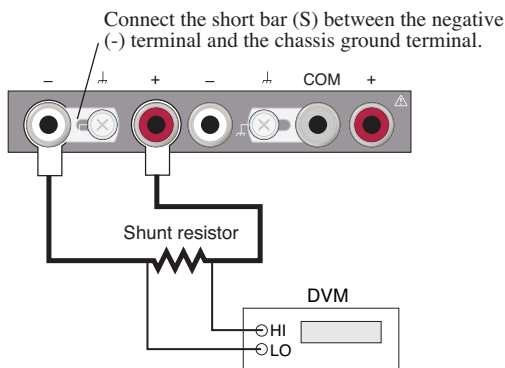

Fig. 6-7 Connections for current calibration (6 V output)
(for PMR-TR type only)

■ Warm-up

3. Turn ON the POWER switch.
4. Set the rated current for the output to be calibrated.
5. Turn ON the OUTPUT switch.
6. Fully warm up the devices, including the DVM and shunt resistor.
7. Turn OFF the POWER switch.
8. While holding down the STORE switch, turn ON the POWER switch.
9. Make sure that “CAL” is displayed on the panel.

● Output current offset

10. Using the Output Selection Indicator switch, select the output to be calibrated.
11. Using the CURRENT switch, select output current offset calibration. (Fig. 6-1)
12. Turn ON the OUTPUT switch.
13. Turn the dial until the DVM reading is set to 0 V.
14. Turn OFF the OUTPUT switch.
15. The status indicator shifts from “0” to “1.”

Current calibration procedure (continued)

● Output current in full scale

16. Using the CURRENT switch, select output current in full scale calibration. (Fig. 6-1)
17. Turn ON the OUTPUT switch.
18. Turn the dial until the current value calculated from the DVM reading is set to the rated output current.
19. Turn OFF the OUTPUT switch.
20. The status indicator shifts from “1” to “3.”
21. Press the STORE switch.
22. The status indicator shifts from “3” to “-” and then to “0.”

The above steps complete current calibration.

6.4 Malfunctions and causes

This section describes what to do if you have a problem during operation.

Most faults fall under one of the five types below. Identify the type of problem you have and follow instructions given.

If your problem persists after taking the suggested countermeasures or if it relates to none of the problems described, contact Kikusui distributor/agent.

■ Problem 1: Nothing appears on the display.

Check points	Causes and Countermeasures
<input type="checkbox"/> Is the power cord disconnected?	<ul style="list-style-type: none">• Replace with a new power cord.
<input type="checkbox"/> Is the fuse broken?	<ul style="list-style-type: none">• The input voltage is too high. Supply a voltage consistent with the input voltage range. See “ 1.4 Checking input power and the fuse” and replace the fuse. If the new fuse also fails, immediately stop operation and contact us for servicing.• After long periods of operation, the fuse is likely to have deteriorated due to rush currents. See “ 1.4 Checking input power and the fuse” and replace the fuse.
<input type="checkbox"/> Is the setting of the Input Voltage switch at the bottom of the power supply correctly?	<ul style="list-style-type: none">• See “ 1.4 Checking input power and the fuse” and set the line voltage correctly.

■ Problem 2: There is no output even when the OUTPUT switch is turned ON.

Check points	Causes and Countermeasures
<input type="checkbox"/> Are the voltage and current set to their minimum values?	<ul style="list-style-type: none"> • Correct the output settings.
<input type="checkbox"/> Is the OUTPUT ON LED off?	<ul style="list-style-type: none"> • The ON/OFF control terminals (terminals 17 and 18 on the J1 terminal board) are closed for output by an external contact. See “ 4.1.3 Output ON/OFF control using an external contact.”
<input type="checkbox"/> Is the OUTPUT CH SELECT switch set to EXTERNAL?	<ul style="list-style-type: none"> • The value set using the dial is not output if the OUTPUT CH SELECT switch is set to EXTERNAL. Reset the switch to INTERNAL.

■ Problem 3: Output ripples are too large.

Check points	Causes and Countermeasures
<input type="checkbox"/> Is the input voltage within the appropriate range?	<ul style="list-style-type: none"> • Supply a voltage compatible with the input voltage range.
<input type="checkbox"/> Are the output terminal and the chassis ground terminal floating?	<ul style="list-style-type: none"> • The terminals are affected by the power frequency (50/60 Hz). If possible, ground the output terminal using a capacitor of 0.1 μF or more.
<input type="checkbox"/> Is there a strong magnetic or electric field nearby?	<ul style="list-style-type: none"> • Electromagnetic induction is interfering with the power supply. Relocate the power supply far from the source, or twist the cable.
<input type="checkbox"/> When using external voltage control, is noise from the voltage too large?	<ul style="list-style-type: none"> • Take steps to prevent noise in accordance with “ 4.1.2 Controlling output voltages using an external voltage source.”

■ Problem 4: Err 16 is displayed.

Check points	Causes and Countermeasures
<input type="checkbox"/> Are devices with the same node address on the TP-BUS?	<ul style="list-style-type: none">• Turn off the POWER switch on the device for which Err 16 is displayed, and remove the device from the TP-BUS. Then set a different node address for the device. For the setting procedure, see the "Connecting & Programming Guide" in the CD-ROM that came with the PIA4800 series.

■ Problem 5: Err 08 is displayed.

Check points	Causes and Countermeasures
<input type="checkbox"/> Is the TP-BUS short-circuited?	<ul style="list-style-type: none">• The twisted-pair cable may be short-circuited near the connector. For detail of connection, see the "Connecting & Programming Guide" in the CD-ROM that came with the PIA4800 series.
<input type="checkbox"/> Was the POWER switch being turned to OFF when a node address was being changed?	<ul style="list-style-type: none">• An incorrect node address is set. For the setting procedure, see the "Connecting & Programming Guide" in the CD-ROM that came with the PIA4800 series.

This chapter provides the electrical and mechanical specifications for the PMR series, as well as a list of accessories.

7.1 Specifications

Unless otherwise specified, these specifications are based on the following conditions.

- Pure resistors are used as a load.
- The COM terminal is connected to the chassis ground terminal with the accompanying short bar. (With PMR-TR type, the negative (-) terminal for 6 V output is also connected to the chassis ground terminal using the short bar.)
- The ambient temperature is $23^{\circ}\text{C} \pm 5^{\circ}\text{C}$ and 80% RH, and the power supply has been warmed up for 30 minutes

TYP value does not guarantee performance. It should be referred to as target value only.

Output		PMR18-2.5DU	PMR35-1.2DU	PMR18-1.3TR	PMR25-1TR	PMR24-1QU
OUTPUT CH1	Output voltage	0 to +18V ±(0.15%+20mV)	0 to +35V ±(0.15%+20mV)	0 to +18V ±(0.15%+20mV)	0 to +25V ±(0.15%+20mV)	0 to +24V ±(0.15%+20mV)
	Output current	10mV 0 to 2.5A ±(0.3%+5mA)	10mV 0 to 1.2A ±(0.3%+5mA)	10mV 0 to 1.3A ±(0.3%+5mA)	10mV 0 to 1A ±(0.3%+5mA)	10mV 0 to 1A ±(0.3%+2mA)
		Resolution	1mA	1mA	1mA	1mA
		Range	0 to -18V	0 to -35V	0 to -18V	0 to -25V
OUTPUT CH2	Output voltage	±(0.15%+20mV)	±(0.15%+20mV)	±(0.15%+20mV)	±(0.15%+20mV)	±(0.15%+20mV)
	Output current	10mV 0 to -2.5A ±(0.3%+5mA)	10mV 0 to -1.2A ±(0.3%+5mA)	10mV 0 to -1.3A ±(0.3%+5mA)	10mV 0 to -1A ±(0.3%+5mA)	10mV 0 to -1A ±(0.3%+2mA)
		Resolution	1mA	1mA	1mA	1mA
		Range	0 to +6V	0 to +6V	0 to +6V	0 to +6V
OUTPUT CH3	Output voltage	—	—	±(0.2%+5mV)	±(0.2%+5mV)	±(0.15%+20mV)
	Output current	—	—	1mV 0 to 5A ±(0.4%+5mA)	1mV 0 to 5A ±(0.4%+5mA)	10mV 0 to -1.5A ±(0.3%+5mA)
		Resolution	—	—	1mA	1mA
		Range	—	—	1mA	1mA

		PMR18-2.5DU	PMR35-1.2DU	PMR18-1.3TR	PMR25-1TR	PMR24-1QU
Output (Cont.)						
OUTPUT CH4	Output voltage	—	—	—	—	0 to -12V
	Range Setting accuracy*1	—	—	—	—	±(0.15%+20mV)
	Resolution	—	—	—	—	10mV
	Output current	—	—	—	—	0 to -1.5A
	Range Setting accuracy*1	—	—	—	—	±(0.3%+5mA)
Tracking operation	Resolution	—	—	—	—	1mA
	Outputs compatible	OUTPUT CH1 and OUTPUT CH2				
	Operating range	0 to 200% (for the output at the startup of tracking operations) *2				
	Error voltage*1	±(0.4%+40mV)				
	Error current*1	±(0.7%+10mA)				

*1: For panel settings and remote control settings. Error against a setting value.

*2: Ceases to change once either OUTPUT 1 or OUTPUT 2 reaches the rated voltage.

		PMR18-2.5DU	PMR35-1.2DU	PMR18-1.3TR	PMR25-1TR	PMR24-1QU
Constant-voltage characteristics						
Source effect (against $\pm 10\%$ of the line voltage)	OUTPUT CH1	Within $\pm 1\text{mV}$	Within $\pm 2\text{mV}$	Within $\pm 2\text{mV}$	Within $\pm 2\text{mV}$	Within $\pm 2\text{mV}$
	OUTPUT CH2	Within $\pm 1\text{mV}$	Within $\pm 2\text{mV}$	Within $\pm 2\text{mV}$	Within $\pm 2\text{mV}$	Within $\pm 2\text{mV}$
	OUTPUT CH3	—	—	Within $\pm 2\text{mV}$	Within $\pm 2\text{mV}$	Within $\pm 1\text{mV}$
	OUTPUT CH4	—	—	—	—	Within $\pm 1\text{mV}$
Load effect (against 0% to 100% of the output current)	OUTPUT CH1	Within $\pm 2\text{mV}$	Within $\pm 2\text{mV}$	Within $\pm 2\text{mV}$	Within $\pm 2\text{mV}$	Within $\pm 2\text{mV}$
	OUTPUT CH2	Within $\pm 2\text{mV}$	Within $\pm 2\text{mV}$	Within $\pm 2\text{mV}$	Within $\pm 2\text{mV}$	Within $\pm 2\text{mV}$
	OUTPUT CH3	—	—	Within $\pm 5\text{mV}$	Within $\pm 5\text{mV}$	Within $\pm 2\text{mV}$
	OUTPUT CH4	—	—	—	—	Within $\pm 2\text{mV}$
Ripple and noise (5Hz to 1MHz)	OUTPUT CH1	0.5mVrms or less	0.5mVrms or less	0.5mVrms or less	0.5mVrms or less	0.5mVrms or less
	OUTPUT CH2	0.5mVrms or less	0.5mVrms or less	0.5mVrms or less	0.5mVrms or less	0.5mVrms or less
	OUTPUT CH3	—	—	0.5mVrms or less	0.5mVrms or less	0.5mVrms or less
	OUTPUT CH4	—	—	—	—	0.5mVrms or less
Transient response*3 (TYP value)	OUTPUT CH1	50 μs	50 μs	50 μs	50 μs	50 μs
	OUTPUT CH2	50 μs	50 μs	50 μs	50 μs	50 μs
	OUTPUT CH3	—	—	50 μs	50 μs	50 μs
	OUTPUT CH4	—	—	—	—	50 μs
Temperature coefficient	All outputs	100ppm/ $^{\circ}\text{C}$ or less				

*3: Time taken by the output voltage to return to the rated value $\pm (0.05\% + 10 \text{ mV})$ while the output current fluctuates 10% to 100%.

		PMR18-2.5DU	PMR35-1.2DU	PMR18-1.3TR	PMR25-1TR	PMR24-1QU	
Constant-current characteristics							
Source effect (against $\pm 10\%$ of the line voltage)	OUTPUT CH1	Within $\pm 2\text{mA}$	Within $\pm 2\text{mA}$	Within $\pm 2\text{mA}$	Within $\pm 2\text{mA}$	Within $\pm 2\text{mA}$	
	OUTPUT CH2	Within $\pm 2\text{mA}$	Within $\pm 2\text{mA}$	Within $\pm 2\text{mA}$	Within $\pm 2\text{mA}$	Within $\pm 2\text{mA}$	
	OUTPUT CH3	—	—	Within $\pm 4\text{mA}$	Within $\pm 4\text{mA}$	Within $\pm 2\text{mA}$	
	OUTPUT CH4	—	—	—	—	Within $\pm 2\text{mA}$	
	Load effect (output short-circuit to 100% of the output voltage)	OUTPUT CH1	Within $\pm 5\text{mA}$	Within $\pm 5\text{mA}$	Within $\pm 5\text{mA}$	Within $\pm 5\text{mA}$	Within $\pm 5\text{mA}$
		OUTPUT CH2	Within $\pm 5\text{mA}$	Within $\pm 5\text{mA}$	Within $\pm 5\text{mA}$	Within $\pm 5\text{mA}$	Within $\pm 5\text{mA}$
		OUTPUT CH3	—	—	Within $\pm 10\text{mA}$	Within $\pm 10\text{mA}$	Within $\pm 5\text{mA}$
		OUTPUT CH4	—	—	—	—	Within $\pm 5\text{mA}$
Ripple and noise (5Hz to 1MHz)	OUTPUT CH1	1.5mA Arms or less	1.5mA Arms or less	1.5mA Arms or less	1.5mA Arms or less	1.5mA Arms or less	
	OUTPUT CH2	1.5mA Arms or less	1.5mA Arms or less	1.5mA Arms or less	1.5mA Arms or less	1.5mA Arms or less	
	OUTPUT CH3	—	—	4mA Arms or less	4mA Arms or less	1.5mA Arms or less	
	OUTPUT CH4	—	—	—	—	1.5mA Arms or less	
Temperature coefficient	300ppm/ $^{\circ}\text{C}$ or less						
Voltmeter	All outputs						
	Accuracy	$\pm(0.2\% \text{rdg} + 20\text{mV})$	$\pm(0.2\% \text{rdg} + 20\text{mV})$	$\pm(0.2\% \text{rdg} + 20\text{mV})$ (OUTPUT CH1&2) $\pm(0.3\% \text{rdg} + 5\text{mV})$ (OUTPUT CH3)	$\pm(0.2\% \text{rdg} + 20\text{mV})$ (OUTPUT CH1&2)	$\pm(0.2\% \text{rdg} + 20\text{mV})$	
Ammeter	Resolution	10mV	10mV	10mV (OUTPUT CH1&2) 1mV (OUTPUT CH3)	10mV (OUTPUT CH1&2) 1mV (OUTPUT CH3)	10mV	
	Accuracy	$\pm(0.5\% \text{rdg} + 5\text{mA})$	$\pm(0.5\% \text{rdg} + 5\text{mA})$	$\pm(0.5\% \text{rdg} + 5\text{mA})$ (OUTPUT CH1&2) $\pm(0.5\% \text{rdg} + 10\text{mA})$ (OUTPUT CH3)	$\pm(0.5\% \text{rdg} + 5\text{mA})$ (OUTPUT CH1&2)	$\pm(0.5\% \text{rdg} + 5\text{mA})$	
Indicator	Resolution	1mA	1mA	1mA	1mA	1mA	
	CC lamp	Red LED					
OHP lamp	Indicated using a seven-segment LED						
OUTPUT ON lamp	Green LED						
OUTPUT OFF lamp	Green LED						

	PMR18-2.5DU	PMR35-1.2DU	PMR18-1.3TR	PMR25-1TR	PMR24-1QU
Protection					
Overheat protection	Approx. 95°C (with a heat sink)				
Output fuse	3A	1.5A	1.5A (OUTPUT CH1&2) 7A (OUTPUT CH3)	1.5A (OUTPUT CH1&2) 2A (OUTPUT CH3&4)	
Thermal fuse	126°C				
Input fuse	4A(T) (at 90-125V) / 2A(T) (at 180-250V)				
OUTPUT ON/OFF	All outputs are turned ON/OFF simultaneously.				
Tracking operation ON/OFF	Operable				
Memory function	Three setting statuses are stored. (Voltage and current set for all outputs)				
POWER ON OUTPUT ON function	Starts up with outputs ON when the power is turned ON.				
Lock function	The front panel switches and dial, or the dial function is inactivated.				
OHP alarm signal output	Outputs with a photocoupler V _{CEO} : 80 V, I _C : 50 mA, P _C : 150 mW				
Grounding	Positive, COM, and negative grounding possible				
Common	Common to all outputs	Common to all outputs	Common to OUTPUT CH1 and OUTPUT CH2 OUTPUT 3 independent	Common to all outputs	Common to all outputs
Isolation voltage	Withstanding voltage 30 VDC ±250VDC				
Insulation resistance					
Between the primary input and the chassis	30 MΩ or more at 500 VDC				
Between the primary input and each output	30 MΩ or more at 500 VDC				
Between each output and the chassis	20 MΩ or more at 500 VDC				

	PMR18-2.5DU	PMR35-1.2DU	PMR18-1.3TR	PMR25-1TR	PMR24-1QU
Withstanding voltage					
Between the primary input and the chassis		1.5 kVAC, No abnormality for one minute			
Between the primary input and each output		1.5 kVAC, No abnormality for one minute			
Installation location		Indoors and altitude of up to 2000 m			
Operating temperature and humidity		0°C to +40°C (+32°F to +104°F), 10 to 80%RH (No dew condensation)			
Storage temperature and humidit		-10°C to +60°C (+14°F to +140°F), 90%RH or less (No dew condensation)			
Cooling system		Forced air cooling			
Weight		Approx. 6.5 kg (14.33 lbs)			
Dimensions	See Fig. 7-1.		See Fig. 7-2.		See Fig. 7-3.
Accessory					
Output terminal cover		1 piece (including mounting screw (M4 x 16): 2 pieces, washer: 1 piece)			
Short bar (L)		1 piece			
Fuse		(4 A(T): 1 piece, 2 A(T): 2 pieces) or (4 A(T): 2 pieces, 2 A(T): 1 piece)*4			
TP-BUS connector		1 piece			
TP-BUS core		1 piece			
Operation manual		1 copy			
AC power cord		1 piece			
Power requirement	Voltage	90V-110V (1 ϕ), 106V-125V (1 ϕ), 180V-220V (1 ϕ), or 211V-250V (1 ϕ)			
		Selectable using the switch at the bottom			
	Frequency	50/60Hz			
Power consumption		Max. 320 VA			

Analog remote control		PMR18-2.5DU	PMR35-1.2DU	PMR18-1.3TR	PMR25-1TR	PMR24-1QU
Output voltage control by voltage		Maximum control input voltage: Less than 11 V				
Output voltage/ control voltage	OUTPUT CH1	+18V/approx.10V	+35V/approx. 10V	+18V/approx.10V	+25V/approx.10V	+24V/approx.10V
	OUTPUT CH2	-18V/approx. 10V	-35V/approx.10V	-18V/approx.10V	-25V/approx. 10V	-24V/approx.10V
	OUTPUT CH3	—	—	6V/approx. 10V	6V/approx. 10V	+12V/approx.10V
	OUTPUT CH4	—	—	—	—	-12V/approx.10V
Output voltage response time		Rise time*5: 0.8 s or less, Fall time*6: 0.8 s or less				
Turning outputs ON/OFF using a contact		All outputs are turned ON/OFF simultaneously. Open circuit voltage: 5 V, short-circuit current: 0.5 mA (pulled up from +5 V with 10 kW), CMOS input				
Calling values up from memory using a contact		MEMORY 1, 2, and 3 are called. Open circuit voltage: 5 V, short-circuit current: 0.5 mA (pulled up from +5 V with 10 kW), CMOS input Controlled by the PIA4800-series power supply controller				
Digital remote control		Controlled by the PIA4800-series power supply controller				
Digital control terminal		2P connector, nonpolar, connected using the accompanying TP-BUS connector				
TP-BUS		Up to 31 units connectable on the bus, total length: 200 m or less, using a twisted-pair cable				
Output voltage response time		Rise time*7: 0.85 s or less, Fall time*8: 0.85 s or less				

*5: Time required for the output voltage of the power supply to rise from 0 V to 90% of the rated voltage after the application of a control voltage.

*6: Time required for the output voltage of the power supply to fall by 90% of the rated voltage after the application of a control voltage.

*7: Time required for the output voltage of the power supply to rise from 0 V to 90% of the rated voltage after a VSET message is received by the power supply controller.

*8: Time required for the output voltage of the power supply to fall by 90% of the rated voltage after a VSET message is received by the power supply controller.

	PMR18-2.5DU	PMR35-1.2DU	PMR18-1.3TR	PMR25-1TR	PMR24-1QU
Safety (*9, *10)	Conforms to the requirements of the following directive and standard. Low Voltage Directive 2006/95/EC EN 61010-1 Class I Pollution degree 2				
Electromagnetic compatibility (EMC) (*9)	Conforms to the requirements of the following directive and standard. EMC Directive 2004/108/EC EN 61326-1 EN 61000-3-2 EN 61000-3-3				

*9: Only on models that have CE marking on the panel.

Not applicable to custom order models.

*10: This unit is a Class I equipment. Be sure to ground the protective conductor terminal of the unit. The safety of the unit is not guaranteed unless the unit is grounded properly.

7.2 Dimensional drawings

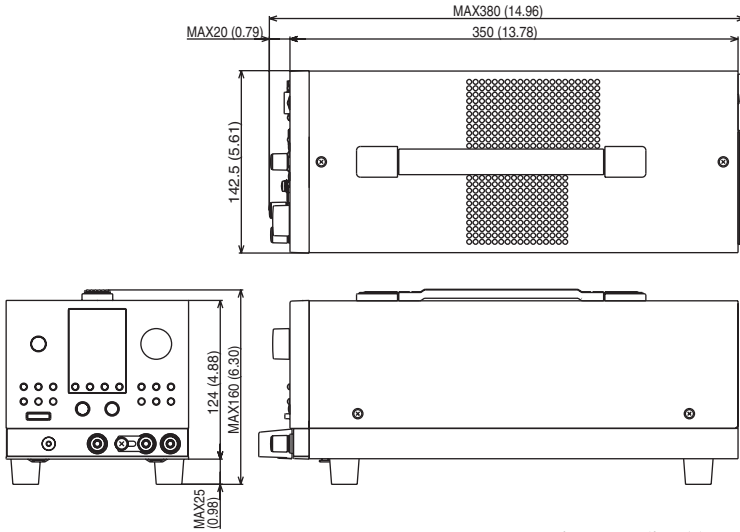

Unit: mm (inch)

Fig. 7-1 External dimensions of the PMR-DU type

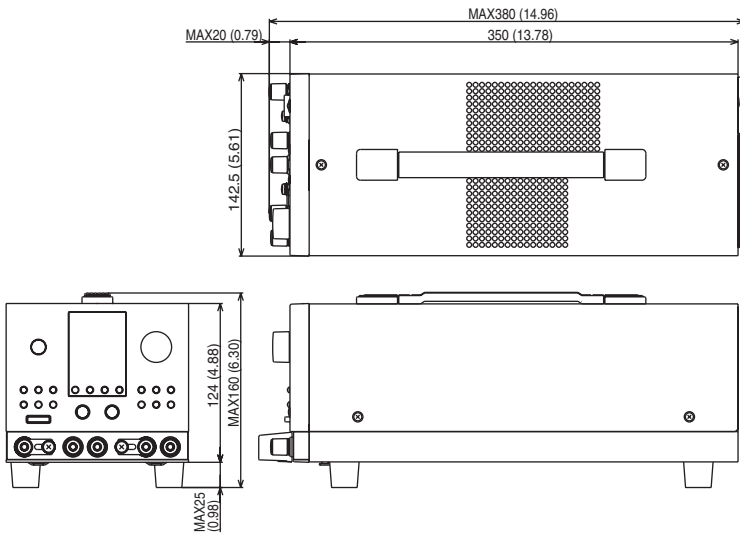

Unit: mm (inch)

Fig. 7-2 External dimensions of the PMR-TR type

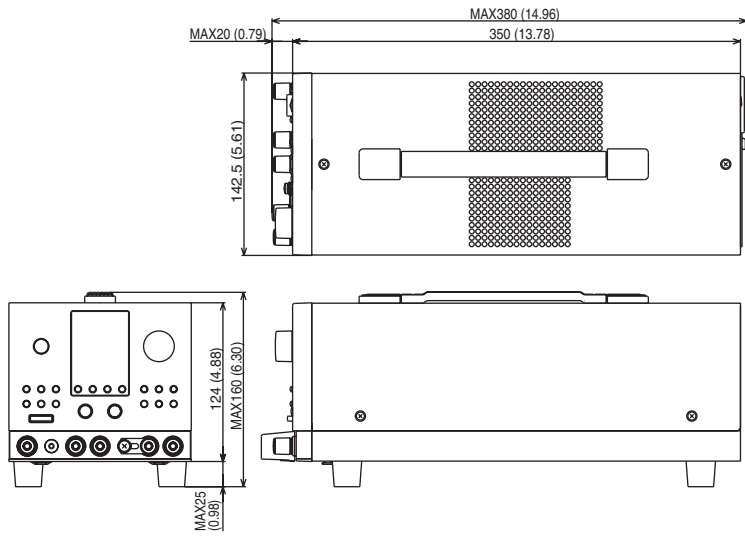

Unit: mm (inch)

Fig. 7-3 External dimensions of the PMR-QU type

Index

A

- AC INPUT connector 5-9
- AC power cord 1-8
- Accessories 1-2
- Ammeter 5-5
- Analog remote control 4-2
- Anti-polar voltage 2-1

C

- Calibration 6-2
- CC 2-6
- Channel number 2-8
- Chassis ground terminal 5-7
- Cleaning 6-1
- COARSE 3-3
- COM terminal 5-6
- Constant-current indicator 5-5
- Constant-current power supply 2-5, 3-9
- Constant-voltage power supply 2-5, 3-8
- CURRENT COARSE/FINE switch 5-4
- CV 2-5

D

- Dial 5-3
- DIAL/KEY LOCK switch 5-3
- Digital remote control 4-16

F

- FINE 3-3
- fuse 1-6
- Fuse holder 1-7, 5-10

G

- Grounding 1-10

I

- incorporation into a rack P-2
- input power 1-6
- Input voltage switch 1-7, 5-10
- Inrush current 2-1
- Inspection 6-1
- Installation 1-3

J

- J1 terminal board 4-2, 5-9

L

- Load 2-2
- Load connections 3-10
- LOCK switch 3-25

M

- Malfunctions 6-11
- Memory 3-16
- MEMORY switch 5-3
- MODE switch 3-24, 5-9

N

- NODE ADRS switch 5-3

O

OHP 2-7

OUTPUT ADJUST variable
resistor 5-8

OUTPUT CH No. 2-8, 5-7

Output ON/OFF control by
external contact 4-12

OUTPUT ON/OFF indicator 5-5

OUTPUT SELECT switch 5-8

Output selection indicator
switch 5-5

Output settings 3-3

OUTPUT switch 5-3

Output terminal cover 2-9

Output voltage control by external
voltage 4-6

Overheat protection 2-7

P

Parallel operation 3-18

POWER switch 5-3

PWR ON OUTPUT switch 3-24

R

Recall of Memories 1, 2, and 3 by
external contact 4-14

Remote control 4-1

ROM version 3-2

S

Serial operation 3-18

SET switch 5-3

Settings at the time of
shipment 3-7

Short bar 5-7

STORE switch 5-4

Switchboard 1-9

T

TERMN switch 5-9

TP-BUS terminal 5-9

TRACK switch 5-3

Tracking 3-12

Turning on the power 3-1

V

VOLTAGE COARSE/FINE
switch 5-4

Voltmeter 5-5