

# User's Manual

PLZ-4WH Series Electronic Load

**PLZ164WH**  
**PLZ334WH**  
**PLZ1004WH**

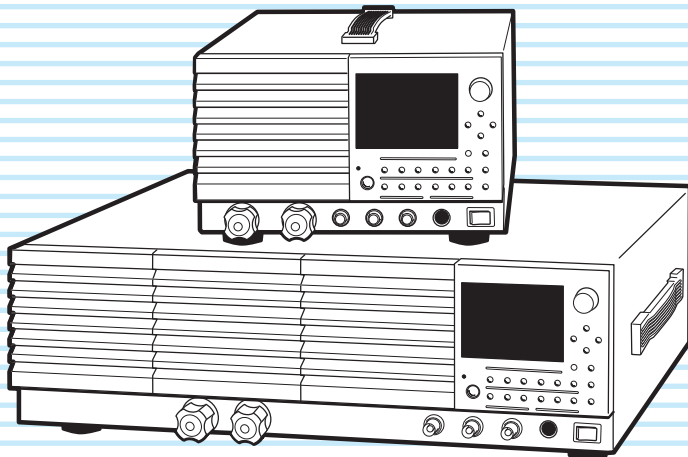

Installation and  
Preparation

1

Basic Functions

2

Advanced Operations

3

Sequences

4

External Control and  
Master-Slave Control

5

Maintenance

6

Specifications

7

App

## About PLZ-4WH Series Manual

This manual is intended for users of the product or persons teaching other users on how to operate the product.

The manual assumes that the reader has knowledge about Power Supply.

- User's manual (this manual)  
User's manual is intended for first-time users of the PLZ-4WH series. It gives an overview of the PLZ-4WH series and describes various settings, measurement procedures, maintenance, safety precautions, etc.  
This manual is designed to be read from beginning to end. You can review this manual when you are confused about an operation or when a problem occurs.
- The communication interface manual  
The communication interface manual describes the content of the commands.  
The interface manual is written for readers with sufficient basic knowledge of how to control instruments using a personal computer.
- Quick Reference  
The quick reference briefly explains the panel description and the basic operation of the PLZ-4WH.
- Setup Guide  
The setup guide is intended for first-time users of the PLZ-4WH series. It gives an overview of the PLZ-4WH series, connecting procedures, safety precautions, etc. Please read through and understand this guide before operating the product.

PDF and HTML files are included in the accompanying CDROM. Adobe Reader 9.2 or later is required to view the PDF files. Microsoft Internet Explorer 9 or later is required to view the HTML files.

If you find any incorrectly arranged or missing pages in the manual, they will be replaced. If the manual gets lost or soiled, a new copy can be provided for a fee. In either case, please contact Kikusui distributor/agent, and provide the "Kikusui Part No." given on the cover.

The Operation Manual has been prepared with the utmost care; however, if you have any questions, or note any errors or omissions, please contact Kikusui distributor/agent.

## Product ROM versions that this manual covers

This manual applies to products with firmware versions 1.0X.

When contacting us about the product, please provide us with:

The model (marked in the top section of the front panel)

The ROM version (see page 16)

The serial number (marked in the rear panel)

## Trademark acknowledgements

Microsoft and Windows are either registered trademarks or trademarks of Microsoft Corporation in the United States and/or other countries.

Other company names and product names used in this manual are generally trademarks or registered trademarks of the respective companies.

## Copyrights

Reproduction and reprinting of operation manual, whole or partially, without our permission is prohibited.

Both unit specifications and manual contents are subject to change without notice.

© 2011 Kikusui Electronics Corporation

## Notations used in this manual

- The PLZ164WH Electronic Load is also referred to as the PLZ164WH, the PLZ334WH Electronic Load is also referred to as the PLZ334WH, the PLZ1004WH Electronic Load is also referred to as the PLZ1004WH.
- The word computer used in the text is a collective term for personal computers and workstations.
- The following markings are used in this manual.

### WARNING

Indicates a potentially hazardous situation which, if ignored, could result in death or serious injury.

### CAUTION

Indicates a potentially hazardous situation which, if ignored, may result in damage to the product or other property.

### NOTE

Indicates information that you should know.

### DESCRIPTION

Explanation of terminology or operation principle.

### See

Indicates reference to detailed information.

### >

Indicates menu settings that you select. The menu item to the left of the > symbol is a higher level menu.

### SHIFT+key name

Indicates an operation that requires you to press a key indicated in blue letters while holding down SHIFT.

### Memo

Indicates useful information.

- This product is IEC Safety Class I equipment (equipment with a protective conductor terminal). To prevent electric shock, be sure to connect the protective conductor terminal of the product to electrical ground (safety ground).

## Product Overview

The PLZ-4WH Series Electronic Load is a multifunctional system designed to offer the highest levels of reliability and safety. The electronic load contains a stable and high-performance current-control circuit that enables high-speed load simulations. In addition, its CPU control feature works to improve operability and multifunctional capability.

The high-precision current settings provide you with sufficient resolution.

Because the electronic load comes standard with GPIB, RS232C, and USB communication functions, it can be easily incorporated into a wide range of test and inspection systems.

### PLZ-4WH Series Models

Model	Maximum Operating Current	Operating Voltage	Power
PLZ164WH	8.25 A	5 V to 650 V	165 W
PLZ334WH	16.5 A	5 V to 650 V	330 W
PLZ1004WH	50 A	5 V to 650 V	1000 W
PLZ4004WHB <sup>1</sup>	100 A	5 V to 650 V	2000 W

<sup>1</sup>: PLZ2004WB is a dedicated option for PLZ1004WH.

## Features

In addition to the high-performance constant-current, constant-resistance, constant-voltage, and constant-power modes, the PLZ-4WH Series Electronic Load offers a wide variety of other features.

### High-speed slew rate

The rise and fall slew rate of the current when the PLZ-4WH switches at 2 % to 100 % (20 % to 100 % in M range) of the rated current in constant current mode is 0.8 A/μs (PLZ1004WH), which corresponds to fast rise and fall times of 50 μs (for all types).

This allows you to conduct accurate transient-response tests of DC power supplies and to accurately generate simulated waveforms for use as dummy loads.

In constant current mode, the PLZ-4WH allows configuration using slew rates (A/μs).

This allows you to optimize the voltage drop caused by the wire inductance that occurs when a load is switched or to optimize the transient control of the equipment under test (such as a constant-voltage power supply).

### Higher precision

Higher precision is offered for current settings.

High resolution for minute current settings is provided using a 3-range configuration. (0.003 mA resolution is possible in the L range of the PLZ164WH.)

### Operability

The PLZ-4WH employs a large LCD.

Measured values of voltage, current, and power at the load input terminals are indicated at all times. The values are indicated using larger characters than other sections to improve visibility.

Coarse and fine adjustments using the rotary knob are useful for setting values over a wide range.

The easy-to-use memory function enables repetitive tests.

### Sequence function

User-defined sequence patterns can be saved to the internal memory.

Up to 10 normal sequence programs and 1 fast sequence program can be saved. Normal sequences can contain up to 256 steps, and the fast sequence can contain up to 1024 steps.

You can edit sequences easily from the large LCD.

## Functions that are useful for battery discharge testing

You can measure the time from when the load is turned on until when it is turned off.

You can measure the time from the start of battery discharge to the cutoff voltage (time measurement) by using this function in conjunction with undervoltage protection (UVP).

In voltage measurement, the voltage immediately before the load turns off is measured. If you use the timer so that the load turns off after a specified amount of time, you can measure the closed-circuit voltage after a specified time has elapsed since the start of battery discharge (voltage measurement).

## Load booster

To achieve large capacity at low cost, the PLZ1004WH comes with a load booster (PLZ2004WHB).

Using a single PLZ1004WH as a master unit, up to four load boosters can be connected in parallel (9 kW, 450 A maximum).

## Standard-equipped GPIB, RS232C, and USB interfaces

The PLZ-4WH comes standard-equipped with GPIB, RS232C, and USB interfaces. It can be easily incorporated into a wide range of test and inspection systems.

When the interfaces are used with the sequence function, a variety of systems can be created.

## What Is an Electronic Load?

To measure the characteristics of power sources and other devices that produce energy, a load is required to consume the energy. A variable resistor can be used as a simple load. A device in which semiconductor devices such as transistors are used instead of a variable resistor is referred to as an "electronic load." Using semiconductor components, an "electronic load" can change the current and voltage freely, so when it is used with a control circuit, it can function as a variety of different types of loads.

Electronic loads can be used as loads for different types of circuits, for switching power supplies and other types of DC power supplies, for testing the characteristics and lifespans of primary and secondary batteries, and for aging. You can use the sequence function to create programs that simulate real load conditions and use these programs to produce varying loads in tests on devices such as power supplies for printers.

There are AC electronic loads and DC electronic loads. The PLZ-4WH is a DC electronic load for use with DC circuits.

## Basic Operation Modes

The following six operation modes are available on the PLZ-4WH.

1. Constant current mode (CC mode)
2. Constant resistance mode (CR mode)
3. Constant power mode (CP mode)
4. Constant voltage mode (CV mode)
5. Constant current and constant voltage mode (CC+CV mode)
6. Constant resistance and constant voltage mode (CR+CV mode)

Here, we will explain the simplest of the six modes: constant current (CC) mode.

### ■ Constant Current Mode Operation

In constant current (CC) mode, the PLZ-4WH operates as a constant-current load.

The PLZ-4WH sinks the specified current ( $I$ ) regardless of the output voltage ( $V1$ ) of the constant-voltage power supply.

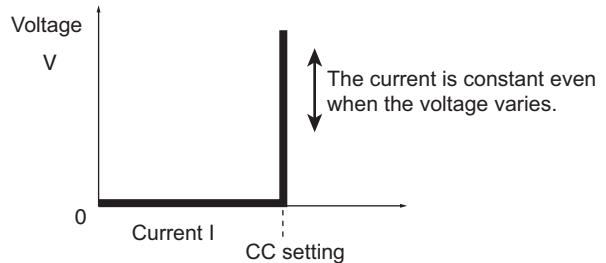
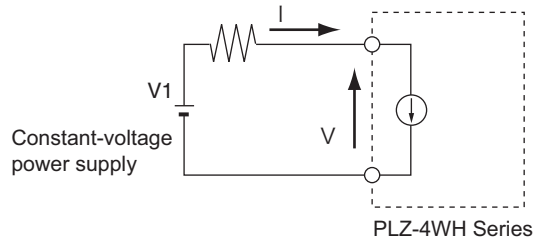

## Operating Areas of the PLZ-4WH

As shown in the figure, the PLZ-4WH can be used within the area enclosed by the constant voltage line defined by the rated voltage, the constant power line defined by the rated power, the constant current line defined by the rated current, and the constant voltage line defined by the minimum operating voltage (the enclosed area is where specifications are guaranteed).

The specifications are not guaranteed for input voltages below 5 V (the values in the actual operating area). The minimum operating voltage at which current begins to flow through the PLZ-4WH is approximately 0.5 V. If the input voltage is gradually increased from 0 V, no current will flow until this minimum operating voltage is exceeded. If the input voltage exceeds the minimum operating voltage and a current greater than or equal to 1 % of the range rating (greater than or equal to 1 % of the H range when the PLZ-4WH is set using the M range) starts flowing, the current can keep flowing even when the voltage is reduced down.

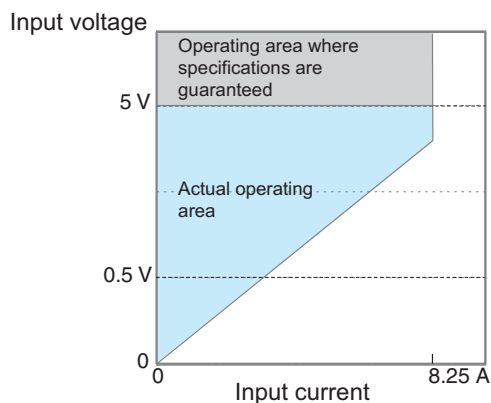
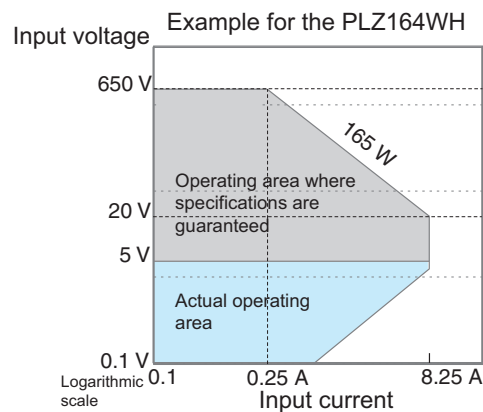

# Contents

- About PLZ-4WH Series Manual 2
- Notations used in this manual 3
- Product Overview 3
- What Is an Electronic Load? 4

## 1 Installation and Preparation

- Checking the Package Contents 12
- Attachment to the rack adapter 13
- Connecting the Power Cord 14
- Turning the Power On 15
  - Turning the POWER switch on 15
  - When the PLZ-4WH does not start properly 16
  - Checking the version 16
  - Turning the POWER switch Off 16
- Load wiring 17
- Methods for Ensuring Stable Operation 18
  - Reducing the load wiring inductance 18
  - Optimizing the response speed 19
  - Do not apply excessive voltages to the load input terminals 20
  - Match the polarities of the load input terminals and the DUT terminals 20
- Connecting to the Load Input Terminals 21
  - Connecting to the load input terminals on the rear panel 21
  - Connecting to the load input terminals on the front panel 24
- Remote Sensing 25

## 2 Basic Functions

- Panel Operation Basics 28
- Turning the Load On and Off 29
  - Turning the load on 29
  - Turning the load off 30
- Operation Modes 31
- Constant Current Mode (CC mode) 32
  - Configuring CC mode 32
  - Configuring CC+CV mode 33
- Constant Resistance Mode (CR) 34
  - Configuring CR mode 34
  - Configuring CR+CV mode 35
- Constant Voltage Mode (CV mode) 36
  - Configuring CV mode 36
- Constant Power Mode (CP mode) 37
  - Configuring CP mode 37
- Switching 38
  - Setting the switching level 38
  - Setting the switching interval 39
  - Turning the switching function on and off 39

- Slew Rate 40
  - Setting procedure 40
- Soft Start 41
- Short 42
  - Turning the short function on and off 42
- Locking the Keys 43
- Switching from Remote Mode to Local Mode 44

## 3 Advanced Operations

- Memory Types 46
- ABC Preset Memory 47
  - Saving settings to ABC preset memory 47
  - Recalling ABC preset memory entries 48
- Setup Memory 49
  - Saving settings to setup memory 49
  - Recalling setup memory entries 50
- Protection Functions 51
  - Protection function types 51
  - Clearing alarms 53
- Response Speed 54
- Elapsed Time Display and Auto Load-Off Timer 55
  - Elapsed time display (Count Time) 55
  - Auto load-off timer (Cut Off Time) 55
- Menu 56
- Factory Default Settings (Initialization) 58

## 4 Sequences

- Sequence Function 60
  - Normal sequences and fast sequences 60
- Common Sequence Editing Operations 61
- How Normal Sequences Work 62
- Editing Steps in a Normal Sequence 64
  - Adding steps 64
  - Editing steps 64
  - Deleting steps 65
- Sequence Example (Normal Sequence) 66
  - Editing program 1 67
  - Setting the steps of program 1 68
  - Editing program 2 70
  - Setting the steps of program 2 71
- How Fast Sequences Work 72
  - Editing steps 74
- Sequence Example (Fast Sequence) 76
  - Editing program 11 77
  - Setting the steps of program 11 78
- Executing, Pausing, and Stopping Sequences 79
  - Executing sequences 79
  - Pausing a sequence 79
  - Stopping a sequence 80
  - When sequences cannot be executed 80

## 5 External Control and Parallel Operation

- External Control 82
  - Precautions for high-speed load simulations 83
  - About the EXT CONT connector 84
  - EXT CONT connector pin arrangement 85
  - Control using an external voltage 86
  - Control using an external resistance 87
  - Control using an external voltage 88
  - Control using an external resistance 89
  - Control using an external voltage 90
  - Control using an external resistance 91
  - Control using an external voltage 92
  - Control using an external resistance 94
- Turning the Load On and Off through External Control 96
  - Signal Input for turning the load on and off 96
  - Load-on status signal output 96
- Using a Trigger Signal to Control the PLZ-4WH 97
- Controlling the Current Range Externally 98
  - Input for switching the range externally 98
  - Range status output 98
- Alarm Signal 99
  - Alarm input 99
  - Alarm status output 99
- Monitor Signal Output 100
  - Trigger signal output 100
  - Current monitor output 100
  - Voltage monitor output 101
- Parallel Operation 102
- Performing Parallel Operation 105
  - Turning the power on and off 105
  - Alarms during parallel operation 105
  - Ending parallel operation 106

## 6 Maintenance

- Inspection 108
  - Internal inspection 109
  - Backup battery replacement 109
- Calibration 110
  - What gets calibrated? 110
  - Preparation 111
- CC Mode Calibration (Calibration numbers 1, 2, and 3) 112
- CV Mode Calibration (Calibration numbers 4 and 5) 114
- Ending Calibration 116
- Troubleshooting 117

## 7 Specifications

- Ratings 120
  - Constant current (CC) mode 120
  - Constant resistance (CR) mode 121
  - Constant voltage (CV) mode 121
  - Constant (CP) power mode 122
- Measurements 122
- Switching mode 123
- Slew rate 123
- Soft start 124
- Response speed 124
- Remote sensing 124
- Protection function 124
- Sequence function 125
- Other functions 125
- Common specifications 126
- General specifications 127
- Dimensions 128

## Appendix

### A Operating Area 130

- Basic operation modes 130
- How constant current (CC) mode works 131
- How constant resistance (CR) mode works 132
- How constant power (CP) mode works 134
- How constant voltage (CV) mode works 136
- How constant current and constant voltage (CC+CV) mode works 138
- How constant resistance and constant voltage (CR+CV) mode works 140
- Operating areas of each model 142

### B Sequence Program Creation Table 145

### C Options 147

## INDEX 149

# Search by Topic

## Preparation

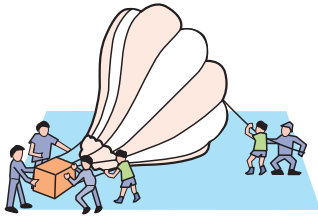

- What accessories are included in the package? → "Checking the Package Contents" p. 12

---

- The installation space is limited, so I want to check the installation conditions. → See the included "Setup Guide" document, or the electronic version of the document on the CD-R. ---

---

- How do I connect the AC power supply? → "Connecting the Power Cord" p. 14

---

- What kind of load wiring should I use? → "Load wiring" p. 17

---

- How do I set the communication conditions for remote control? → See the "Communication Interface Manual" on the CD-R. ---

---

- How do I rack mount the PLZ-4WH? What kind of parts are needed? → "Attachment to the rack adapter" p. 13

## Setup



- I want to use the PLZ-4WH in CC mode. → "Constant Current Mode (CC mode)" p. 32

---

- I want to use the PLZ-4WH in CR mode. → "Constant Resistance Mode (CR)" p. 34

---

- I want to add CV mode to CC mode. → "Configuring CC+CV mode" p. 33

---

- How do I set the protection functions to prevent damage to the DUT? → "Protection Functions" p. 51

---

- How do I use remote sensing to stabilize the PLZ-4WH? → "Remote Sensing" p. 25

---

- How do I check the menu contents? → "Menu" p. 56

---

- How do I reset the PLZ-4WH to its factory default settings? → "Factory Default Settings (Initialization)" p. 58

## Operation

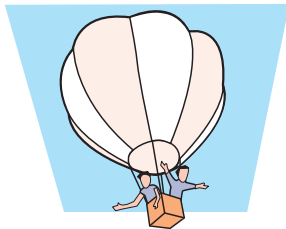

- How do I operate the PLZ-4WH at a specified current? How do I save current values to the preset memory? → "ABC Preset Memory" p. 47

---

- How do I edit sequence programs? → "Sequences" p. 59

---

- How do I control the PLZ-4WH using external voltage? → "External Control" p. 82

---

- How do I stop a sequence that is being executed? → "Executing, Pausing, and Stopping Sequences" p. 79

---

- How do I use an external contact to turn the load on and off? → "Turning the Load On and Off through External Control" p. 96

## Maintenance

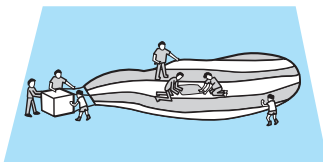

- I want to know about the backup battery's replacement period. → "Backup battery replacement" p. 109

---

- How should I clean the PLZ-4WH? → "Cleaning the dust filter" p. 108

---

- How do I calibrate the PLZ-4WH? → "Calibration" p. 110

## To solve problems

See "Troubleshooting" on page 117.



# Front Panel

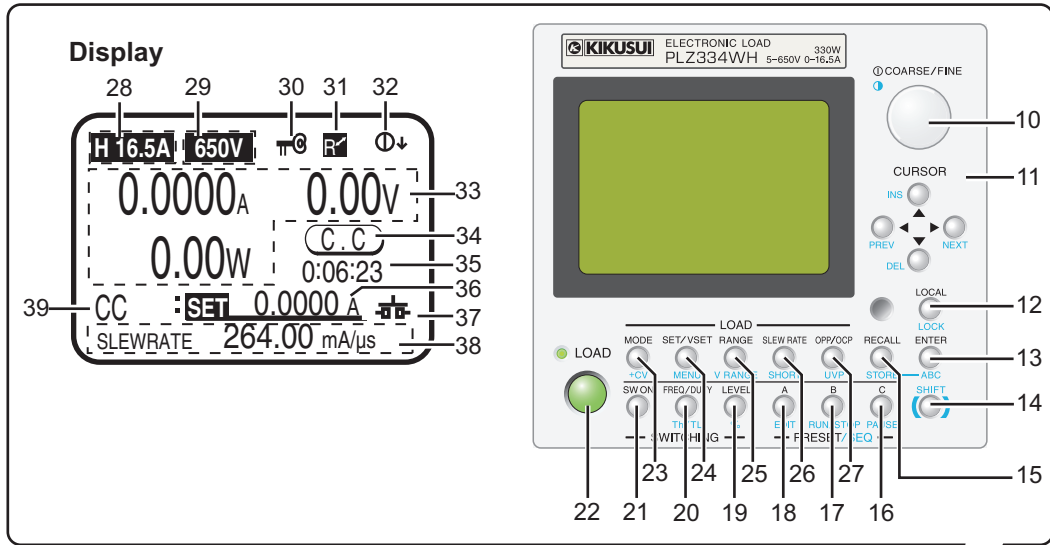

PLZ164WH/ PLZ334WH  
(Example: PLZ334WH)

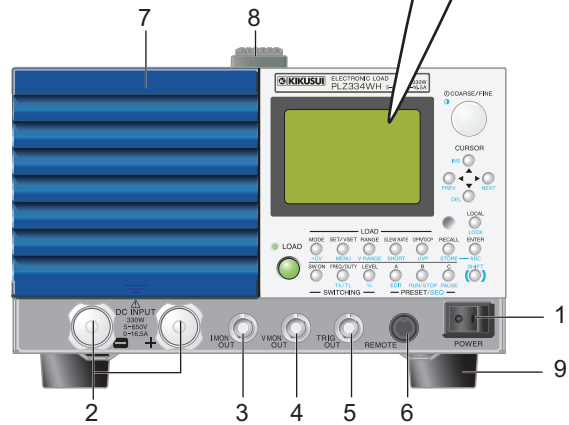

PLZ1004WH

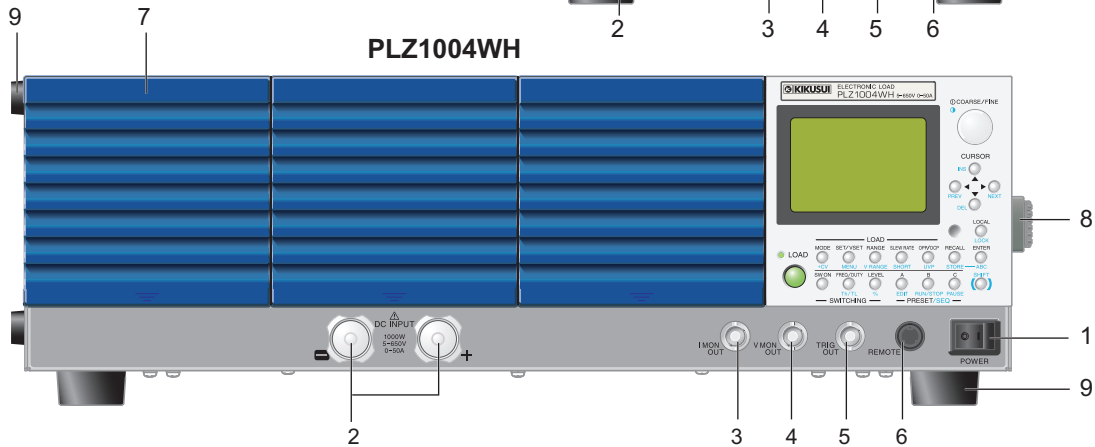

No.	Name	Function	See
1	POWER switch	Flip the switch to the ( I ) side to turn the power on. Flip it to the ( O ) side to turn the power off.	p. 15
2	DC INPUT	The load input terminals on the front panel for connecting the DUT and the PLZ-4WH.	p. 17
3	I MON OUT	An output terminal for monitoring the current.	p. 100
4	V MON OUT	An output terminal for monitoring the voltage.	p. 101
5	TRIG OUT	Produces a pulse signal during sequence or switching operation.	p. 100
6	REMOTE	Connector for expanding functions.	-
7	Air inlet	An air inlet for cooling. It has a dust filter.	-
8	Handle	A handle for carrying the PLZ-4WH.	-
9	Feet	PLZ164WH/ PLZ334WH : Four locations on the bottom PLZ1004WH : Four locations on the bottom, four locations on the side.	p. 13



No.	Name	Function	See
10	Rotary knob	Used to make selections and change settings.	p. 28
11	CURSORS ▲ ▼ ◀ ▶	Up, down, left, and right keys.	–
	INS key	Inserts a step (sequence editing).	–
	DEL key	Deletes a step (sequence editing).	–
	PREV key	Returns to the previous screen (menu settings).	–
	NEXT key	Switches to the next screen (menu settings).	–
12	LOCAL key	Used to switch to local mode from remote mode.	p. 44
	LOCK key	Used to set the key lock.	p. 43
13	ENTER key	Used to confirm the input (menu settings).	–
	ABC key	Used to save settings to the preset memory.	p. 47
14	SHIFT key	Shift key.	p. 28
15	RECALL key	Used to recall the setup memory.	p. 50
	STORE key	Used to save the setup memory.	p. 49
16	C key	Used to access preset memory C.	p. 47
	PAUSE key	Pauses the PLZ-4WH during sequence operation.	p. 79
17	B key	Used to access preset memory B.	p. 47
	RUN/STOP key	Stops the PLZ-4WH during sequence operation.	p. 79
18	A key	Used to access preset memory A.	p. 47
	EDIT key	Used to edit sequences.	p. 59
19	LEVEL key	Used to set the switching level to a current or conductance value.	p. 38
	% key	Used to set the switching level to a percentage.	–
20	FREQ/DUTY key	Used to set the switching frequency and duty ratio.	p. 39
	Th/TL key	Used to set the switching time.	–
21	SW ON key	Turns the switching function on and off.	p. 39
22	LOAD key	Turns the load on and off.	p. 29
23	MODE key	Switches the operation mode.	p. 31
	+CV key	Adds CV mode (constant voltage) to CC or CR mode.	p. 33, p. 35
24	SET/VSET key	Used to set the fundamental settings (current, conductance, voltage, or power).	–
	MENU key	Displays the menu setup screen.	p. 56
25	RANGE key	Switches between the appropriate ranges (current, conductance, voltage, or power) for the current operation mode.	–
	V RANGE key	Switches between voltage ranges.	–
26	SLEW RATE key	Used to set the slew rate.	p. 40
	SHORT key	Turns the short function on and off.	p. 42
27	OPP/OCP key	Used to set the power at which overpower protection (OPP) is activated or the current at which overcurrent protection (OCP) is activated.	p. 52
	UVP key	Used to set the voltage at which undervoltage protection (UVP) is activated.	p. 53
28	Current Range	Displays the current range.	–
29	Voltage range	Displays the voltage range.	–
30	Lock icon	Appears when the key lock is enabled.	p. 43
31	Remote icon	Appears during remote control.	–
32	COARSE/FINE icon	Indicates whether the rotary knob is set to coarse or fine adjustment.	p. 28
33	mA/A	Displays the measured current value.	–
	V	Displays the measured voltage value.	–
	W	Displays the measured power value.	–
34	Operation status	Indicates the operation mode being used or the status. In CC+CV mode, CC or CV is displayed. In CR+CV mode, CR or CV is displayed.	p. 31
35	Elapsed time	Displays the amount of time that has elapsed since the load was turned on.	p. 55
36	Setting	Displays the fundamental setting (current, voltage, power, or conductance).	–
37	Short icon	Appears when the short function is being used.	p. 42
38	Multi display	Displays settings other than the fundamental setting. When a value can be set, it is underlined, and the item name is highlighted.	–
39	Set operation mode	Displays the set operation mode.	–

# Rear Panel

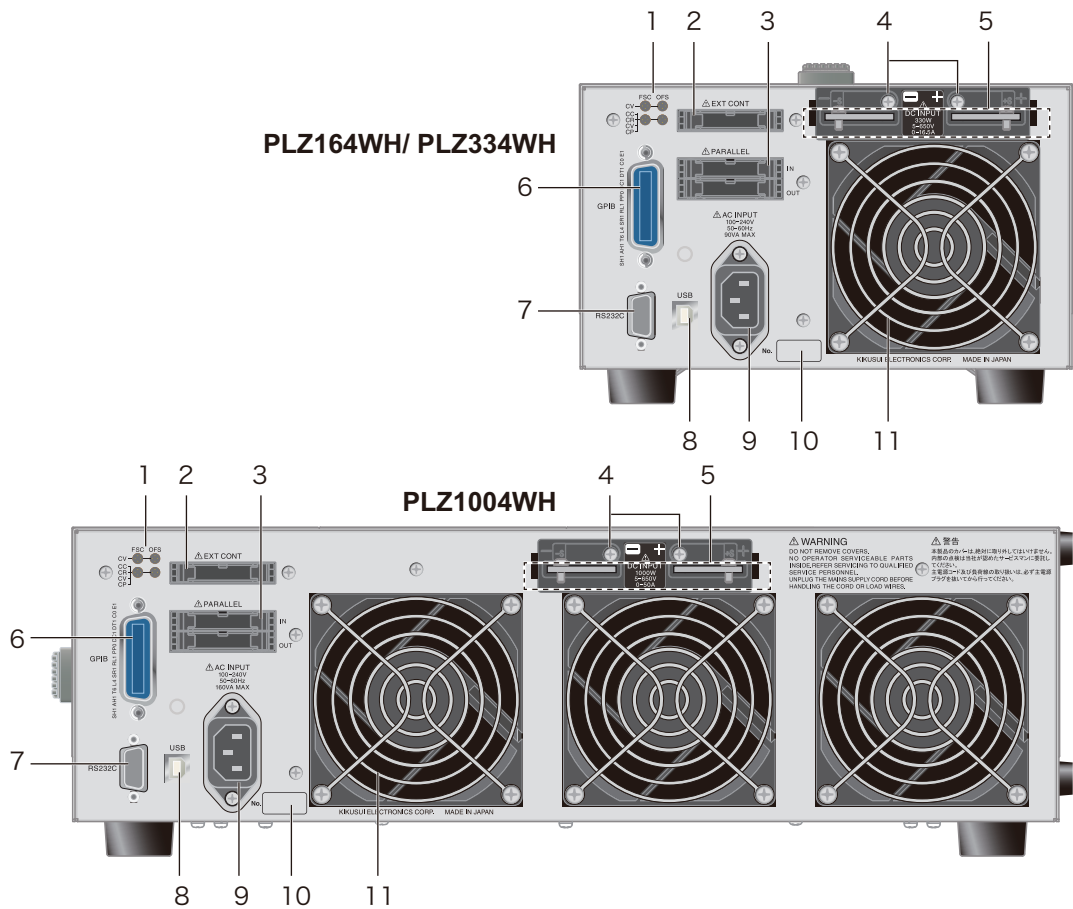

No.	Name	Function	See
1	FCS/ OFS	Variable resistor used to adjust the full scale and offset settings of the PLZ-4WH with respect to the input value of the external control source.	p. 95
2	EXT CONT	External control connector	p. 82
3	PARALLEL	Master-Slave control connector	p. 103
4	+S、 -S	Remote sensinh terminal	p. 25
5	DC INPUT	The load input terminals on the rear panel for connecting the DUT and the PLZ-4WH.	p. 17
6	GPIB	GPIB cable connector for controlling the PLZ-4WH remotely.	-
7	RS232C	RS232C port for controlling the PLZ-4WH remotely.	-
8	USB	USB port for controlling the PLZ-4WH remotely.	-
9	AC INPUT	Power inlet.	p. 14
10	Serial number	The serial number of the PLZ-4WH.	-
11	Air outlet	Vent for cooling the PLZ-4WH.	-



# 1

---

## Installation and Preparation

This chapter describes how to unpack and prepare this product before you use it.

# Checking the Package Contents

When you receive the product, check that all accessories are included and that the accessories have not been damaged during transportation.

If any of the accessories are damaged or missing, contact your Kikusui agent or distributor.

We recommend that you keep all packing materials, in case the product needs to be transported at a later date.

## Accessories

The power cord that is provided varies depending on the destination for the product at the factory-shipment.

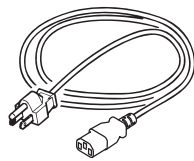

Plug: NEMA5-15  
Rating: 125 Vac/10 A  
[85-AA-0004]

or

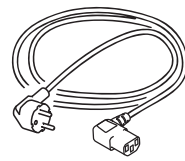

Plug: CEE7/7  
Rating: 250 Vac/10 A  
[85-AA-0005]

or

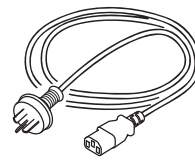

Plug: GB1002  
Rating: 250 Vac/10 A  
[85-10-0790]

Power cord (1 pc.)

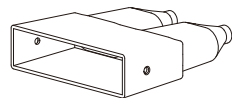

[Q1-500-085]



[P2-000-228]

Load input terminal cover (1 pc.)  
Lock plate (2 pcs.)

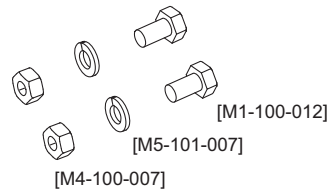

Load input terminal screw set (2 pcs.)

Quick Reference  
(Japanese 1sheet, English 1sheet)

Setup Guide (1 pc.)

CD-ROM (1 pc.)

# Attachment to the rack adapter

1

Before assemble the unit to the rack adapter, remove the handle and the feet. As for the instruction of mount assembly, please refer to the instruction manual of KRA series.

Install the suitable support angles applying to the used rack system to support the instrument.

In case the unit is disassembled from the rack adapter, it is recommended that all the removed parts are kept in the storage.

Once the unit is disassembled from the rack adapter, please attach all the removed parts to original location of each part.

## Removing the handle and feet

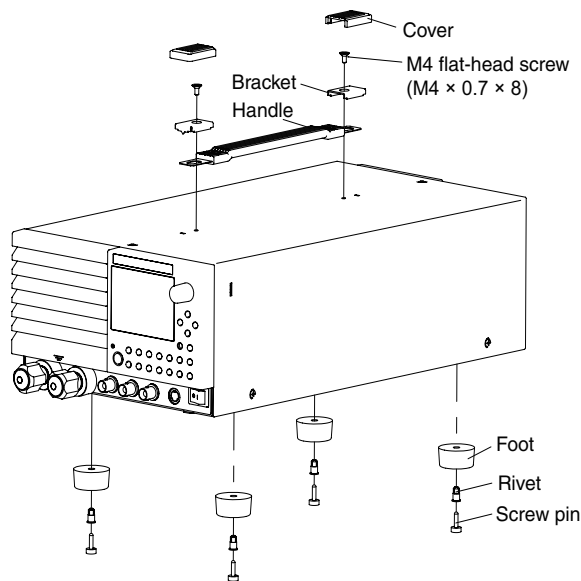

- 1** Pull up on the handle cover (two locations).
- 2** Unfasten the M4 flat-head screws (two locations) and remove the entire handle.
- 3** While pulling down on the feet (there are four of them), use a screwdriver to loosen their screw pins, and then remove them.

# Connecting the Power Cord



## WARNING

To avoid electric shock, observe the following precautions.

- This product is IEC Safety Class I equipment (equipment with a protective conductor terminal). Be sure to earth ground the product to prevent electric shock.
- Connect the protective conductor terminal to earth ground.

## NOTE

- Use the supplied power cord to connect to an AC power line. If the supplied power cord cannot be used because the rated voltage or the plug shape is incompatible, have a qualified engineer replace it with an appropriate power cord that is 3 m or less in length. If obtaining an appropriate power cord is difficult, consult your Kikusui agent or distributor.
- A power cord with a plug can be used to disconnect the product from the AC line in an emergency. Connect the plug to an easily accessible power outlet so that the plug can be removed from the outlet at any time. Be sure to provide adequate clearance around the power outlet.
- Do not use the supplied power cord for other devices.

This product falls under IEC Overvoltage Category II (energy-consuming equipment supplied from the fixed installation).

- 1 Check that the POWER switch is off.**
- 2 Check whether or not the AC power line is compatible with the input rating of the product.**

The voltage that can be applied is any of the nominal power supply voltages in the range of 100 Vac to 240 Vac. The frequency is 50 Hz or 60 Hz.  
Frequency range: 47 Hz to 63 Hz
- 3 Connect the power cord to the rear-panel AC INPUT.**
- 4 Connect the power cord plug to an outlet with a ground terminal.**

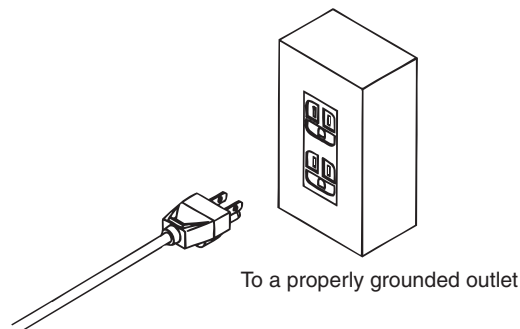

# Turning the Power On

## Turning the POWER switch on

If the POWER switch is turned on for the first time after purchasing the PLZ-4WH, the PLZ-4WH starts up using factory default settings. For all other cases, the PLZ-4WH starts up using the settings that existed when the POWER switch was turned off the last time.

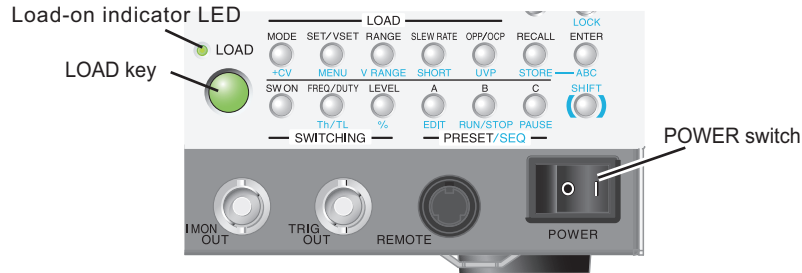

- 1 Check that the POWER switch is turned off (O).
- 2 Check that the power cord is correctly connected.
- 3 Check that nothing is connected to the DC INPUT (load input terminal) on the front panel and rear panel.
- 4 Turn the POWER switch on ( | ).
- 5 Check that the display is in the fundamental setting entry condition.

### ★ Memo

The condition in which characters "SET" is highlighted is called the fundamental setting entry condition.

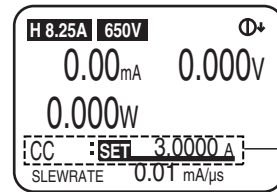

Constant current (CC) mode is selected in this screen, so you can enter the current, which is the fundamental setting.



- 6 Push LOAD. Check that the LED above the key illuminates.
- 7 Push LOAD again. Check that the LED above the key turns off.

If an odd sound, odd odor, fire, or smoke occurs around or in the PLZ-4WH, remove the power plug from the outlet or turn off the power switch.



## When the PLZ-4WH does not start properly

This section introduces what measures you can take when the PLZ-4WH does not start properly. If following the remedy shown here does not solve the problem, contact your Kikusui agent or distributor.

Nothing is displayed.	Make sure that the power cord is connected properly, and then turn the POWER switch on again. Adjusts the contrast of the display.	 p. 28
Abnormal current or voltage values are being displayed.	Turn the PLZ-4WH POWER switch off and then on again.	--
An alarm has occurred.	A protection function has been activated. Eliminate all the cause of the alarm.	 p. 51

## Checking the version

 p. 56

You can check the firmware and ROM versions by selecting “1. Model Info” on the menu screen.



## Turning the POWER switch Off

Flip the POWER switch to the ( O ) side to turn the PLZ-4WH off.

 **CAUTION** After you turn the POWER switch off, wait at least 5 seconds after the fan stops before you turn the POWER switch back on. Turning the PLZ-4WH on too soon after you turn it off can cause damage to the inrush current limiter circuit, as well as reduce the life of components such as the POWER switch and the internal input fuses.

The PLZ-4WH saves the panel settings (except the load on/off setting) that were in use immediately before the POWER switch was turned off. When you turn on the POWER switch, the PLZ-4WH starts up with the saved settings. If the POWER switch is turned off immediately after the settings have been changed, the last settings may not be stored.

# Load wiring

**WARNING**

- **Improper use of load wires may lead to fire. Use load wires whose capacity is adequate for the PLZ-4WH's rated output current.**
- **Possible electric shock. Use load wires whose rated voltage meets or exceeds the PLZ-4WH's isolation voltage. For details on the PLZ-4WH's isolation voltage, see Chap.7 "General specifications".**

**CAUTION**

- Use a load wire with sufficient diameter for the current as well as non-flammable or flame-resistant cover.

If the wiring that you use for the load has a high resistance, the voltage will drop significantly when current flows, and the voltage at the load input terminals may fall below the minimum operating voltage. Using the following table as a reference, select wiring whose nominal cross-sectional area is as thick as possible.

A wire's temperature is determined by the resistive loss based on the current, the ambient temperature, and the wire's external thermal resistance. The following table shows the current capacity of heat-resistant vinyl wires that have a maximum allowable temperature of 60 °C when one of the wires is separated and stretched out horizontally in air in an ambient temperature of 30 °C. The current must be reduced under certain conditions, such as when vinyl wires that have a low heat resistance are used, when the ambient temperature is 30 °C or greater, or when wires are bundled together and little heat is radiated.

Nominal Cross-Sectional Area [mm <sup>2</sup> ]	AWG (Reference Cross-Sectional Area) [mm <sup>2</sup> ]	Allowable Current <sup>1</sup> [A] (Ta = 30°C)	Kikusui-Recommended Current [A]
2	14 (2.08)	27	10
3.5	12 (3.31)	37	–
5.5	10 (5.26)	49	20
8	8 (8.37)	61	30
14	6 (13.3)	88	50
22	4 (21.15)	115	80
30	2 (33.62)	139	–
38	1 (42.41)	162	100
50	1/0 (53.49)	190	–
60	2/0 (67.43)	217	–
80	3/0 (85.01)	257	200
100	4/0 (107.2)	298	–
125	–	344	–
150	–	395	300
200	–	469	–
250	–	556	–
325	–	650	–

<sup>1</sup> Excerpts from Japanese laws related to electrical equipment.

# Methods for Ensuring Stable Operation

When you use the PLZ-4WH at a high response speed, it is important to reduce the inductance of the load wiring and configure the response speed setting appropriately. If the conditions are not configured appropriately, oscillation and other forms of operational instability may occur.

## Reducing the load wiring inductance

### Voltage generated by current changes

The wiring has an inductance of  $L$ . If current  $I$  changes quickly, a large voltage is induced on both sides of the wiring. All of this voltage will be applied to the load input terminals of the electronic load if the impedance of the DUT is low. Voltage  $E$  (hereafter referred to as the generated voltage), which is generated according to the wiring inductance  $L$  and the amount of current change  $I$  is expressed as follows:

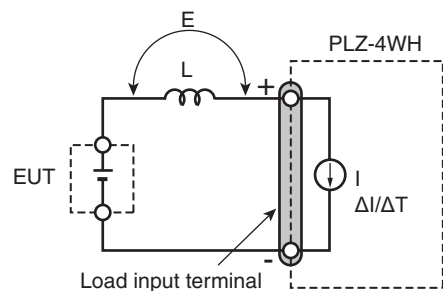

$$E = L \times (\Delta I / \Delta T)$$

- E: Generated voltage
- L: Load wiring inductance
- $\Delta I$ : Change in current
- $\Delta T$ : Duration of time over which the current changes

Generally, a wire's inductance is approximately  $1 \mu\text{H}$  per meter of wire. If the DUT and the electronic load are connected using  $1 \text{ m}$  of wire (total length of the positive and negative wiring), a change in current of  $50 \text{ A}/\mu\text{s}$  will generate a voltage of  $50 \text{ V}$ .

The negative load input terminal provides the reference potential for the external control signal. The generated voltage may cause the device connected to the external control signal to malfunction.

When the electronic load is in constant-voltage, constant-resistance, or constant-power mode, it uses the voltage at the load input terminals to change the load current. So it is easy for the electronic load to be influenced by the generated voltage.

### Large voltage drop caused by current changes during switching operation

Make the wiring to the DUT as short as possible, and twist it. When the wiring is long or contains a large loop, its inductance increases, and current changes caused by switching operations will result in large voltage drops.

If the instantaneous voltage value at the load input terminals drops below the minimum operating voltage, the recovery response will be delayed significantly. You need to be especially careful when the slew rate setting is high and when switching operation is performed at high currents.

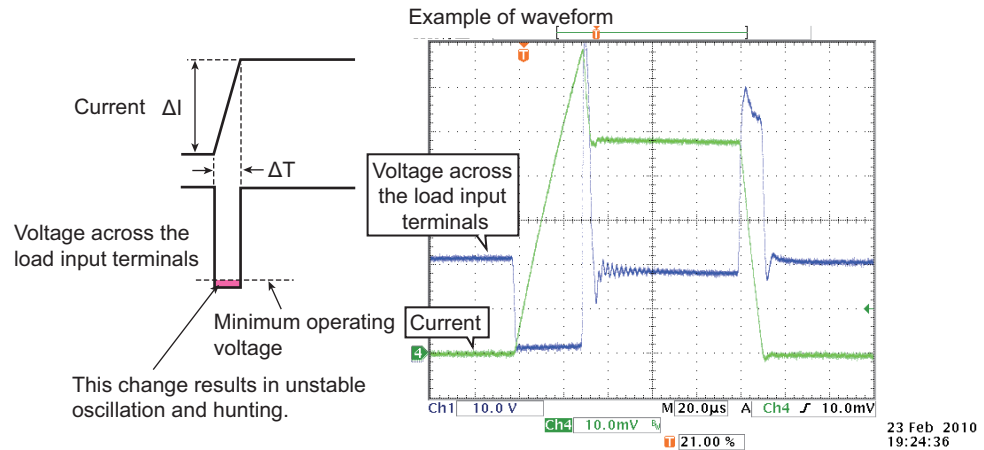

To make sure that the voltage resulting from inductance remains within the range of the electronic load's minimum operating voltage and maximum input voltage, make the wiring as short as possible and twist the wiring, or reduce the slew rate. If it is not necessary to operate at a high response speed, reduce the slew rate or reduce the response speed in CC mode or CR mode.

### Current phase lag

Even during DC operation, it is possible for the phase lag of the current to result in unstable electronic-load control and oscillation. Make the wiring as short as possible, and twist it.

If you only need to use DC operation, connecting a capacitor and a resistor to the load input terminals can reduce oscillation. Do not exceed the capacitor's ripple-current rating.

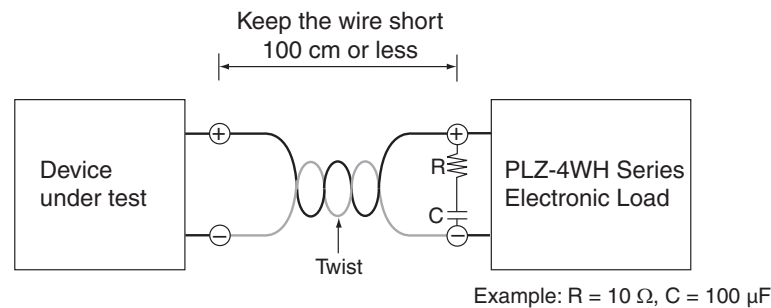

### Optimizing the response speed

You can change the response speed in CC mode, CV mode and CR mode. The wiring inductance can cause the current to lag the voltage. This can result in unstable control of the PLZ-4WH and oscillation.

To ensure stable operation, reduce the response speed.

See p. 54

## Do not apply excessive voltages to the load input terminals

**CAUTION** Do not apply a voltage that is greater than the maximum voltage of 650 Vdc to the load input terminals. Doing so may damage the product.

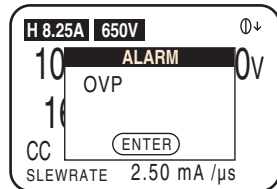

The maximum voltage that can be applied to the load input terminals is 650 Vdc. You cannot use voltages that exceed 650 Vdc. When excessive voltage is applied, the protection functions are activated. Lower the voltage of the DUT immediately.

## Match the polarities of the load input terminals and the DUT terminals

**CAUTION** Connecting the electronic load to the DUT with the polarities reversed can result in the flow of excessive current and damage to the DUT and the electronic load.

Connect each load input terminal to the terminal on the DUT with the same polarity.

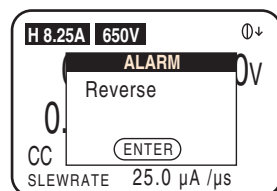

The protection functions are activated when a reverse voltage of approximately 0.4 V or greater is applied. If this happens, turn off the DUT immediately.

# Connecting to the Load Input Terminals

The PLZ-4WH has load input terminals on both its front and rear panels. The specifications of the product are for the load input terminals on the rear panel.



**WARNING**

**Possible electric shock.**

- Do not touch the load input terminals when the output is turned on.
- The load input terminals on the front panel are connected internally to the load input terminals on the rear panel. The voltage applied to the terminal on one side is transmitted directly to the terminal on the other side.



**CAUTION**

To avoid damaging the product, observe the following precautions.

- Do not connect the DUT to the DC INPUT terminals when the load is on.
- Do not connect electronic loads to the load input terminals on the front panel and those on the rear panel at the same time.

To avoid overheating, observe the following precaution.

- Attach crimping terminals to the wires, and use the attached screw set to connect them.

## Connecting to the load input terminals on the rear panel

This section explains how to connect the DUT to the DC INPUT terminals on the rear panel (the rear panel load input terminals).



**WARNING**

**Possible electric shock. Always use the load input terminal cover.**

### Using the load input terminal cover

Pass the wiring that you intend to connect to the load through the load input terminal cover. Cut the cover's sleeves to match the thickness of the wiring

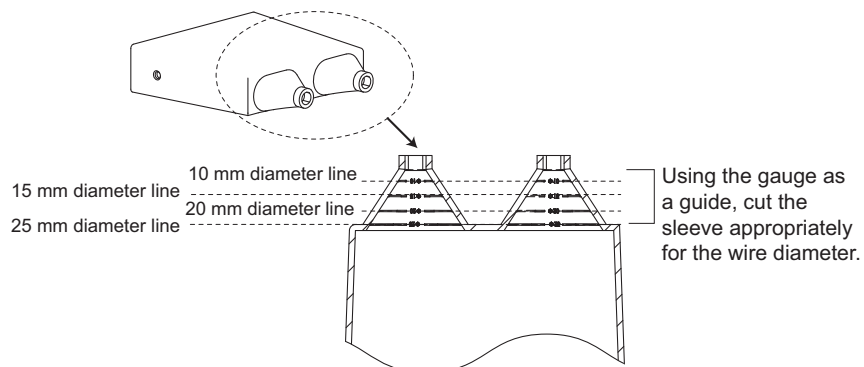

## Connection procedure

- 1** Turn the **POWER** switch off.
- 2** Make sure that the output of the DUT is off.
- 3** **Attach the lock plates to the load input terminals on the rear panel.**  
After you attach the lock plates once, there is no need to remove them.

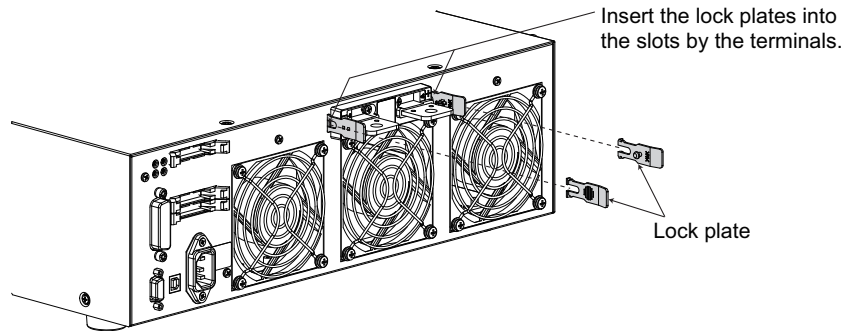

- 4** **Attach crimping terminals to the load wiring.**  
The DC INPUT terminals on the rear panel have open bolt holes (M8) for connecting the load wiring. Attach appropriate crimping terminals.
- 5** **Pass the wiring that you want to connect to the load through the attached load input terminal cover.**
- 6** **Connect the load wires to the load input terminals on the rear panel using the included load input terminal screw set.**

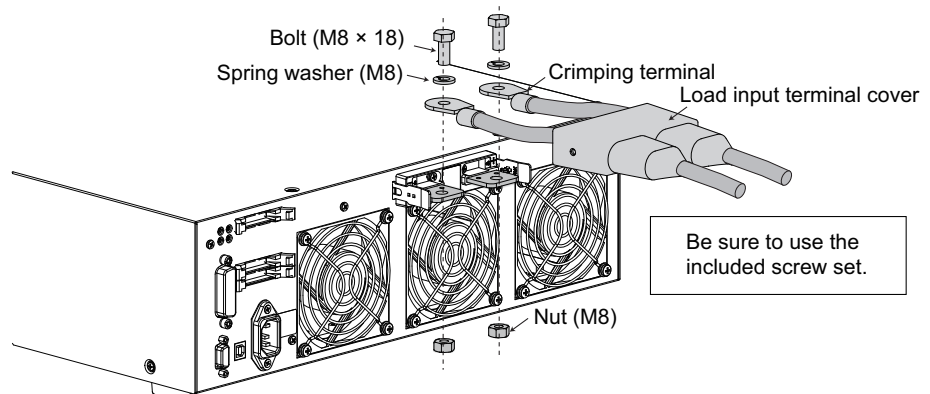



- 7 Use the lock plates to fix the load input terminal cover to the rear panel.**  
To fix the cover in place, insert the lock plate pins into the holes on the sides of the cover.

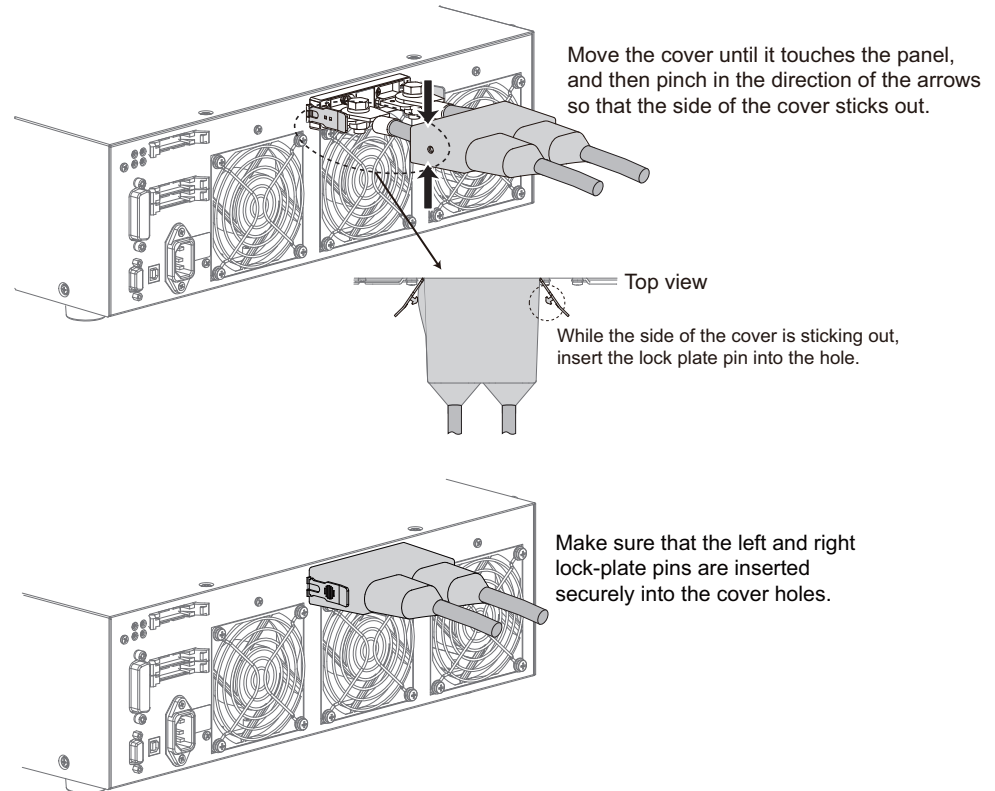

- 8 Connect the load wires to the output terminals of the DUT.**  
Connect the positive load input terminal on the rear panel to the positive terminal of the DUT, and connect the negative load input terminal on the rear panel to the negative terminal of the DUT.

## Removing the load input terminal cover

Open the lock plates on both sides to remove the pins from the holes in the cover.

## Connecting to the load input terminals on the front panel

The load input terminals on the front panel enable you to easily connect the DUT to the PLZ-4WH.

The specifications of the product are for the load input terminals on the rear panel.



To avoid electric shock, attach insulation caps to the crimping terminals.

- 1** Turn the **POWER** switch off.
- 2** Make sure that the output of the DUT is off.
- 3** Connect the load wires to the load input terminals on the front panel.

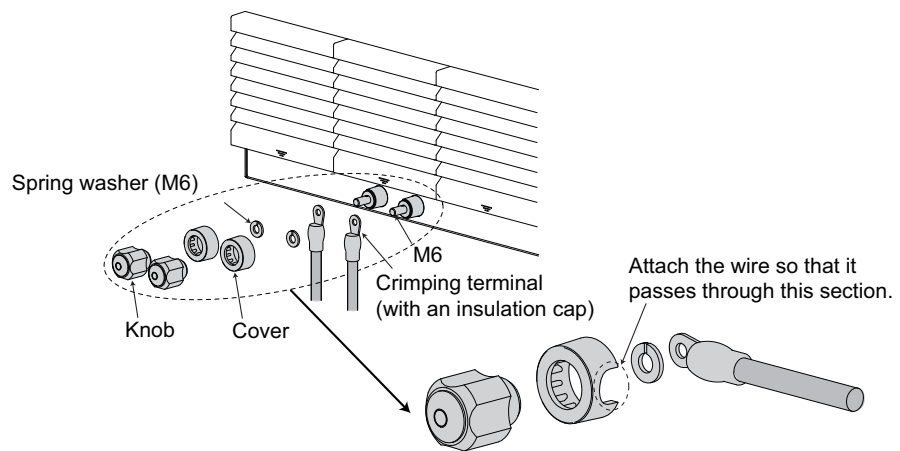

- 4** **Connect the load wires to the output terminals of the DUT.**  
Connect the positive load input terminal on the front panel to the positive terminal of the DUT, and connect the negative load input terminal on the front panel to the negative terminal of the DUT.

# Remote Sensing

When the load wiring is long, the voltage drop caused by the wiring's resistance cannot be ignored. "Remote sensing" is a function that can be used to compensate for this voltage drop. To accurately set the resistance, voltage, and power, use remote sensing.

Remote sensing makes operation more stable by improving the transient characteristics in the constant-resistance (CR), constant-voltage (CV), and constant-power (CP) modes.

**CAUTION**

- Never wire the sensing terminals while the POWER switch is turned on. Doing so may damage the internal circuitry.
- If a wire is disconnected during remote sensing, the PLZ-4WH and the DUT may be damaged. Make sure that wire connections are secure.

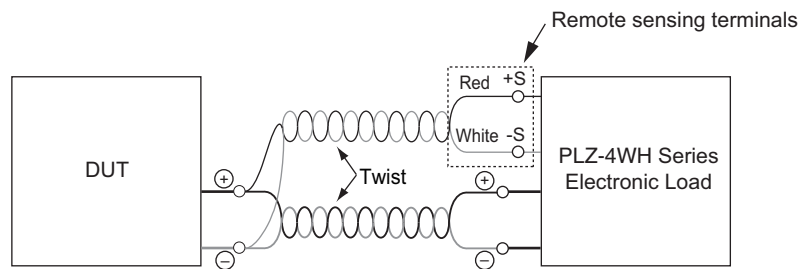

Unlike the load wires, there is no need to consider the current capacity for the wires that you connect to the sensing terminals. However, for adequate mechanical strength, use wires whose nominal cross-sectional area is 0.5 mm<sup>2</sup> or greater.

**1 Turn the POWER switch off.**

**2 Connect the sensing terminals to the DUT using sensing wires.**

Connect the positive remote sensing terminal on the rear panel (+S) to the positive terminal (+) on the DUT. In the same way, connect the negative remote sensing terminal (-S) on the rear panel to the negative terminal (-) on the DUT. Connect the wiring as close to the DUT as possible.





# 2

---

## Basic Functions

This chapter explains the operations for each operation mode and other basic functions.

# Panel Operation Basics

You can perform operations from the operation panel on the front of the PLZ-4WH. The PLZ-4WH produces a beeping sound to notify you when you make an invalid selection or perform an invalid key operation.

## Function of the LOAD key

If you press LOAD when the load is turned off, the LOAD LED lights, and the load turns on. If you press LOAD when the load is turned on, the LOAD LED turns off, and the load turns off.

## How to use the rotary knob

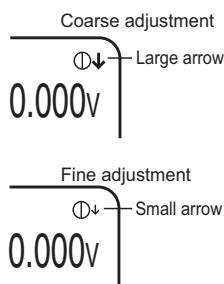

Use the rotary knob to set values such as the current and resistance. Turning the rotary knob clockwise increases a value and turning it counterclockwise decreases the value.

### ■ Coarse and fine adjustment

You can switch between coarse and fine adjustment by pressing the rotary knob. When the down arrow shown at the upper right corner of the screen is large, coarse adjustment is selected; when it is small, fine adjustment is selected.

The fine adjustment setting resolution is ten times that of coarse adjustment. During coarse adjustment, you can make even more coarse adjustments by holding LOCAL while you turn the rotary knob.

### NOTE

When you set a value, it is convenient to first use coarse adjustment to set the value roughly and then to switch to fine adjustment to set it precisely.

## Popup menu operation

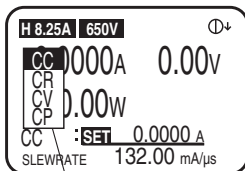

Popup menu

Some keys show a popup menu when you press them. If you press the key again while the menu is shown, the selected item changes. The selected item changes to the next lowest item each time you press the key. When you finish the key operation, the item at that point is selected, and the popup menu is cleared automatically.

## How to use the SHIFT key

The SHIFT key switches the function of each key. If you press a key without holding down SHIFT, the function indicated above the key is enabled; if you press a key while holding down SHIFT, the function indicated below the key is enabled.

For example, if you press SET/VSET without holding down SHIFT, the SET/VSET (indicated in black) function is enabled. If you press SET/VSET while holding down SHIFT, the MENU (indicated in blue) is enabled.

This manual denotes the operation of pressing a key while holding down SHIFT as SHIFT+(notation above the key). For example, the selection of the MENU key is denoted as "MENU (SHIFT+SET/VSET)." In this case, press SET/VSET while holding down SHIFT.

## Adjusting the display contrast

You can adjust the contrast of the display by turning the rotary knob while you hold SHIFT.

# Turning the Load On and Off

The load is on when current is flowing through the PLZ-4WH or when the PLZ-4WH is supplying current. The load is off when current is not flowing through the PLZ-4WH and the PLZ-4WH is not supplying current. You can turn the PLZ-4WH's load on and off by pressing LOAD. The terms "load on" and "load off" appear frequently in this manual, so please remember them.



To avoid damaging the PLZ-4WH, be sure to follow the proper procedures for turning the load on and off.

## Turning the load on

**1 Make sure that the load is off.**

**2 Apply the output of the DUT to the PLZ-4WH.**

If you are using a relay, electromagnetic switch, or other device in the connection between the load input terminals and the output terminals of the DUT, turn the device on.

**3 Press LOAD to turn on the load.**

### Starting with the load turned on

By factory default, the load is not turned on unless you press LOAD after turning on the POWER switch.

See p. 56

To start the PLZ-4WH with the load turned on, from the menu, select "2. Configuration" > "2. Power On" > "Load On" > "ON." Turn the power switch off and then on again to enable the settings.

### Displaying the time that has elapsed since the load was turned on

This function, which displays the time that has elapsed since the load was turned on, is useful when used in conjunction with undervoltage protection (UVP) in discharge tests of batteries and capacitors. By factory default, the time is not displayed.

See p. 56

To display the time from load on to load off, from the menu, select "1. Setup" > "1. Function" > "Count Time" > "ON."

### Using an external control signal to turn the load on and off

You can turn the load on and off using external control signals from a relay or other device.

See p. 96

### Gradually raising the PLZ-4WH's input current

In constant current mode (CC mode), you can set the PLZ-4WH to raise its input current gradually (soft start).

See p. 41



## Turning the load off

---

- 1** Press **LOAD** to turn off the load.
- 2** Turn off the output of the DUT. If you are using a relay, electromagnetic switch, or other device in the connection between the load input terminals and the output terminals of the DUT, turn the device off.

### ■ Turning the load off after a specified amount of time

The function for turning the load off after a specified period of time is convenient for discharge testing of batteries and capacitors. By factory default, the load on timer is off.

To turn the load on timer on, from the menu, select “1. Setup” > “4. Cut Off” > “Time,” and set the time.

When the load turns off, a popup window appears indicating the input voltage at the time the load was turned off.

 p. 56

# Operation Modes

The following four operation modes are available on the PLZ-4WH. Constant voltage mode can be added to constant current mode or constant resistance mode (+CV).

- Constant current mode (CC mode, CC+CV mode)
- Constant resistance mode (CR mode, CR+CV mode)
- Constant voltage mode (CV mode)
- Constant power mode (CP mode)

## Switching between operation modes

To switch between operation modes, press MODE while the load is off.

You can press +CV (SHIFT+MODE) in CC mode or CR mode to add CV mode. You can add CV mode even while the load is on.

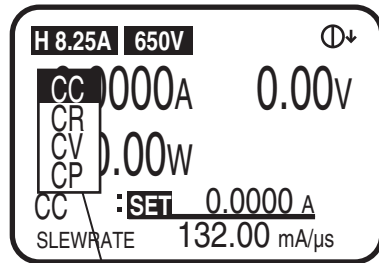

Operation mode

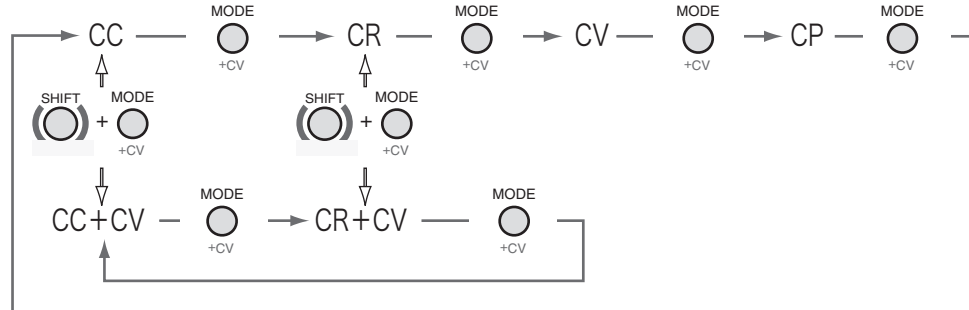

# Constant Current Mode (CC mode)

In constant current mode (CC mode), you set the current [A]. You can also add constant voltage mode (+CV mode) to constant current mode (CC mode).

## Configuring CC mode

Select the operation mode, and set the current.

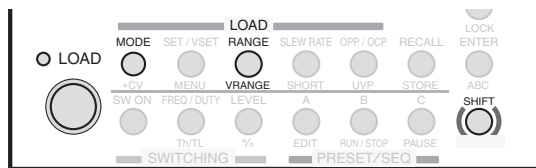

- 1 Make sure that the load is off.**

The load is off when the LED to the upper left of the LOAD key is off. If the LED is lit, press LOAD to turn the load off.
- 2 Press MODE to select the operation mode (CC).**

The operation mode popup menu appears.  
Press MODE repetitively until CC is highlighted on the menu. After you select the operation mode, the popup menu disappears, and “CC” appears on the display.
- 3 Press RANGE to select the current range.**

The current range popup menu appears.  
Each time you press RANGE, the range switches between L, M, and H. Press RANGE until the range that you want to select is highlighted. After you select a range, the popup menu disappears, and the range that you selected appears along with its full scale value. The full scale value varies depending on the model.
- 4 Press VRANGE (SHIFT+RANGE) to select the voltage range.**

The voltage range popup menu appears.  
Each time you press VRANGE (SHIFT+RANGE), the voltage range switches between 65 V and 650 V. Press VRANGE (SHIFT+RANGE) until the range that you want to select is highlighted. After you select a voltage range, it appears on the display.
- 5 Check that the display is in the fundamental setting entry condition.**

If SET is not highlighted, press SET/VSET to switch to the fundamental setting entry condition.
- 6 Turn the rotary knob to set the current.**

**★ Memo**  
When “SET” is highlighted, the PLZ-4WH is in the fundamental setting entry condition.

The CC mode settings are complete. When you press LOAD, the LOAD LED lights, and the PLZ-4WH starts supplying current. You can change the current even when the load is on.

## Configuring CC+CV mode

CC+CV mode is constant current mode (CC mode) with CV mode added to it. You can add CV mode even while the load is on.

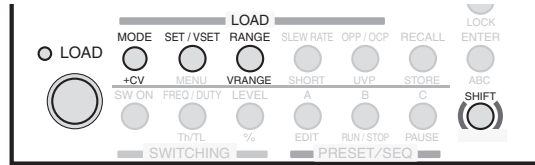

- 1 Configure the constant current settings.**  
 To configure the settings, refer to "Configuring CC mode".
- 2 Press +CV (SHIFT+MODE) to add CV mode.**  
 The PLZ-4WH switches to CC+CV mode, and "CC+CV" appears on the display.
- 3 Make sure that the PLZ-4WH is in the fundamental setting entry condition.**  
 If SET is not highlighted, press SET/VSET to switch to the fundamental setting entry condition.
- 4 Turn the rotary knob to set the current and voltage.**  
 The value that you can set (current or voltage) changes when you press SET/VSET.

### ★ Memo

When "SET" is highlighted, the PLZ-4WH is in the fundamental setting entry condition.

The CC+CV mode settings are complete. Press LOAD to start testing. You can change the current and voltage even when the load is on.

# Constant Resistance Mode (CR)

In constant resistance mode (CR mode), you set the inverse of the resistance, the conductance [S]. You can also display the resistance value converted from the conductance value.

$$\text{Conductance [S]} = 1/\text{resistance } [\Omega]$$

You can also add constant voltage mode (+CV mode) to constant resistance mode (CR mode).

## Configuring CR mode

Select the operation mode, and set the conductance.

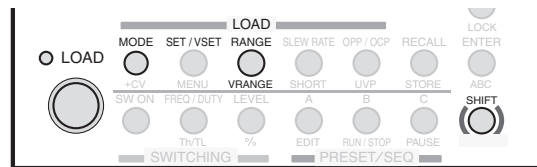

- 1 Make sure that the load is off.**  
The load is off when the LED to the upper left of the LOAD key is off. If the LED is lit, press LOAD to turn the load off.
- 2 Press MODE to select the operation mode (CR).**  
The operation mode popup menu appears.  
Press MODE repetitively until CR is highlighted on the menu. After you select the operation mode, the popup menu disappears, and "CR" appears on the display.
- 3 Press RANGE to select the current range.**  
The current range popup menu appears.  
Each time you press RANGE, the range switches between L, M, and H. Press RANGE until the range that you want to select is highlighted. After you select a range, the popup menu disappears, and the range that you selected appears along with its full scale value. The full scale value varies depending on the model.
- 4 Press VRANGE (SHIFT+RANGE) to select the voltage range.**  
The voltage range popup menu appears.  
Each time you press VRANGE (SHIFT+RANGE), the voltage range switches between 65 V and 650 V. Press VRANGE (SHIFT+RANGE) until the range that you want to select is highlighted. After you select a voltage range, it appears on the display.
- 5 Check that the display is in the fundamental setting entry condition.**  
If SET is not highlighted, press SET/VSET to switch to the fundamental setting entry condition.  
The resistance value converted from the conductance value appears in the multi display. If a different value appears in the multi display, press SET/VSET to display the resistance.

### ★ Memo

When "SET" is highlighted, the PLZ-4WH is in the fundamental setting entry condition.

## 6 Turn the rotary knob to set the conductance.

The CR mode settings are complete. When you press LOAD, the LOAD LED lights, and the PLZ-4WH starts supplying current. You can change the conductance even when the load is on.

## Configuring CR+CV mode

CR+CV mode is constant resistance mode (CR mode) with CV mode added to it. You can add CV mode even while the load is on.

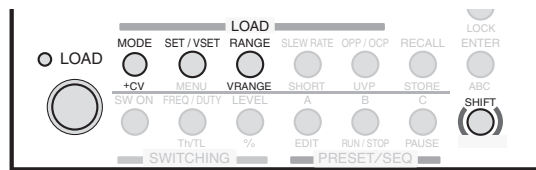

### 1 Configure the constant resistance settings.

To configure the settings, refer to "Configuring CR mode".

### 2 Press +CV (SHIFT+MODE) to add CV mode.

The PLZ-4WH switches to CR+CV mode, and "CR+CV" appears on the display.

### 3 Make sure that the PLZ-4WH is in the fundamental setting entry condition.

If SET is not highlighted, press SET/VSET to switch to the fundamental setting entry condition.

### 4 Turn the rotary knob to set the conductance and the voltage.

The value that you can set (conductance or voltage) changes when you press SET/VSET.

#### ★ Memo

When "SET" is highlighted, the PLZ-4WH is in the fundamental setting entry condition.

The CR+CV mode settings are complete. Press LOAD to start testing. You can change the conductance and voltage even when the load is on.

# Constant Voltage Mode (CV mode)

In constant voltage mode (CV mode), you set the voltage [V].

## Configuring CV mode

Select the operation mode, and set the voltage.

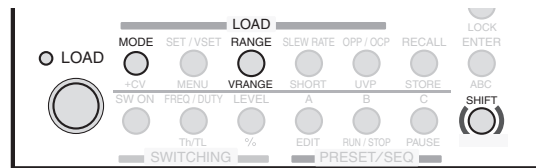

### 1 Make sure that the load is off.

The load is off when the LED to the upper left of the LOAD key is off. If the LED is lit, press LOAD to turn the load off.

### 2 Press MODE to select the operation mode (CV).

The operation mode popup menu appears.

Press MODE repetitively until CV is highlighted on the menu. After you select the operation mode, the popup menu disappears, and "CV" appears on the display.

### 3 Press RANGE to select the current range.

The current range popup menu appears.

Each time you press RANGE, the range switches between L, M, and H. Press RANGE until the range that you want to select is highlighted. After you select a range, the popup menu disappears, and the range that you selected appears along with its full scale value. The full scale value varies depending on the model.

### 4 Press VRANGE (SHIFT+RANGE) to select the voltage range.

The voltage range popup menu appears.

Each time you press VRANGE (SHIFT+RANGE), the voltage range switches between 65 V and 650 V. After you select a voltage range, it appears on the display. Press VRANGE (SHIFT+RANGE) until the range that you want to select is highlighted.

### 5 Check that the display is in the fundamental setting entry condition.

If SET is not highlighted, press SET/VSET to switch to the fundamental setting entry condition.

### 6 Turn the rotary knob to set the voltage.

The CV mode settings are complete. When you press LOAD, the LOAD LED lights, and the PLZ-4WH starts supplying current. You can change the voltage even when the load is on.

#### ★ Memo

When "SET" is highlighted, the PLZ-4WH is in the fundamental setting entry condition.



# Constant Power Mode (CP mode)

In constant power mode (CP mode), you set the power [W].

## Configuring CP mode

Select the operation mode, and set the power.

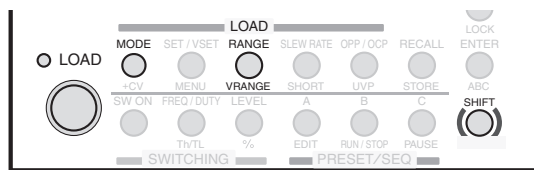

- 1 Make sure that the load is off.**

The load is off when the LED to the upper left of the LOAD key is off. If the LED is lit, press LOAD to turn the load off.
- 2 Press MODE to select the operation mode (CP).**

The operation mode popup menu appears.  
Press MODE repetitively until CP is highlighted on the menu. After you select the operation mode, the popup menu disappears, and “CP” appears on the display.
- 3 Press RANGE to select the current range.**

The current range popup menu appears.  
Each time you press RANGE, the range switches between L, M, and H. Press RANGE until the range that you want to select is highlighted. After you select a range, the popup menu disappears, and the range that you selected appears along with its full scale value. The full scale value varies depending on the model.
- 4 Press VRANGE (SHIFT+RANGE) to select the voltage range.**

The voltage range popup menu appears.  
Each time you press VRANGE (SHIFT+RANGE), the voltage range switches between 65 V and 650 V. Press VRANGE (SHIFT+RANGE) until the range that you want to select is highlighted. After you select a voltage range, it appears on the display.
- 5 Check that the display is in the fundamental setting entry condition.**

If SET is not highlighted, press SET/VSET to switch to the fundamental setting entry condition.
- 6 Turn the rotary knob to set the power.**

**★ Memo**  
When “SET” is highlighted, the PLZ-4WH is in the fundamental setting entry condition.

The CP mode settings are complete. When you press LOAD, the LOAD LED lights, and the PLZ-4WH starts supplying current. You can change the power even when the load is on.

# Switching

The switching function is used to switch between two preset load currents. Switching can be performed in CC mode and CR mode.

Switching is suitable for transient-response testing of regulated DC power supplies and similar devices.

To use the switching function, you need to set a switching level and a switching interval and then turn on the switching function. You can configure switching while the load is on or off.

When you execute switching, a trigger signal is produced from the TRIG OUT terminal on the front panel.

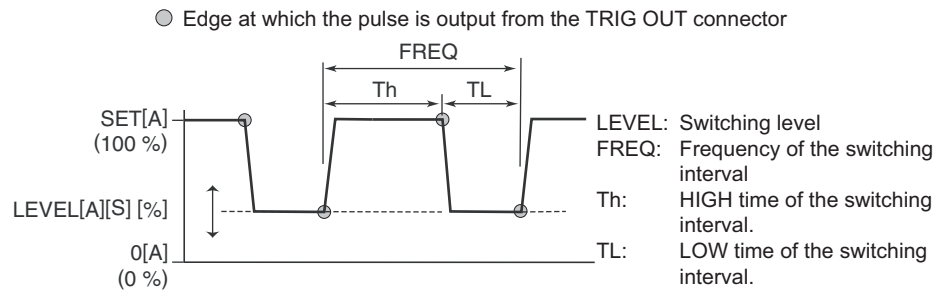

Example in CC Mode

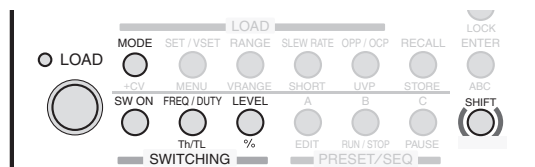

## Setting the switching level

You can set the switching level to a current or conductance value or to a percentage.

### ■ Setting the switching level to a current or conductance value

- 1 Press LEVEL.**  
The LEVEL key lights, and in CC mode, the current can be set; in CR mode, the conductance can be set.
- 2 Turn the rotary knob to set the switching level.**

### ■ Setting the switching level to a percentage

The specified current or conductance level is equivalent to 100 %.

- 1 Press % (SHIFT+LEVEL).**  
The LEVEL key lights, and you can set the switching level to a percentage.
- 2 Turn the rotary knob to set the switching level (0.0 % to 100.0 %).**

## Setting the switching interval

You can set the switching interval by specifying a frequency and duty ratio or by specifying an amount of time.

### ■ Setting the switching interval by specifying a frequency and duty ratio

Set the frequency and the duty ratio (the ratio of HIGH to LOW). It does not matter whether you set the frequency or the duty ratio first. In the following example, the frequency will be set first.

- 1 Press **FREQ/DUTY** until “FREQ” is highlighted.**  
The FREQ/DUTY key lights, and the frequency can be set. Pressing FREQ/DUTY switches between “FREQ” and “DUTY.”
- 2 Turn the rotary knob to set the frequency (1 Hz to 4 kHz).**  
The frequency setting resolution varies depending on the specified frequency. The PLZ-4WH switches between units (Hz and kHz) automatically.
- 3 Press **FREQ/DUTY** to highlight “DUTY.”**  
The FREQ/DUTY key lights, and the duty ratio can be set.
- 4 Turn the rotary knob to set the duty ratio (5 % to 95 %).**  
The minimum time interval is 50  $\mu$ s. The maximum duty ratio is limited as the frequency gets higher.

### ■ Setting the switching interval using two (HIGH and LOW) operation times (Th and TL)

Set the HIGH and LOW times. It does not matter whether you set the HIGH or LOW time first. In the following example, the HIGH time will be set first.

- 1 Press **Th/TL (SHIFT+FREQ/DUTY)** until “Th” is highlighted.**  
The Th/TL key lights, and the HIGH time can be set. Pressing Th/TL (SHIFT+FREQ/DUTY) switches between “Th” and “TL.”
- 2 Turn the rotary knob to set the HIGH time.**
- 3 Press **Th/TL (SHIFT+FREQ/DUTY)** to highlight “TL.”**  
The Th/TL key lights, and the LOW time can be set.
- 4 Turn the rotary knob to set the LOW time.**

#### ★ Memo

When you set Th, the fine adjustment setting resolution is 50 times that of coarse adjustment.

## Turning the switching function on and off

After you finish setting the switching level and the switching interval, turn on the switching function.

If you press SW ON when the switching function is off, the switching function will turn on, and the SW ON key will light.

If you press SW ON when the switching function is on, the switching function will turn off, and the SW ON key light will also turn off.

# Slew Rate

You can use the slew rate to set the speed at which the current is changed. The slew rate is valid in constant current mode (CC mode) and constant resistance mode (CR mode). Use the slew rate when you are using the switching function and at other times when the current is being changed dramatically. You can set the slew rate according to the current range as an amount of current change per unit of time.

## Setting procedure

In CR mode, the slew rate affects the response speed. Decreasing the slew rate may decrease the response speed.

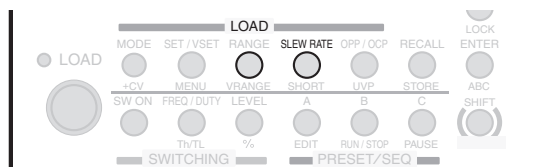

- 1 Press SLEW RATE.**  
The SLEW RATE key lights.
- 2 Turn the rotary knob to set the slew rate.**

# Soft Start

You can use the soft start function to raise the input current gradually. The soft start function is valid in constant current mode (CC mode). Soft start is useful when:

- The load is turned on at the same time that voltage is applied to the load input terminals.
- When the load is on and voltage is applied to it after a period of no input (0 V).

You can reduce the amount of output voltage distortion that occurs when the DUT starts by setting an appropriate soft start time.

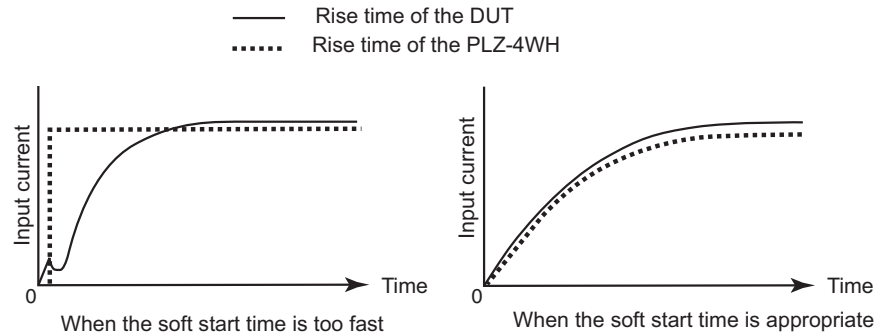

See p. 56

To set the soft start time (1 ms, 2 ms, 5 ms, 10 ms, 20 ms, 50 ms, 100 ms, or 200 ms), from the menu, select "1. Setup" > "1. Function" > "Soft Start."

# Short

See p. 85

When the short function is enabled, the maximum current is set in CC mode or the minimum resistance is set in CR mode, and the short signal output of the EXT CONT connector is turned on. The short signal output terminal is a relay contact (30 Vdc/1 A). You can drive an external relay for high currents or a similar device and short the load input terminals.

## NOTE

Be sure to use a dedicated driver circuit to drive a relay for high current. Please supply the dedicated driver circuit yourself.

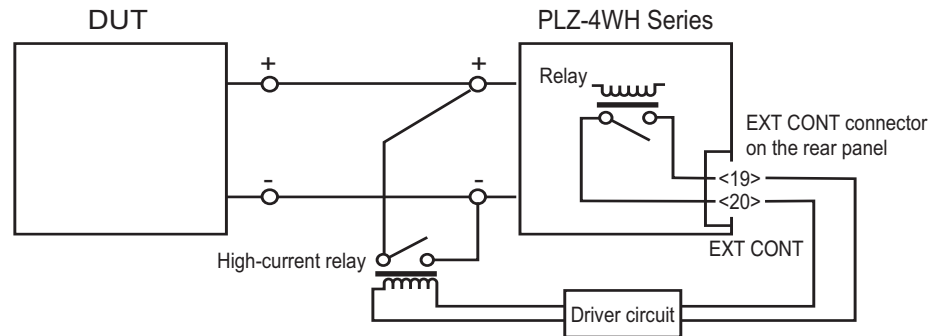

## Turning the short function on and off

You can turn the short function on and off when the load is on.

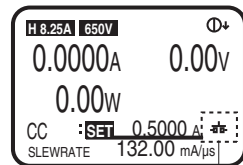

Short icon

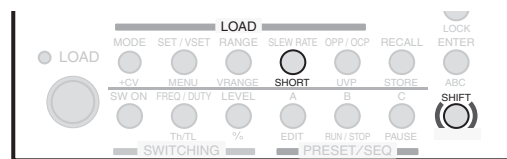

If you press SHORT (SHIFT+SLEW RATE) while the short function is off, the short icon is displayed, and the short function turns on. In constant current mode (CC mode), the fundamental setting is set to the maximum current value; in constant resistance mode (CR mode), the fundamental setting is set to the minimum resistance value.

If you press SHORT (SHIFT+SLEW RATE) while the short function is on, the short icon disappears, and the short function turns off. The fundamental setting returns to the value that it was at before the short function was turned on.

# Locking the Keys

You can lock the PLZ-4WH's keys to prevent mistaken operations such as changes to the settings and overwriting of memory entries and sequence data.

The PLZ-4WH has two types of key locks. The factory default key lock disables most of the keys but leaves some keys enabled. The other key lock disables all the keys.

## ■ Locking most of the keys

The following keys can be used even when the keys are locked.

- LOCK (SHIFT+LOCAL; locks and unlocks the keys)
- LOAD (turns the load on and off)
- A, B, and C (recall preset memory entries directly)
- A, B, and C and ENTER (used to recall preset memory entries using the safety function)
- RECALL, rotary knob, and ENTER (used to load setup memory entries)
- RUN/STOP (SHIFT+B), rotary knob (used to start and stop sequence execution)
- SHORT (SHIFT+SLEW RATE)

See p. 56

From the menu, select "1. Setup" > "1. Function" > "Key Lock" > "SET-KEY."

## ■ Locking all the keys

Locking all the keys disables all keys except for the LOCK (SHIFT+LOCAL) key.

See p. 56

From the menu, select "1. Setup" > "1. Function" > "Key Lock" > "ALL-KEY."

## Locking and unlocking the keys

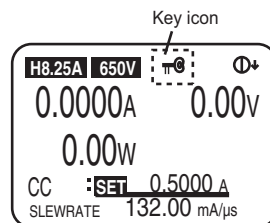

If you press LOCK (SHIFT+LOCAL) when the key icon is not displayed, the keys are locked, and the key icon appears.

When the key icon is displayed, if you press and hold LOCK (SHIFT+LOCAL) until the PLZ-4WH produces a beeping sound, the keys are unlocked, and the key icon disappears.

By factory default, the keys are not locked when you turn the PLZ-4WH on.

To start the PLZ-4WH with the keys locked, from the menu, select "2. Configuration" > "1. Power On" > "Key Lock" > "ON." Turn the power switch off and then on again to enable the settings.

See p. 56

# Switching from Remote Mode to Local Mode

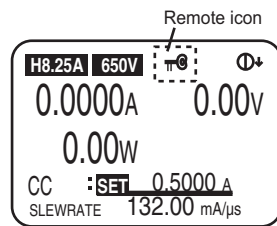

When the PLZ-4WH is in remote mode, the remote icon appears on the display. To use the front panel to switch the PLZ-4WH back to local mode, press LOCAL.





# 3

---

## Advanced Operations

This chapter explains ABC preset memory, setup memory, protection functions, and the menu.

# Memory Types

The PLZ-4WH is equipped with both preset and setup memory.

## ■ Preset memory

You can save fundamental settings (current, conductance, voltage, and power) that are used often in preset memory. Because you can recall saved settings just by pressing a key, this feature is very useful when you want to switch between three different types of output in order.

## ■ Setup memory

You can use setup memory to save all the PLZ-4WH settings. You can recall the contents of a memory entry when the load is off. Check the contents of the memory entry on the screen, and then turn on the load.

## ■ Differences between preset and setup memory

Item	Preset Memory	Setup Memory
Number of memory entries	3	100
Memory number	A, B, or C.	0 to 99
Memo	Not allowed.	Allowed (up to 15 characters)
Saved settings	Fundamental settings (current, conductance, voltage, and power)	Operation mode Fundamental settings (current, conductance, voltage, and power) Current and voltage ranges Slew rate Switching level Switching interval Activation points of protection functions ABC preset memory
When the load is on	Memory entries can be saved and recalled.	Memory entries can be saved but not recalled.
When the load is off	Memory entries can be saved and recalled.	Memory entries can be saved and recalled.

# ABC Preset Memory

You can save preset memory entries to A, B, or C. In A, B, and C, you can save fundamental settings for each range of each operation mode. You can save and load preset memory entries regardless of whether the load is on or off.

The protection-function-activation values are not saved. If the settings that you recall exceed the protection-function-activation values, an alarm will occur.

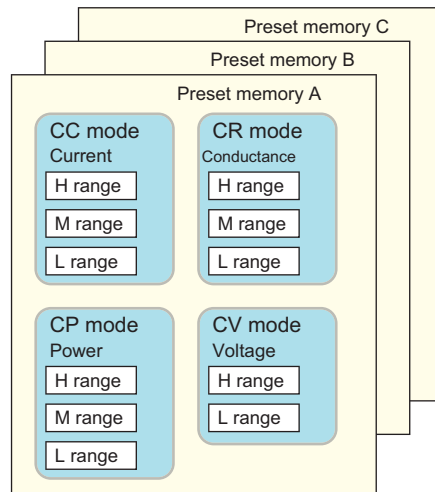

For example, when you save to preset memory A in CC+CV mode (current: M range, voltage: L range):

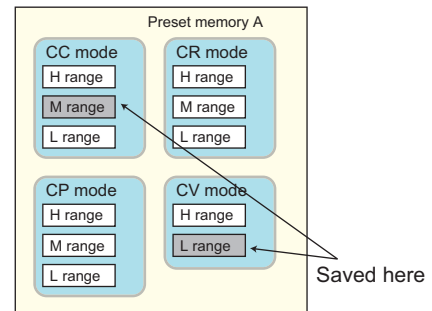

In CC+CV mode, memory entries for CC mode and CV mode are used.  
In CR+CV mode, memory entries for CR mode and CV mode are used.

Operation Mode	Fundamental Settings
CC mode	Current
CR mode	Conductance (resistance)
CP mode	Power
CV mode	Voltage
CC+CV mode	Current and voltage
CR+CV mode	Conductance (resistance) and voltage

## Saving settings to ABC preset memory

For each range of each operation mode, you can save different settings to keys A, B, and C. You can save the settings even when the load is on.

- 1 In the operation mode that you want to create a memory entry for, set the range and values.**
- 2 Press ABC (SHIFT+ENTER).**  
The A, B, and C keys start blinking.
- 3 Of A, B, and C, press the key that you want to save the settings to.**  
The key that you press lights, and the settings are saved to the key that you selected. If you change the settings, the key light turns off.

## Recalling ABC preset memory entries

There are two methods of recalling the preset memory, "SAFETY" and "DIRECT."

### SAFETY

You can recall a memory entry after first checking its contents on the display.

### DIRECT

The settings of the setup memory entry are applied immediately.

The factory default setting is "SAFETY."

You can set the preset memory recall method ("SAFETY" or "DIRECT") from the menu by selecting "1. Setup" > "3. Memory."

See p. 56

### ■ Memory recall method (SAFETY)

**1 Configure the proper operation mode and range settings for the preset memory entry that you want to recall.**

**2 Press the key that corresponds to the preset memory entry (A, B, or C) that you want to recall.**

The selected key lights.

The settings stored in the specified preset memory are displayed. You can recall a different preset memory entry by pressing another preset memory key (A, B, or C).

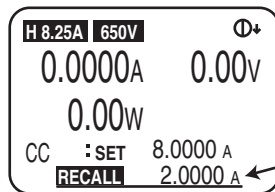

Setting saved to the preset memory.

**3 Check the contents of the preset memory entry, and press ENTER.**

The selected key lights. The settings that correspond to the selected memory entry are recalled and applied. If you change the settings, the key light turns off.

### ■ Memory recall method (DIRECT)

**1 Configure the proper operation mode and range settings for the preset memory entry that you want to recall.**

**2 Press the key that corresponds to the preset memory entry (A, B, or C) that you want to recall.**

The selected key lights. The settings that correspond to the selected memory entry are recalled and applied. If you change the settings, the key light turns off.

#### ★ Memo

You can cancel by pressing PREV (SHIFT+◀).

# Setup Memory

You can save up to 100 setup memory entries (0 to 99). The current settings of the items listed below are saved to the setup memory. You can add a memo of up to 15 characters in length to each memory entry. You can recall a saved memory entry by specifying its number.

- Operation mode
- Fundamental setting values at the time the entry is saved
- Current range
- Voltage range
- Slew rate
- ABC preset memory contents
- Switching level (current/conductance or percentage)
- Switching interval (frequency and duty ratio or an amount of time)
- Protection-function-activation values

## Saving settings to setup memory

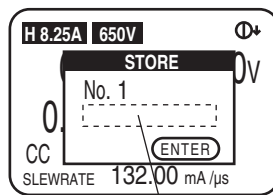

Memo entry area

**★ Memo**  
You can cancel by pressing PREV (SHIFT+◀).

- 1 Set the operation mode, range, and other settings to the values that you want to save.**
- 2 Press STORE (SHIFT+RECALL).**  
The STORE key blinks, and the setup memory storage screen appears. The last memory number that an entry has been saved to appears (when the PLZ-4WH has just been shipped, the number that appears is "0").
- 3 Turn the rotary knob to select the memory number that you want to save to.**  
If you select a memory number that has already been saved to, the previous settings are overwritten.
- 4 To enter a memo, press the ▼ key to move the cursor.**  
The cursor blinks beneath "No." You can select characters by turning the rotary knob. Use the ▶ and ◀ keys to move the cursor. You can register up to 15 characters. Press ▲ to move the cursor back to the memory number.
- 5 Press ENTER.**  
The STORE (SHIFT+RECALL) key lights, and the settings are saved to the setup memory entry. If you change the settings, the key light turns off.

## Recalling setup memory entries

You can save almost all the settings, including the operation mode and range, to the setup memory. Please be aware that if the saved operation mode and range are different from the current settings, they will change.

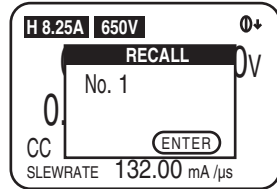

### 1 Make sure that the load is off.

If the LOAD LED is lit, press LOAD to turn the load off.

### 2 Press RECALL.

The RECALL key blinks, and the setup memory recall screen appears. The last memory number that an entry has been saved to appears (when the PLZ-4WH has just been shipped, the number that appears is "0").

### 3 Turn the rotary knob to select the appropriate memory number.

If an entry has a memo, the memo will appear beneath the entry's memory number.

### 4 Press ENTER.

The RECALL key lights, and the setup memory settings are recalled. If you change the settings, the key light turns off.

#### ★ Memo

You can cancel by pressing PREV (SHIFT+◀).

# Protection Functions

The protection functions can be used to automatically turn off the load or limit the current to prevent the PLZ-4WH's internal circuitry from being damaged and to protect the DUT.

An alarm occurs when the protection functions are activated. When an alarm occurs, the load turns off (or the current is limited), and the ALARM STATUS pin (pin 16) of the EXT CONT connector on the rear panel turns on (open-collector output from a photocoupler).

When the load turns off, a popup window appears on the screen.

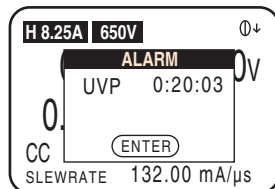

Example of the display when UVP is activated

## Protection function types

See p. 130

The types of protection functions and what they do are listed below. How the protection functions operate in different operation modes is explained in the appendix.

Protection Function	Protection-Function-Activation Value	Protection-Function Action
Overcurrent protection (OCP)	A specified current value (overcurrent-protection-activation value) or 110 % of the maximum current range value	Load off or limit <sup>1</sup>
Overvoltage protection (OVP)	110% of the range's maximum voltage	Load off
Overpower protection (OPP)	A specified power value (overpower-protection-activation value) or 110 % of the maximum power	Load off or limit <sup>1</sup>
Undervoltage protection (UVP) <sup>2</sup>	A specified minimum voltage value (undervoltage-protection-activation value)	Load off
Reverse-connection protection (REV) <sup>3</sup>	A reverse voltage at the load input terminals	Load off
Overheat protection (OHP) <sup>4</sup>	An internal power unit temperature that exceeds the defined limit	Load off
Alarm input protection <sup>5</sup>	An L level (CMOS) signal received by the ALARM INPUT pin (pin 10) of the EXT CONT connector	Load off

<sup>1</sup> If you choose to limit the current, the current is limited so that the protection-function-activation value is not exceeded. Current limiting stops after the alarm is released.

<sup>2</sup> UVP can be disabled.

<sup>3</sup> When a reverse voltage is detected, turn off the DUT immediately.

<sup>4</sup> If OHP is activated, check to make sure that the front panel inlet and the rear panel outlet are not blocked.

<sup>5</sup> Release the alarm of the PLZ-4WH after you release the alarm of the device connected to external control.

## When the remote sensing function is being used

See p. 25

The sensing point of the remote sensing function is the other end of the wire connected to the remote sensing terminal on the PLZ-4WH rear panel. Connect the end of this wire to the output of the DUT that you want to sense. Measurements are made at the sensing point for determining the protection-activation-values of overvoltage protection (OVP), overpower protection (OPP), and undervoltage protection (UVP).



If a wire is disconnected during remote sensing, the PLZ-4WH and the DUT may be damaged. Make sure that wire connections are secure.

## Details about overcurrent protection (OCP)

You can set the value at which OCP is activated.

You can also set the action that is performed when OCP is activated. By factory default, the action is set to LIMIT (the current is limited).

See p. 56

To change the action that is performed ("LIMIT" or "LOAD OFF"), from the menu, select "1. Setup" > "2. Protect Action" > "OCP."

### ■ Setting the overcurrent-protection-activation value

You cannot set the overcurrent-protection-activation value in CC mode.

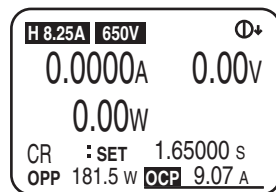

- 1 Make sure that the load is off.**  
If the LOAD LED is lit, press LOAD to turn the load off.
- 2 Press OPP/OCP until OCP is highlighted on the display.**  
The OPP/OCP key lights. Pressing OPP/OCP switches between OCP and OPP.
- 3 Turn the rotary knob to set the overcurrent-protection-activation value.**

## Details about overpower protection (OPP)

You can set the value at which OPP is activated.

You can also set the action that is performed when OPP is activated. By factory default, the action is set to LIMIT (the power is limited).

See p. 56

To change the action that is performed ("LIMIT" or "LOAD OFF"), from the menu, select "1. Setup" > "2. Protect Action" > "OPP."

### ■ Setting the overpower-protection-activation value

You cannot set the overpower-protection-activation value in CP mode.

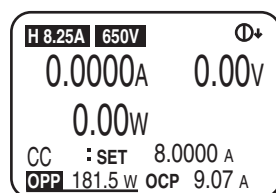



- 1 Make sure that the load is off.**  
If the LOAD LED is lit, press LOAD to turn the load off.
- 2 Press OPP/OCP until OPP is highlighted on the display.**  
The OPP/OCP key lights. Pressing OPP/OCP switches between OCP and OPP.
- 3 Turn the rotary knob to set the overpower-protection-activation value.**

### Details about undervoltage protection (UVP)

 p. 55

You can set the value at which UVP is activated. You can disable UVP by setting the value to OFF.

If the auto load-off timer is on, when UVP is activated, the time from load on to load off is indicated in a popup window that appears.

#### ■ Setting the undervoltage-protection-activation value

- 1 Press UVP (SHIFT+OPP/OCP).**  
The UVP key lights.
- 2 Turn the rotary knob to set the undervoltage-protection-activation value.**  
If you set the value to OFF, undervoltage protection is disabled.

### Details about reverse-connection protection (REV)

 p. 25

When a reverse voltage is detected and the load is turned off, turn off the DUT immediately.

If you are using the remote sensing function and the sensing wires are connected in reverse, a reverse voltage will not be detected because no current will flow even when the load is turned on. Because there is no threat of damage or injury, no alarm occurs.

## Clearing alarms

You can press ENTER when an alarm is activated to clear the alarm. However, the alarm will be activated again if its cause has not been eliminated.

When alarm input is being detected, release the alarm of the PLZ-4WH after you release the alarm of the device connected to external control.

# Response Speed

The PLZ-4WH operates by detecting the input current or voltage and controlling it through negative feedback. You can ensure stable operation by reducing the response speed.

The response speed can be specified in CV mode and CR mode.

Make the wiring as short as possible, and twist it. Then, reduce the slew rate or decrease the response speed to ensure that the voltage resulting from inductance remains within the PLZ-4WH's minimum operating voltage and maximum input voltage ranges.

If the load wiring is long or if there are large loops in the load wiring, voltage drops leading to distortions in the current waveform may occur. In addition, the voltage may exceed the PLZ-4WH's maximum input voltage, causing damage to the PLZ-4WH. Be careful when you are performing switching operations with large currents (when the slew rate is high and when you are operating the PLZ-4WH in parallel).

During DC operation, it is possible for the phase lag of the current to result in unstable PLZ-4WH control and oscillation.

## ■ CC and CR mode response speeds

There are four response speeds in CC mode and CR mode:

1/1: This is the normal response speed (the factory default setting).

1/2: This is 1/2 the normal response speed (twice as slow).

1/5: This is 1/5 the normal response speed (five times as slow).

1/10: This is 1/10 the normal response speed (10 times as slow; equivalent to the PLZ-3WH series).

The settings other than 1/1 result in a slow response speed, so this has an effect on features such as the soft start, the slew rate, and the load on and load off rise and fall times. The slew rate also has an effect on switching operation.

 p. 56

To set the response speed of negative feedback, from the menu, select "1. Setup" > "5. Response" > "CC/CR."

## ■ CV mode response speed

There are five response speeds in CV mode:

100: This is 100 times the normal response speed (100 times as fast; equivalent to the PLZ-3WH series).

10: This is 10 times the normal response speed (10 times as fast).

1: This is the normal response speed.

1/10: This is 1/10 the normal response speed (10 times as slow; factory default setting).

1/100: This is 1/100 the normal response speed (100 times as slow).

 p. 56

To set the response speed of negative feedback, from the menu, select "1. Setup" > "5. Response" > "CV."

# Elapsed Time Display and Auto Load-Off Timer

Two convenient functions are available for the discharge tests of batteries.

- You can measure the time from the start of discharge to the cutoff voltage.
- You can measure the closed-circuit voltage after a specified time has elapsed since the start of discharge (voltage measurement).

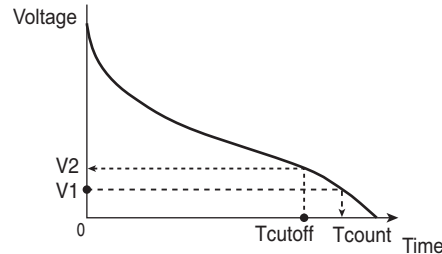

V2: Voltage after the specified time elapses  
V1: UVP activation voltage

Tcount: Elapsed time display (Count Time)  
Tcutoff: Auto load-off timer (Cut Off Time)

## Elapsed time display (Count Time)

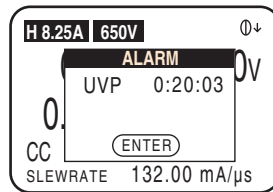

You can measure the time from when the load is turned on until when it is turned off.

As a condition for turning the load off, set the undervoltage-protection-activation voltage to the cutoff voltage. When the load turns off, a popup window appears indicating the time from load on to load off.

By default, the elapsed time after the load is turned on is not displayed.

To set whether or not to display the elapsed time (“ON” or “OFF”), from the menu, select “1. Setup” > “1. Function” > “Count time.”

See p. 56

## Auto load-off timer (Cut Off Time)

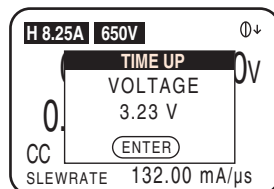

In voltage measurement, the voltage immediately before the load turns off is measured. You can configure the PLZ-4WH to turn the load off after a specified amount of time has elapsed. After the load turns off, a popup window appears indicating the input voltage immediately before the load was turned off.

The auto load-off timer is disabled by default.

To set the auto load-off timer (OFF, 000:00:01 to 999:59:59), from the menu, select “1. Setup” > “4. Cut Off.”

See p. 56

# Menu

In the menu screen, you can set the PLZ-4WH's operating conditions and configure functions.

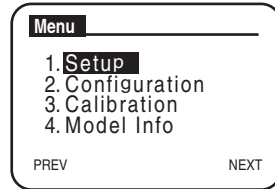

Menu screen (item 1) display

## ★ Memo

Press MENU (SHIFT+SET/VSET) to exit the menu.

Press PREV (SHIFT+◀) to return to the previous screen.

- 1 Make sure that the load is off.**  
If the LOAD LED is lit, press LOAD to turn the load off.
- 2 Press MENU (SHIFT+SET/VSET).**  
The menu screen (item 1) appears.
- 3 Use the rotary knob or press ▼ and ▲ to move to the item that you want to configure.**  
The currently selected item is highlighted.
- 4 Press ENTER or NEXT (SHIFT+▶).**  
The menu screen (item 2) appears.
- 5 Repeat step 3 and step 4 to move to the setting that you want to set.**
- 6 Turn the rotary knob to set the setting.**  
Next, set other conditions.
- 7 After you have finished configuring the settings, press MENU (SHIFT+SET/VSET).**  
The menu screen will close, and the settings that you configured will be applied.

## NOTE

All the configuration settings, are enabled after you turn the power switch off and then on again.

## List of menu items (the factory default settings are underlined>)

Item 1	Item 2	Item 3	Settings	Description	
1.Setup	1.Function	Soft Start	<u>1 ms</u> , 2 ms, 5 ms, 10 ms, 20 ms, 50 ms, 100 ms, 200 ms	Soft start time	
		Count Time	<u>OFF</u> : Not displayed, ON: Displayed	Elapsed time display	
		Key Lock	<u>SET-KEY</u> : Most of the keys are locked. <u>ALL-KEY</u> : All the keys are locked.	Key lock setting	
	2.Protect Action	OCP	LOAD OFF: The load is turned off. <u>LIMIT</u> : The current is limited.	Action to be performed when OCP is activated	
		OPP	LOAD OFF: The load is turned off. <u>LIMIT</u> : The current is limited.	Action to be performed when OPP is activated	
	3.Memory	Recall	<u>DIRECT</u> <u>SAFETY</u>	Method for recalling the preset memory	
	4.Cut Off	Time	<u>OFF</u>	Auto load-off timer	
			0:00:01 to 999:59:59 (Hour:minute:second)	Press ◀ and ▶ to move the cursor between the hour, minute, and second positions.	
		5.Response	CC/CR	<u>1/1</u> , 1/2, 1/5, 1/10	CC/CR mode response speed
		CV	100, 10, 1, <u>1/10</u> , 1/100	CV mode response speed	
2.Configuration <sup>1</sup>	1.Master/Slave	Operation	<u>MASTER</u> , SLAVE	Master-Slave control setting	
		Parallel <sup>2</sup>	<u>—</u> , 2, 3, 4, 5	Number of electronic loads operating in parallel	
		Booster <sup>3</sup>	<u>—</u> , 1, 2, 3, 4	Number of boosters that are connected	
	2.Power On	Load On	<u>OFF</u> : The load is off when the power is turned on. ON: The load is on when the power is turned on.	State of the load when the power switch is turned on	
		Key Lock	<u>OFF</u> : Keys are not locked. ON: Keys are locked.	Key lock	
	3.Interface	Control	<u>GPIB</u> , RS232C, USB	Interface setting	
		GPIB	Address	1 to 30 ( <u>1</u> )	GPIB address
		RS232C	Baudrate	2400bps, 4800bps, 9600bps, <u>19200bps</u>	Baud rate
			Data <sup>4</sup> , Stop	8, <u>1/2</u>	Data length (fixed at 8 bits) and the stop bit
			Parity <sup>4</sup>	<u>NONE</u>	Parity (fixed at NONE)
			Ack	<u>OFF</u> , ON	Acknowledgment
		USB <sup>4</sup>	VID	0x0B3E	Vendor ID
	PID		0x1021 (PLZ164WH) 0x1022 (PLZ334WH) 0x1023 (PLZ1004WH)	Product ID	
	S/N		AB123456 (example)	Serial number	
	4.External	Control	<u>OFF</u> : Disabled, V: Control through external voltage R: Control through external resistance (proportional) Rinv: Control through external resistance (inverted)	External control for the CC, CR, and CP modes	
Control CV			<u>OFF</u> : Disabled, ON: Enabled	External control for CV mode	
LoadOn IN		<u>LOW</u> : Turned on by a low level <u>HIGH</u> : Turned on by a high level	External control logic setting for turning the load on and off		
3.Calibration	1.CC(Low)	Calibration of the PLZ-4WH.			
	2.CC(Mid)	For details, see "Calibration" on page 110.			
	3.CC(High)				
	4.CV 65V				
	5.CV 650V				
4.Model Info <sup>4</sup>	(MODEL)	PLZxxxWH	Model name		
	VERSION SUB	x.xx	Firmware version		
	VERSION MAIN	x.xx	ROM version		

<sup>1</sup> The Configuration conditions, are enabled after the power switch is turned off and then on again.

<sup>2</sup> This is enabled when Operation is set to Master on the 1.Master/Slave screen.

<sup>3</sup> This is enabled when a PLZ1004WH is being used as the master unit and Operation is set to Master on the 1.Master/Slave screen.

<sup>4</sup> Information about the PLZ-4WH. It cannot be changed.

# Factory Default Settings (Initialization)

The PLZ-4WH's backup function saves the current settings, menu settings, and memory entries (ABC and preset) even after the power switch is turned off.

You can initialize the PLZ-4WH to set all of its settings to their factory defaults.

- 1 Turn the POWER switch off (O).**
- 2 Make sure that nothing is connected to the DC INPUT terminals (the load input terminals) on the front panel.**
- 3 While holding down ENTER, turn the POWER switch on (I).**  
Keep holding ENTER until the display lights up and "SET CLR" appears. The PLZ-4WH will start up with the factory default settings.

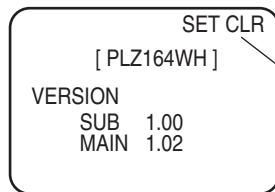

SET CLR  
is displayed.

Example for the PLZ164WH.



# 4

---

## Sequences

This chapter explains the sequence function.

# Sequence Function

The sequence function automatically executes instructions specified in advance one operation at a time. A variety of waveform simulations can be executed through the specification of a sequence of operations (steps). The sequence that you create is saved by the backup function even when the power is turned off.

## Normal sequences and fast sequences

The sequence function enables you to use two types of sequences: normal sequences and fast sequences.

### ■ Normal sequences

For normal sequences, an execution time is assigned to each step. Up to 10 programs can be saved, and the maximum number of steps that can be contained in all programs combined is 256 steps. You can include commands to unpause the PLZ-4WH after it has been paused through the pressing of PAUSE or through an external trigger signal.

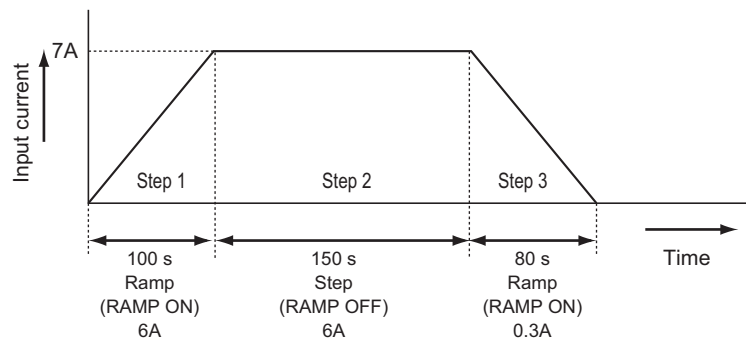

### ■ Fast sequences

For fast sequences, the execution time of each step is determined by the TIME BASE (execution interval) setting. Each step has the same interval. The maximum number of steps is 1024. The high time resolution enables you to create high-speed simulations. You can save one fast sequence program.

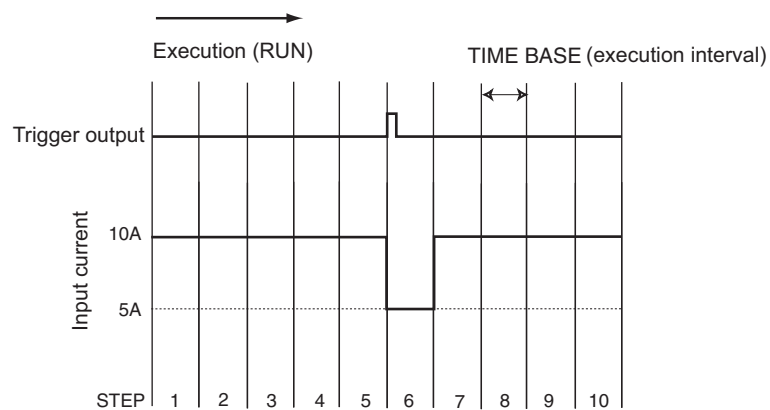



# Common Sequence Editing Operations

This section describes the sequence editing operations that are common to all edit screens, such as moving the cursor within an edit screen, selecting items, entering values and characters, and turning pages. Please familiarize yourself with the functions of each key.

## ■ Moving the cursor

On the edit screen, you can change the value of the item at the position of the blinking cursor. You can move the cursor using the ▲ ▼ ◀ ▶ keys.

Pressing ▼ moves the cursor down, and pressing ▲ moves the cursor up. To move to a specific digit in a value or character in a string or to select a step-execution-pattern item, press ◀ and ▶ to move the cursor to the left and right.

## ■ Selecting items

When an item has multiple choices to select from, turn the rotary knob to select the desired setting. For example, for items that can be turned on and off, you can turn the rotary knob clockwise to select ON and counterclockwise to select OFF.

## ■ Entering values

You can increase or decrease the value of a numerical setting by turning the rotary knob. If the value consists of many digits, you can press ◀ or ▶ to move the cursor directly to the desired digit and increase or decrease only that digit. For example, if you want to set a value to 100, you can simply move the cursor to the hundreds digit, and enter 1 using the rotary knob.

## ■ Entering characters (Memo)

You can register a memo of up to 11 characters in length for each program.

You can use memos to indicate the contents of a program. Not entering a memo will not affect the execution of the sequence. You can enter information such as the date and time of measurement, a test description, a program name, or differences in the setup conditions.

You can select alphanumeric characters by turning the rotary knob. When the desired character is displayed, press ▶ to move the cursor to the right, and enter the next character. To move the cursor to the left, press ◀.

## ■ Turning pages

You can switch between edit screens by pressing SHIFT at the same time as ▲, ▼, ◀, or ▶. To move to the next screen, press NEXT (SHIFT+ ▶). To return to the previous screen, press PREV (SHIFT+ ◀).

# How Normal Sequences Work

Normal sequences are composed of two elements: programs and steps. Programs are groups of executable units called steps. The steps in a program are executed in ascending order, starting from step 001. A single execution of a program is completed after the program's last step has been executed.

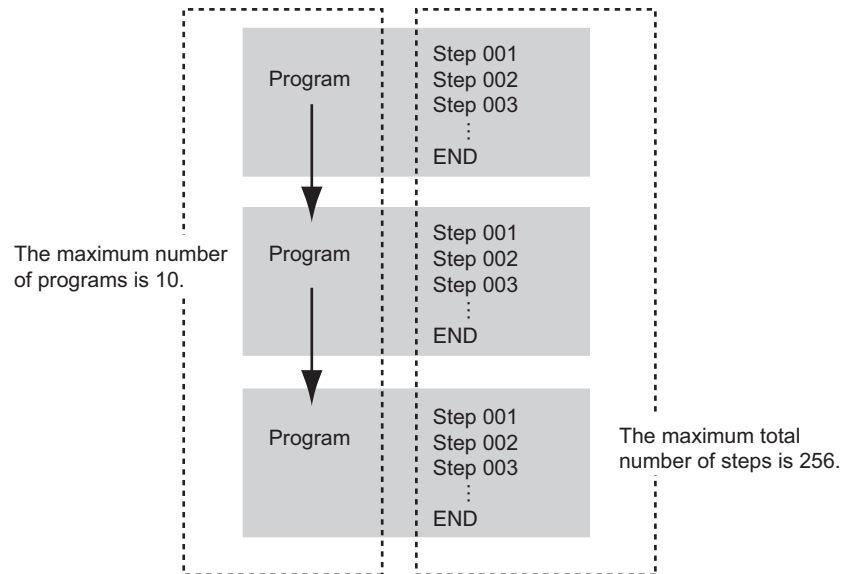

First configure the program settings, and then configure the step settings.

The details of the method for configuring a normal sequence are explained in "Sequence Example (Normal Sequence)".

See p. 66

## Editing Programs in a Normal Sequence

To configure a program, select one of four operation modes (CC, CR, CV, or CP). You can execute the same program repeatedly. You can also continue program execution by linking a program to another program. Linked programs can only be executed if they have the same operation mode and range. You can save up to 10 programs (No.1 to 10).

Press EDIT (SHIFT+A) to display a screen for configuring the programs in the sequence.

In the top screen, if you press ▼ when the cursor is at Loop, the bottom screen appears. In the bottom screen, if you press ▲ when the cursor is at Last Load, the top screen appears.

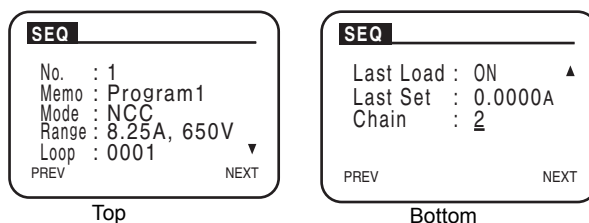

In the screens for configuring the programs in the sequence, you can configure the following items.

After you finish configuring the program settings, press NEXT (SHIFT+▶) to configure the step settings.

Item	Setting	Description
No.	1 to 10	Program number (11 is for the fast sequence)
Memo	Up to 11 characters	A memo
Mode	NCC: CC mode NCR: CR mode NCV: CV mode NCP: CP mode	The program operation mode
Range	8.25 A, 650 V (example)	The current and voltage ranges for the program vary depending on the model.
Loop	1 to 9998 9999: Infinite repetition	The number of times that the program will repeat.
Last Load	OFF: Load off ON: Load on	The state of the load (on or off) after the sequence finishes.
Last Set	0 to 100 % of the range	The fundamental setting at the end of the sequence. This setting is valid when Chain is set to OFF.
Chain	OFF: The sequence ends 1 to 10	Specifies the program that will be executed next. Only programs with the same operation mode and range can be executed.

# Editing Steps in a Normal Sequence

After you finish configuring the program settings, press NEXT (SHIFT+▶) to configure the step settings.

You can specify one execution condition per step. One step corresponds to one executed operation in the executed waveform.

## Adding steps

When you press INS (SHIFT+▲), a step is inserted above the currently highlighted step. Insert the number of steps that you want to execute. You can specify up to 256 steps for all of the up to 10 programs in a normal sequence.

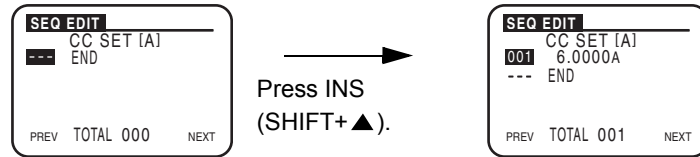

## Editing steps

After you have added steps, press ▼ and ▲ to highlight the step that you want to edit. There are three screens for editing steps. You can switch between screens by pressing NEXT (SHIFT+▶) and PREV (SHIFT+◀).

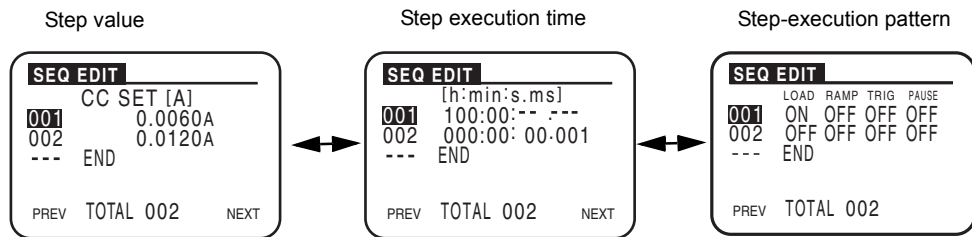

Step Editing Screen	Contents
Step value	The fundamental setting
Step execution time	The time for which the step will be executed
Step-execution pattern	Load on/off, ramp (step transition), trigger signal during step execution, and pause

### Step value

Set the fundamental setting (current, conductance, voltage, or power) value.

### Step execution time

Set the time for which the step is executed (0:00:00.001 to 999:59).

### Step-execution pattern

Set the execution pattern.

Item	Setting	Description
LOAD	ON: Load on, OFF: Load off	Turns the load on or off.
RAMP	ON: Slope, OFF: Step	The ramp (step transition)
TRIG	ON: Output, OFF: Don't output	The trigger signal during step execution
PAUSE	ON: Pause, OFF: Don't pause	Whether or not to pause

#### RAMP

Use this setting to specify the step transition. If you set RAMP to ON, the current changes in a slope within the step; if you set it to OFF, the current changes instantly and is sustained throughout the step.

Example: Setting: 10 A  
Step transition (RAMP OFF)  
Step execution time: 1 s

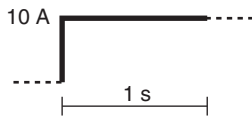

Example: Setting: 10 A  
Ramp transition (RAMP ON)  
Step execution time: 1 s

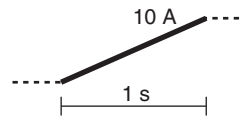

#### TRIG

Use this setting to specify whether or not to produce a trigger signal. If you set TRIG to ON, the TRIG OUT terminal on the front panel produces a trigger signal when the step is executed.

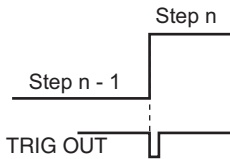

Example: Set trigger output at step number n (TRIG ON).

#### PAUSE

Use this setting to specify whether or not to pause the program. If you set PAUSE to ON, the sequence is paused after the step is executed. To unpause the sequence, press PAUSE (SHIFT+C) on the front panel, or apply a trigger signal to the TRIG INPUT pin (pin 11) of the EXT CONT connector.

See p. 97

Example: Pause and resume using the PAUSE (SHIFT+C) key.

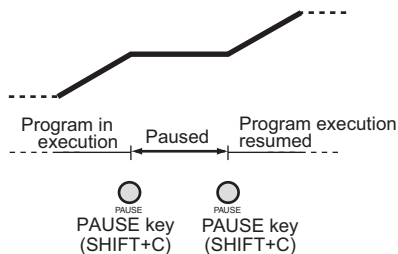

Example: Pause by executing PAUSE in a program, and resume using trigger input (TRIG IN).

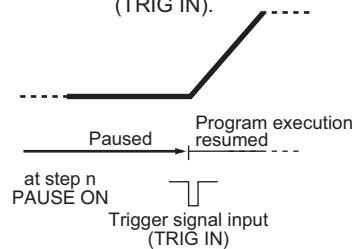

## Deleting steps

Press ▼ and ▲ to highlight the step that you want to delete, and then press DEL (SHIFT+▼). The highlighted step is deleted.

# Sequence Example (Normal Sequence)

This section explains how to use the operation panel to enter the following example sequence.

This section provides an example of how to execute a sequence with two programs on the PLZ164WH.

- Program 1

Memo: PROGRAM1, Mode: CC, Loop: 1, Chain: Program 2

Step	Setting	Step Execution Time	LOAD	RAMP	TRIG
Step 1	6 A	200 s (3 min 20 s)	On	On	Off
Step 2	6 A	150 s (2 min 30 s)	On	Off	Off
Step 3	0.3 A	80 s (1 min 20 s)	Off	Off	On

- Program 2

Memo: PROGRAM2, Mode: CC, Loop: 2

State that the load will be in after the sequence ends: Off, Current at the end of the sequence: 0 A, Chain: Off

Step	Setting	Step Execution Time	LOAD	RAMP	TRIG
Step 1	8.1 A	200 s (3 min 20 s)	On	On	Off
Step 2	3 A	50 s	On	Off	Off
Step 3	7.2 A	150 s (2 min 30 s)	On	On	Off

Program 2 starts after the three steps in program 1 have been executed. When the three steps in program 2 have been executed, the first execution of program 2 is finished. The sequence is complete when the second execution of program 2 is finished.

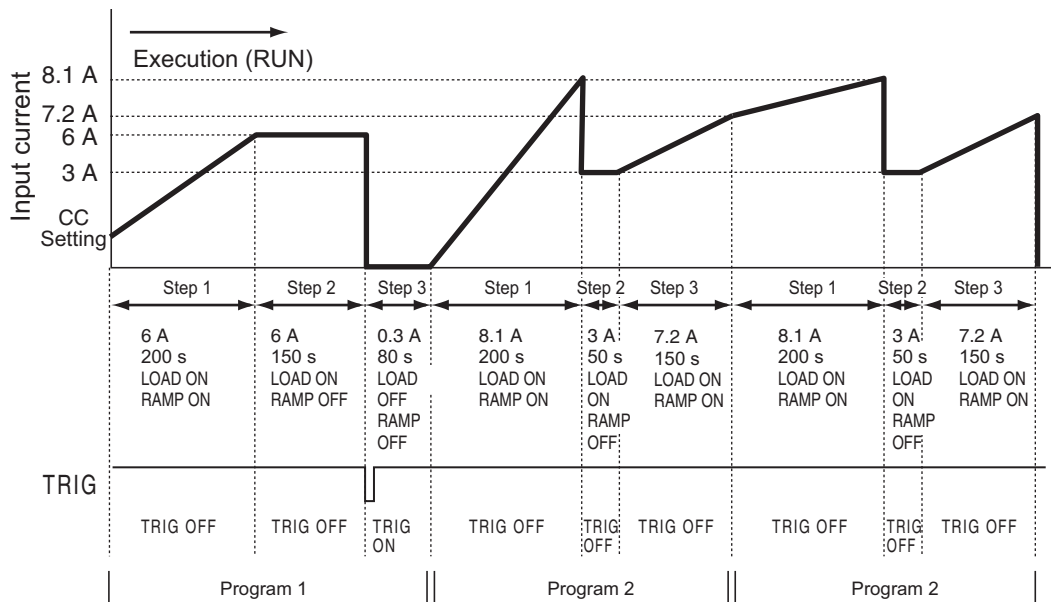

## Editing program 1

In this example, program 1 will be created first and then program 2. You can edit the programs in any order that you like. It is OK to create program 2 first and then create program 1.

### ★ Memo

You can move the cursor by pressing ▲, ▼, ◀, and ▶.  
To exit the sequence editing screens, press PREV (SHIFT+◀).

```

SEQ
-----
No.   : 1
Memo  :
Mode  : NCC
Range : 8.25A, 650V
Loop  : 0001
PREV  NEXT
  
```

### 1 Press EDIT (SHIFT+A).

The program editing screen appears.

### 2 Set the program number to 1.

If the cursor is not blinking at No., press ▲ and ▼ to move it there. Turn the rotary knob to select the number.

```

SEQ
-----
No.   : 1
Memo  : Program1
Mode  : NCC
Range : 8.25A, 650V
Loop  : 0001
PREV  NEXT
  
```

### 3 Press ▼ to move the cursor to Memo, and enter "Program1."

Enter the text using the rotary knob and ◀ and ▶.

### 4 Press ▼ to move the cursor to Mode, and select an operation mode (CC mode).

Turn the rotary knob to select NCC.

### 5 Press ▼ to move the cursor to Range, and set the current and voltage ranges (8.25 A and 650 V).

Turn the rotary knob to select 8.25 A, 650 V.

### 6 Press ▼ to move the cursor to Loop, and set the number of times to execute the program to 1.

Turn the rotary knob to select the number.

```

SEQ
-----
Last Load : OFF
Last Set  : 0.0000A
Chain     : OFF
PREV      NEXT
  
```

### 7 Press ▼ to move the cursor to Last Load, and select the state that the load will be in after the sequence ends (select OFF).

In this example, program 2 will be executed after program 1, so this setting is ignored.

### 8 Press ▼ to move the cursor to Last Set, and select the current that the load will supply after the sequence ends (select 0 A).

In this example, program 2 will be executed after program 1, so this setting is ignored.

### 9 Press ▼ to move the cursor to Chain, and set the number of the program to execute next to 2.

To execute program 2 next, select 2.

### 10 Press NEXT (SHIFT+▶) or ENTER.

The step value screen appears.

Before you set the steps for program 1, you can also configure program 2.

## Setting the steps of program 1

Set the current, execution time, and execution pattern of each step in program 1. The various items are set on separate screens. In this example the settings will be configured in the following order: current setting, execution time, and then execution pattern.

### Setting the current

**★ Memo**

You can move the cursor by pressing ▲ and ▼. Press PREV (SHIFT+◀) to return to the previous screen. Press DEL (SHIFT+▼) to delete a step.

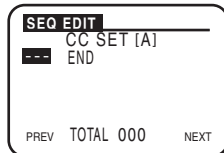

- 1 Press INS (SHIFT+▲).**  
Step 001 is inserted into the line with the highlighted dashes.

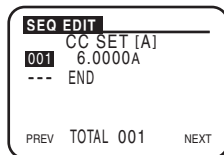

- 2 Set the current for step 1 to 6 A.**  
Turn the rotary knob to select 6.0000 A.

- 3 Press ▼ to highlight the dashes, and then press INS (SHIFT+▲).**  
Step 002 is inserted.

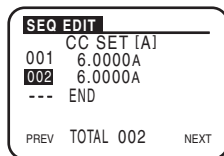

- 4 Set the current for step 2 to 6 A.**  
Turn the rotary knob to select 6.0000 A.

- 5 Set the current for step 3 to 0.3 A in the same manner as step 2.**

- 6 Press NEXT (SHIFT+▶) or ENTER.**  
The step execution time screen appears.

### Setting the execution time

**★ Memo**

You can move the cursor by pressing ▲, ▼, ◀, and ▶. Press PREV (SHIFT+◀) to return to the previous screen.

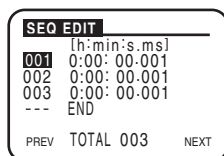

- 1 Press ▲ to move the cursor to step 001.**  
At first, the execution time is 0:00:00.001.

- 2 Set the execution time for step 1 to 3 min 20 s.**  
You can press ◀ and ▶ to move the cursor to the digit that you want to change. Turn the rotary knob to select 0:03:20.--.

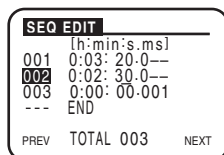

- 3 Press ▼ to move the cursor to step 002. Set the execution time for step 2 to 2 min 30 s in the same manner that you set it for step 1.**

- 4 Press ▼ to move the cursor to step 003. Set the execution time for step 3 to 1 min 20 s in the same manner that you set it for step 1.**

- 5 Press NEXT (SHIFT+▶) or ENTER.**  
The next editing screen appears.



## Setting the execution pattern

### ★ Memo

You can move the cursor by pressing ▲, ▼, ◀, and ▶.

Press PREV (SHIFT+◀) to return to the previous screen.

SEQ EDIT				
	LOAD	RAMP	TRIG	PAUSE
001	ON	ON	OFF	OFF
002	ON	OFF	OFF	OFF
003	OFF	OFF	ON	OFF
---	END			
PREV	TOTAL 003			

1  
2

Press ▲ to move the cursor to step 001.

For step 1, set LOAD and RAMP to ON.

◀ Press ▶ to move the cursor to the item that you want to set.

Turn the rotary knob to choose a setting. Leave TRIG and PAUSE set to OFF.

3

Press ▼ to move the cursor to step 002. For step 2, set LOAD to ON.

Leave RAMP, TRIG, and PAUSE set to OFF.

4

Press ▼ to move the cursor to step 003. For step 3, set TRIG to ON.

Leave LOAD, RAMP, and PAUSE set to OFF. All the settings for program 1 have been entered. Next we will edit program 2.

4

Sequences

## Editing program 2

After you finish editing program 1, edit program 2.

### ★ Memo

You can move the cursor by pressing ▲, ▼, ◀, and ▶.  
To exit the sequence editing screens, press PREV (SHIFT+◀).

**1 Press PREV (SHIFT+◀) three times to display the program editing screen.**

**2 Set the program number to 2.**

If the cursor is not blinking at No., press ▲ and ▼ to move it there. Turn the rotary knob to select 2.

**3 Press ▼ to move the cursor to Memo, and enter "Program2."**

Enter the text using the rotary knob and ◀ and ▶.

**4 Press ▼ to move the cursor to Mode, and select an operation mode (NCC mode).**

**5 Press ▼ to move the cursor to Range, and set the current and voltage ranges to 8.25 A and 650 V.**

**6 Press ▼ to move the cursor to Loop, and set the number of times to execute the program to 2.**

**7 Press ▼ to move the cursor to Last Load, and select the state that the load will be in after the sequence ends (select OFF).**

**8 Press ▼ to move the cursor to Last Set, and select the current that the load will supply after the sequence ends (select 0 A).**

**9 Press ▼ to move the cursor to Chain, and set it to OFF.**

To end the sequence after program 2 is executed twice, select OFF.

**10 Press NEXT (SHIFT+▶) or ENTER.**

The step value screen appears.

## Setting the steps of program 2

The settings will be configured in the same order as they were for program 1.

### ★ Memo

You can move the cursor by pressing ▲, ▼, ◀, and ▶.

Press NEXT (SHIFT+▶) to move to the next screen.

Press PREV (SHIFT+◀) to return to the previous screen.

```

SEQ EDIT
  CC SET [A]
001  8.1000A
002  3.0000A
003  7.2000A
---  END
PREV  TOTAL 003  NEXT
  
```

1

### Set the currents for steps 1 to 3.

Set the current for step 1 to 8.1 A, for step 2 to 3 A, and for step 3 to 7.2 A.

```

SEQ EDIT
  [h:min:s.ms]
001  0:03:20--
002  0:00:5000
003  0:02:30--
---  END
PREV  TOTAL 003  NEXT
  
```

2

### Set the execution times for steps 1 to 3.

Set the execution time for step 1 to 3 min 20 s; for step 2 to 50 s, and for step 3 to 2 min 30 s.

```

SEQ EDIT
  LOAD  RAMP  TRIG  PAUSE
001  ON  ON  OFF  OFF
002  ON  OFF  OFF  OFF
003  ON  ON  OFF  OFF
---  END
PREV  TOTAL 003
  
```

3

### Set the execution patterns for steps 1 to 3.

For step 1, set LOAD to ON, RAMP to ON, TRIG to OFF, and PAUSE to OFF. For step 2, set LOAD to ON, RAMP to OFF, TRIG to OFF, and PAUSE to OFF. For step 3, set LOAD to ON, RAMP to ON, TRIG to OFF, and PAUSE to OFF.

All the settings for program 2 have been entered.

4

### Press PREV (SHIFT+) four times to exit the sequence editing screen.

Each time you press PREV (SHIFT+), the previous screen is displayed. Keep pressing PREV (SHIFT+◀) until the screen that was displayed before you started sequence editing appears.

# How Fast Sequences Work

The operation modes that you can execute fast sequences in are constant current (CC) mode and constant resistance (CR) mode.

Just like normal sequences, fast sequences are composed of two elements: programs and steps.

Programs are groups of executable units called steps. When program 11 is executed, its steps are executed in order, starting with step 0001. A single execution of a program is completed after the program's last step has been executed.

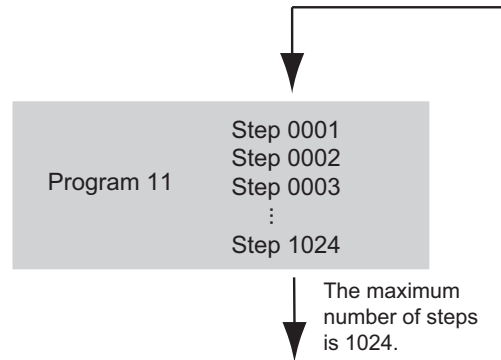

First configure the program settings, and then configure the step settings.

The details of the method for configuring a fast sequence are explained in "Sequence Example (Fast Sequence)".

 p. 76

## Editing a Fast-Sequence Program

To configure a fast-sequence program, you first need to set the operation mode to CC mode or CR mode. The program is executed the specified number of times.

Unlike with normal sequences, you cannot chain programs to be executed after the first program. You can save one program (No. 11).

Press EDIT (SHIFT+A) to display a screen for configuring the sequence's program operation. In the top screen, if you press ▼ when the cursor is at Loop, the bottom screen appears. In the bottom screen, if you press ▲ when the cursor is at Last Load, the top screen appears.

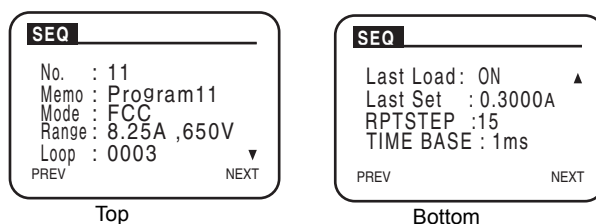

In the screens for configuring the programs in the sequence, you can configure the following items.

After you finish configuring the program settings, press NEXT (SHIFT+▶) to configure the step settings.

Item	Setting	Description
No.	11	Program number (1 to 10 are for the normal sequences)
Memo	Up to 11 characters	A memo
Mode	FCC: CC mode FCR: CR mode	The program operation mode
Range	8.25A,650V (example)	The current and voltage ranges for the program vary depending on the model.
Loop	1 to 9998 9999: Infinite repetition	The number of times that the program will repeat
Last Load	OFF: Load off ON: Load on	The state of the load (on or off) after the sequence finishes
Last Set	0 to 100 % of the range	The current at the end of the sequence
RPTSTEP	3 to 1024 <sup>1</sup>	The last step number
TIME BASE	0.1 ms to 100 ms	Step execution time

<sup>1</sup> The minimum number of steps in a fast sequence is 3.

# Editing Steps in a Fast Sequence

After you finish configuring the program settings, press NEXT (SHIFT+▶) to configure the step settings.

You can specify one execution condition (current and trigger output) per step. One step corresponds to one executed operation in the executed waveform.

The minimum number of steps in a fast sequence is 3. Even if you only specify settings for step 1 and step 2, when you execute a fast sequence, a step 3 will also be executed.

## Editing steps

The number of steps that can be monitored is determined by the RPTSTEP setting (last step) that you specified when you edited the program.

Configure the following step settings in the monitor screen.

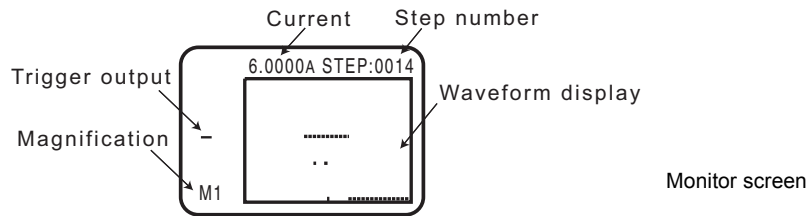

Item	Setting	Description
STEP	1 to 1024	Step number
Current or conductance	0 to 100 % of the range	The current or conductance that is produced at the step
Trigger output	_: Off T: On	The trigger signal during step execution

Each time you press ▼, the cursor moves between items in this order: step number, current, trigger output setting, and then magnification.

Each time you press ▲, the cursor moves between items in this order: magnification, trigger output setting, current, and then step number.

You can use the FILL function to set multiple steps at once.

### ■ Trigger output (TRIG)

Use this setting to specify whether or not to produce a trigger signal. If you set TRIG to ON, the TRIG OUT terminal on the front panel produces a trigger signal when the step is executed.

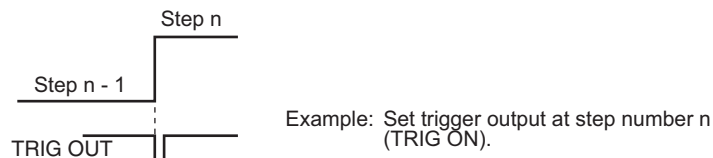

### Increasing the magnification in the step setting monitor screen

See p. 75

You can increase the magnification that the steps are monitored at.

Press ▼ to move the cursor to the magnification, and use the rotary knob to change the magnification. There are eight magnifications, from M1 to M8. The numbers indicate the number of steps that are displayed on a single screen. M1 is the maximum magnification.

When you move the cursor to the step number by pressing ▲ and then change the step using the rotary knob, the waveform moves so that the selected step is in the center of the rectangular monitor area.

When the magnification is set to M1, you can use the rotary knob to move one step at a time and monitor the steps in detail. In the same way, when the magnification is M2, you can move by two steps at a time; when the magnification is M3, you can move by three steps at a time; and when the magnification is M8, you can move by eight steps at a time.

You can monitor all the steps up to the specified last step.

Press PREV (SHIFT+◀) to return to the previous screen.

### FILL function

See p. 75

You can use the FILL function to automatically set the currents of a group of steps by setting the currents of the step on each end of the group.

In the monitor screen, press INS (SHIFT+▲) to display the FILL screen.

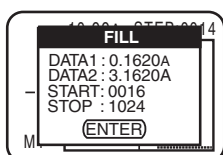

Item	Setting	Description
DATA1	0 to 100 % of the range	The current of the first step
DATA2	0 to 100 % of the range	The current of the last step
START	1 to 1024	The step number of the first step
STOP	1 to 1024 <sup>1</sup>	The step number of the last step

<sup>1</sup> You can set the number of the last step to any value up to 1024, but the last step that can be monitored is determined by the value that you set for RPTSTEP.

**★ Memo**

You can set the number of the last step to any value up to 1024, but the last step that can be monitored is determined by the value that you set for RPTSTEP when you edited the program.

Press ▼ or ▲ to move the cursor to DATA1, and use the rotary knob to set the current of the first step. In the same way, set DATA2 (the current of the last step), START (the step number of the first step), and STOP (the step number of the last step).

After you have finished making the settings, press ENTER to return to the monitor screen.

In the example in the figure below, the same waveform is repeated twice.

First, set the first step to 16 and the current to 0.162 A, and set the last step to 100 and the current to 1.164 A. Then, set the first step to 101 and the current to 0.164 A, and set the last step to 200 and the current to 1.164 A.

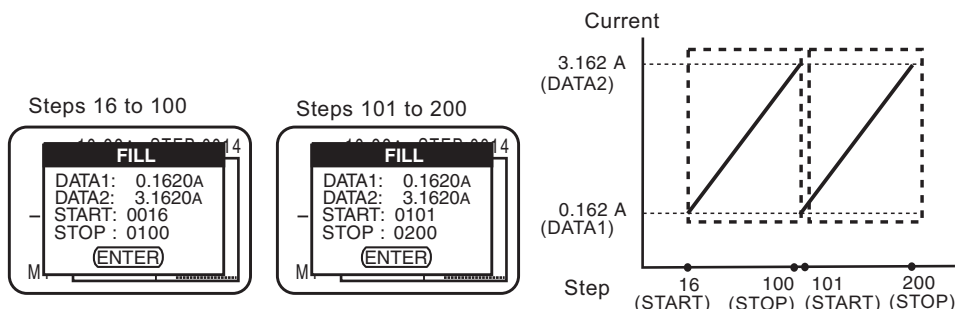

# Sequence Example (Fast Sequence)

This section explains how to use the operation panel to enter the following example sequence.

This section provides an example of how to execute a sequence on the PLZ164WH that will simulate the waveform shown in the figure below.

- Program 11

Memo: PROGRAM11, Mode: CC, Loop: 3, State that the load will be in after the sequence ends: On, Current at the end of the sequence: 0.3 A, Last step number: 15, Step execution time: 1 ms

Step	Setting	Trigger Output
Steps 1 to 5	6 A	Off
Step 6	3 A	On
Steps 7 to 10	6 A	Off
Step 11	3 A	Off
Steps 12 to 15	6 A	Off

When you execute the sequence, program 11 will be repeated three times (point A to B, point B to C, point C to D). After program 11 has been executed 3 times, it will finish, and the current will change to 0.3 A (point E).

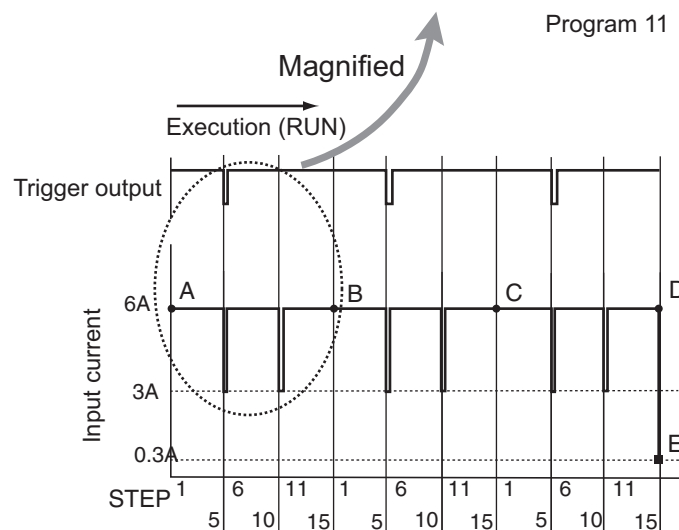
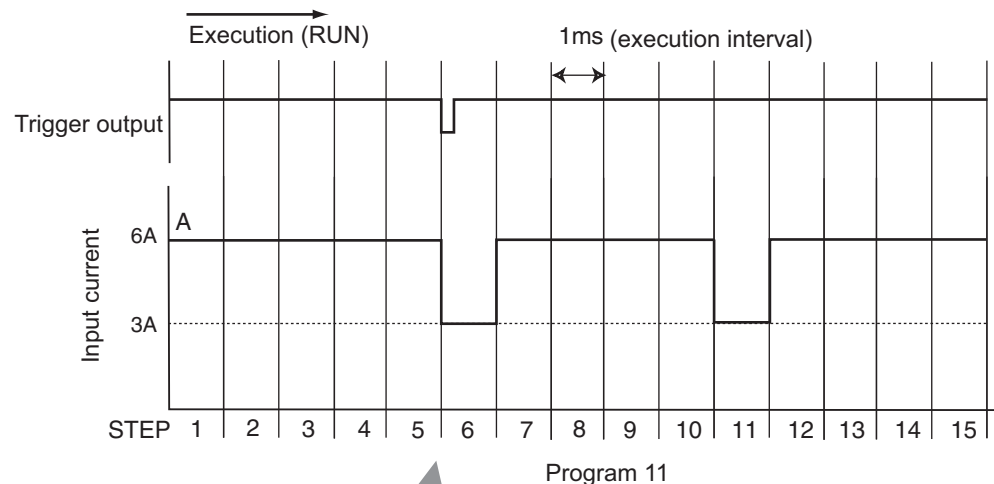



## Editing program 11

### ★ Memo

You can move the cursor by pressing ▲, ▼, ◀, and ▶.

To exit the sequence editing screens, press PREV (SHIFT+◀).

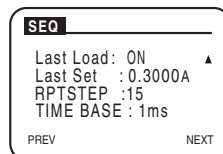
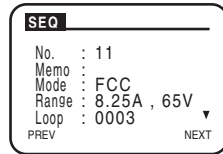

- 1 Press EDIT (SHIFT+A).**  
The program editing screen appears.
- 2 Set the program number to 11.**  
If the cursor is not blinking at No., press ▲ and ▼ to move it there. Turn the rotary knob to select the number.
- 3 Press ▼ to move the cursor to Memo, and enter "Program11."**  
Enter the text using the rotary knob and ◀ and ▶.
- 4 Press ▼ to move the cursor to Mode, and select an operation mode (CC mode).**  
Turn the rotary knob to select FCC.
- 5 Press ▼ to move the cursor to Range, and set the current and voltage ranges to 8.25 A and 65 V.**  
Turn the rotary knob to select 8.25 A, 65 V.
- 6 Press ▼ to move the cursor to Loop, and set the number of times to execute the program to 3.**  
Turn the rotary knob to select the number.
- 7 Press ▼ to move the cursor to Last Load, and select the state that the load will be in after the sequence ends (select ON).**  
Turn the rotary knob to select ON.
- 8 Press ▼ to move the cursor to Last Set, and select the current that the load will supply after the sequence ends (select 0.3 A).**  
Turn the rotary knob to select the number.
- 9 Press ▼ to move the cursor to RPTSTEP, and set the step number of the last step to 15.**  
Turn the rotary knob to select the number.
- 10 Press ▼ to move the cursor to TIME BASE, and set the step execution time to 1 ms.**  
Turn the rotary knob to set the time.
- 11 Press NEXT (SHIFT+▶) or ENTER.**  
The step value screen appears.

## Setting the steps of program 11

Set the current and trigger output of each step in program 11. In this example the current will be set first, followed by the trigger output.

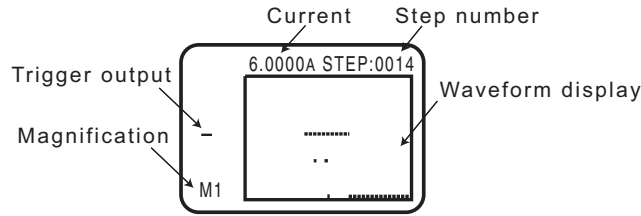

Each time you press ▼, the cursor moves between items in this order: step number, current, trigger output setting, and then magnification.

Each time you press ▲, the cursor moves between items in this order: magnification, trigger output setting, current, and then step number.

### ★ Memo

You can move the cursor by pressing ▲ and ▼. Press PREV (SHIFT+◀) to return to the previous screen.

- 1 Make sure that the cursor is blinking at STEP.**  
If the cursor is not blinking at STEP, press ▲ and ▼ to move it there.
- 2 Turn the rotary knob to set the step number to 1.**
- 3 Press ▼ to move the cursor to the current, and turn the rotary knob to set the value to 6 A.**
- 4 Press ▲ to move the cursor to STEP.**
- 5 Set the currents for steps 2 through 5 to 6 A in the same way that you set step 1.**
- 6 Set the current for step 6 to 3 A.**
- 7 Press ▼ to move the cursor to the trigger output setting, and turn the rotary knob to select T.**
- 8 Set the currents for steps 7 to 10 to 6 A.**
- 9 Set the current for step 11 to 3 A.**
- 10 Set the currents for steps 12 to 15 to 6 A.**  
All the settings for program 2 have been entered.
- 11 Press PREV (SHIFT+◀) twice to display the sequence editing screen.**  
Each time you press PREV (SHIFT+◀), the previous screen is displayed. Keep pressing PREV (SHIFT+◀) until the screen that was displayed before you started sequence editing appears.

# Executing, Pausing, and Stopping Sequences

After you have finished configuring the sequence, execute it.

## Executing sequences

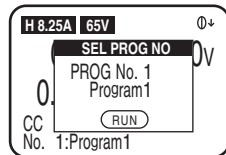

- 1 Make sure that the switching and short functions are off.**  
Make sure that the SW ON key light is off and that the short icon is not displayed. Even if the light is on, when you enter the sequence execution screen, the switching and short functions will be turned off automatically.
- 2 Press RUN/STOP (SHIFT+B) or PAUSE (SHIFT+C) to display the sequence execution screen.**
- 3 Turn the rotary knob to select the number of the program that you want to execute.**  
To execute a normal sequence, select a program number from 1 to 10. To execute a fast sequence, select program number 11.
- 4 Press RUN/STOP (SHIFT+B) to execute the selected sequence.**  
The sequence will be executed, and the measured values will appear on the display. When the sequence is completed, a popup window appears on the screen.
- 5 Press ENTER to exit the sequence execution screen.**

### ★ Memo

Press PREV (SHIFT+◀) to return to the previous screen.

If a step's PAUSE setting has been set to ON, the sequence operation will pause after the step has been executed. To resume operation, press PAUSE (SHIFT+C).

## Pausing a sequence

If you press PAUSE (SHIFT+C) while a sequence is being executed, the sequence pauses, and the PAUSE screen appears.

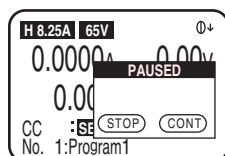

To resume the sequence, press PAUSE (SHIFT+C) again.

If you press RUN/STOP (SHIFT+B) while the sequence is paused, the sequence will stop.

## Stopping a sequence

If you press RUN/STOP (SHIFT+B) while a sequence is being executed, the sequence will stop.

If you press RUN/STOP (SHIFT+B) again after stopping the sequence, the sequence will start over again from the beginning of the selected program.

## When sequences cannot be executed

You cannot execute programs together in a sequence if their modes and ranges do not match.

When the load is on, if the current mode and range do not match those of the sequence that you are trying to execute, you will be unable to execute the sequence. First turn off the load, and then set the mode and range to match those of the sequence that you want to execute.

When the load is off, if the current mode and range settings do not match those of the sequence that you are trying to execute, the settings of the sequence are automatically changed to match the current settings.

Before Sequence Execution		Sequence Execution	
Load on/off state	Mode and range settings of the sequence that you are trying to execute	Execution	Mode and range settings that are executed
Load on	Match the current settings	Possible	Same as the current settings
	Do not match the current settings	Not possible	_____
Load off	Match the current settings	Possible	Same as the current settings
	Do not match the current settings	Possible	Automatically changed to the current settings



# 5

---

## External Control and Parallel Operation

This chapter explains external control and  
Parallel Operation.

# External Control

The settings in each operation mode normally use the internal reference signal. In external control, the reference signal is supplied externally. The external signal is supplied as a voltage (analog voltage control) or resistance (resistance control). In addition, digital control, such as the turning on and off of the load, can be performed, and signals that indicate the status can be produced.

The EXT CONT connector is used for external control.

## Analog Voltage Control

CC, CP, CR, and CV mode values

## Resistance Control

CC, CP, CR, and CV mode values

## Digital Control

Turning the load on and off and monitoring its status

Range control for each operation mode

Unpausing during sequence operation

Forced alarm generation

Alarm clearing

## Signal Output

Load on/off status signals

Range monitoring for each operation mode

Input current monitoring

Input voltage monitoring

Relay contact output for the short function

## Precautions for high-speed load simulations

During high-speed load simulation, do not connect the common terminal of the external device to the terminal of the DUT (the terminal that is connected to the negative input terminal of the PLZ-4WH). Attach a commercially available ferrite core to the wiring between the PLZ-4WH and the external device.

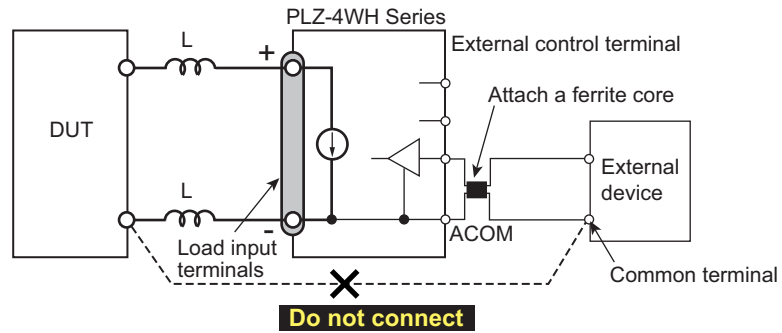

## About the EXT CONT connector

To control the PLZ-4WH externally, use the EXT CONT connector.

A protective socket is attached to the EXT CONT connector when the PLZ-4WH is in the factory default state. Keep the protective socket in a safe place so that you can attach it to the EXT CONT connector when the connector is not in use. If the protective socket is damaged or lost, contact your Kikusui agent or distributor.

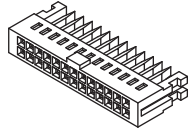

Protective socket for J1  
[84-49-0071]



**Possible electric shock. The EXT CONT connector contains pins that have the same potential as the output terminal. When the EXT CONT connector is not in use, be sure to attach the protective socket that comes with the PLZ-4WH.**

Be sure to turn off the PLZ-4WH's power switch before you attach or remove connectors. When you remove a connector, first release the lock lever on each side of the connector, and then pull from the connector.

The connector parts needed to connect the EXT CONT connector (standard MIL 20-pin connector) are not provided. The recommended connectors are shown in the following table.

Manufacturer	Product	Notes
Omron	XG5M-2032 or XG5M-2035 XG5S-1001 (2 pcs.)	For discrete wires
Omron	XG4M-2030, XG4T-2004	For flat cables
KEL	6200-020-601	For flat cables

For information about how to use these tools and components, see the OMRON Corporation or KEL Corporation catalogs.

When using a flat cable, be sure to use a connector with a strain relief.

To press-fit discrete wires or flat cables, be sure to use a special tool. For a description of applicable cables and tools, see the catalog of the relevant connector manufacturer.

See p. 148

An optional OP01-PLZ-4W External Control Connector Kit is available for making the connection.

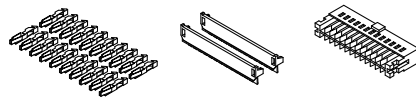



## EXT CONT connector pin arrangement

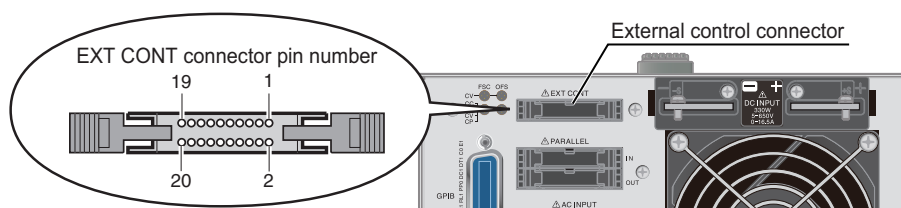

Pin No.	Signal Name	Description
1	EXT R/V CONT	For controlling CC, CR, CP, and CV modes through external voltage. Voltage Control External input voltages in the range of 0 V to 10 V correspond to 0 % to 100 % of the rated current (CC mode), rated power (CP mode), or rated voltage (CV mode). In CR mode, external input voltages in the range of 0 V to 10 V correspond to the range of resistances from the maximum resistance to the minimum resistance. Resistance Control External resistances in the range of 0 $\Omega$ to 10 k $\Omega$ correspond to 0 % to 100 % or 100 % to 0 % of the rated current (CC mode), rated power (CP mode), or rated voltage (CV mode). In CR mode, external resistances in the range of 0 $\Omega$ to 10 k $\Omega$ correspond to the range of resistances from the maximum resistance to the minimum resistance or from the minimum resistance to the maximum resistance.
2	IMON	Current monitor output. 10 V for full scale (H/L range), 1 V for full scale (M range)
3	A COM	Connected to the negative load input terminal on the rear panel.
4	V MON	Voltage monitor output. 10 V for full scale
5	EXT V CONT CV	For controlling CV mode through external voltage. External input voltages in the range of 0 V to 10 V correspond to 0 % to 100 % of the rated voltage.
6	A COM	Connected to the negative load input terminal on the rear panel.
7	LOAD ON/OFF CONT	The load is turned on by a low (or high) CMOS level signal. The logic levels can be switched. The internal circuit is pulled up to 5 V by a 10 k $\Omega$ resistor.
8	RANGE CONT 1	Input for switching the range externally. <sup>1</sup> The internal circuit is pulled up to 5 V by a 10 k $\Omega$ resistor. Valid only when the front panel setting is H range.
9	RANGE CONT 0	Input for switching the range externally. <sup>1</sup> The internal circuit is pulled up to 5 V by a 10 k $\Omega$ resistor. Valid only when the front panel setting is H range.
10	ALARM INPUT	The alarm is activated by a low CMOS level signal. The internal circuit is pulled up to 5 V by a 10 k $\Omega$ resistor.
11	TRIG INPUT	Unpauses the PLZ-4WH if a low CMOS level signal is applied for 10 $\mu$ s or more. The internal circuit is pulled up to 5 V by a 10 k $\Omega$ resistor.
12	A COM	Connected to the negative load input terminal on the rear panel.
13	LOAD ON STATUS	Turns on when the load is on. Open collector output by a photocoupler. <sup>2</sup>
14	RANGE STATUS 1	Range status output. <sup>3</sup> Open collector output by a photocoupler. <sup>2</sup>
15	RANGE STATUS 0	Range status output. <sup>3</sup> Open collector output by a photocoupler. <sup>2</sup>
16	ALARM STATUS	Turns on when a protection function (OVP, OCP, OPP, OHP, REV, or UVP) is activated or when an external alarm is applied. Open collector output by a photocoupler. <sup>2</sup>
17	STATUS COM	STATUS signal common for pins 17 to 20.
18	N.C.	---
19	SHORT SIGNAL OUT	Relay contact output (30 VDC/1 A)
20	SHORT SIGNAL OUT	Relay contact output (30 VDC/1 A)

<sup>1</sup> Valid only when the front panel setting is H range.

	RANGE CONT 0	RANGE CONT 1
H range	H	H
M range	H	L
L range	L	H

<sup>2</sup> The maximum applied voltage of the photocoupler is 30 V, and the maximum current is 8 mA.

	RANGE STATUS 0	RANGE STATUS 1
H range	OFF	OFF
M range	OFF	ON
L range	ON	OFF

# Controlling Constant Current Mode (CC Mode) Externally

You can use an external voltage or an external resistance to control CC mode externally. The input current changes proportionally to the external voltage or external resistance.

To prevent damage from noise, use twisted signal wires.

By properly adjusting the OFS and FSC variable resistors on the rear panel, you will be able to control the input current proportionally to the external voltage or resistance.

See p. 95

## Control using an external voltage

When you apply an external voltage of 0 V to 10 V to the PLZ-4WH, the input current varies in accordance with the voltage.

An external voltage of 0 V results in an input current of 0 A. An external voltage of 10 V results in an input current of 100 % of the specified range. The precision of the PLZ-4WH cannot be guaranteed for voltages below 0 V or above 10 V.

Use a highly stable external voltage that has low noise.

### CAUTION

To avoid damaging the PLZ-4WH, observe the following precautions.

- The maximum voltage that can be applied across pins 1 and 3 of the EXT CONT connector is  $\pm 11$  V. Do not apply a voltage that exceeds this value.
- Pin 3 of the EXT CONT connector is connected the negative load input terminal. Make sure that the wire of pin 3 does not touch any of the other pins.

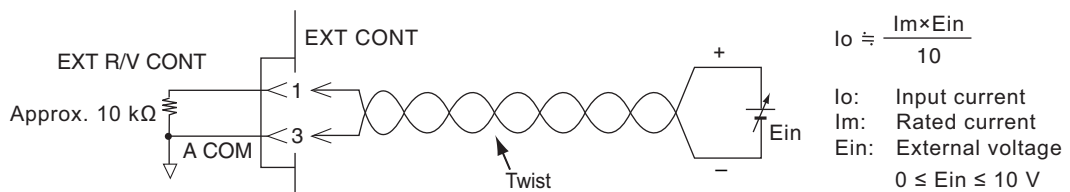
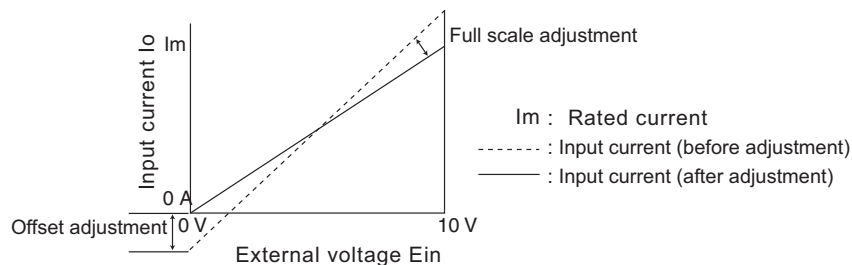

- 1 Turn the POWER switch off.**
- 2 Connect the external voltage across pins 1 and 3 of the EXT CONT connector.**
- 3 Turn the POWER switch on, and make sure that the load is off.**
- 4 Set the operation mode and the current range.**  
If you also want to control the current range externally, be sure to set the range to H.
- 5 From the menu, select "2. Configuration" > "3.External" > "Control" > "V."**

See p. 56

Doing so enables the external control of CC mode.

- 6 Turn the power switch off and then on again.**  
The menu settings are applied.

## Control using an external resistance

When you connect an external resistance of 0 Ω to 10 kΩ to the PLZ-4WH, the input current varies proportionally or inversely to the external resistance.

**Proportional control:** An external resistance of 0 Ω results in an input current of 0 A. An external resistance of 10 kΩ results in an input current of 100 % of the specified range.

**Inverse control:** An external resistance of 10 kΩ results in an input current of 0 A. An external resistance of 0 Ω results in an input current of 100 % of the specified range.

We recommend that the variable resistors that you connect to the PLZ-4WH be resistant to changes due to temperature and the passage of time. Examples of such resistors include wire wound and metal film resistors and multi-turn potentiometers. Use resistors that have a residual resistance of 50 Ω or less when set to the minimum resistance.

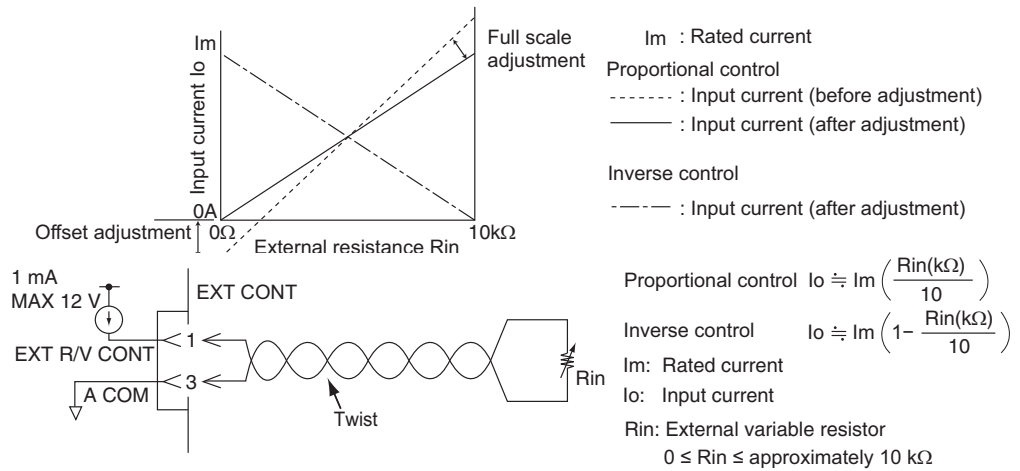

- 1 If you are performing proportional control, set the resistance to the minimum value. If you are performing inverse control, set the resistance to the maximum value.**
- 2 Turn the POWER switch off.**
- 3 Connect the external variable resistor across pins 1 and 3 of the EXT CONT connector.**
- 4 Turn the POWER switch on, and make sure that the load is off.**
- 5 Set the operation mode and the current.**  
If you also want to control the current range externally, be sure to set the range to H.
- 6 From the menu, select “2.Configuration” > “3.External” > “Control.” If you are performing proportional control, select “R.” If you are performing inverse control, select “Rinv.”**  
Doing so enables the external control of CC mode.
- 7 Turn the power switch off and then on again.**  
The menu settings are applied.

See p. 56

# Controlling Constant Resistance Mode (CR Mode) Externally

You can use an external voltage or an external resistance to control CR mode externally. The resistance changes proportionally to the external voltage or external resistance.

To prevent damage from noise, use twisted signal wires.

By properly adjusting the OFS and FSC variable resistors on the rear panel, you will be able to control the input current proportionally to the external voltage or resistance.

See p. 95

## Control using an external voltage

When you apply an external voltage of 0 V to 10 V to the PLZ-4WH, the resistance varies in accordance with the voltage.

An external voltage of 0 V results in the maximum resistance. An external voltage of 10 V results in the minimum resistance.

The precision of the PLZ-4WH cannot be guaranteed for voltages below 0 V or above 10 V. Use a highly stable external voltage that has low noise.

**CAUTION** To avoid damaging the PLZ-4WH, observe the following precautions.

- The maximum voltage that can be applied across pins 1 and 3 of the EXT CONT connector is  $\pm 11$  V. Do not apply a voltage that exceeds this value.
- Pin 3 of the EXT CONT connector is connected the negative load input terminal. Make sure that the wire of pin 3 does not touch any of the other pins.

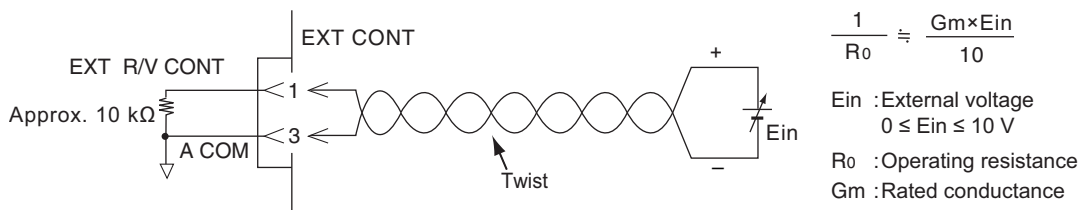
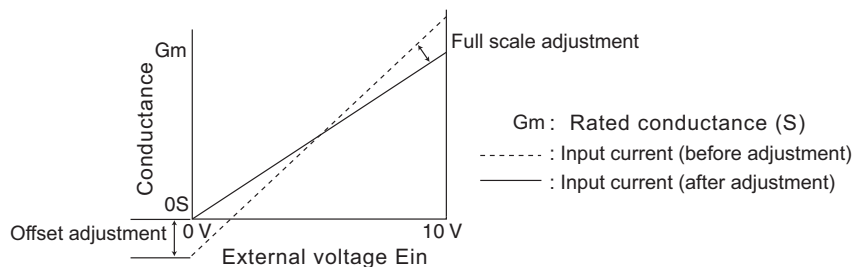

- 1 Turn the POWER switch off.**
- 2 Connect the external voltage across pins 1 and 3 of the EXT CONT connector.**
- 3 Turn the POWER switch on, and make sure that the load is off.**
- 4 Set the operation mode and the current range.**  
If you also want to control the current range externally, be sure to set the range to H.

See p. 56

**5 From the menu, select “2. Configuration” > “3.External” > “Control” > “V.”**

Doing so enables the external control of CR mode.

**6 Turn the power switch off and then on again.**

The menu settings are applied.

## Control using an external resistance

When you connect an external resistance of 0 Ω to 10 kΩ to the PLZ-4WH, the resistance varies proportionally or inversely to the external resistance.

**Proportional control:** An external resistance of 0 Ω results in the maximum resistance. An external resistance of 10 kΩ results in the minimum resistance.

**Inverse control:** An external resistance of 10 kΩ results in the maximum resistance. An external resistance of 0 Ω results in the minimum resistance.

We recommend that the variable resistors that you connect to the PLZ-4WH be resistant to changes due to temperature and the passage of time. Examples of such resistors include wire wound and metal film resistors and multi-turn potentiometers. Use resistors that have a residual resistance of 50 Ω or less when set to the minimum resistance.

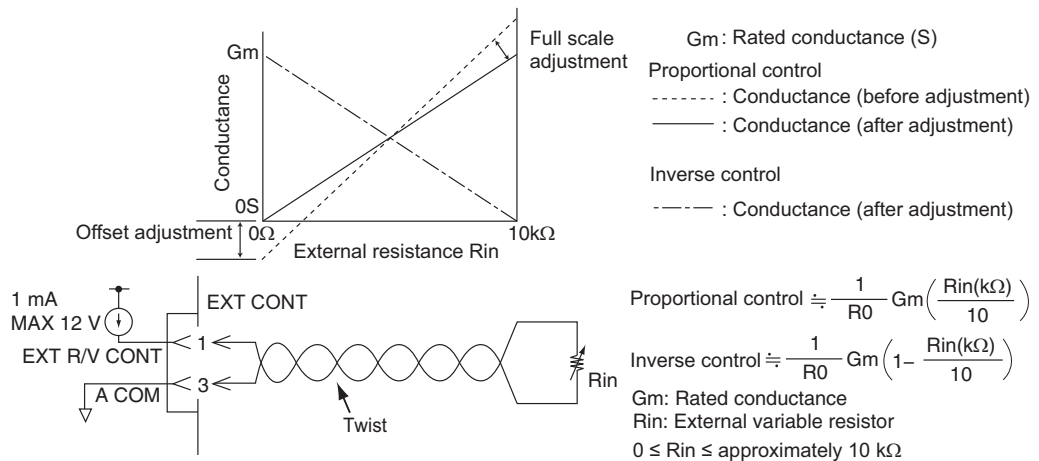

**1 If you are performing proportional control, set the resistance to the minimum value. If you are performing inverse control, set the resistance to the maximum value.**

**2 Turn the POWER switch off.**

**3 Connect the external variable resistor across pins 1 and 3 of the EXT CONT connector.**

**4 Turn the POWER switch on, and make sure that the load is off.**

**5 Set the operation mode and the current.**

If you also want to control the current range externally, be sure to set the range to H.

See p. 56

**6 From the menu, select “2.Configuration” > “3.External” > “Control.” If you are performing proportional control, select “R.” If you are performing inverse control, select “Rinv.”**

Doing so enables the external control of CR mode.

**7 Turn the power switch off and then on again.**

The menu settings are applied.

# Controlling Constant Power Mode (CP Mode) Externally

You can use an external voltage or an external resistance to control CP mode externally. The power changes proportionally to the external voltage or external resistance.

To prevent damage from noise, use twisted signal wires.

By properly adjusting the OFS and FSC variable resistors on the rear panel, you will be able to control the input current proportionally to the external voltage or resistance.

See p. 95

## Control using an external voltage

When you apply an external voltage of 0 V to 10 V to the PLZ-4WH, the power varies in accordance with the voltage.

An external voltage of 0 V results in a power of 0 W. An external voltage of 10 V results in a power of 100 % of the specified range. The precision of the PLZ-4WH cannot be guaranteed for voltages below 0 V or above 10 V.

Use a highly stable external voltage that has low noise.

### CAUTION

To avoid damaging the PLZ-4WH, observe the following precautions.

- The maximum voltage that can be applied across pins 1 and 3 of the EXT CONT connector is  $\pm 11$  V. Do not apply a voltage that exceeds this value.
- Pin 3 of the EXT CONT connector is connected the negative load input terminal. Make sure that the wire of pin 3 does not touch any of the other pins.

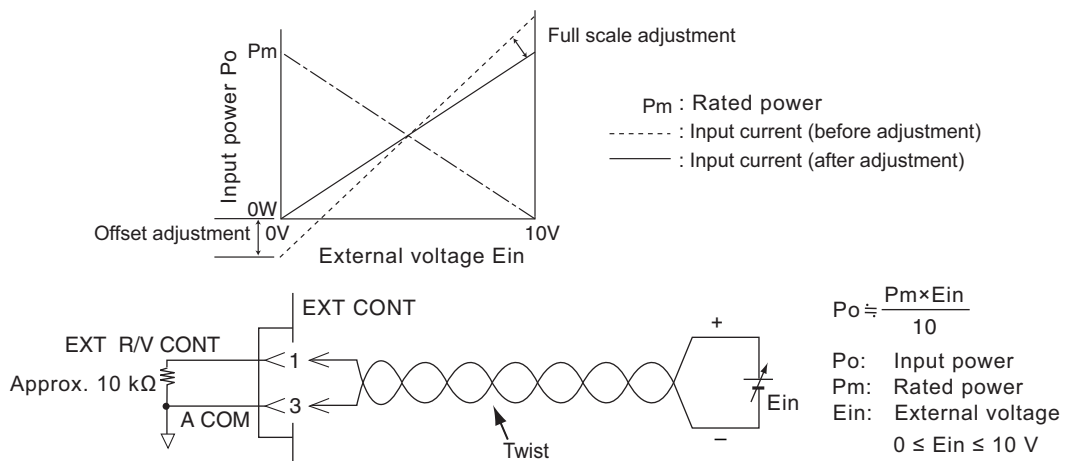

- 1 Turn the **POWER** switch off.
- 2 Connect the external voltage across pins 1 and 3 of the **EXT CONT** connector.
- 3 Turn the **POWER** switch on, and make sure that the load is off.
- 4 Set the operation mode and the current range.  
If you also want to control the current range externally, be sure to set the range to H.
- 5 From the menu, select “2. Configuration” > “3.External” > “Control” > “V.”

See p. 56

Doing so enables the external control of CP mode.

## 6 Turn the power switch off and then on again.

The menu settings are applied.

## Control using an external resistance

When you connect an external resistance of 0 Ω to 10 kΩ to the PLZ-4WH, the power varies proportionally or inversely to the external resistance.

**Proportional control:** An external resistance of 0 Ω results in a power of 0 W. An external resistance of 10 kΩ results in a power of 100 % of the specified range.

**Inverse control:** An external resistance of 10 kΩ results in a power of 0 W. An external resistance of 0 Ω results in a power of 100 % of the specified range.

We recommend that the variable resistors that you connect to the PLZ-4WH be resistant to changes due to temperature and the passage of time. Examples of such resistors include wire wound and metal film resistors and multi-turn potentiometers. Use resistors that have a residual resistance of 50 Ω or less when set to the minimum resistance.

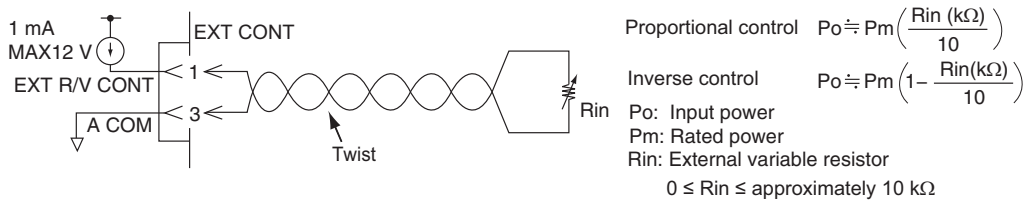
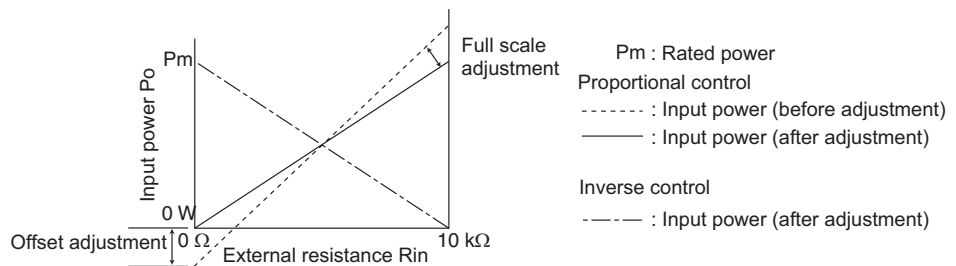

**1** If you are performing proportional control, set the resistance to the minimum value. If you are performing inverse control, set the resistance to the maximum value.

**2** Turn the POWER switch off.

**3** Connect the external variable resistor across pins 1 and 3 of the EXT CONT connector.

**4** Turn the POWER switch on, and make sure that the load is off.

**5** Set the operation mode and the current.

If you also want to control the current range externally, be sure to set the range to H.

**6** From the menu, select “2.Configuration” > “3.External” > “Control.” If you are performing proportional control, select “R.” If you are performing inverse control, select “Rinv.”

Doing so enables the external control of CP mode.

**7** Turn the power switch off and then on again.

The menu settings are applied.

See p. 56

# Controlling Voltage Mode (CV mode and the +CV modes)

You can use an external voltage or an external resistance to control CV mode externally. The voltage changes proportionally to the external voltage or external resistance.

You can use an external voltage to control the +CV modes externally. The voltage changes proportionally to the external voltage.

To prevent damage from noise, use twisted signal wires.

By properly adjusting the OFS and FSC variable resistors on the rear panel, you will be able to control the input current proportionally to the external voltage or resistance.

See p. 95

## Control using an external voltage

When you apply an external voltage of 0 V to 10 V to the PLZ-4WH, the voltage that it produces varies in accordance with the external voltage.

An external voltage of 0 V results in a voltage of 0 V. An external voltage of 10 V results in a voltage of 100 % of the specified range.

Use a highly stable external voltage that has low noise.

### CAUTION

To avoid damaging the PLZ-4WH, observe the following precautions.

- The maximum voltage that can be applied across pins 1 and 3 and across pins 5 and 6 of the EXT CONT connector is  $\pm 11$  V. Do not apply a voltage that exceeds this value.
- Pins 3 and 6 of the EXT CONT connector are connected to the negative load input terminal. Make sure that the wires of pins 3 and 6 do not touch any of the other pins.

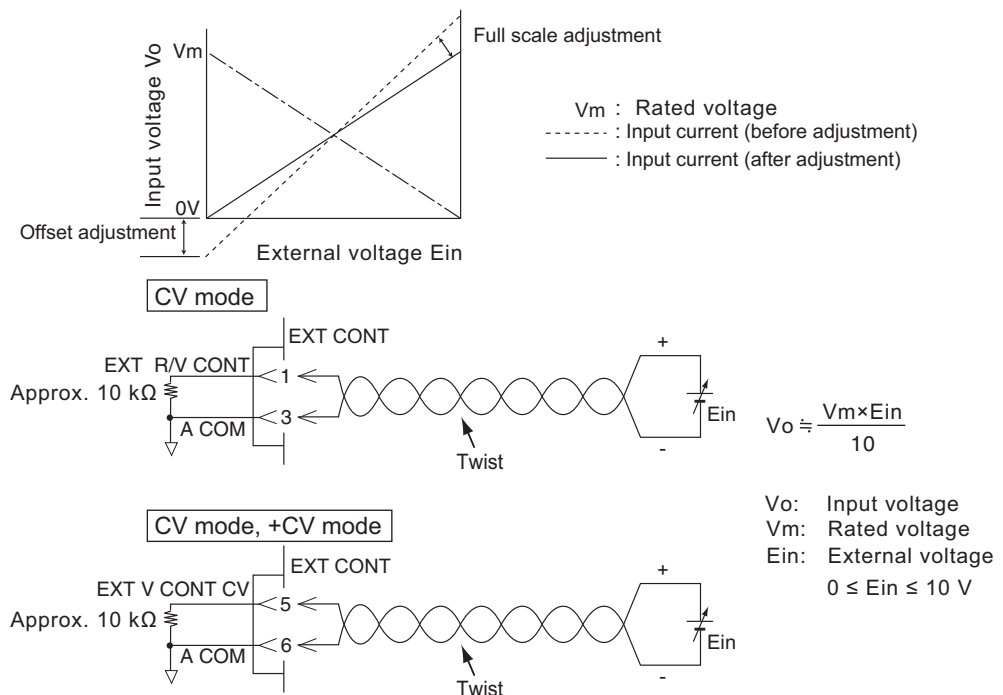

When you are using the +CV modes, be sure to connect the external voltage across pins 5 and 6.

**1** Turn the POWER switch off.



**2 Connect the external voltage across pins 1 and 3 or pins 5 and 6 of the EXT CONT connector.**

If you are controlling the PLZ-4WH in the +CV modes, be sure to connect the external voltage across pins 5 and 6.

**3 Turn the POWER switch on, and make sure that the load is off.****4 Set the operation mode and the current range.**

If you also want to control the current range externally, be sure to set the range to H.

 p. 56

**5 If you have connected the external voltage across pins 1 and 3 of the EXT CONT connector, from the menu, select “2.Configuration” > “3.External” > “Control” > “V.”**

**If you have connected the external voltage across pins 5 and 6 of the EXT CONT connector, from the menu, select “2.Configuration” > “3.External” > “Control CV” > “ON.”**

Doing so enables the external control of CV mode.

Setting Control to V and Control CV to ON from the menu enables the “Control CV” that you have connected to pins 5 and 6 of the EXT CONT connector.

**6 Turn the power switch off and then on again.**

The menu settings are applied.

## Control using an external resistance

You cannot use an external resistance to control the +CV modes.

When you connect an external resistance of 0 Ω to 10 kΩ to the PLZ-4WH, the voltage varies proportionally or inversely to the external resistance.

**Proportional control:** An external resistance of 0 Ω results in a voltage of 0 V. An external resistance of 10 kΩ results in a voltage of 100 % of the specified range.

**Inverse control:** An external resistance of 10 kΩ results in a voltage of 0 V. An external resistance of 0 Ω results in a voltage of 100 % of the specified range.

We recommend that the variable resistors that you connect to the PLZ-4WH be resistant to changes due to temperature and the passage of time. Examples of such resistors include wire wound and metal film resistors and multi-turn potentiometers. Use resistors that have a residual resistance of 50 Ω or less when set to the minimum resistance.

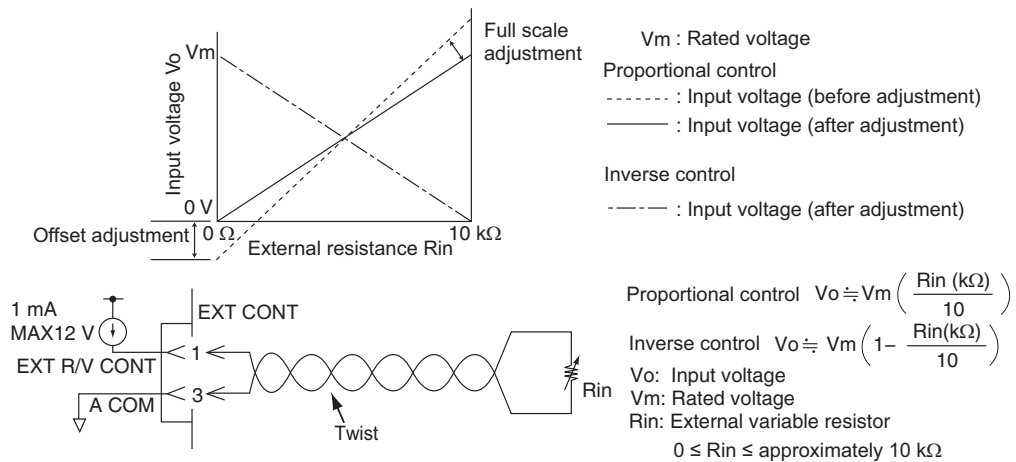

- 1** If you are performing proportional control, set the resistance to the minimum value. If you are performing inverse control, set the resistance to the maximum value.
- 2** Turn the POWER switch off.
- 3** Connect the external variable resistor across pins 1 and 3 of the EXT CONT connector.
- 4** Turn the POWER switch on, and make sure that the load is off.
- 5** Set the operation mode and the current.  
If you also want to control the current range externally, be sure to set the range to H.
- 6** From the menu, select “2.Configuration” > “3.External” > “Control CV” > “OFF.”  
If it is on, turn it off.
- 7** From the menu, select “2.Configuration” > “3.External” > “Control.” If you are performing proportional control, select “R.” If you are performing inverse control, select “Rinv.”  
Doing so enables the external control of CV mode.
- 8** Turn the power switch off and then on again.  
The menu settings are applied.

See p. 56

## Making Sure That the Input Current Changes Proportionally to External Changes

By properly adjusting the OFS (to adjust the current offset) and FSC (to adjust the maximum current) variable resistors on the rear panel, you will be able to control the input current proportionally to the external voltage or resistance. The adjustments are valid for the specified range. If you change the range, readjust the variable resistors.

A load current actually flows during the adjustment, so connect the power supply that you want to test.

Adjustments during external control using pins 5 and 6 of the EXT CONT connector

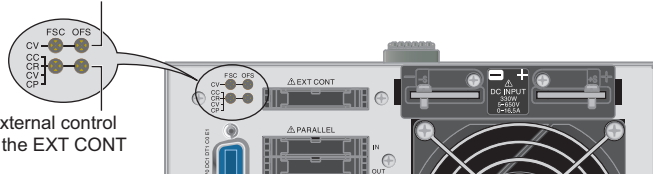

Adjustments during external control using pins 1 and 3 of the EXT CONT connector

### Making sure that the input current changes proportionally to external voltage changes

During CV mode adjustment, use the CV variable resistors (the upper row) when you are using pins 5 and 6 of the EXT CONTROL connector, and use the CC, CR, CV, and CP variable resistors (the lower row) when you are using pins 1 and 3 of the EXT CONTROL connector. In all modes other than CV mode, use the CC, CR, CV, and CP variable resistors (the lower row).

- 1 Turn the load on.**
- 2 Set the external voltage to 0 V.**
- 3 Turn OFS until the measured current on the display is 0 A.**
- 4 Set the external voltage to 10 V.**
- 5 Turn FSC until the measured current on the display is 100 % of the selected range.**
- 6 Turn the load off.**  
This completes the adjustment procedure.

### Making sure that the input current changes proportionally to external resistance changes

Use the CC, CR, CV, and CP variable resistors (the lower row).

- 1 Turn the load on.**
- 2 If you are performing proportional control, set the external resistance to 0  $\Omega$ . If you are performing inverse control, set the external resistance to 10 k $\Omega$ .**
- 3 Turn OFS until the measured current on the display is 0 A.**
- 4 If you are performing proportional control, set the external resistance to 10 k $\Omega$ . If you are performing inverse control, set the external resistance to 0  $\Omega$ .**
- 5 Turn FSC until the measured current on the display is 100 % of the selected range.**
- 6 Turn the load off.**  
This completes the adjustment procedure.

# Turning the Load On and Off through External Control

You can use an external control signal to turn the load on and off, and you can check whether the load is on or off.

## Signal Input for turning the load on and off

To turn the load on and off using an external contact, you need to apply an external signal across pin 7 and 12 of the EXT CONT connector.

When you turn the load off through an external contact, the LOAD key on the front panel becomes invalid.

See p. 56

You can select the logic (LOW or HIGH) to use to turn the load on and off using the menu setup. Select "2. Configuration" > "3. External" > "Load On In." Turn the power switch off and then on again to enable the settings.

If you are not going to control the output using an external contact, set the logic to "HIGH" (the default setting).

Example when the load is turned on by a high level signal from the external contact

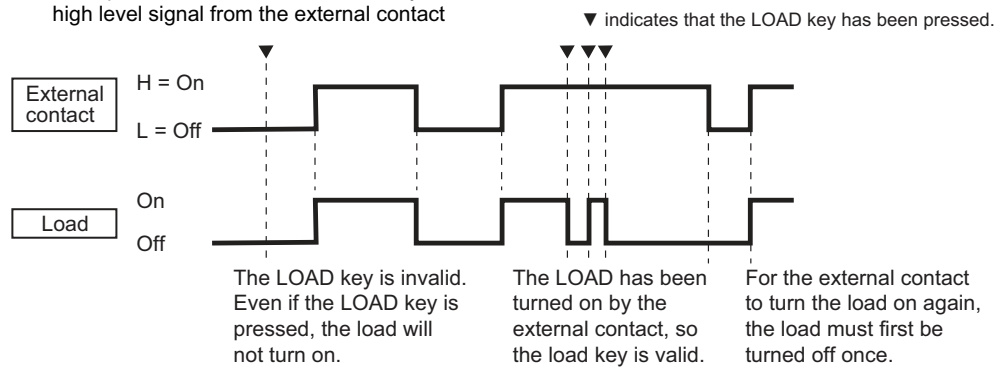

Load On Input	External Contact	
	ON (closed)	OFF (open)
LOW	Load on	Load off
HIGH	Load off	Load on

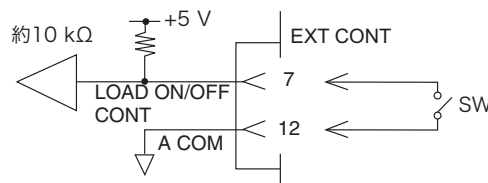

The input pin is pulled up to the internal circuit's +5 V level by a resistor that is approximately 10 kΩ. The maximum allowable voltage is 5 V. The logic threshold levels are CMOS.

## Load-on status signal output

To monitor the status (on or off) of the load externally, monitor the output signal across pins 13 and 17 of the EXT CONT connector.

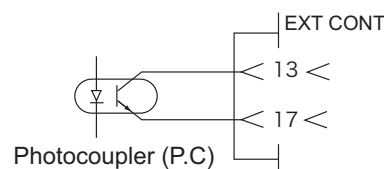

Maximum applied voltage: 30 V  
Maximum current: 8 mA

	Load on	Load off
Photocoupler	On	Off

# Using a Trigger Signal to Control the PLZ-4WH

The application of a trigger signal during sequence execution unpauses the PLZ-4WH. Use a trigger signal when you want to synchronize the PLZ-4WH with an external device.

## Trigger signal input

Apply a voltage signal with a maximum allowable voltage of 5 V and a pulse width of 10  $\mu$ s or more across pins 11 and 12 of the EXT CONT connector.

The trigger signal is output on the rising edge of the pulse signal applied to the trigger input terminal.

The input terminals are pulled down to the internal circuit's A COM level by a resistor that is approximately 100 k $\Omega$ . The maximum allowable voltage is 5 V. The logic threshold levels are CMOS.

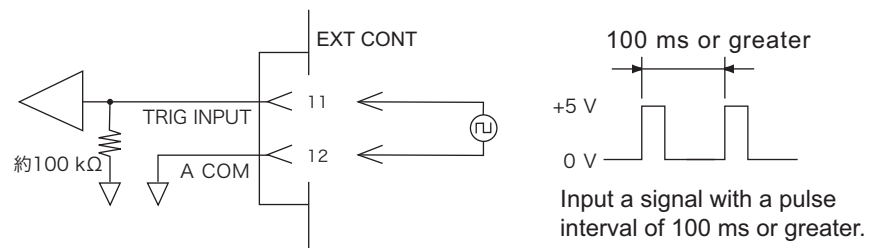

# Controlling the Current Range Externally

You can use an external control signal to control the current range. You can use the range status output to monitor the present state of the range.

You cannot control the voltage range.

Current Range	PLZ			Control Input <sup>1</sup>		Status Output <sup>2</sup>	
	164WH	334WH	1004WH	RANGE CONT 0	RANGE CONT 1	RANGE STATUS 0	RANGE STATUS 1
H	8.25 A	16.5 A	50 A	HIGH	HIGH	OFF	OFF
M	0.825 A	1.65 A	5 A	HIGH	LOW	OFF	ON
L	82.5 mA	165 mA	500 mA	LOW	HIGH	ON	OFF

<sup>1</sup> HIGH: 5 V, LOW: 0 V

<sup>2</sup> OFF: OPEN, ON: SHORT

Set the current range on the panel to the H range.

The current range cannot be changed when the load is turned on. The control signal input received while the load is turned on is ignored.

## Input for switching the range externally

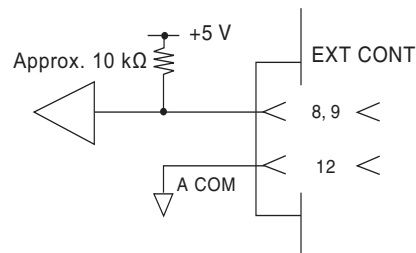

Use pins 8 (RANGE CONT 1) and 9 (RANGE CONT 0) of the EXT CONT connector (use pin 12 as the common).

The signal is 2 bit.

The control terminals are pulled up to the internal circuit's +5 V level by a resistor that is approximately 10 kΩ. The maximum allowable voltage is 5 V. The logic threshold levels are CMOS.

## Range status output

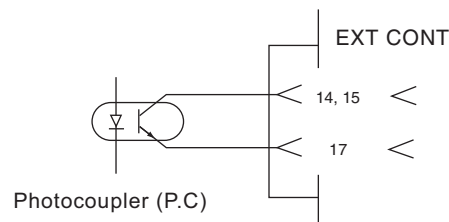

Use pins 14 (RANGE STATUS 1) and 15 (RANGE STATUS 0) of the EXT CONT connector (pin 17 is common).

The signal is 2 bit.

Maximum applied voltage: 30 V  
Maximum current: 8 mA

# Alarm Signal

You can use an external control signal to activate the PLZ-4WH's alarm. You can also use the alarm status output to monitor the alarm status (whether or not it is activated).

## Alarm input

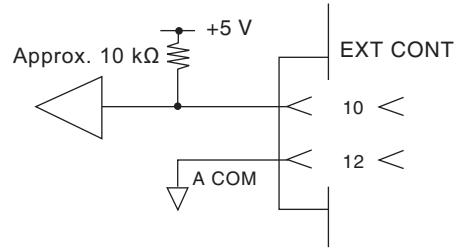

Apply an external signal to pins 10 and 12 of the EXT CONT connector.

The alarm is activated by a low level signal.

The alarm input terminals are pulled up to the internal circuit's +5 V level by a resistor that is approximately 10 k $\Omega$ . The maximum allowable voltage is 5 V. The logic threshold levels are CMOS.

## Alarm status output

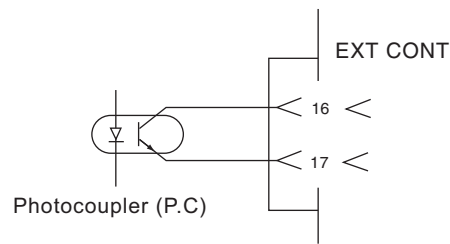

Maximum applied voltage: 30 V  
Maximum current: 8 mA

To monitor the alarm status externally, monitor the output signal across pins 16 and 17 of the EXT CONT connector.

The signal is on when a protection function (OVP, OCP, OPP, OHP, REV, or UVP) is activated or when an external alarm is applied.

# Monitor Signal Output

## Trigger signal output

The trigger signal can be used as a synchronization signal for monitoring the waveform of the switching operation on an oscilloscope. It can also be used to synchronize with an external device during sequence execution.

The trigger signal is output from the TRIG OUT connector (BNC connector) on the PLZ-4WH front panel.

The trigger signal output voltage is approximately 4.5 V. The pulse width is 2  $\mu$ s or more. The output impedance is approximately 1 k $\Omega$ . The TRIG OUT connector is connected to the chassis electric potential. It is isolated from A COM.

The trigger signal output is generated under the following conditions.

- During switching operation.
- When a step in which trigger output has been specified is executed during sequence operation.

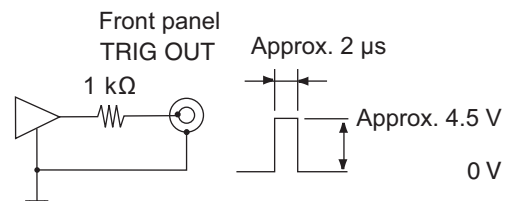

## Current monitor output

The signal is output from the I MON OUT connector on the PLZ-4WH front panel and across pins 2 and 3 (pin 8 is common) of the EXT CONT connector.



To avoid damaging the PLZ-4WH, observe the following precautions. Pin 3 of the EXT CONT connector is connected the negative load input terminal. Make sure that the wire of pin 3 does not touch any of the other pins.

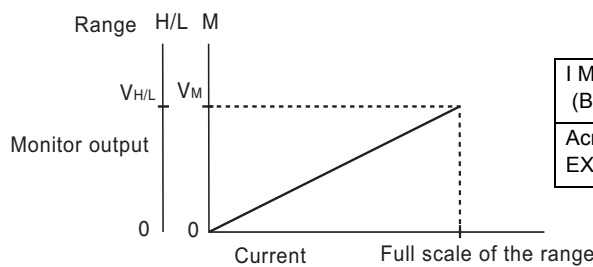

	V <sub>H/L</sub>	V <sub>M</sub>
I MON OUT connector (BNC)	10 V	1 V
Across pins 2 and 3 of the EXT CONT connector	10 V	1 V

### I MON OUT connector (BNC) on the PLZ-4WH front panel

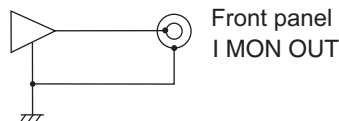

The common is connected to the chassis electric potential. It is isolated from A COM. For current ranges H and L, 1 V corresponds to the full scale current; for current range M, 0.1 V corresponds to the full scale current. The maximum output current is 5 mA.

### Across pins 2 and 3 of the EXT CONT connector

The common is connected to A COM. For current ranges H and L, 10 V corresponds to the full scale current; for current range M, 1 V corresponds to the full scale current. The output impedance is 1 k $\Omega$ .



## Voltage monitor output

The signal is output from the V MON OUT connector on the PLZ-4WH front panel and across pins 4 and 6 (pin 6 is common) of the EXT CONT connector.

### CAUTION

To avoid damaging the product, observe the following precaution. Pin 6 of the EXT CONT connector is connected to the negative load input terminal. Make sure that the wire of pin 6 does not touch any of the other pins.

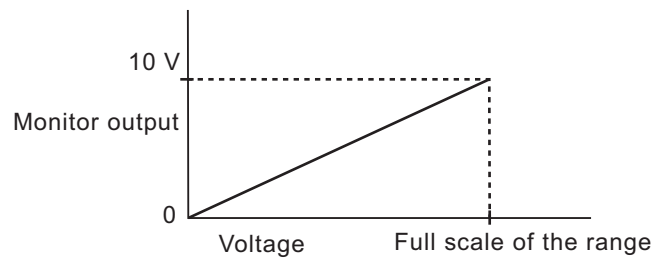

#### ■ V MON OUT connector (BNC) on the PLZ-4WH front panel

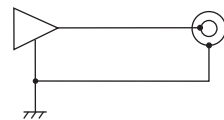

Front panel  
V MON OUT

The common is connected to the chassis electric potential. It is isolated from A COM. For the 650 V and 65 V ranges, 6.5 V corresponds to the full scale voltage. The maximum output current is 5 mA.

#### ■ Across pins 4 and 6 of the EXT CONT connector

The common is connected to A COM. For the 650 V and 65 V ranges, 10 V corresponds to the full scale voltage. The output impedance is 1 k $\Omega$ .

# Parallel Operation

The PLZ-4WH series can be connected to multiple electronic loads in parallel to increase the total current and power capacities. During parallel operation, set one unit as the master unit. The master unit can control all the electronic loads that it is connected to in parallel. The master unit displays the total current and total power for all the electronic loads that it is connected to in parallel.

You can use one of the following two methods to perform parallel operation:

- Parallel operation using the same type of electronic loads  
This method involves connecting a PLZ-4WH that has been set as the master unit to slave PLZ-4WHs in parallel. You can only connect slave units that are the same type of electronic load as the master unit. You can connect up to four slave units (five units including the master unit).
- Parallel operation using boosters  
This method involves connecting a PLZ1004WH that has been set as the master unit to boosters (PLZ2004WHB) in parallel. You can connect up to 4 boosters.  
For details on how to connect and configure units for parallel operation using boosters, see the PLZ2004WHB operation manual.



**CAUTION** To avoid damaging the product, observe the following precaution.

- Do not mix PLZ-4W series and PLZ-4WH series units together in parallel operation.
  - Do not use the load input terminals on the front panel in parallel operation.
- 

 p. 112

Boosters (PLZ2004WHB) can only be connected to the PLZ1004WH.

During parallel operation, the product may not meet the specifications that it has during independent operation. You can improve the accuracy of settings and measurements by calibrating the product during parallel operation.

The current ripple during parallel operation is approximately equal to the value in the specifications for independent operation multiplied by the number of units in parallel operation.

The setting resolution during parallel operation varies depending on the number of units in parallel operation.

When you set the master unit to parallel operation, the settings of each mode, ABC preset memory contents, setup memory contents, and sequence contents are all cleared.

## Connections and Settings during Parallel Operation Using the Same Type of Electronic Loads

See p. 148

Use signal wires and load wires to connect the electronic loads. The optional flat cable (PC01-PLZ-4W or PC02-PLZ-4W) is required to connect signal wires. You can connect up to 4 slave units.



**WARNING** Improper use of load wires may lead to fire. Use load wiring with a diameter that is appropriate for the amount of current being used and with sturdy, incombustible or flame-resistant insulation.



To avoid damaging the product, observe the following precautions.

- When you are performing parallel operation, be sure to use the load input terminal on the rear panel. Do not connect other electronic loads to the load input terminals on the front panel.
- Do not connect the PARALLEL connector's IN and OUT terminals incorrectly.
- Be sure to specify the same number of units as are actually connected. If the wrong number of units is specified or if a slave unit is not turned on during parallel operation, the actual current that flows will differ from the setting and the displayed current.

No. of Slave Units	Maximum Current / Maximum Power		
	PLZ164WH	PLZ334WH	PLZ1004WH
1	16.5 A / 330 W	33 A / 660 W	100 A / 2000 W
2	24.75 A / 495 W	49.5 A / 990 W	150 A / 3000 W
3	33 A / 660 W	66 A / 1320 W	200 A / 4000 W
4	41.25 A / 825 W	82.5 A / 1650 W	250 A / 5000 W

A protective socket is attached to the PARALLEL connector when the PLZ-4WH is in the factory default state. Store this protective socket in a safe place so that it can be used during independent operation. If it is damaged or lost, contact your Kikusui agent or distributor.

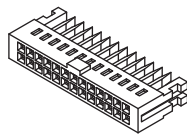

Protective socket for J1  
[84-49-0071]



**WARNING** To avoid electric shock, observe the following precaution. The PARALLEL connector contains pins that have the same potential as the output terminal. When the PARALLEL connector is not in use, be sure to attach the protective socket that comes with the PLZ-4WH.

Be sure to turn off the PLZ-4WH's power switch before you attach or remove sockets and cables.

When you remove a socket or cable, first release the lock lever on each side of the socket or cable, and then pull from the socket or cable.

When considering the load wires that you will connect to the PLZ-4WH, take into account the current that you will be using, and use load wires that are as short as possible and have sufficient thickness. We recommend that you use busbars.

Improper use of load wires may lead to operational instability. Wire the load wires so that they are as far away from the flat cables as possible.

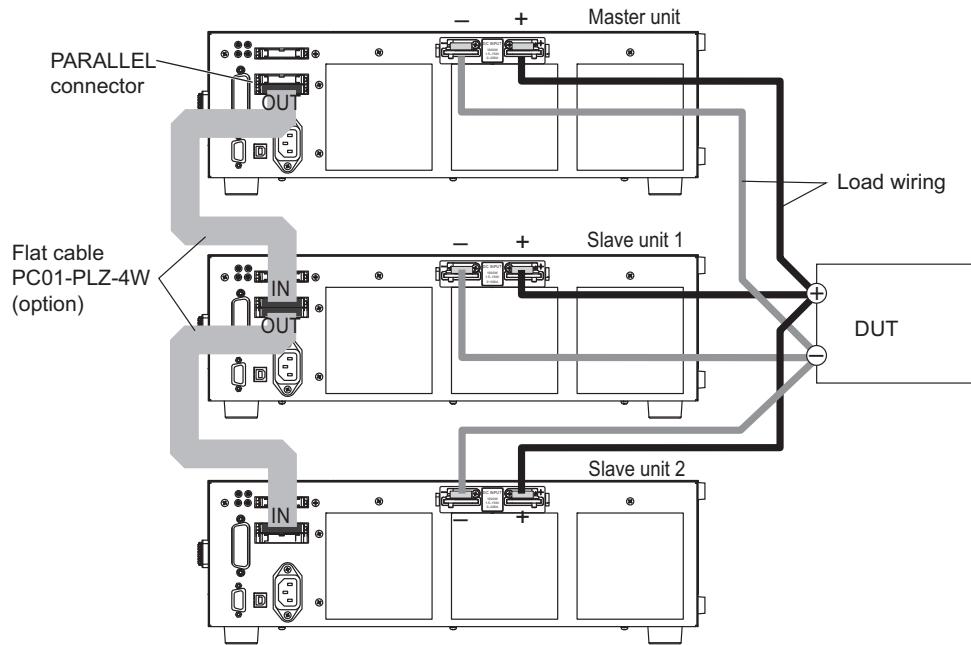

Example of connecting two slave units

- 1** Check that all electronic loads that you will connect in parallel operation are turned off.
- 2** Connect the load input terminals of each electronic load to each other.  
Refer to the connection diagram shown above to connect the load input terminals of multiple electronic loads that are the same type to each other in parallel.
- 3** Use the optional flat cable to connect the master unit's OUT parallel connector to the first slave unit's IN parallel connector.  
Be extremely careful when you connect the units to each other. Connecting them incorrectly may damage them.
- 4** Use the optional flat cable to connect the first slave unit's OUT parallel connector to the second slave unit's IN parallel connector. Continue connecting all the remaining slave units in the same manner.  
This completes the connection procedure for parallel operation using the same type of electronic loads. Next, configure the settings on the master and slave units.
- 5** Turn all the electronic loads on.
- 6** On the master unit, from the menu, select "2.Configuration" > "1.Master/Slave" > "Operation" > "MASTER."
- 7** On the master unit, from the menu, select "2.Configuration" > "1.Master/Slave" > "Parallel," and then specify the total number of units that are connected in parallel.  
Specify the total number of units, including the master unit. Be sure that you specify the same number of units that are actually connected.
- 8** On a slave unit, from the menu, select "2.Configuration" > "1.Master/Slave" > "Operation" > "SLAVE."  
Make this setting on all slave units.
- 9** Turn all the POWER switches off.  
The menu settings are applied. This completes the configuring of the master unit and slave unit settings.

# Performing Parallel Operation

See p. 56

During parallel operation, the slew rate and response speed settings on the master unit are used. The maximum slew rate is the maximum value on the master unit.

If a unit on which the response speed has been set to 1/1 is set as the master unit for parallel operation, its response speed is changed to 1/2 to ensure operational stability. You can use the menu settings to return the response speed to 1/1.

If large voltage drops occur because of increased wiring inductance or if oscillations occur due to instability of the product caused by current phase lag, reduce the response speed to ensure stable operation.

## Turning the power on and off

### ■ Turning the power on

- 1 Turn the **POWER** switches of all slave units on.
- 2 Turn the master unit's **POWER** switch on.

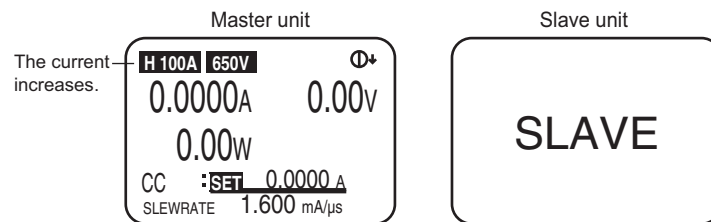

### ■ Turning the power off

There is no set order for turning the power off. Turn all the electronic loads off.

## Alarms during parallel operation

If an alarm occurs during parallel operation, an error message is displayed, and all electronic loads turn their load off. If the alarm occurred on a slave unit, "ALARM EXTERNAL" is displayed on the master unit. Clear the alarm on the master unit.

## Ending parallel operation

---

To end parallel operation and return to independent operation, turn all the units off, and then remove the flat cables.

To return a slave unit to independent operation, from the menu, select “2.Configuration” > “1.Master/Slave” > “Operation” > “MASTER,” and then restart the unit.

To return a master unit that was connected to boosters to independent operation, from the menu, select “2.Configuration” > “1.Master/Slave” > “Booster” > “-,” and then restart the unit.



To avoid damaging the product, observe the following precautions. Do not operate the PLZ-4WH alone with the flat cable connected.

---



# 6

---

## Maintenance

This chapter describes the maintenance procedures including cleaning, inspection, and calibration.

# Inspection

To purchase accessories or options, contact your Kikusui agent or distributor.

## Cleaning the dust filter

The dust filter is installed on the inside of the louver on the front panel. Periodically clean the filter to prevent clogging.

### ⚠ CAUTION

- A clogged filter hinders the cooling of the inside of the PLZ-4WH, can cause malfunctions, and can shorten the PLZ-4WH's service life.
- When the PLZ-4WH is in operation, air is sucked through the dust filter to cool the inside of the device.  
If moisture is present in the dust filter, the temperature or humidity inside the PLZ-4WH increases and may cause malfunctions.

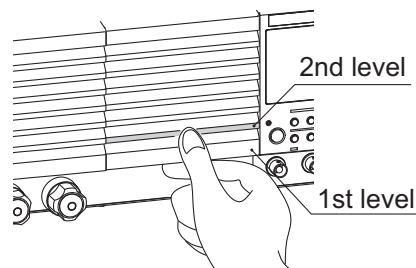

**1 Use both hands to grab the four edges of the louver.**

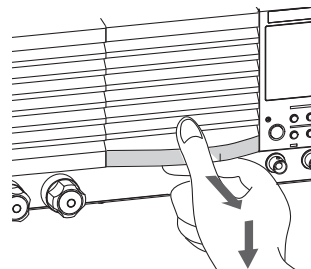

**2 While pulling the bottom slat towards you, slide the top of the louver down, and remove the louver from the panel.**

If the louver is difficult to remove, press down on the top row to make the louver easier to remove.

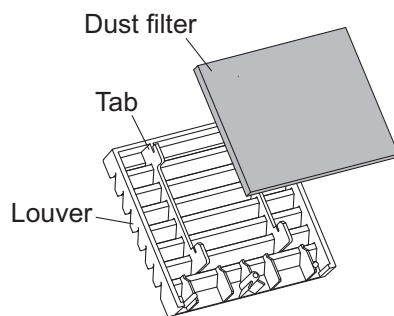

**3 Remove the dust filter from the inside of the louver and clean it.**

Use a vacuum cleaner to dispose of the dust and foreign particles that are attached to the dust filter. If the filter is extremely dirty, clean it using a water-diluted neutral detergent and dry it completely.

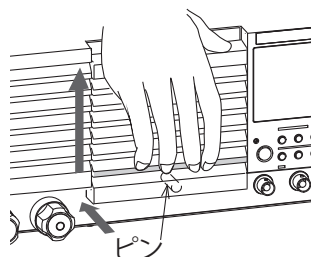

**4 Attach the dust filter to the louver.**

Firmly attach the dust filter so that the louver's tabs protrude out of the top of the dust filter.

**5 Attach the louver so that its tabs enter the slots in the panel. While pushing on the second slat from the bottom of the louver, slide the louver up to attach it to the PLZ-4WH.**



## Internal inspection

The PLZ-4WH's electrolytic capacitor, fan motor, and backup-memory battery will wear out over time.

The exact timing varies depending on how the PLZ-4WH is used, but we recommend that you have the PLZ-4WH overhauled after about 10,000 hours of operation. An overhaul includes internal inspection and cleaning. To have the PLZ-4WH overhauled, please contact a Kikusui distributor or agent.

## Backup battery replacement

The PLZ-4WH has a battery inside. The battery's service life differs depending on the environment that the PLZ-4WH is used in, but three years after it is purchased is a rough estimate for the battery's service life. If the panel settings are not retained after the power switch is turned off and on, the battery has worn out. For information about replacing the battery, contact your Kikusui agent or distributor.

# Calibration

The PLZ-4WH is calibrated properly when it is shipped, but we recommend that you calibrate it regularly to keep it operating at top performance.

## What gets calibrated?

The current and voltage values are calibrated.

The current values are calibrated for each of the three current ranges (L, M, and H).

The voltage values are calibrated for each of the two voltage ranges (65 V and 650 V).

The offset and gain values for all the ranges indicated above are calibrated.

Offset value: 10 % of the full scale value

Gain value: 100 % of the full scale value

During operation, the relationship between the current setting and the actual current and the relationship between the voltage setting and the actual voltage are linear. Therefore, a straight line is defined by the calibrated offset and gain values. During operation, the relationships between the current and voltage settings and the actual current and voltage values are determined by the calibrated straight line.

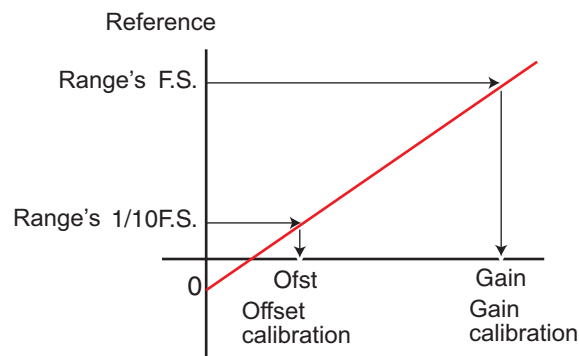

## Calibrated items

The following eight items are calibrated for the three voltage ranges and the two current ranges.

1. The offset value of the internal reference voltage for current settings.
2. The gain value of the internal reference voltage for current settings.
3. The offset value of the internal reference voltage for voltage settings.
4. The gain value of the internal reference voltage for voltage settings.
5. The offset value for measured values.
6. The gain value for measured values.
7. The offset value of the internal reference voltage for the protection function settings.
8. The gain value of the internal reference voltage for the protection function settings.

The offset values of the internal reference voltages for the settings and of the measured values are calibrated simultaneously. The same is true for the gain values.

When you press ENTER or NEXT (SHIFT+►) in the gain calibration screen, the calibration data is written to the internal memory.

### ■ Calibration numbers

The numbers that appear in the calibration screen are the calibration numbers.

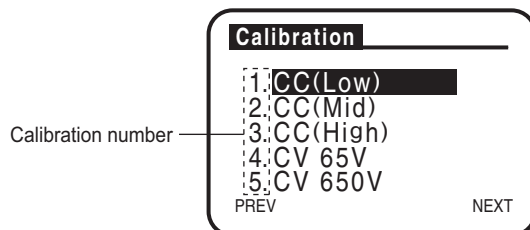

### Alarm

If an alarm occurs during calibration, the PLZ-4WH produces an alarm sound, and the load turns off. After you remove the cause of the alarm and press ENTER, the alarm sound stops, and the PLZ-4WH returns to the Calibration screen.

Start calibration again from the calibration number at which the alarm occurred.

## Preparation

Before you calibrate the PLZ-4WH, leave it on for 30 minutes or more to warm it up. Warming up reduces measurement error caused by initial drift. Keep the ambient temperature at  $23 \pm 5^\circ\text{C}$ .

Equipment used

Name	Required Accuracy	Required Rating		
		PLZ164WH	PLZ334WH	PLZ1004WH
DC voltmeter	Within 0.02 %	Measurement voltage range: 0 V to 700 V		
Shunt resistor <sup>1</sup>	0.1 %	For 0.1 A For 1 A For 50 A	For 0.2 A For 2 A For 20 A	For 0.5 A For 5 A For 50 A
Regulated DC power supply (constant-voltage power supply)	—	Voltage: 5 V Current: 8.25 A	Voltage: 5 V Current: 16.5 A	Voltage: 5 V Current: 50 A
Regulated DC power supply (constant current power supply)	—	Voltage: 700 V Current: 50 mA		

<sup>1</sup>. In place of a shunt resistor, you can use an ammeter.

Connect the equipment as shown below. Select an appropriate shunt resistor according to type of calibration that you are performing.

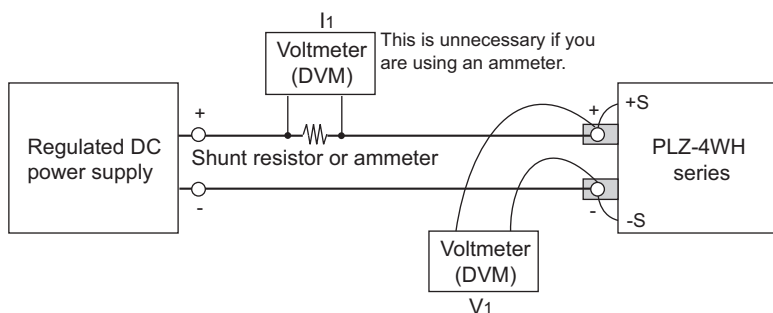

# CC Mode Calibration (Calibration numbers 1, 2, and 3)

Perform calibration on the Low, Mid, and then High range. For each item, start calibration at step A. Be sure to calibrate both offset and gain.

Current Range	Percentage of the Full Scale (%)	Calibrated Items					
		Internal reference voltage for current settings.		Measured Values		Internal Reference Voltage for the Protection Function Settings	
		Offset	Gain	Offset	Gain	Offset	Gain
Low	10	Step A	–	Step A	–	Step B	–
	100	–	Step C	–	Step C	–	Step D
Mid	10	Step A	–	Step A	–	Step B	–
	100	–	Step C	–	Step C	–	Step D
High	10	Step A	–	Step A	–	Step B	–
	100	–	Step C	–	Step C	–	Step D

## ■ CC mode settings

The current settings for each model are listed below.

Calibration Number and Item		Output Setting of the Power Supply	Current to Be Matched				
			PLZ164WH	PLZ334WH	PLZ1004WH		
1	CC (Low)	Offset	Voltage: 5 V	8.25 mA±8.25 µA	16.5 mA±16.5 µA	50 mA±50 µA	
		Gain		82.5 mA±82.5 µA	165 mA±165 µA	0.5 A±0.5 mA	
2	CC (Mid)	Offset		82.5 mA±82.5 µA	165 mA±165 µA	0.5 A±0.5 mA	
		Gain		825 mA±825 µA	1.65 A±1.65 mA	5 A±5 mA	
3	CC (High)	Offset		Current: Rated current of the load device	825 mA±825 µA	1.65 A±1.65 mA	5 A±5 mA
		Gain			8.25 A±8.25 mA	16.5 A±16.5 mA	50 A±50 mA



When calibrating multiple PLZ-4WHs of the same model operating in parallel operation, multiply the current setting by the number of units.

Example: Three PLZ334WHs in parallel operation using CC (Mid) gain

$$(1.65 \text{ A} \pm 1.65 \text{ mA}) \times 3 = 4.95 \text{ A} \pm 4.95 \text{ mA}$$

When calibrating a setup that includes a PLZ2004WHB, multiply the rated power [kW]/1 [kW] to the current setting for the PLZ1004WH.

Example: One PLZ1004WH (1 kW) and two PLZ2004WHBs (2kW) using CC (High) gain

Because the rated power is 5 kW, the current setting is (50 A±50 mA) ×5=250 A±250 mA

Use shunt resistors and a regulated DC power supply whose rated currents are higher than the maximum current that flows during calibration.

## Calibrating the low range

### ■ Step A: Calibrate the offset values of the internal reference voltage for current settings and of the measured values.

- 1** Connect a shunt resistor or ammeter that matches the value corresponding to 10 % of the full scale low range value.
- 2** Press MENU (SHIFT+SET/VSET).  
The menu screen appears.
- 3** Use ▼ to select “3. Calibration,” and then press ENTER.
- 4** Use ▼ and ▲ to select “1. CC(Low).”

**5** Connect a constant-voltage power supply to the load input terminals, and apply 5 V. Set the power supply current to approximately +2 % to 5 % of the load device's rated current.

**6** Press ENTER.

The load turns on automatically, and the offset calibration (CC (Low) Offset Adjustment) screen appears.

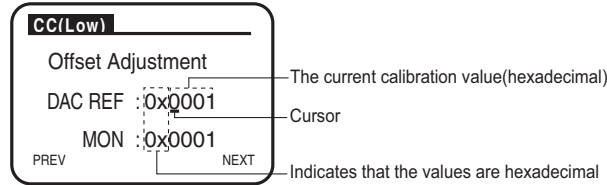

**7** Press ◀ or ▶ to set the cursor position of DAC REF, and then turn the rotary knob so that the current flowing through the shunt resistor is within ±0.1 % of the value corresponding to 10 % of the full scale value (see the table of CC mode settings).

The measured value offset MON is set automatically.

■ **Step B: Calibrate the offset value for the internal reference voltage for the protection functions.**

**8** Press ENTER.

The offset calibration screen (CC (Low) Limit Offs Adjust) appears.

**9** Press ◀ or ▶ to set the cursor position of DAC LIM, and then turn the rotary knob so that the current flowing through the shunt resistor is within ±0.1 % of the value corresponding to 10 % of the full scale value (see the table of CC mode settings).

**10** Press ENTER.

The load turns off automatically.

■ **Step C: Calibrate the gain values of the internal reference voltage for current settings and of the measured values.**

**11** Connect a shunt resistor that matches the value corresponding to 100 % of the maximum low range value.

**12** Press ENTER.

The load turns on automatically, and the gain calibration screen (CC (Low) Gain Adjustment) appears.

**13** Press ◀ or ▶ to set the cursor position of DAC REF, and then turn the rotary knob so that the current flowing through the shunt resistor is within ±0.1 % of the value corresponding to 100 % of the full scale value (see the table of CC mode settings).

The measured value gain MON is set automatically.

■ **Step D: Calibrate the gain value for the internal reference voltage for the protection function settings.**

**14** Press ENTER.

The gain calibration screen (CC (Low) Limit Gain Adjust) appears.

**15** Press ◀ or ▶ to set the cursor position of DAC LIM, and then turn the rotary knob so that the current flowing through the shunt resistor is

within  $\pm 0.1\%$  of the value corresponding to 100 % of the full scale value (see the table of CC mode settings).

**16** Press ENTER.

The load turns off automatically. The calibration of the low range current values is complete.

**Calibrating the mid range**

Calibrate the Mid range in the same way that you calibrated the Low range. In step 4 , select “2. CC(Mid).”

**Calibrating the high range**

Calibrate the High range in the same way that you calibrated the Low range. In step 4 , select “3. CC(High).”

The calibration of CC mode is complete after you calibrate the High range.

# CV Mode Calibration (Calibration numbers 4 and 5)

Perform calibration on the Low range and then on the High range. For each item, start calibration at step E. The shunt resistor will not be used, but you can leave it connected.

Voltage Range	Percentage of the Full Scale (%)	Calibrated Items					
		Internal Reference Voltage for Voltage Settings		Measured Values		Internal Reference Voltage for the Protection Function Settings	
		Offset	Gain	Offset	Gain	Offset	Gain
Low	10	Step E	–	Step E	–	Step F	–
	100	–	Step G	–	Step G	–	Step H
High	10	Step E	–	Step E	–	Step F	–
	100	–	Step G	–	Step G	–	Step H

**■ CV mode settings**

The current settings for each model are listed below.

Calibration Number and Item			Output Setting of the Power Supply	Voltage to Be Matched
4	CV 65V	Offset	Voltage: 66 V Current: 0.05 A	6.5 V $\pm$ 3.25 mV
		Gain		65 V $\pm$ 32.5 mV
5	CV650V	Offset	Voltage: 660 V Current: 0.05 A	65 V $\pm$ 32.5 mV
		Gain		650 V $\pm$ 325 mV

**Calibrating the low range**

Monitor the input voltage using an external voltmeter.

■ **Step E: Calibrate the offset values of the internal reference voltage for voltage settings and the measured values.**

- 1 Use ▼ and ▲ to select “4. CV 65V.”
- 2 Connect a CC power supply to the load input terminals, and supply 0.05 A. Set the power supply voltage to 66 V or greater.
- 3 Press ENTER.  
The load turns on automatically, and the offset calibration (CV 65V Offset Adjustment) screen appears.

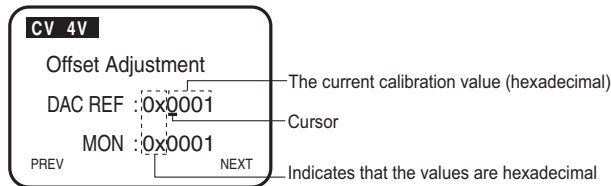

- 4 Press ◀ or ▶ to set the cursor position of DAC REF, and then turn the rotary knob so that the input voltage is within  $\pm 0.05\%$  of the value corresponding to 10 % of the full scale value (see the table of CV mode settings).  
The measured value offset MON is set automatically.

■ **Step F: Calibrate the offset value for the internal reference voltage for the protection functions.**

- 5 Press ENTER.  
The offset calibration screen (CV 65 V Limit Offs Adjust) appears.
- 6 Press ◀ or ▶ to set the cursor position of DAC LIM, and then turn the rotary knob so that the input voltage is within  $\pm 0.05\%$  of the value corresponding to 10 % of the full scale value (see the table of CV mode settings).
- 7 Press ENTER.  
The load turns off automatically.

■ **Step G: Calibrate the gain values of the internal reference voltage for voltage settings and of the measured values.**

- 8 Press ENTER.  
The load turns on automatically, and the gain calibration (CV 65V Gain Adjustment) screen appears.
- 9 Press ◀ or ▶ to set the cursor position of DAC REF, and then turn the rotary knob so that the input voltage is within  $\pm 0.05\%$  of the value corresponding to 100 % of the full scale value (see the table of CV mode settings).  
The measured value gain MON is set automatically.

■ **Step H: Calibrate the gain value for the internal reference voltage for the protection function settings.**

- 10 Press ENTER.  
The gain calibration screen (CV 65 V Limit Gain Adjust) appears.

**11** Press ◀ or ▶ to set the cursor position of DAC REF, and then turn the rotary knob so that the input voltage is within  $\pm 0.05$  % of the value corresponding to 100 % of the full scale value (see the table of CV mode settings).

**12** Press ENTER.

The load turns off automatically.

The calibration of the low range voltage values is complete.

### Calibrating the high range

Calibrate the High range in the same way that you calibrated the Low range. In step 4 , select "5. CV 650 V." Set the voltage of the power supply to 660 V or more.

The calibration of CV mode is complete after you calibrate the High range.

## Ending Calibration

**1** Press PREV (SHIFT+◀).

The screen that was displayed before the calibration screen appears.

**2** Press MENU (SHIFT+SET/VSET).

The screen that was displayed before the menu appears.

---

**NOTE**

When you press ENTER or NEXT (SHIFT+▶) in the gain calibration screen, the calibration data is written to the internal memory.

If you only want to check the calibration data, be sure to press PREV (SHIFT+◀) or MENU (SHIFT+SET/VSET) to exit the gain calibration screen.

---



# Troubleshooting

This section describes remedies for malfunctions encountered during the use of the PLZ-4WH. Representative symptoms and their possible check items are indicated. Look for the item that corresponds to your case. In some cases, the problem can be solved quite easily.

If your problem does not correspond to any of the listed items, we recommend that you initialize the PLZ-4WH to its factory default settings. If you carry out the corrective action but the situation does not improve, contact your Kikusui distributor or agent.

## ■ Symptom 1: Nothing appears on the display when the POWER switch is turned on.

Check Item		Possible Cause	Remedy
Location and Status of the Object	Check Result		
Is rated voltage applied for the input power supply (AC)?	No	Broken power cord Bad connection at the AC INPUT connector on the rear panel	Check that the power cord is not broken and that the connection at the AC INPUT connector is secure.
	Yes	Malfunction	Remove the power cord plug from the outlet. Immediately stop the use of the instrument and request repairs.

## ■ Symptom 2: The display is dark.

Check Item		Possible Cause	Remedy
Location and Status of the Object	Check Result		
Is rated voltage applied for the input power supply (AC)?	No	Low supply voltage	Use the PLZ-4WH in the input supply voltage range.
	Yes	Bad contrast adjustment	Adjust the contrast. See: "Turning the Power On" on page 15

## ■ Symptom 3: Keys do not work.

Check Item		Possible Cause	Remedy
Location and Status of the Object	Check Result		
Is key lock mode enabled?	Yes	Key lock is enabled.	Release the key lock. See: "Locking the Keys" on page 43
	No	Malfunction	Immediately stop the use of the instrument and request repairs.

## ■ Symptom 4: Input current is unstable or oscillates.

Check Item		Possible Cause	Remedy
Location and Status of the Object	Check Result		
Is rated voltage applied for the input power supply (AC)?	No	Low supply voltage	Use the PLZ-4WH in the input supply voltage range.
	Yes	Malfunction	Immediately stop the use of the instrument and request repairs.
Is the ALARM illuminated?	Yes	An internal or external error occurred on the PLZ-4WH.	Check the alarm type and carry out the appropriate remedy. See: "Protection Functions" on page 51
Is there a large loop in the load wire?	Yes	→	Twist the wires. See: "Load wiring" on page 17
The load wire is long.	Long	→	Change the response (transient response) using menu setup.

■ Symptom 5:ALARM is activated.

Check Item		Possible Cause	Remedy
Location and Status of the Object	Check Result		
Is the fan stopped?	Yes	Overheat protection tripped.	Immediately stop the use of the instrument and request repairs.
Is the air intake or outlet obstructed?	Yes	Overheat protection tripped. Clogged dust filter	Allow at least 20 cm between the air outlet and the wall. In addition, do not place objects within 20 cm. Clean the dust filter.
Is OCP tripped?	Yes	The OCP setting is small.	Reset the OCP value in the setup screen. See: "Protection Functions" on page 51
Is OPP tripped?	Yes	The OPP setting is small.	Reset the OPP value in the setup screen. See: "Protection Functions" on page 51

■ Symptom 6:The load cannot be turned on.

Check Item		Possible Cause	Remedy
Location and Status of the Object	Check Result		
A sequence is in operation	Yes	→	Wait for the sequence operation to finish. Abort the sequence by pressing STOP.
	No	The load on/off logic (Load ON IN) is set to low.	In the menu, select "Configuration" and set "Load ON INput" to "HIGH." See: "Menu" on page 56
Are you using an external signal to turn the load off?	Yes	→	The load key will be valid after you use an external signal to turn the load on. See: "Turning the Load On and Off through External Control" on page 96



# 7

---

## Specifications

This chapter contains the specifications and gives the dimensions of the PLZ-4WH.

Unless specified otherwise, the specifications are for the following settings and conditions.

- The warm-up time is 30 minutes (with current flowing).
- TYP: These are typical values that are representative of situations where the PLZ-4WH operates in an environment with an ambient temperature of 23 °C. These values do not guarantee the performance of the PLZ-4WH.
- After PLZ-4WH has been warmed up, it must be calibrated correctly in a 23 °C ± 5 °C environment according to the procedures given in the operation manual.
- % of set: Denotes a percentage of the input voltage, input current, or input power setting.
- % of f.s: Denotes a percentage of the rated input voltage, rated input current, or rated input power.
- % of reading: Denotes a percentage of the input voltage, input current, or input power reading.

## Ratings

Model	PLZ164WH	PLZ334WH	PLZ1004WH
Operating voltage (DC) <sup>1</sup>	5 V to 650 V		
Current	8.25 A	16.5 A	50 A
Power	165 W	330 W	1000 W
Input resistance when the load is off	Approx. 2.21 MΩ <sup>2</sup>		

<sup>1</sup> The minimum operating voltage at which current begins to flow through the PLZ-4WH is approximately 50 mV. At the load input terminals on the rear panel.

<sup>2</sup> Approx. 2.21/(the number of units) MΩ during parallel operation of units of the same model.

## Constant current (CC) mode

Model	PLZ164WH	PLZ334WH	PLZ1004WH	
Operating range	H range	0 A to 8.25 A	0 A to 16.5 A	0 A to 50 A
	M range	0 A to 825 mA	0 A to 1.65 A	0 A to 5 A
	L range	0 A to 82.5 mA	0 A to 165 mA	0 A to 500 mA
Setting range	H range	0 A to 8.6625 A	0 A to 17.325 A	0 A to 52.5 A
	M range	0 A to 866.25 mA	0 A to 1.7325 A	0 A to 5.25 A
	L range	0 A to 86.625 mA	0 A to 173.25 mA	0 A to 525 mA
Resolution	H range	300 μA	1 mA	2 mA
	M range	30 μA	100 μA	200 μA
	L range	3 μA	10 μA	20 μA
Accuracy of setting	L range, M range	±(0.2 % of set + 0.1 % of f.s <sup>1</sup> )		
	L range, 300μA or more	±(0.2 % of set + 0.1 % of f.s)		
	L range, less than 300μA	±(0.2 % of set + 0.1 % of f.s) + V <sub>in</sub> <sup>2</sup> / 2.21 MΩ		
	Parallel Operation	±(0.2 % of set + 1.1 % of f.s <sup>1</sup> )		
Input voltage variation <sup>3</sup>	H range, M range	20 mA		
	L range	2 mA		
Ripple	rms <sup>4</sup>	2 mA	4 mA	12 mA
	p-p <sup>5</sup>	20 mA	40 mA	120 mA

<sup>1</sup> The full scale of the range. However, for the M range, it is the full scale of the H range.

<sup>2</sup> V<sub>in</sub>: The voltage at the load input terminals on the rear panel or sensing terminals

<sup>3</sup> When the input voltage is changed from 5 V to 650 V at a current equal to the rated power/650 V.

<sup>4</sup> Measurement frequency bandwidth: 10 Hz to 1 MHz

<sup>5</sup> Measurement frequency bandwidth: 10 Hz to 20 MHz

## Constant resistance (CR) mode

Model		PLZ164WH	PLZ334WH	PLZ1004WH
Operating range <sup>1</sup>	H range	1.65 S to 30 $\mu$ S (606.06 m $\Omega$ to 33.333 k $\Omega$ )	3.3 S to 60 $\mu$ S (303.03 m $\Omega$ to 16.666 k $\Omega$ )	10 S to 200 $\mu$ S (100 m $\Omega$ to 5 k $\Omega$ )
	M range	165 mS to 3 $\mu$ S (6.06 $\Omega$ to 333.333 k $\Omega$ )	330 mS to 6 $\mu$ S (3.03 m $\Omega$ to 166.666 k $\Omega$ )	1 S to 20 $\mu$ S (1 $\Omega$ to 49.999 k $\Omega$ )
	L range	16.5 mS to 0.3 $\mu$ S (60.606 $\Omega$ to 3.333 M $\Omega$ )	33 mS to 0.6 $\mu$ S (30.303 $\Omega$ to 1.666 M $\Omega$ )	100 mS to 2 $\mu$ S (10 $\Omega$ to 500 k $\Omega$ )
Setting range	H range	1.7325 S to 0 S (577.2 m $\Omega$ to OPEN)	3.465 S to 0 S (288.6 m $\Omega$ to OPEN)	10.5 S to 0 S (95.23 m $\Omega$ to OPEN)
	M range	173.25 mS to 0 S (5.772 $\Omega$ to OPEN)	346.5 mS to 0 S (2.886 $\Omega$ to OPEN)	1.05 S to 0 S (952.3 m $\Omega$ to OPEN)
	L range	17.325 mS to 0 S (57.72 $\Omega$ to OPEN)	34.65 mS to 0 S (28.86 $\Omega$ to OPEN)	105 mS to 0 S (9.523 $\Omega$ to OPEN)
Resolution	H range	30 $\mu$ S	60 $\mu$ S	200 $\mu$ S
	M range	3 $\mu$ S	6 $\mu$ S	20 $\mu$ S
	L range	0.3 $\mu$ S	0.6 $\mu$ S	2 $\mu$ S
Accuracy of setting <sup>2</sup>	H range, M range	$\pm(0.5 \% \text{ of set}^3 + 0.5 \% \text{ of f.s.}^4)$		
	L range	$\pm(0.5 \% \text{ of set}^3 + 0.5 \% \text{ of f.s.}) + \text{Vin}^5 / 2.21 \text{ M}\Omega$		
	Parallel Operation (TYP)	$\pm(1.2 \% \text{ of set}^3 + 1.1 \% \text{ of f.s.}^4)$		

<sup>1</sup> Conductance [S] = Input current [A]/input voltage [V] = 1/resistance [ $\Omega$ ]

<sup>2</sup> Converted value based on the input current at the sensing point.

<sup>3</sup> set = Vin/Rset

<sup>4</sup> The full scale of the range. However, for the M range, it is the full scale of the H range.

<sup>5</sup> Vin: The voltage at the load input terminals on the rear panel or sensing terminals

## Constant voltage (CV) mode

Model		PLZ164WH	PLZ334WH	PLZ1004WH
Operating range	H range	5 V to 650 V		
	L range	5 V to 65 V		
Setting range	H range	0 V to 682.5 V		
	L range	0 V to 68.25 V		
Resolution	H range	20 mV		
	L range	2 mV		
Accuracy of setting <sup>1</sup>		$\pm(0.2 \% \text{ of set} + 0.2 \% \text{ of f.s.})$		
	Parallel Operation (TYP)	$\pm(0.2 \% \text{ of set} + 0.2 \% \text{ of f.s.})$		
Input current variation <sup>2</sup>		65 mV		

<sup>1</sup> At the sensing point during remote sensing when the input voltage is within the operating range.

<sup>2</sup> At an input voltage of 0.3 V when the current changes from 10 % to 100 % of the rating (during remote sensing)

## Constant (CP) power mode

Model		PLZ164WH	PLZ334WH	PLZ1004WH
Operating range	H range	16.5 W to 165 W	33 W to 330 W	100 W to 1000 W
	M range	1.65 W to 16.5 W	3.3 W to 33 W	10 W to 100 W
	L range	0.165 W to 1.65 W	0.33 W to 3.3 W	1 W to 10 W
Setting range	H range	0 W to 173.25 W	0 W to 346.5 W	0 W to 1050 W
	M range	0 W to 17.325 W	0 W to 34.65 W	0 W to 105 W
	L range	0 W to 1.7325 W	0 W to 3.465 W	0 W to 10.5 W
Resolution	H range	10 mW	20 mW	100 mW
	M range	1 mW	2 mW	10 mW
	L range	0.1 mW	0.2 mW	1 mW
Accuracy of setting	H range, M range	$\pm(2.5 \% \text{ of f.s}^1)$		
	L range, 0.25 W or more	$\pm(3 \% \text{ of f.s})$		
	L range, Less than 0.25 W	$\pm(3 \% \text{ of f.s} + V_{in}^2 / 2.21 \text{ M}\Omega)$		
	Parallel Operation (TYP)	$\pm(5 \% \text{ of f.s} + V_{in}^2 / 2.21 \text{ M}\Omega)$ at 23 °C $\pm$ 5 °C		

<sup>1</sup> The full scale of the range. However, for the M range, it is the full scale of the H range.

<sup>2</sup> Vin: The voltage at the load input terminals on the rear panel or sensing terminals

## Measurements

### Voltmeter

Model		PLZ164WH	PLZ334WH	PLZ1004WH
Display	H range	0.00 V to 650.00 V		
	L range	0.000 V to 65.000 V		
Accuracy	Parallel Operation (TYP)	$\pm(0.1 \% \text{ of reading} + 0.1 \% \text{ of f.s})$		

### Ammeter

Model		PLZ164WH	PLZ334WH	PLZ1004WH
Display	H range, M range	0.0000 A to 8.2500 A	0.000 A to 16.500 A	0.00 A to 50.000 A
	L range	0.000 mA to 82.500 mA	0.00 mA to 165.00 mA	0.00 mA to 500.00 mA
Accuracy	Parallel Operation (TYP)	$\pm(0.2 \% \text{ of reading} + 0.3 \% \text{ of f.s})$		
	Parallel Operation (TYP)	$\pm(1.2 \% \text{ of reading} + 0.3 \% \text{ of f.s}^1)$		

<sup>1</sup> The full scale of the range. However, for the M range, it is the full scale of the H range.

### Wattmeter

Model		PLZ164WH	PLZ334WH	PLZ1004WH
Display <sup>1</sup>	H range, M range	0.00 W to 165.00 W	0.00 W to 330.00 W	0.0 W to 1000.0 W
	L range, except CP mode	0.000 W to 53.625 W	0.00 W to 107.25 W	0.00 W to 325.00 W
	L range, CP mode	0.0000 W to 1.6500 W	0.0000 W to 3.3000 W	0.0000 W to 10.000 W

<sup>1</sup> Displays the product of the voltmeter reading and ammeter reading.

## Switching mode

Model		PLZ164WH	PLZ334WH	PLZ1004WH
Operation modes		CC and CR		
Duty cycle		5 % to 95 % <sup>1</sup> in 0.1 % steps		
Frequency range		1 Hz to 4 kHz		
Frequency resolution	1 Hz to 10 Hz	0.1 Hz		
	10 Hz to 100 Hz	1 Hz		
	100 Hz to 1 kHz	10 Hz		
	1 kHz to 4 kHz	100 Hz		
Frequency accuracy of setting		±(0.5 % of set )		

<sup>1</sup> The minimum time width is 50  $\mu$ s. Between 1 kHz and 4 kHz, the maximum duty cycle is limited by the minimum time width.

## Slew rate

Model		PLZ164WH	PLZ334WH	PLZ1004WH
Setting range <sup>1</sup>	H range	0.132 mA/ $\mu$ s to 132 mA/ $\mu$ s	0.264 mA/ $\mu$ s to 264 mA/ $\mu$ s	0.8 mA/ $\mu$ s to 0.8 A/ $\mu$ s
	M range	13.2 $\mu$ A/ $\mu$ s to 13.2 mA/ $\mu$ s	26.4 $\mu$ A/ $\mu$ s to 26.4 mA/ $\mu$ s	80 $\mu$ A/ $\mu$ s to 80 mA/ $\mu$ s
	L range	1.32 $\mu$ A/ $\mu$ s to 1.32 mA/ $\mu$ s	2.64 $\mu$ A/ $\mu$ s to 2.64 mA/ $\mu$ s	8 $\mu$ A/ $\mu$ s to 8 mA/ $\mu$ s
Resolution (the setting ranges are indicated in parentheses)	H range	50 $\mu$ A/ $\mu$ s (13.2 mA/ $\mu$ s to 132 mA/ $\mu$ s)	100 $\mu$ A/ $\mu$ s (26.4 mA/ $\mu$ s to 264 mA/ $\mu$ s)	300 $\mu$ A/ $\mu$ s (0.08 A/ $\mu$ s to 0.8 A/ $\mu$ s)
		5 $\mu$ A/ $\mu$ s (1.32 mA/ $\mu$ s to 13.2 mA/ $\mu$ s)	10 $\mu$ A/ $\mu$ s (2.64 mA/ $\mu$ s to 26.4 mA/ $\mu$ s)	30 $\mu$ A/ $\mu$ s (8 mA/ $\mu$ s to 80 mA/ $\mu$ s)
		0.5 $\mu$ A/ $\mu$ s (0.132 mA/ $\mu$ s to 1.32 mA/ $\mu$ s)	1 $\mu$ A/ $\mu$ s (0.264 mA/ $\mu$ s to 2.64 mA/ $\mu$ s)	3 $\mu$ A/ $\mu$ s (0.8 mA/ $\mu$ s to 8 mA/ $\mu$ s)
	M range	5 $\mu$ A/ $\mu$ s (1.32 mA/ $\mu$ s to 13.2 mA/ $\mu$ s)	10 $\mu$ A/ $\mu$ s (2.64 mA/ $\mu$ s to 26.4 mA/ $\mu$ s)	30 $\mu$ A/ $\mu$ s (8 mA/ $\mu$ s to 80 mA/ $\mu$ s)
		0.5 $\mu$ A/ $\mu$ s (0.132 mA/ $\mu$ s to 1.32 mA/ $\mu$ s)	1 $\mu$ A/ $\mu$ s (0.264 mA/ $\mu$ s to 2.64 mA/ $\mu$ s)	3 $\mu$ A/ $\mu$ s (0.8 mA/ $\mu$ s to 8 mA/ $\mu$ s)
		50 nA/ $\mu$ s (13.2 $\mu$ A/ $\mu$ s to 132 $\mu$ A/ $\mu$ s)	100 nA/ $\mu$ s (26.4 $\mu$ A/ $\mu$ s to 264 $\mu$ A/ $\mu$ s)	0.3 $\mu$ A/ $\mu$ s (80 $\mu$ A/ $\mu$ s to 800 $\mu$ A/ $\mu$ s)
	L range	0.5 $\mu$ A/ $\mu$ s (0.132 mA/ $\mu$ s to 1.32 mA/ $\mu$ s)	1 $\mu$ A/ $\mu$ s (0.264 mA/ $\mu$ s to 2.64 mA/ $\mu$ s)	3 $\mu$ A/ $\mu$ s (0.8 mA/ $\mu$ s to 8 mA/ $\mu$ s)
		50 $\mu$ A/ $\mu$ s (13.2 $\mu$ A/ $\mu$ s to 132 $\mu$ A/ $\mu$ s)	100 nA/ $\mu$ s (26.4 $\mu$ A/ $\mu$ s to 264 $\mu$ A/ $\mu$ s)	0.3 $\mu$ A/ $\mu$ s (80 $\mu$ A/ $\mu$ s to 800 $\mu$ A/ $\mu$ s)
		5 nA/ $\mu$ s (1.32 $\mu$ A/ $\mu$ s to 13.2 $\mu$ A/ $\mu$ s)	10 nA/ $\mu$ s (2.64 $\mu$ A/ $\mu$ s to 26.4 $\mu$ A/ $\mu$ s)	30 nA/ $\mu$ s (8 $\mu$ A/ $\mu$ s to 80 $\mu$ A/ $\mu$ s)
Accuracy of setting <sup>2</sup>		±(10 % of set + 25 $\mu$ s)		

<sup>1</sup> Can only be set in constant current mode. In constant resistance mode, the maximum slew rate of each range is 1/10.

<sup>2</sup> The time it takes to shift from 10 % to 90 % when the current is varied from 2 % to 100 % (20 % to 100 % in the M range) of the rated current

## Soft start

Model	PLZ164WH	PLZ334WH	PLZ1004WH
Operation mode	CC		
Selectable times <sup>1</sup>	1 ms, 2 ms, 5 ms, 10 ms, 20 ms, 50 ms, 100 ms, 200 ms		
Time accuracy	±(30 % of set +100 µs)		

<sup>1</sup> The time it takes to shift from 10 % to 90 % of the rated current

## Response speed

Model	PLZ164WH	PLZ334WH	PLZ1004WH
CC mode, CR mode	1/1, 1/2, 1/5, 1/10		
CV mode	100, 10, 1, 1/10, 1/100		

## Remote sensing

Model	PLZ164WH	PLZ334WH	PLZ1004WH
Voltage that can be compensated	2 V for a single line		

## Protection function

Model	PLZ164WH	PLZ334WH	PLZ1004WH
Overvoltage protection (OVP)	Turns off the load when 110 % of the range's maximum voltage is detected.		
Overcurrent protection (OCP)	Can be set to 110 % of each range's maximum current or the values given below.		
	0.01 A to 9.07 A	0.01 A to 18.15 A	0.01 A to 55 A
	The action can be set to load off or limit.		
Overpower protection (OPP)	Can be set to 110 % of each range's maximum power or 0.1 % to 110 % of the rated power.		
	The action can be set to load off or limit.		
Overheat protection (OHP)	Turns off the load when the heat sink temperature reaches 90 °C		
Undervoltage protection (UVP)	Turns off the load when the specified value is detected		
	Can be set to a value from 5 V to 650 V or OFF		
Reverse-connection protection (REV)	Implemented through a fuse and a diode Turns off the load when an alarm occurs		



## Sequence function

Model		PLZ164WH	PLZ334WH	PLZ1004WH
Normal sequence	Operation modes	CC, CR, CV, and CP		
	Maximum number of steps	256		
	Step execution time	1 ms to 999 h 59 min		
	Time resolution (setting range)	1 ms for 1 ms to 1 min 100 ms for 1 min to 1 h 1 s for 1 h to 10 h 10 s for 10 h to 100 h 1 min for 100 h to 999 h 59 min		
Fast sequence	Operation modes	CC and CR		
	Maximum number of steps	1024		
	Step execution time	100 $\mu$ s to 100 ms		
	Time resolution	100 $\mu$ s		

## Other functions

Model	PLZ164WH	PLZ334WH	PLZ1004WH
Elapsed time display	Measures the time from load on to load off. Can be turned on and off.		
	Measures from 1 s up to 999 h 59 min 59 s		
Auto load-off timer	Automatically turns off the load after a specified time elapses		
	Can be set to off or a time within the range of 1 s to 999 h 59 min 59 s		

## Common specifications

### Analog External Control (EXT CONT connector)

Load on/off control input	Turn on the load with a high (or low) CMOS level signal Logic level switchable. The internal circuit is pulled up to 5 V by a 10 kΩ resistor.
Range switch input	Switch ranges L, M, and H using a 2-bit signal
Trigger input	Clear the sequence operation pause with a high CMOS level signal whose duration is 10 μs or longer The internal circuit is pulled down to common by a 100 kΩ resistor.
External alarm input	Activate the alarm with a low CMOS level signal The internal circuit is pulled up to 5 V by a 10 kΩ resistor.
Alarm status output	On when OVP, OCP, OPP, OHP, or REV is activated or when an external alarm input is applied (open collector output from a photocoupler)
Load on status output	On when the load is on (open collector output from a photocoupler)
Range status output	Outputs range L, M, or H using a 2-bit signal (open collector output from a photocoupler).
Short signal output	Relay contact output (30 Vdc/1 A).
External voltage control (CC, CR, CP, and CV mode)	External input voltages in the range of 0 V to 10 V correspond to 0 % to 100 % of the rated current (CC mode), rated power (CP mode), and rated voltage (CV mode). External input voltages in the range of 0 V to 10 V correspond to the range of resistances from the maximum resistance to the minimum resistance (CR mode).
External resistance control (CC, CR, CP, and CV mode)	External resistances in the range of 0 Ω to 10 kΩ correspond to 0 % to 100 % or 100 % to 0 % of the rated current (CC mode), rated power (CP mode), or rated voltage (CV mode). External resistances in the range of 0 Ω to 10 kΩ correspond to the range of resistances from the maximum resistance to the minimum resistance or from the minimum resistance to the maximum resistance (CR mode).
Current monitor output	10 V for f.s (H or L range), 1 V for f.s (M range)
Voltage monitor output	For each range, 10 V for f.s

### Front-Panel BNC Terminal

TRIG OUT	Transmits pulses during sequence operation and switching operation. Output impedance: 1 kΩ, Output voltage: approx. 4.5 V, Pulse width: 2 μs
Current monitor output	10 V for f.s (H or L range), 1 V for f.s (M range) Output current: up to 5 mA
Voltage monitor output	For each range, 6.5 V for f.s, Output current: up to 5 mA

### Communication Functions

GPIB	IEEE std. 488.1-1987 SH1, AH1, T6, L4, SR1, RL1, PP0, DC1, DT1, C0, E1
	Supports the SCPI and IEEE std. 488.2-1992 command set Sets panel functions except for the function of the power switch and reads measured values
RS232C	D-SUB 9-pin connector (conforms to EIA-232-D)
	Supports the SCPI and IEEE std. 488.2-1992 command set Sets panel functions except for the function of the power switch and reads measured values Baud rate: 2400, 4800, 9600, 19200 bps Data length: 8 bits, Stop bits: 1/2 bits, Parity bit: None Flow control: Xon/Xoff
USB	Conforms to the USB 2.0 specifications and the USBTMC-USB488 device class specifications Standard Type B socket
	Sets panel functions except for the function of the power switch and reads measured values Communication speed 12 Mbps (Full speed)

## General specifications

Model		PLZ164WH	PLZ334WH	PLZ1004WH
Input voltage range		100 Vac to 240 Vac (90 Vac to 250 Vac), single phase, continuous		
Input frequency range		47 Hz to 63 Hz		
Power consumption		80 VAm <sub>ax</sub>	90 VAm <sub>ax</sub>	160 VAm <sub>ax</sub>
Inrush current <sup>1</sup>		140 Am <sub>ax</sub>		
Protective conductor current <sup>2</sup>		600 μA (100 Vac at 50 Hz; TYP)		
Operating temperature range		0 °C to 40 °C (32 °F to 104 °F)		
Operating humidity range		20 %rh to 85%rh (no condensation)		
Storage temperature range		-20 °C to 70 °C (-4 °F to 158 °F)		
Storage humidity range		90 %rh or less (no condensation)		
Isolation voltage		±750 Vdc		
Insulation resistance	Primary to input terminal	1 000 Vdc, 30 MΩ or more (ambient humidity of 70 %rh or less)		
	Primary to chassis	1 000 Vdc, 30 MΩ or more (ambient humidity of 70 %rh or less)		
	Secondary to chassis	1 000 Vdc, 30 MΩ or more (ambient humidity of 70 %rh or less)		
Withstand voltage	Primary to input terminal	No abnormalities at 1500 Vac for 1 minute		
	Primary to chassis	No abnormalities at 1500 Vac for 1 minute		
	Secondary to chassis	No abnormalities at 1 000 Vdc for 1 minute		
Dimensions (mm)		See the outline drawing.		
Weight		Approx. 7 kg (15.4 lb.)	Approx. 8 kg (17.6 lb.)	Approx. 16 kg (35.3 lb.)
Battery backup		Backs up setup information		
Accessories	Power cord	1 pc. (with plug, length: 2.4 m)		
	Load input terminal cover	1 pc.		
	Lockplate for the load input terminal cover	2 sets		
	Set of screws for the load input terminal	2 sets		
	CD-R	1 pc.		
	Operation Manual	Setup Guide: 1 pc., Quick Reference(English & Japanese): Each 1 pc.		
Safety <sup>3</sup>		Complies with the requirements of the following directive and standards. Low Voltage Directive 2014/35/EU <sup>4</sup> EN 61010-1 (Class I <sup>5</sup> , Pollution degree 2 <sup>6</sup> )		
Electromagnetic compatibility (EMC) <sup>3, 4</sup>		Complies with the requirements of the following directive and standards. EMC Directive 2014/30/EU EN 61326-1 (Class A <sup>7</sup> ), EN55011 (Class A <sup>7</sup> , Group 1 <sup>8</sup> ) EN 61000-3-2 EN 61000-3-3  Applicable under the Following Condition The maximum length of all cabling and wiring connected to the PLZ-4WH must be less than 3 m.		

<sup>1</sup> Approx. 70 A when receiving an input of 100 Vac

<sup>2</sup> If the input voltage or input frequency is different, the following equation can be used to calculate the value.

$$\text{Protective conductor current} = \frac{\text{Input voltage [V]}}{100 \text{ [V]}} \times \frac{\text{Input frequency [Hz]}}{50 \text{ [Hz]}} \times 600 \text{ [\mu A]}$$

<sup>3</sup> Does not apply to specially ordered or modified PLZ-4WHs.

<sup>4</sup> Limited to products that have the CE mark on their panels. Not be in compliance with EMC limits unless the ferrite core is attached on the cable for connection of J1 connector.

<sup>5</sup> This is a Class I equipment. Be sure to ground this product's protective conductor terminal. The safety of this product is only guaranteed when the product is properly grounded.

<sup>6</sup> Pollution is addition of foreign matter (solid, liquid or gaseous) that may produce a reduction of dielectric strength or surface resistivity. Pollution Degree 2 assumes that only non-conductive pollution will occur except for an occasional temporary conductivity caused by condensation.

<sup>7</sup> This is a Class A equipment. This product is intended for use in an industrial environment. This product may cause interference if used in residential areas. Such use must be avoided unless the user takes special measures to reduce electromagnetic emissions to prevent interference to the reception of radio and television broadcasts.

<sup>8</sup> This is a Group 1 equipment. This product does not generate and/or use intentionally radio-frequency energy, in the form of electromagnetic radiation, inductive and/or capacitive coupling, for the treatment of material or inspection/analysis purpose.

# Dimensions

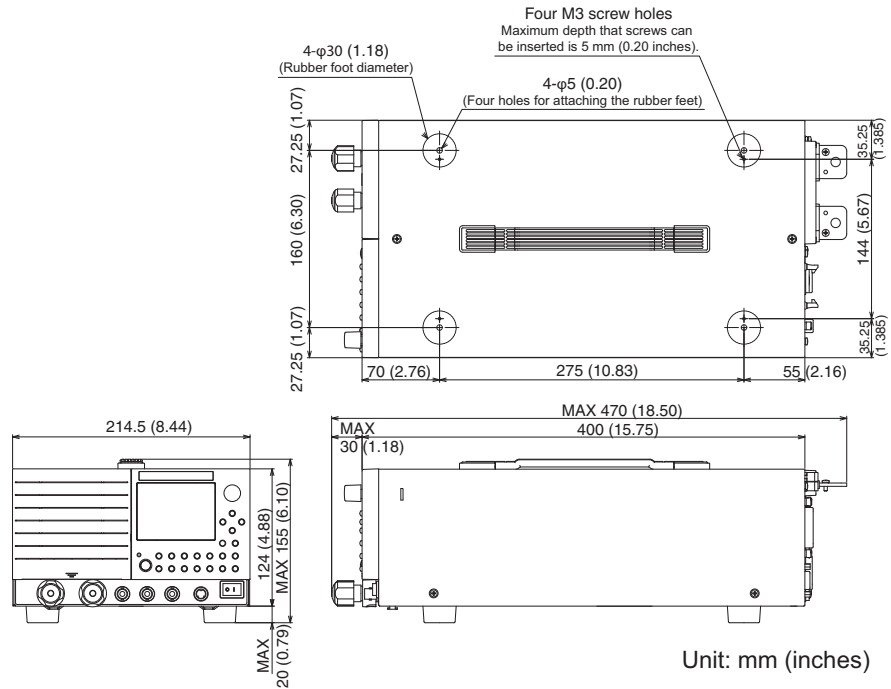

Outline drawing (PLZ164WH and PLZ334WH)

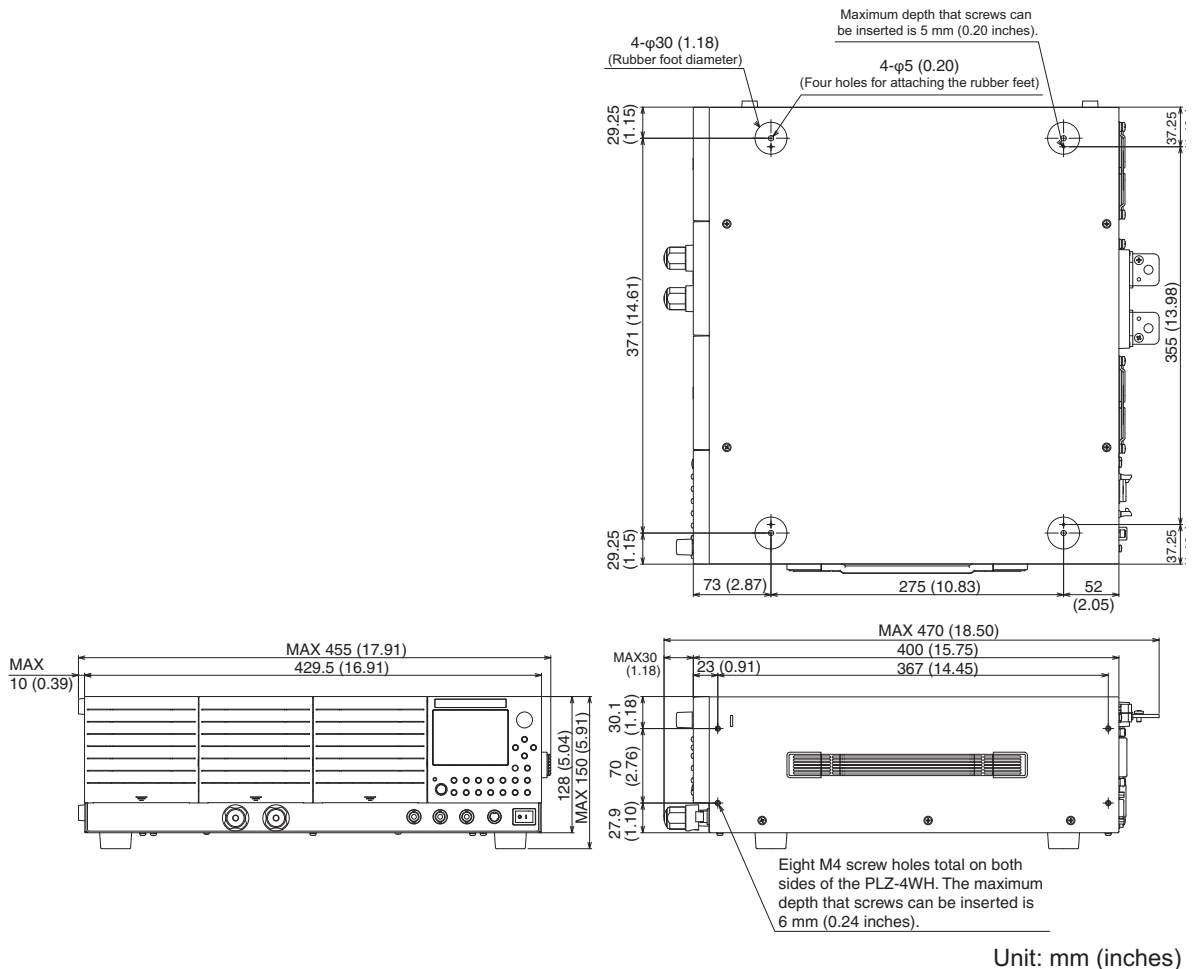

Outline drawing (PLZ1004WH)



# Appendix

---

- A Operating Area
- B Sequence Program Creation Table
- C Options

# A Operating Area

As shown in the figure, the PLZ-4WH can be used within the area enclosed by L1, the constant-voltage line defined by the rated voltage; L2, the constant-power line defined by the rated power; L3, the constant-current line defined by the rated current; and L4, the constant-voltage line defined by the minimum operating voltage (the enclosed area is where specifications are guaranteed). The specifications are guaranteed for input voltages greater than or equal to 5 V, but the PLZ-4WH can be used at lower voltages (actual operating area) if the current is reduced. However, the specifications are not guaranteed.

The minimum operating voltage at which current begins to flow through the PLZ-4WH is approximately 0.5 V. If the input voltage is gradually increased from 0 V, no current will flow until this minimum operating voltage is exceeded. If the input voltage exceeds the minimum operating voltage and a current greater than or equal to 1 % of the range rating (greater than or equal to 1 % of the H range when the PLZ-4WH is set using the M range) starts flowing, the current can keep flowing even when the voltage is reduced down.

For the operating areas of each model, see "Operating areas of each model".

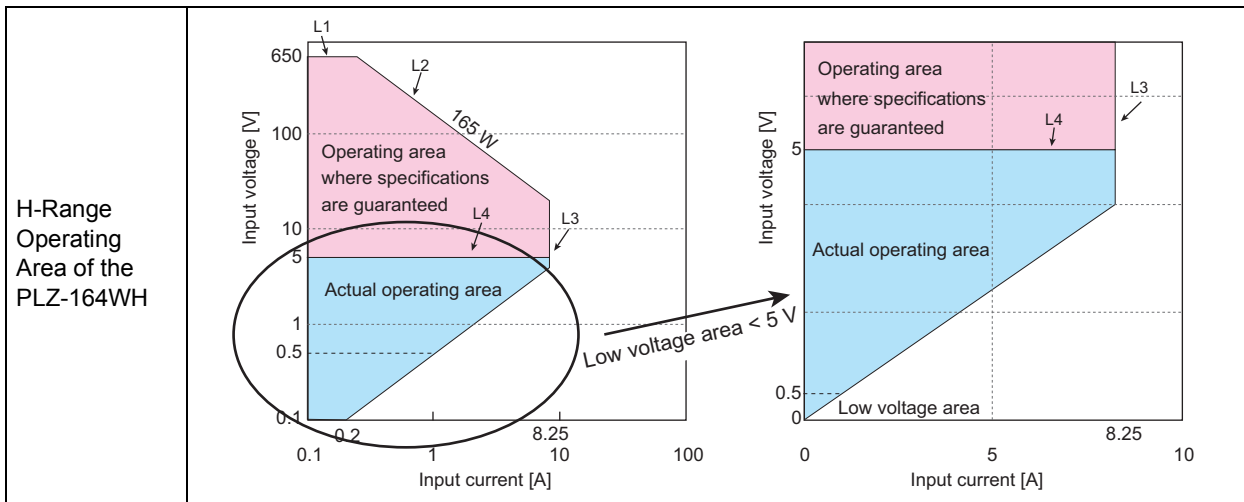

## Basic operation modes

The following six operation modes are available on the PLZ-4WH.

- Constant current mode (CC mode)
- Constant resistance mode (CR mode)
- Constant power mode (CP mode)
- Constant voltage mode (CV mode)
- Constant current and constant voltage mode (CC+CV mode)
- Constant resistance and constant voltage mode (CR+CV mode)

## How constant current (CC) mode works

In constant current (CC) mode, the PLZ-4WH maintains the same current even if the voltage changes.

### Constant current mode operation

When the PLZ-4WH is used in constant current (CC) mode, it operates as a constant-current load as shown in the figure below. The PLZ-4WH sinks the specified current ( $I$ ) regardless of the output voltage ( $V_1$ ) of the constant-voltage power supply.

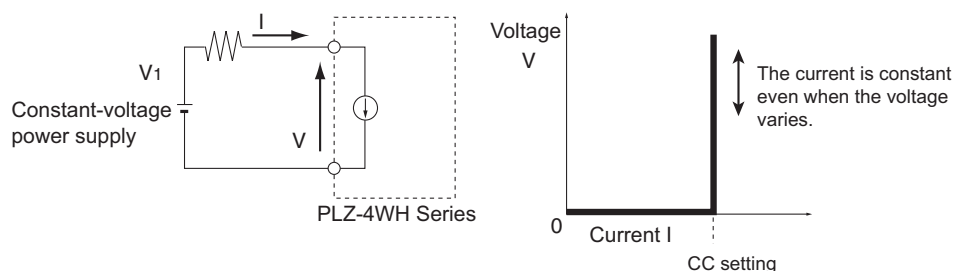

### Transition of the operating point: overpower protection (OPP)

In this example, we will assume that the PLZ-4WH is being used in constant current (CC) mode to test the load characteristic of a constant-voltage power supply.

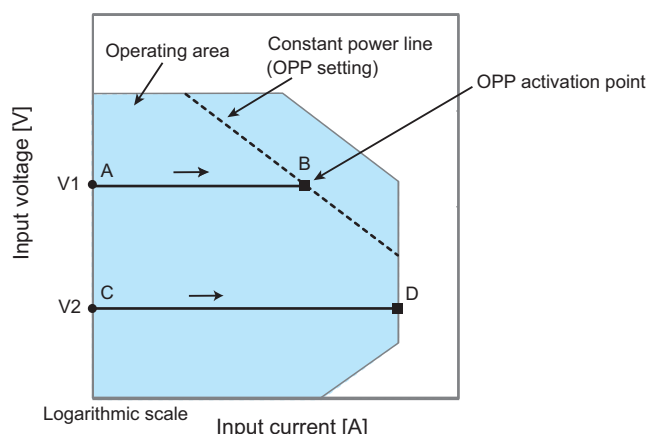

#### ■ Operation on segment AB

If the voltage of the constant-voltage power supply is set to  $V_1$  and the input current (load current) of the PLZ-4WH is increased, the operating point moves along segment AB.

When point B is reached, overpower protection (OPP) is activated. At this point, one of two types of operations occurs, depending on the protection action setting for OPP.

If the protection action is set to LOAD OFF, the load turns off.

If the protection action is set to LIMIT, the PLZ-4WH sinks current as a constant-power load at point B. Even if you attempt to increase the input current, the current will not increase beyond point B. If you decrease the input current, overpower protection (OPP) is cleared. The PLZ-4WH returns to constant current (CC) mode, and the operating point moves along segment AB.

Point B	LOAD OFF	The load is turned off (no current flows). The PLZ-4WH stops operating as a load.
	LIMIT	The PLZ-4WH switches out of constant current (CC) mode. Overpower protection (OPP) continues, and the PLZ-4WH operates as a constant-power load.

■ Operation on segment CD

If the voltage of the constant-voltage power supply is set to V2 and the input current (load current) of the PLZ-4WH is increased, the operating point moves along segment CD. Point D is the maximum current in the range being used.

## How constant resistance (CR) mode works

In constant resistance (CR) mode, the PLZ-4WH sinks current in proportion to the voltage variation.

### Constant resistance mode operation

When the PLZ-4WH is used in constant resistance (CR) mode, it operates as a resistive load as shown in the figure below. When the voltage (V1) of the constant-voltage power supply varies, the PLZ-4WH sinks current to maintain  $I = V/R$ , with the specified resistance R fixed. This mode cannot be used with an AC circuit.

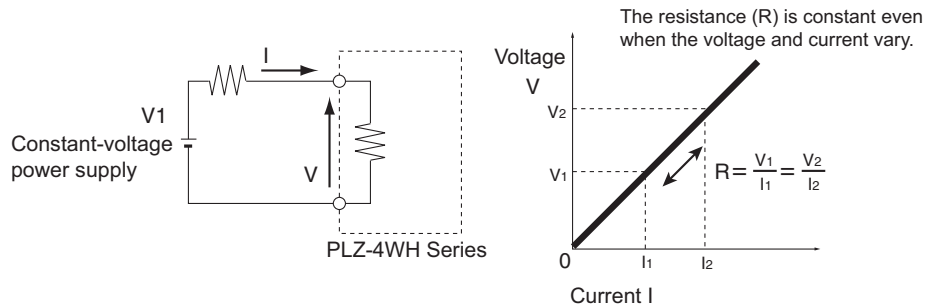

### Transition of the operating point: overpower protection (OPP)

In this example, we will assume that the PLZ-4WH is being used in constant resistance (CR) mode to test the load characteristic of a constant-voltage power supply.

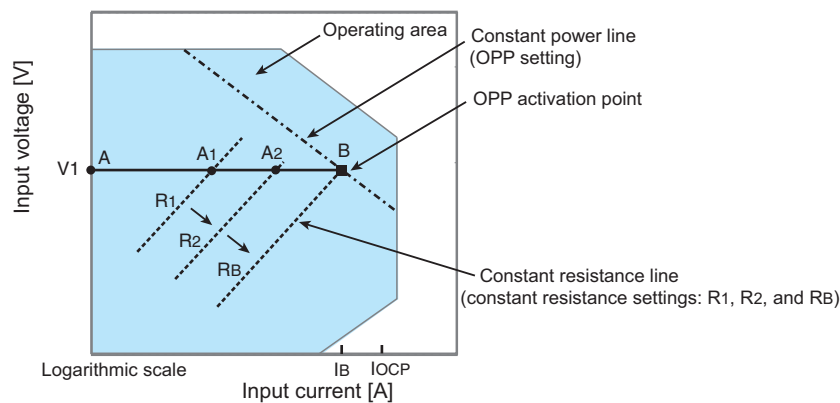

If the overcurrent protection (OCP) setting IOCP is greater than the current value IB at point B, when the PLZ-4WH resistance is decreased ( $R1 \rightarrow R2 \rightarrow RB$ ) so that the input current (load current) increases, with the voltage of the constant-voltage power supply at V1, the operating point moves along segment AB ( $A1 \rightarrow A2 \rightarrow B$ ). When point B is reached, overpower protection (OPP) is activated.

At this point, one of two types of operations occurs, depending on the protection action setting for OPP.

If the protection action is set to LOAD OFF, the load turns off.



If the protection action is set to LIMIT, the PLZ- 4W sinks current as a constant-power load at point B. Even if you attempt to decrease the resistance to increase the current, the current will not increase beyond point B. If you increase the resistance to decrease the input current, overpower protection (OPP) is cleared. The PLZ-4WH returns to constant resistance (CR) mode, and the operating point moves along segment AB.

Point B	LOAD OFF	The load is turned off (no current flows). The PLZ-4WH stops operating as a load.
	LIMIT	The PLZ-4WH switches out of constant resistance (CR) mode. Overpower protection (OPP) continues, and the PLZ-4WH operates as a constant-power load.

### Transition of the operating point: overcurrent protection (OCP)

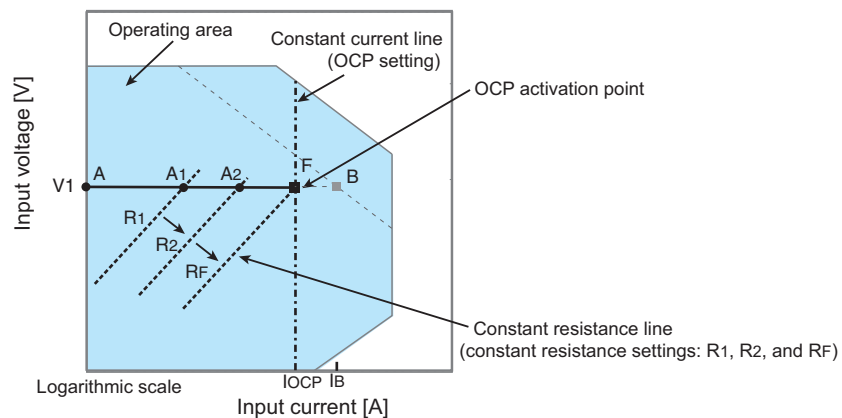

If the overcurrent protection (OCP) setting  $IOCP$  is less than the current value  $I_B$  at point B, when the PLZ-4WH resistance is decreased ( $R_1 \rightarrow R_2 \rightarrow R_F$ ) so that the input current (load current) increases, with the voltage of the constant-voltage power supply at  $V_1$ , the operating point moves along segment AF ( $A_1 \rightarrow A_2 \rightarrow F$ ). When point F is reached, overcurrent protection (OCP) is activated.

At this point, one of two types of operations occurs, depending on the protection action setting for OCP. If the protection action is set to LOAD OFF, the load turns off.

If the protection action is set to LIMIT, the PLZ- 4W sinks current as a constant-current load at point F. Even if you attempt to decrease the resistance to increase the current, the current will not increase beyond point F. If you increase the resistance to decrease the input current, overcurrent protection (OCP) is cleared. The PLZ-4WH returns to constant resistance (CR) mode, and the operating point moves along segment AF.

Point F	LOAD OFF	The load is turned off (no current flows). The PLZ-4WH stops operating as a load.
	LIMIT	The PLZ-4WH switches out of constant resistance (CR) mode. Overcurrent protection (OCP) continues, and the PLZ-4WH operates as a constant-current load.

App.

## How constant power (CP) mode works

In CP mode, the PLZ-4WH sinks current so that the power consumed inside the electronic load is constant.

### Constant power mode operation

When the PLZ-4WH is used in constant power (CP) mode, it operates as a constant-power load as shown in the figure below. When the voltage ( $V_1$ ) of the constant-voltage power supply increases, the input current ( $I$ ) decreases so that the power  $P$  consumed by the PLZ-4WH is kept constant ( $P = V \times I$ ). In the figure below,  $P = V_2 \times I_2 = V_3 \times I_3$ .

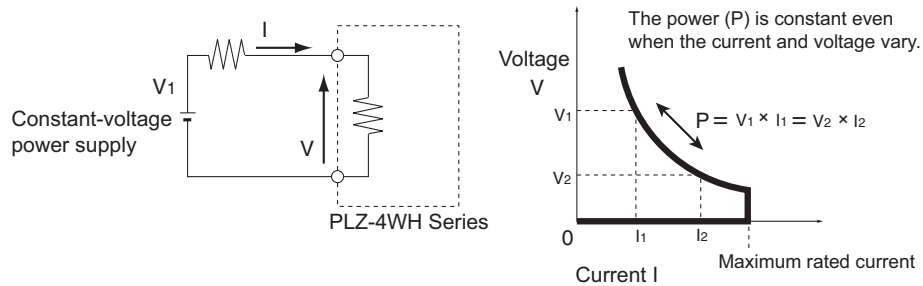

### Transition of the operating point: overcurrent protection (OCP)

In this example, we will assume that the PLZ-4WH is being used in constant power (CP) mode to test the load characteristic of a constant-voltage power supply.

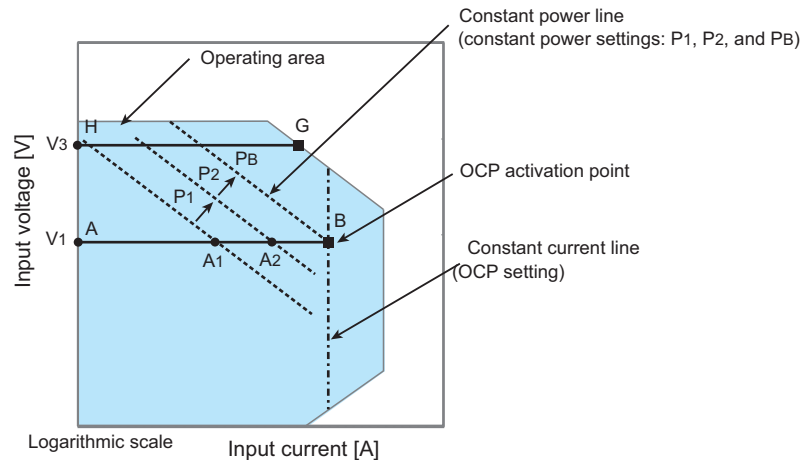

#### ■ Operation on segment AB

If the voltage of the constant-voltage power supply is set to  $V_1$  and the power of the PLZ-4WH is increased ( $P_1 \rightarrow P_2 \rightarrow P_B$ ), thereby increasing the input current (load current), the operating point moves along segment AB ( $A_1 \rightarrow A_2 \rightarrow B$ ).

When point B is reached, overcurrent protection (OCP) is activated. At this point, one of two types of operations occurs, depending on the protection action setting for OCP.

If the protection action is set to LOAD OFF, the load turns off.

If the protection action is set to LIMIT, the PLZ-4WH sinks current as a constant-current load at point B. Even if you attempt to increase the input current, the current will not increase beyond point B. If you decrease the input current, overcurrent protection (OCP) is cleared. The PLZ-4WH returns to constant power (CP) mode, and the operating point moves along segment AB.

Point B	LOAD OFF	The load is turned off (no current flows). The PLZ-4WH stops operating as a load.
	LIMIT	The PLZ-4WH switches out of constant power (CP) mode. Overcurrent protection (OCP) continues, and the PLZ-4WH operates as a constant-current load.

#### ■ Operation on segment GH

If the voltage of the constant-voltage power supply is set to V3 and the power of the PLZ-4WH is increased (P1→P2→PB), thereby increasing the input current (load current), the operating point moves along segment GH. Point G is the maximum power in the range being used.

## How constant voltage (CV) mode works

In CV mode, the PLZ-4WH sinks current so that the voltage at the load input end of the PLZ-4WH is constant.

### Constant voltage mode operation

When the PLZ-4WH is used in constant voltage (CV) mode, it operates as a constant-voltage load (shunt regulator) as shown in the figure below. When  $V_1$  is greater than  $V$ , the input voltage  $V$  is kept constant even when the input current  $I$  varies. Current does not flow when  $V_1$  is less than or equal to  $V$ . In the figure below,  $R_1$  is the internal resistance of the constant-voltage power supply. The PLZ-4WH may operate unstably if  $R_1$  is low.

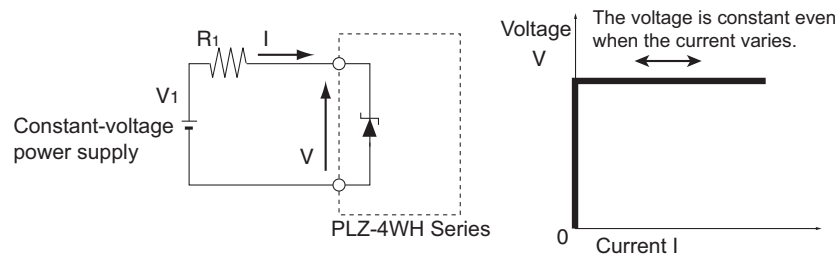

### Transition of the operating point: overpower protection (OPP)

In this example, we will assume that the PLZ-4WH is being used in constant voltage (CV) mode to test the load characteristic of a constant-voltage power supply.

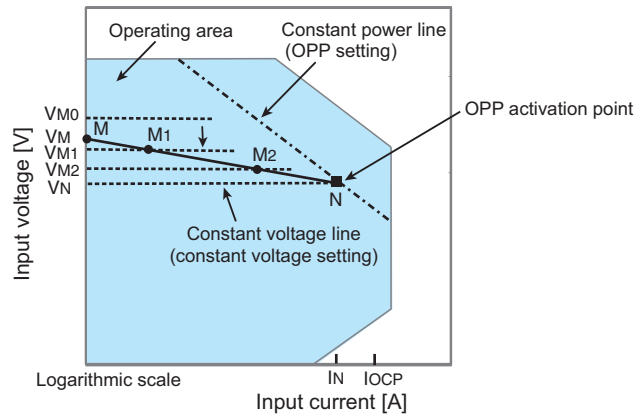

When the overcurrent protection (OCP) setting  $I_{OCP}$  is greater than current  $I_N$  at point N, the voltage of the constant voltage power supply is  $V_M$ . Current will not flow if the PLZ-4WH voltage  $V_M$  is greater than  $V_M$ . If the voltage of the PLZ-4WH is decreased so that  $V_{M0}$  is less than  $V_M$ , current starts flowing. If the voltage is decreased further ( $V_{M1} \rightarrow V_{M2} \rightarrow V_N$ ) so that the input current (load current) increases, the operating point moves along segment MN ( $M_1 \rightarrow M_2 \rightarrow N$ ).

When point N is reached, overpower protection (OPP) is activated. At this point, one of two types of operations occurs, depending on the protection action setting for OPP.

If the protection action is set to LOAD OFF, the load turns off.

If the protection action is set to LIMIT, the PLZ-4WH sinks current as a constant-power load at point N. Even if you attempt to decrease the voltage, the current will not increase beyond point N. If you increase the voltage, overpower protection (OPP) is cleared. The PLZ-4WH returns to constant voltage (CV) mode, and the operating point moves along segment MN.

Point N	LOAD OFF	The load is turned off (no current flows). The PLZ-4WH stops operating as a load.
	LIMIT	The PLZ-4WH switches out of constant voltage (CV) mode. Overpower protection (OPP) continues, and the PLZ-4WH operates as a constant-power load.

### Transition of the operating point: overcurrent protection (OCP)

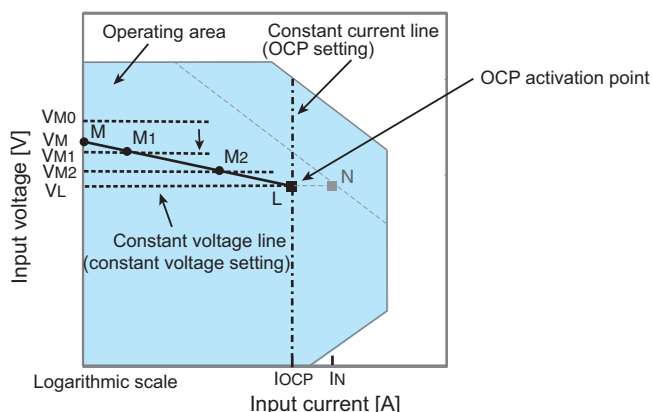

When the overcurrent protection (OCP) setting  $I_{OCP}$  is less than current  $I_N$  at point N, the voltage of the constant voltage power supply is  $V_M$ . Current will not flow if the PLZ-4WH voltage  $V_{M0}$  is greater than  $V_M$ . If the voltage of the PLZ-4WH is decreased so that  $V_{M0}$  is less than  $V_M$ , current starts flowing. If the voltage is decreased further ( $V_{M1} \rightarrow V_{M2} \rightarrow V_L$ ) so that the input current (load current) increases, the operating point moves along segment ML ( $M1 \rightarrow M2 \rightarrow L$ ).

When point L is reached, overcurrent protection (OCP) is activated. At this point, one of two types of operations occurs, depending on the protection action setting for OCP.

If the protection action is set to LOAD OFF, the load turns off.

If the protection action is set to LIMIT, the PLZ-4WH sinks current as a constant-current load at point L. Even if you attempt to decrease the voltage, the current will not increase beyond point L. If you increase the voltage, overcurrent protection (OCP) is cleared. The PLZ-4WH returns to constant voltage (CV) mode, and the operating point moves along segment ML.

App.

Point L	LOAD OFF	The load is turned off (no current flows). The PLZ-4WH stops operating as a load.
	LIMIT	The PLZ-4WH switches out of constant voltage (CV) mode. Overcurrent protection (OCP) continues, and the PLZ-4WH operates as a constant-current load.

# How constant current and constant voltage (CC+CV) mode works

On the PLZ-4WH, you can add constant voltage (CV) mode to constant current (CC) mode.

## Constant current and constant voltage mode operation

When the PLZ-4WH is used in constant current and constant voltage mode (CC+CV), it operates as a constant-current load and a constant-voltage load (shunt regulator) as shown in the figure below. Operating as a constant-current load, the PLZ-4WH sinks the specified current ( $I$ ) regardless of the output voltage  $V_M$  of the constant-voltage power supply. When  $V_M$  is greater than  $V$ , the PLZ-4WH operates as a constant-voltage load and keeps input voltage  $V$  constant even when the input current  $I$  varies. Current does not flow when  $V_M$  is less than or equal to  $V$ .

The PLZ-4WH switches between the two modes automatically. In the figure below,  $R_1$  is the internal resistance of the constant-voltage power supply. In constant-voltage (CV) mode, the PLZ-4WH may operate unstably if  $R_1$  is low.

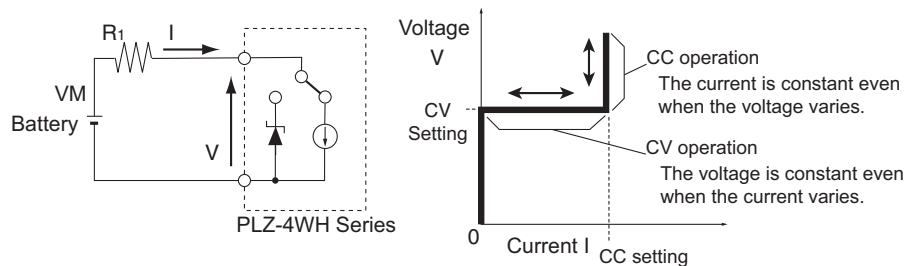

## Transition of the operating point: overpower protection (OPP)

In this example, we will assume that the discharge characteristic of a battery is being measured.

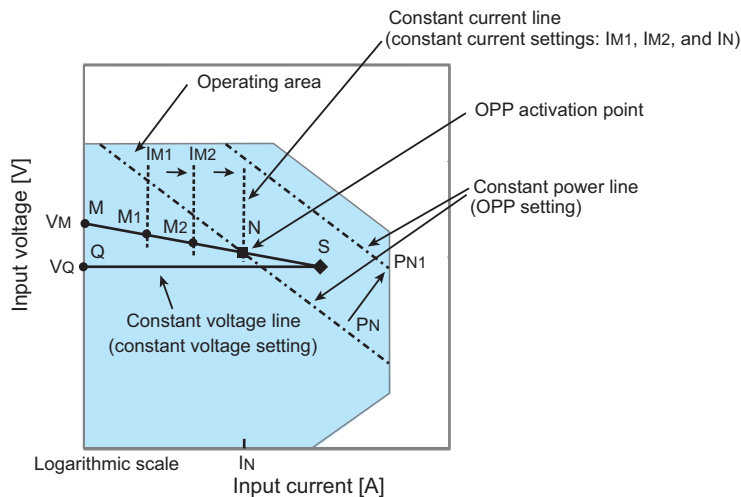

The battery voltage is  $V_M$ . In constant current (CC) mode, if the current is increased ( $I_{M1} \rightarrow I_{M2} \rightarrow I_N$ ) so that the input current (load current) increases, the operating point moves along segment  $MN$  ( $M_1 \rightarrow M_2 \rightarrow N$ ).

When the overpower protection (OPP) setting is  $PN$ , OPP is activated when point  $N$  is reached.

At this point, one of two types of operations occurs, depending on the protection action setting for OPP.

If the protection action is set to LOAD OFF, the load turns off.

If the protection action is set to LIMIT, the PLZ-4WH sinks current as a constant-power load at point N. Even if you attempt to increase the current, it will not increase beyond point N. If you decrease the current, overpower protection (OPP) is cleared. The PLZ-4WH returns to constant current (CC) mode, and the operating point moves along segment MN.

Point N	LOAD OFF	The load is turned off (no current flows). The PLZ-4WH stops operating as a load.
	LIMIT	The PLZ-4WH switches out of constant current (CC) mode. Overpower protection (OPP) continues, and the PLZ-4WH operates as a constant-power load.

If the overpower protection (OPP) setting is PN1, because overpower protection (OPP) is not activated as the current is increased, the operating point reaches point S.

At point S, the PLZ-4WH switches to constant voltage (CV) mode. The voltage is fixed at the user-specified voltage VQ. The operating point moves along segment QS. The current is determined by the voltage and internal resistance of the battery.

## How constant resistance and constant voltage (CR+CV) mode works

On the PLZ-4WH, you can add constant voltage (CV) mode to constant resistance (CR) mode.

### Constant resistance and constant voltage mode operation

When the PLZ-4WH is used in constant resistance and constant voltage mode (CR+CV), it operates as a constant-resistive load and a constant-voltage load (shunt regulator) as shown in the figure below. When the PLZ-4WH operates as a constant-resistive load and the voltage  $V_M$  of the constant-voltage power supply varies, the PLZ-4WH sinks current to maintain  $I = V/R$ , with the specified resistance value  $R$  fixed. When  $V_M$  is greater than  $V$ , the PLZ-4WH operates as a constant-voltage load and keeps input voltage  $V$  constant even when the input current  $I$  varies. Current does not flow when  $V_M$  is less than or equal to  $V$ .

The PLZ-4WH switches between the two modes automatically. In the figure below,  $R_1$  is the internal resistance of the constant-voltage power supply. In constant-voltage (CV) mode, the PLZ-4WH may operate unstably if  $R_1$  is low.

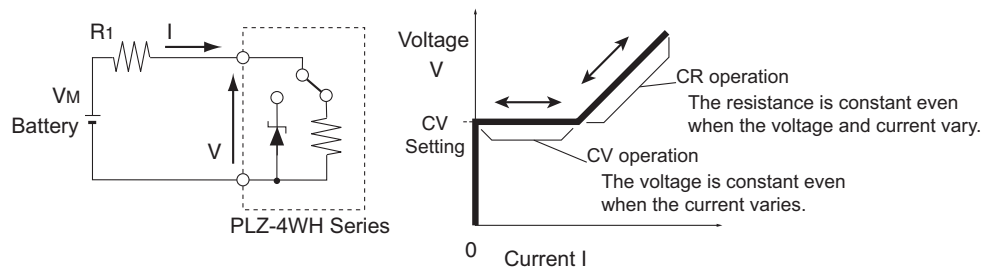

### Transition of the operating point: overpower protection (OPP)

In this example, we will assume that the discharge characteristic of a battery is being measured.

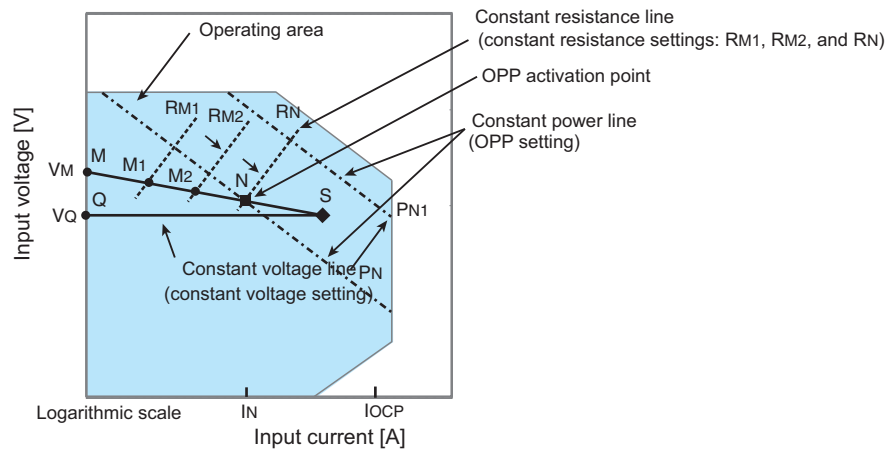

When the overcurrent protection (OCP) setting  $I_{OCP}$  is greater than current  $I_N$  at point N, the voltage of the battery is  $V_M$ . In constant resistance (CR) mode, if the resistance is reduced ( $R_{M1} \rightarrow R_{M2} \rightarrow R_N$ ) so that the input current (load current) increases, the operating point moves along segment MN ( $M_1 \rightarrow M_2 \rightarrow N$ ).

When the overpower protection (OPP) setting is  $P_N$ , OPP is activated when point N is reached.

At this point, one of two types of operations occurs, depending on the protection action setting for OPP. If the protection action is set to LOAD OFF, the load turns off. If the protection action is set to LIMIT, the PLZ-4WH sinks current as a constant-power load at point N. Even if you attempt to decrease the resistance to increase the current, the current will not increase beyond point N. If you increase the resistance to decrease the current, overpower protection



(OPP) is cleared. The PLZ-4WH returns to constant resistance (CR) mode, and the operating point moves along segment MN.

Point N	LOAD OFF	The load is turned off (no current flows). The PLZ-4WH stops operating as a load.
	LIMIT	The PLZ-4WH switches out of constant resistance (CR) mode. Overpower protection (OPP) continues, and the PLZ-4WH operates as a constant-power load.

If the overpower protection (OPP) setting is PN1, because overpower protection (OPP) is not activated as resistance is reduced so that the current is increased, the operating point reaches point S.

At point S, the PLZ-4WH switches to constant voltage (CV) mode. The voltage is fixed at the user-specified voltage VQ. The operating point moves along segment QS. The current is determined by the voltage and internal resistance of the battery.

### Transition of the operating point: overcurrent protection (OCP)

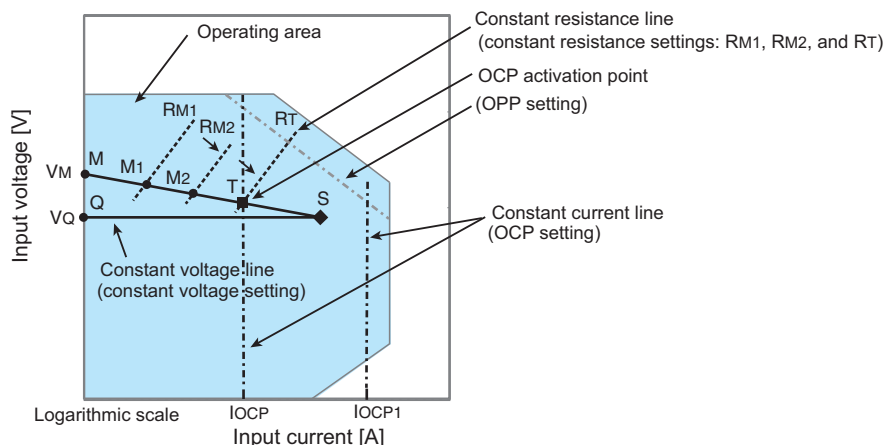

When the overcurrent protection (OCP) setting IOCP is lower than the current produced by the activation of overpower protection (OPP), the voltage of the battery is VM. In constant resistance (CR) mode, if the resistance is decreased (RM1→RM2→RT) so that the input current (load current) increases, the operating point moves along segment MT (M1→M2→T). When the overcurrent protection (OCP) setting is IOCP, overcurrent protection (OCP) is activated when point T is reached. At this point, one of two types of operations occurs, depending on the protection action setting for OCP.

If the protection action is set to LOAD OFF, the load turns off.

If the protection action is set to LIMIT, the PLZ-4WH sinks current as a constant-current load at point T. Even if you attempt to decrease the resistance to increase the current, the current will not increase beyond point T. If you increase the resistance to decrease the current, overcurrent protection (OCP) is cleared. The PLZ-4WH returns to constant resistance (CR) mode, and the operating point moves along segment MT.

Point T	LOAD OFF	The load is turned off (no current flows). The PLZ-4WH stops operating as a load.
	LIMIT	The PLZ-4WH switches out of constant resistance (CR) mode. Overcurrent protection (OCP) continues, and the PLZ-4WH operates as a constant-current load.

If the overcurrent protection (OCP) setting is IOCP1, because overcurrent protection (OCP) is not activated as resistance is reduced so that the current is increased, the operating point reaches point S.

At point S, the PLZ-4WH switches to constant voltage (CV) mode. The voltage is fixed at the user-specified voltage VQ. The operating point moves along segment QS. The current is determined by the voltage and internal resistance of the battery.

App.

## Operating areas of each model

### Operating areas of the PLZ164WH

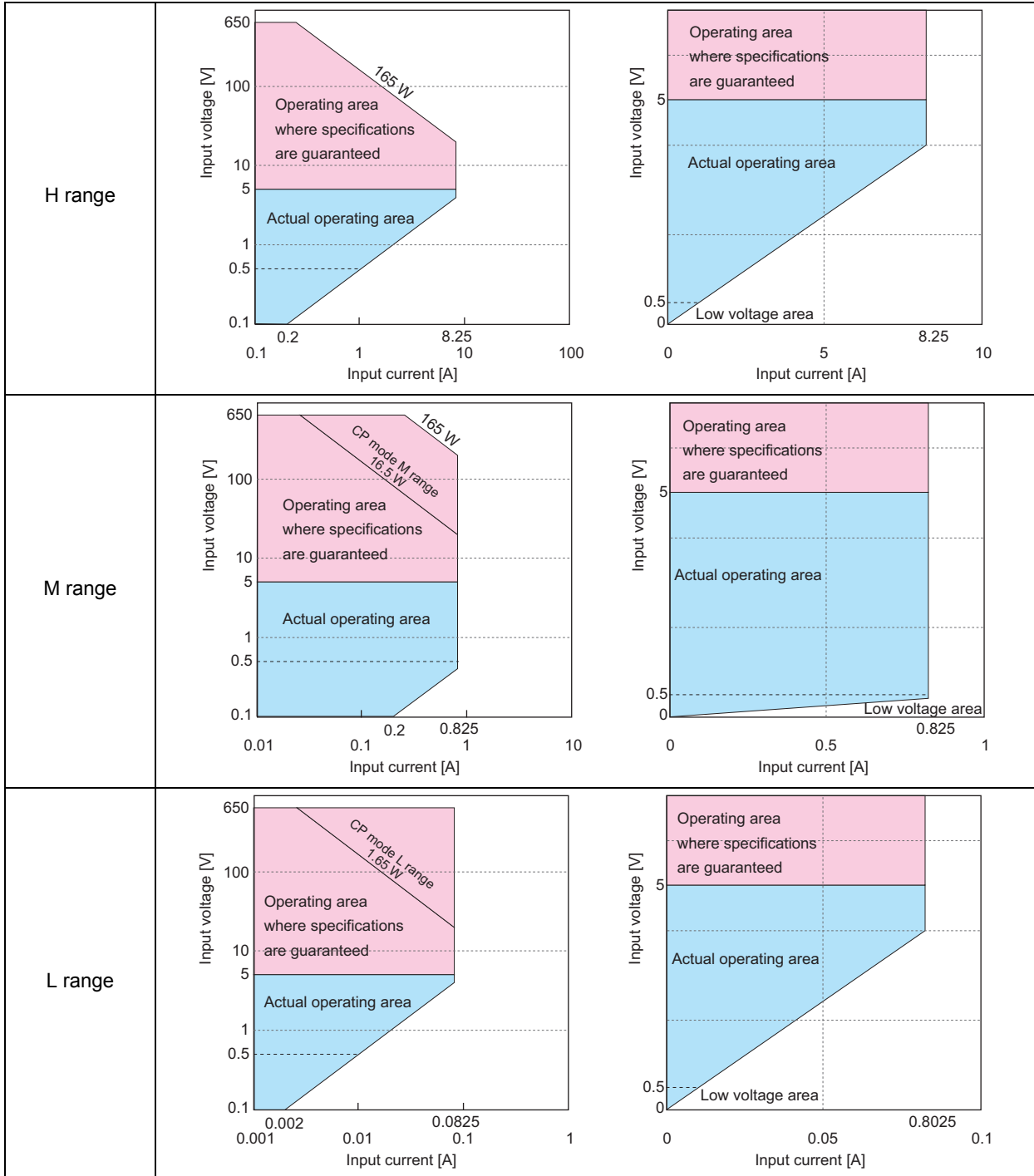

### Operating areas of the PLZ334WH

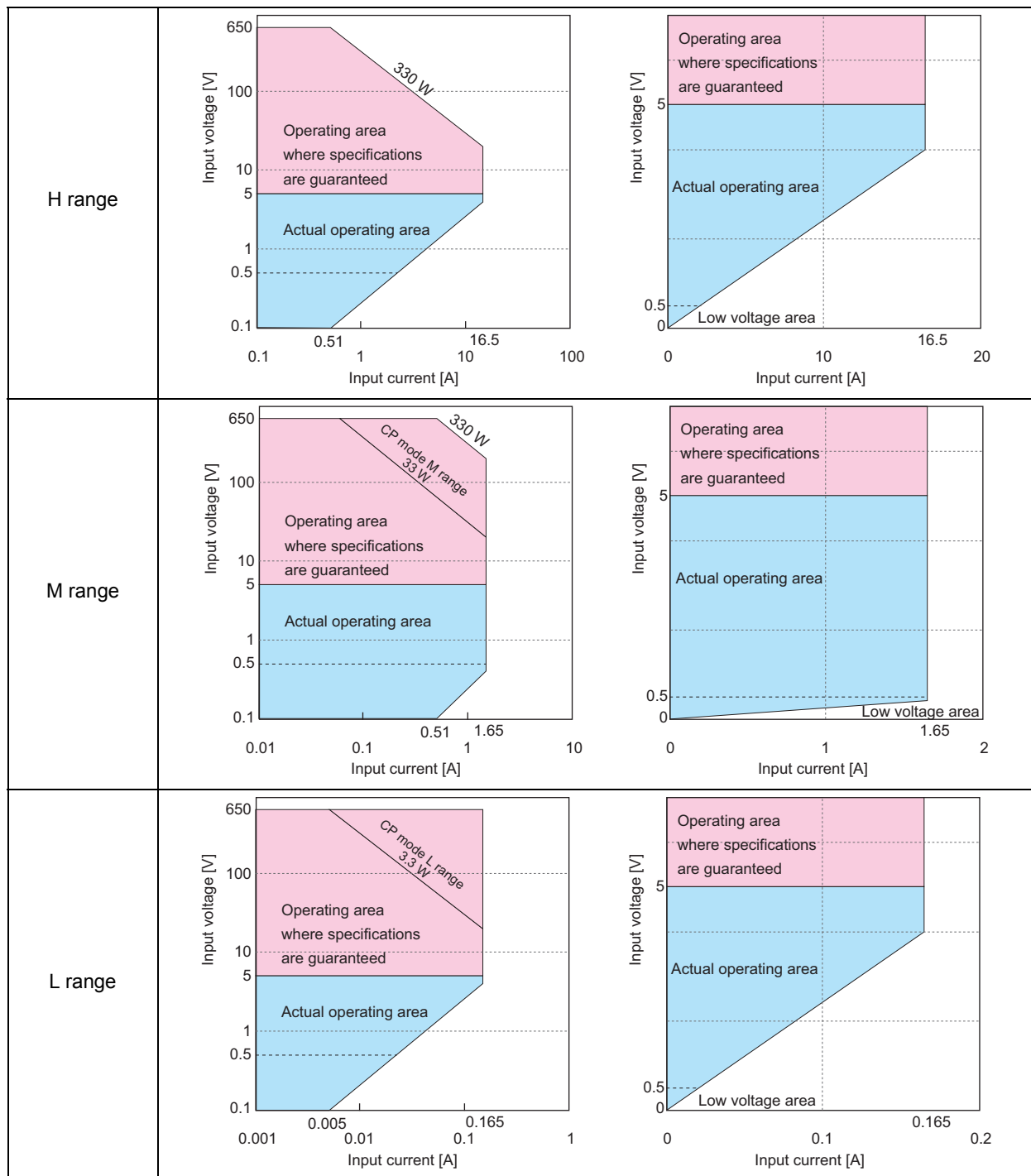

App.

### Operating areas of the PLZ1004WH

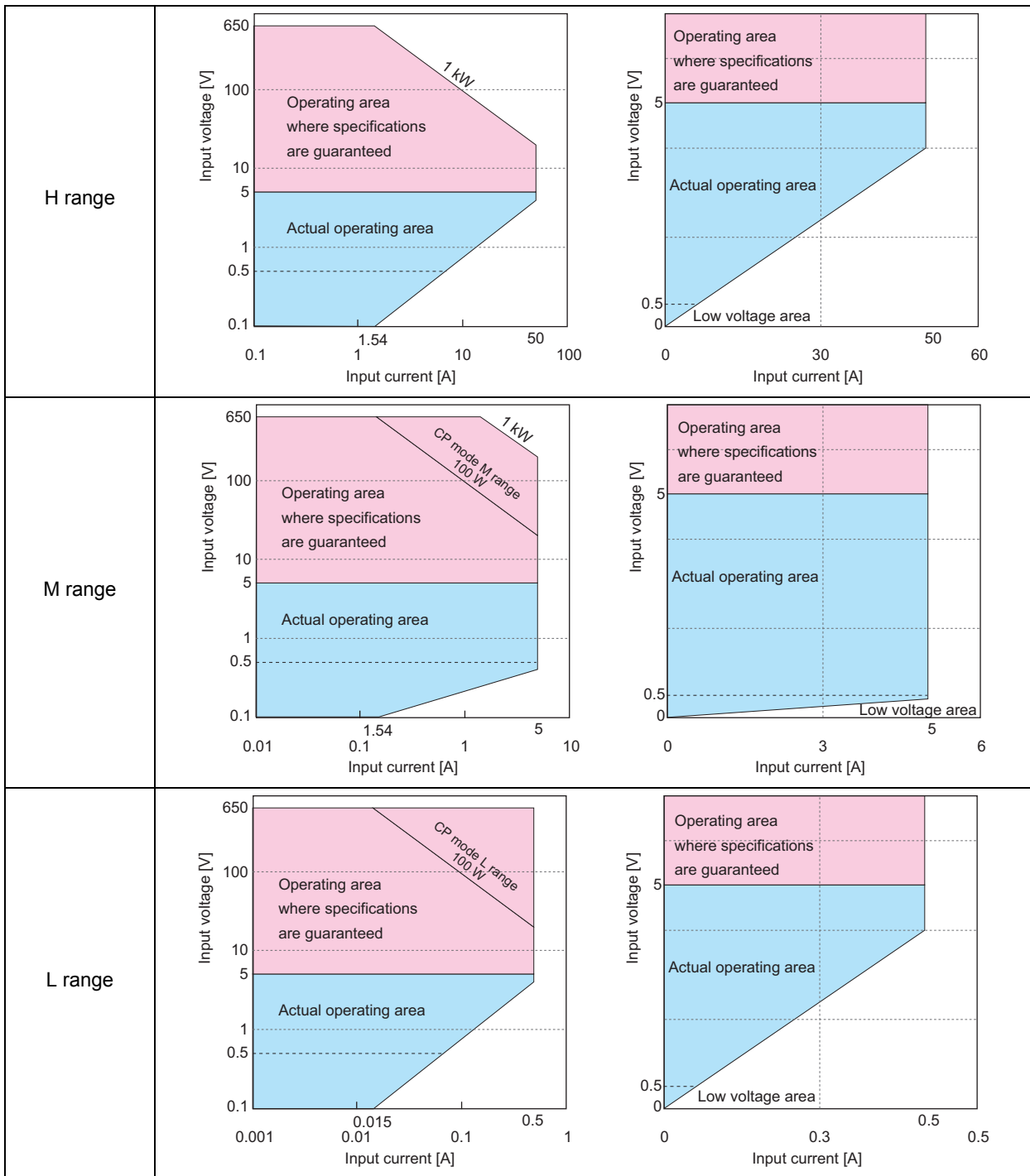

# B

## Sequence Program Creation Table

For normal sequence

Program name:		Date:	By:
Program number (1 to 10)			
Memo (Up to 11 characters)			
Operation mode	CC, CR, CV, CP		
Range Current (A) -- Voltage (V)	(A) -- (V)		
Loop (1 to 9999)			
Last Load (OFF/ON)	OFF, ON		
Last Set			
Chain (OFF, 1 to 10)			

Step number	Setting (mA, mS, V, W)	Execution time (h:min:s:ms)	LOAD	RAMP	TRIG	PAUSE	Note
1							
2							
3							
4							
5							
6							
7							
8							
9							
10							
11							
12							
13							
14							
15							
16							
17							
18							
19							
20							

App.

Entry example

Program name: Example sequence of chapter 4: PLZ164WH	
Date: _____ By: _____	
Program number (1 to 10)	1
Memo (Up to 11 characters)	Program1
Operation mode	CC,
Range Current (A) -- Voltage (V)	8.25 (A) -- 650 (V)
Loop (1 to 9999)	0001
Last Load (OFF/ON)	OFF,
Last Set	0
Chain (OFF, 1 to 10)	2

Step number	Setting (mA, mS, V, W)	Execution time (h:min:s:ms)	LOAD	RAMP	TRIG	PAUSE	Note
1	6 A	200 s	ON	ON	OFF	OFF	
2	6 A	150 s	ON	OFF	OFF	OFF	
3	0.3 A	80 s	OFF	OFF	OFF	OFF	

Program name: Example sequence of chapter 4: PLZ164WH	
Date: _____ By: _____	
Program number (1 to 10)	2
Memo (Up to 11 characters)	Program2
Operation mode	CC
Range Current (A) -- Voltage (V)	8.25 (A) -- 650 (V)
Loop (1 to 9999)	0002
Last Load (OFF/ON)	OFF
Last Set	0
Chain (OFF, 1 to 10)	OFF

Step number	Setting (mA, mS, V, W)	Execution time (h:min:s:ms)	LOAD	RAMP	TRIG	PAUSE	Note
1	8.1 A	200 s	ON	ON	OFF	OFF	
2	3 A	50 s	ON	OFF	OFF	OFF	
3	7.2 A	150 s	ON	ON	OFF	OFF	

# C Options

The following options are available for the PLZ-4WH. For details, contact your Kikusui agent or distributor.

## ■ Rack-mount frames and brackets

These are rack mounting options. To support the PLZ-4WH, attach an angle support to it that is appropriate for the frame.

Name	Model	Appropriate Model	Explanation
Rack adapter	KRA3	PLZ164WH	For an EIA inch rack
	KRA150	PLZ334WH	For a JIS millimeter rack
Rack mount brackets	KRB3-TOS	PLZ1004WH	For an EIA inch rack
	KRB150-TOS		For a JIS millimeter rack

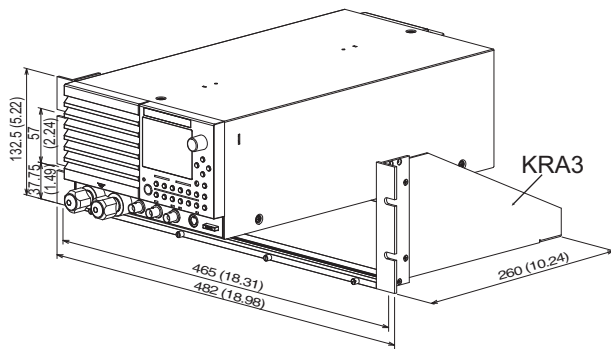

Rack adapter

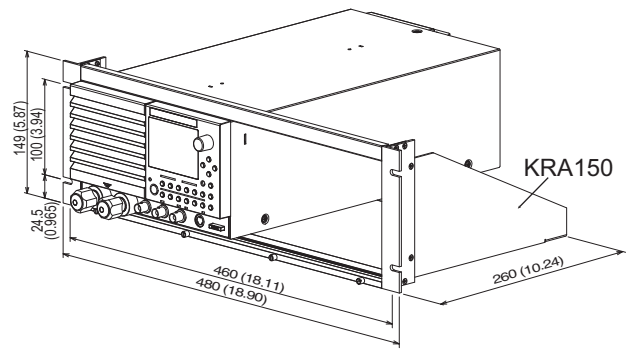

Unit: mm (inches)

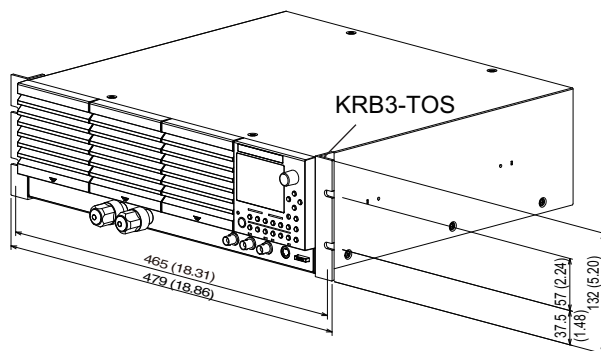

Rack mount brackets

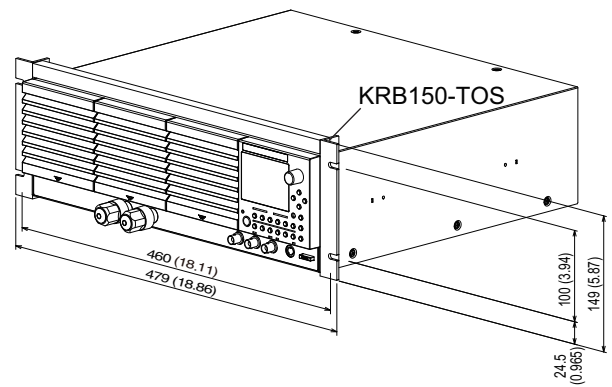

Unit: mm (inches)

App.

### ■ Analog remote control connector kit (OP01-PLZ-4W)

A kit for connecting to the EXT CONT connector on the rear panel.

Socket	1 pc.
Pins	20 pcs.
Protection cover	1 set

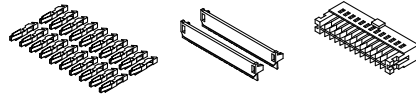

### ■ Flat cable for connecting units for parallel operation

This flat cable is used to connect signal wires for parallel operation. It comes in two lengths.

Model	Length	Explanation
PC01-PLZ-4W	300 mm	For use when you aren't using boosters (PLZ2004WHB), or when you are connecting boosters to each other.
PC02-PLZ-4W	550 mm	For use when you are connecting a PLZ-4WH series unit to boosters (PLZ2004WHB).

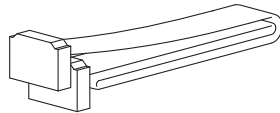



# INDEX

-S 25

+CV mode 32, 34

+S 25

## A

A key 9

ABC preset memory 47

accessories 12, 127

ALARM is activated 118

alarms, clearing 53

analog external control 126

auto load-off timer 55

## B

B key 9

## C

C key 9

calibrated items 110

calibration 110

CC mode 32, 131

CC mode calibration 112

CC+CV mode 33, 138

Chain 63

closed-circuit voltage 55

coarse adjustment 28

communication function 126

conductance 34

constant current and constant  
voltage mode 138

constant current mode 32, 131

constant power mode 37, 134

constant resistance and constant  
voltage mode 140

constant resistance mode 34, 132

constant voltage mode 36, 136

Count Time 55

CP mode 37, 134

CR mode 34, 132

CR+CV mode 35, 140

current monitor output 100

CURSOR 9

Cut Off Time 55

cutoff voltage 55

CV mode 36, 136

CV mode calibration 114

## D

default settings, list 130

DEL key 9

dimensions 128

DIRECT 48

display contrast, adjusting 28

## E

elapsed time display 55

ENTER key 9

EXT CONT connector pin  
arrangement 85

## F

fast sequence 60, 72

feet, removal 13

FILL function 75

fine adjustment 28

front-panel BNC terminal 126

fundamental setting entry condition  
15

## G

gain value 110

## H

handle, removing 13

## I

initial drift 111

inrush current 127

INS key 9

## J

J1 connector 84

## K

key icon 43

keylock function 43

## L

Last Load 63, 73

Last Set 63, 73

LOAD 65

load on and load off 29

LOCAL key 9

lock function 43

LOCK key 9

Loop 63, 73

## M

malfunctions and causes 117

Memo 63, 73

menu settings 56

Mode 63, 73

## N

normal sequence 60

## O

OCP 52

offset value 110

operating area of the PLZ-4WL 130

operating areas of each model 142

operating humidity range 127

operating temperature range 127

operation modes 31

OPP 52

Oscillation 19

overcurrent protection 52

overhaul 109

overpower protection 52

## P

panel operation basics 28

Parallel operation

using boosters 102

using the same type 102

PAUSE 65

Popup menu 28

power consumption 127

POWER switch 8

preset memory 46

recalling 48

saving 47

program 62, 72

program number 63, 73

protection functions 51

## R

RAMP 65

Range 63, 73

RECALL key 9

remote sensing 25

response 54

response speed 54

REV 51, 53

reverse voltage detection 51, 53

ROM version 2

rotary knob 28

RPTSTEP 73

## S

SAFETY 48

sequence examples 66, 76  
sequences, execution 79  
serial number 10  
setup memory 46, 49  
    recalling 50  
    saving 49  
SHIFT key 9, 28  
short function 42  
short icon 42  
slew rate 40  
soft start 41  
step 62, 72  
storage humidity range 127  
storage temperature range 127  
STORE key 9  
switching function 38

## **T**

TIME BASE 73  
time measurement 55  
TRIG 65  
trigger signal output 100

## **U**

undervoltage protection 53  
UVP 53

## **V**

version 2  
version, checking 16  
voltage measurement 55

## **W**

warm-up 111  
weight 127



## KIKUSUI ELECTRONICS CORP.

---

1-1-3 Higashiyamata, Tsuzuki-ku, Yokohama,  
224-0023, Japan  
Tel: +81-45-593-7570 Fax: +81-45-593-7571



Website

<http://www.kikusui.co.jp/en>