

# User's Manual

Electronic Load  
PLZ-5WH2 Series

**PLZ1005WH2**

**PLZ2005WH2**

**PLZ4005WH2**

**PLZ12005WH2**

**PLZ20005WH2**

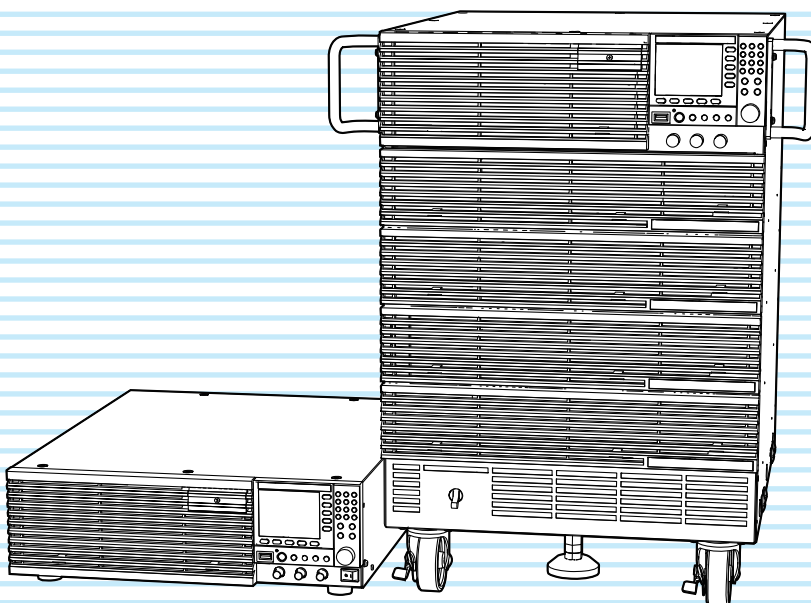

**Contents 6**

**Component Names 10**

**Preparation 16**

**Basic Functions 25**

**Advanced Functions 65**

**Sequence Function 89**

**External Control 108**

**Parallel Operation 121**

**System Settings 126**

**Maintenance 144**

**Specifications 145**

**Appendix 160**









## About Operation Manual

This manual provides an overview of the product and notes on usage. It also explains how to configure it, operate it, perform maintenance on it, and so on. Read this manual thoroughly before use, and use the product properly.

### Intended readers

These manuals are intended for users of this product and their instructors. The manual assumes that the reader has knowledge about power supplies.

### Manual construction

- User's manual  (this manual)  
This document is intended for first-time users of this product. It provides an overview of the product, notes on usage, and specifications. It also explains how to connect the product, configure the product, operate the product, perform maintenance on the product, and so on.
- Communication Interface Manual   
This document contains details about remote control. It is written for readers with sufficient basic knowledge of how to control testers and measuring instruments using SCPI commands.
- Quick Reference    
This document briefly explains the control panel and the basic operation of it.
- Setup Guide    
This document is intended for first-time users of the product. It gives an overview of the product, connecting procedures, safety precautions etc. Please read this manual before you operating the product.
- Safety Information    
This document contains general safety precautions. Keep them in mind and make sure to observe them.

PDF files are included in the accompanying CD-ROM. You can view the PDF files using Adobe Reader.

You can download the most recent version of these manuals from the Kikusui Electronics Corporation website.

### Firmware versions that this manual covers

This manual applies to products with firmware versions 2.2X.

For information on how to check the firmware version, see "Displaying the Device Information" (p. 143).

When contacting us about the product, please provide us with the following information.

The model (marked in the top section of the front panel)

Firmware version (p. 143)

The serial number (marked on the rear panel)

### Trademarks

All company names and product names used in this manual are trademarks or registered trademarks of their respective companies.

### Copyright

Reproduction and reprinting of this operation manual, whole or partially, without our permission is prohibited.

Both unit specifications and manual contents are subject to change without notice.

© Copyright 2019 Kikusui Electronics Corporation

### Open Source Software

This product contains open source software under the licensing terms of GNU General Public License (GPL), GNU LESSER General Public License (LGPL), and other licenses. For details, see the following URL.

<https://rddocuments.kikusui.co.jp/oss/plz5wh>

## Accessories

### Common to all models

The attached power cord varies depending on the shipment destination.

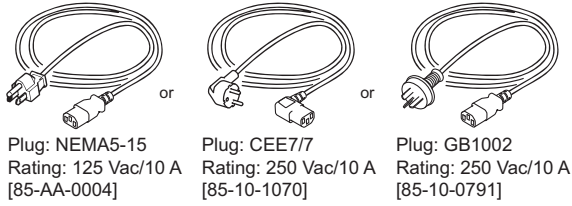

- Power cord (1 pc., length: 2.5 m)

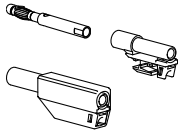

- Safety terminal adapter  
TL41 (red 1 set, black 1set)  
[87930]

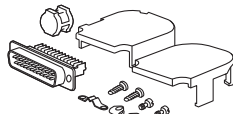

- External control  
connector kit (1 set)  
[83-20-0190]

- Safety Information (1 copy)
- Setup Guide (1 copy)
- Quick Reference  
(Japanese 1 sheet, English 1 sheet)
- CD-ROM (1 disc)

### PLZ12005WH2, PLZ20005WH2

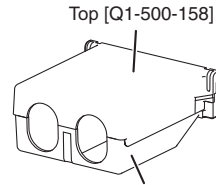

- Rear-panel DC INPUT  
terminals  
Cover (1 set)

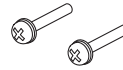

- Rear-panel DC INPUT  
terminals Cover screws  
(2 pcs.)  
[M3-112-016]

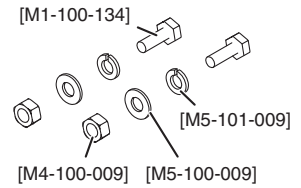

- Screw set for rear-panel  
DC INPUT terminals  
(2 sets)

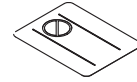

- Heavy object warning label  
(1 pc.)

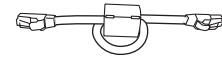

Cable length: Approx. 1 m

- Parallel operation signal  
cable kit  
[PC02-PLZ-5W]

### PLZ1005WH2, PLZ2005WH2, PLZ4005WH2

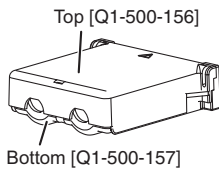

- Rear-panel DC INPUT  
terminal cover (1 set)

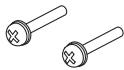

- Screws for the rear-panel DC  
INPUT terminal cover (2 pcs.)  
[M3-112-018]



- Screws for the front-panel  
DC INPUT terminals (2 pcs.)  
[M3-112-043]

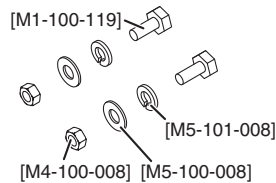

- Screw set for rear-panel  
DC INPUT terminals  
(2 sets)

Screw [M8-600-021]

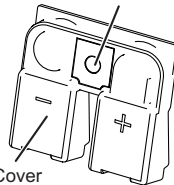

- Front-panel DC INPUT  
terminal cover (1 pc.)

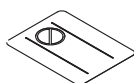

- Heavy object warning  
label (1 pc.)  
PLZ4005WH2 only

## Product Overview

The PLZ-5WH2 Series Electronic Load is a multifunctional system designed to offer the highest levels of reliability and safety. A high voltage large capacity load can be configured with this product set alone. The electronic load contains a stable and fast-response current control circuit that enables high-speed load simulations. Designed to allow high-precision current setting, it provides outstanding resolution.

The product is equipped with a color liquid crystal display (LCD) for easy viewing.

Because the electronic load comes standard with RS232C, USB, and LAN communication functions, it can easily be incorporated into a wide range of inspection systems.

## Model configurations

Model	Power	Maximum operating current	Operating voltage
PLZ1005WH2	1 kW	20 A	10 V to 1000 V
PLZ2005WH2	2 kW	40 A	
PLZ4005WH2	4 kW	80 A	
PLZ12005WH2	12 kW	240 A	
PLZ20005WH2	20 kW	400 A	

## Features

In addition to basic constant current, constant resistance, constant voltage, and constant power modes, the PLZ-5WH2 Series offers a variety of other functions.

### Larger capacity achievable in a compact form

The PLZ20005WH2 alone supports 20 kW. A compact load system can be configured. Up to four units can be operated in parallel using one of them as the master unit (up to 100 kW, 2000 A).

### Wide operating voltage range

The operating voltage range is 10 V to 1000 V. The minimum operating voltage at which current begins to flow is 1.5 V.

### Pulse and sine functions

The pulse function repeatedly executes two settings. It is suitable for transient response characteristics testing of large capacity power supplies and batteries. The sine function varies the current sinusoidally.

### Arbitrary I-V characteristics mode

Arbitrary I-V characteristics can be set by registering multiple I-V characteristic points (pairs of voltage and current values).

### Cutoff function

The load can be turned off when the elapsed time from load-on, the voltage drop, the integrated current, or the integrated power reaches the specified value.

### Synchronized Operation

Load on/off control and the execution of sequences can be synchronized among PLZ-5WH2 units.

## Data logging function

The most recent measurements (current, voltage, power, elapsed time, integrated current, integrated power) are shown on the display. Further, measurements can be stored in internal memory.

## Standard RS232C, USB, and LAN communication functions

These functions allow easy incorporation into various types of inspection systems.

## GPIO function available as an option

Using the optional GPIO converter ([p. 182](#)), the GPIO function can be used via the RS232C or USB interface. (Limitations apply to some of the functions.)

## Notations Used in This Manual

- In this manual, the PLZ1005WH2, PLZ2005WH2, PLZ4005WH2, PLZ12005WH2, or PLZ20005WH2 Electronic Load is also referred to as the PLZ-5WH2 or PLZ-5WH2 series.
- The PLZ-5WH2 has five operation modes: CC, CR, CV, CP, and ARB. The operation mode is sometimes simply referred to as the mode.
- The term "PC" is used to refer generally to both personal computers and workstations.
- The term "DUT" is used to refer generally to a device under test.
- The screen captures and illustrations used in this text may differ from the actual items.
- The following markings are used in this manual.

### WARNING

Indicates a potentially hazardous situation which, if ignored, could result in death or serious injury.

### CAUTION

Indicates a potentially hazardous situation which, if ignored, may result in slight injury or damage to the product or other property.

### NOTE

Indicates information that you should know.



Indicates a reference manual (CD-ROM) containing detailed information.



Indicates the hierarchy of items you need to select. The item to the left of this symbol indicates a higher level item.

## Safety Precautions

When using this product, be sure to observe the precautions in the Safety Information manual. Items specific to this product are given below.

### **⚠ WARNING**

- Be careful of hearing loss.  
Wear earplugs when working near the PLZ12005WH2 or PLZ20005WH2 when it is running.  
The noise sound pressure level of this product is 80 dB or less, but when this product is operated in the same place as another product with a large noise sound pressure level or when several of this product is operated simultaneously in the same place, the pressure level near the product may exceed 80 dB.

### **⚠ CAUTION**

- The exhaust air may become hot.  
Stay away from the exhaust air flow. Move this product away from installed objects to prevent the exhaust air from hitting them directly.
- Do not use or store the PLZ1005WH2, PLZ2005WH2, PLZ4005WH2 in a vertical position.  
Risk of falling over. Use the legs on the side panel of the PLZ1005WH2 or PLZ2005WH2 to temporarily stand the product up for the purpose of carrying it by the handle.
- Do not use the product where ventilation is poor.  
Heat is expelled from vents of the rear panel.  
To prevent the heat from building up and causing a fire, keep the vents at least 75 cm away from walls.  
Also, do not place objects within 75 cm of the rear panel.

## Notes on Usage

- When installing this product, be sure to observe the temperature and humidity ranges indicated below.  
Operating temperature range: 0 °C to 40 °C (32 °F to 104 °F)  
Operating humidity range: 20 %rh to 85 %rh (no condensation)
- When storing this product, be sure to observe the temperature and humidity ranges indicated below.  
Storage temperature range: -25 °C to 60 °C (-13 °F to 140 °F)  
Storage humidity range: 90 %rh or less (no condensation)
- Adequately ventilate the room in which this product is installed to keep the room temperature from rising.
- Locking the casters and applying the stopper  
The PLZ12005WH2 and PLZ20005WH2 have casters on the bottom side, so it is easy to move the product. To ensure that the product is not moved accidentally while it is being operated, use the stopper to fix the product in place, and lock the casters with your foot.

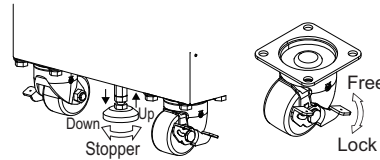

- When moving the product, be sure to release the stopper. (PLZ12005WH2, PLZ20005WH2 only)  
Loosen the stopper nut, and turn the stopper shaft to raise its base up to the bottom of the product. Provide adequate space between the base of the stopper and the floor.  
Otherwise, the stopper may hit an obstacle while the product is being moved causing the stopper shaft to break.

# Contents

About Operation Manual.....	2
Open Source Software.....	2
Accessories.....	3
Product Overview.....	4
Notations Used in This Manual.....	4
Safety Precautions.....	5
Notes on Usage.....	5
Component Names.....	10

## Preparation

Connecting the Power Cord.....	16
Checking Whether the Power Is On or Off.....	17
Turning the power on.....	17
Turning the power off.....	18
Connecting to the DUT.....	19
When connecting to the rear-panel DC INPUT terminals.....	20
When connecting to the front-panel DC INPUT terminals.....	22
Notes regarding DC INPUT terminals.....	24

## Basic Functions

Panel Operations.....	25
Switching the display.....	25
Using the function keys.....	26
Identification using color markers.....	27
Inputting numbers and characters.....	28
Changing values.....	29
Load On/Off.....	30
Setting the Operation Mode.....	31
Selecting the operation mode.....	31
Setting the current in CC mode.....	32
Setting the conductance in CR mode.....	33
Setting the resistance range of CR mode.....	34
Setting the voltage in CV mode.....	35
Setting the power in CP mode.....	36
Setting the I-V characteristics in ARB mode.....	37
Setting the Slew Rate.....	41
Pulse Function.....	42
Setting the pulse amplitude.....	42
Setting the pulse interval.....	43
Turning the pulse function on/off.....	44

Timing of trigger signal output.....	44
Sine Function.....	45
Setting the amplitude.....	45
Setting the frequency.....	46
Turning the sine function on/off.....	47
Trigger signal timing.....	47
Alarm Function.....	48
Alarm types and operation.....	48
Setting overcurrent protection (OCP).....	50
Setting overpower protection (OPP).....	51
Setting undervoltage protection (UVP).....	52
Setting watchdog protection (WDP).....	53
When an alarm occurs.....	54
Clearing an alarm.....	54
Recording Measurements.....	55
Starting measurement recording.....	55
Setting recording conditions.....	56
Aborting a measurement recording.....	59
Displaying the recorded measurement.....	60
Recording Integrated Data.....	61
Recording integrated current, integrated power, and elapsed time.....	61
Showing or hiding integrated data.....	63
Saving Measurement Data.....	64

## Advanced Functions

Changing the Response Speed.....	65
Soft Start.....	66
Remote Sensing.....	67
Connecting cables to the safety terminal adapters.....	67
Connecting the sensing cables.....	68
Enabling or disabling remote sensing.....	69
Cutoff Function.....	70
Setting the cutoff activation condition.....	70
Cutoff operation.....	72
When cutoff is activated.....	73
Types of Memory.....	74
ABC Preset Memories.....	75
Saving to ABC preset memories.....	76
Recalling ABC preset memory entries.....	77
Setup Memory.....	78
How to view the setup memory edit screen.....	78
Saving to the setup memory.....	79
Checking the setup memory details.....	80

Recalling the setup memory .....	81
Sharing the setup memory with the PLZ-5W .....	81
<b>Synchronized Operation .....</b>	<b>82</b>
Connection for synchronized operation .....	82
Synchronizing the load on/off operation .....	84
Synchronizing measurement recording .....	85
Synchronizing the start of sequences .....	86
Synchronizing the resuming of sequences .....	87
Aborting synchronized operation .....	87
<b>Remote Control .....</b>	<b>88</b>
Releasing remote control .....	88

## Sequence Function

<b>Overview of the Sequence Function .....</b>	<b>89</b>
Programs and steps .....	89
Main functions .....	89
<b>Program Configuration .....</b>	<b>90</b>
How to view the program editing screen .....	90
Creating a program .....	90
Setting the number of loops .....	91
Setting protection functions .....	92
Setting the load state at the end of the sequence .....	93
Changing a program name .....	94
Deleting a program .....	94
<b>Setting Steps .....</b>	<b>95</b>
Creating steps .....	95
Deleting steps .....	98
<b>Sequence Creation Tutorial .....</b>	<b>99</b>
Creating Program1 as a new program .....	99
Registering steps to Program1 .....	100
<b>Executing, Pausing, and Stopping Sequences ....</b>	<b>103</b>
Executing a sequence .....	103
Aborting a sequence .....	104
Pausing a sequence .....	104
Controlling the start of sequences with triggers ..	104
<b>Exporting and Importing Programs .....</b>	<b>106</b>
Exporting programs to a USB memory device ...	106
Importing programs from a USB memory device	107

## External Control

<b>Preparation for External Control .....</b>	<b>108</b>
Precautions for use at high response speeds ....	108
EXT CONT connector pin arrangement .....	109
Connecting to the EXT CONT connector .....	110
<b>Load Setting Control .....</b>	<b>112</b>
Constant current (CC), constant resistance (CR), and constant power (CP) control .....	112

Constant voltage (CV) control .....	113
Controlling the current to be superimposed on the constant current (CC) .....	114
<b>Controlling Load On/Off .....</b>	<b>115</b>
Load on/off control input .....	115
Load-on status signal output .....	116
<b>Controlling Alarms .....</b>	<b>117</b>
Alarm input .....	117
Alarm clearing input .....	117
Alarm status output .....	117
<b>Trigger Input/Output .....</b>	<b>118</b>
Trigger input .....	118
Trigger output .....	118
<b>Digital I/O .....</b>	<b>119</b>
Current/Voltage Monitor Signal Output .....	120

## Parallel Operation

<b>Overview of Parallel Operation .....</b>	<b>121</b>
Making connections for parallel operation .....	122
Performing parallel operation .....	124
Slew rate and response speed settings during parallel operation .....	125
Protection function during parallel operation (parallel operation anomaly detection) .....	125
Changing from parallel operation back to standalone operation .....	125

## System Settings

<b>Displaying and Changing CONFIG Settings ..</b>	<b>126</b>
Remote sensing .....	126
Panel settings at startup .....	127
Watchdog protection setting (WDP) .....	127
Screen saver .....	128
Key lock .....	129
Setting the beep sound .....	130
Setting the DIGITAL2 signal input/output .....	131
<b>Displaying/Changing the Interface Settings ...</b>	<b>132</b>
Resetting the interface settings .....	134
Returning the interface settings to the factory default values .....	134
<b>Displaying SCPI Errors .....</b>	<b>135</b>
<b>Setting the Date/Time .....</b>	<b>136</b>
<b>Factory Default Settings and Reset Settings .</b>	<b>137</b>
Restoring the factory default settings .....	137
Restoring the reset settings .....	138
Main settings at factory default and at reset .....	139
<b>Updating .....</b>	<b>142</b>
<b>Displaying the Device Information .....</b>	<b>143</b>



## Maintenance

Inspection .....	144
Overhaul.....	144
Backup battery replacement .....	144
Calibration .....	144

## Specifications

Rating .....	145
Constant current (CC) mode .....	145
Constant resistance (CR) mode.....	146
Constant voltage (CV) mode.....	146
Constant power (CP) mode.....	147
Arbitrary I-V characteristics (ARB) mode .....	147
Measurement function.....	148
Pulse function.....	149
Slew rate .....	149
Sine function .....	150
Soft start.....	150
Alarm function .....	151
Sequence function .....	151
Integration display .....	152
Cutoff function .....	152
Other functions .....	152
Common specifications .....	153
General specifications.....	155
External dimensions.....	156

## Appendix

Selecting the Load Cables.....	160
Methods to Stabilize Operation .....	162
Reducing the load cable inductance .....	162
Optimizing the response speed.....	163
Using remote sensing .....	163
Frequency Derating of Input Voltage .....	164
Slew Rate for Small Currents .....	165
Operating Area .....	166
Basic operation modes.....	166
Operation of the constant current (CC) mode .....	167
Operation in constant resistance (CR) mode .....	168
Constant power (CP) mode operation.....	170
Constant voltage (CV) mode operation .....	171
Operating area of each model.....	173
OPP Operation .....	175
Current limit in relation to the voltage.....	175
Response time .....	176
Waveform.....	177
Propagation Delay for External Control.....	178

Operating Range during Parallel Operation ...	179
Options .....	181
Parallel operation signal cable kit .....	181
Low inductance cable .....	181
High-voltage load cable .....	181
GPIB converter (PIA5100) .....	182
Rack mount bracket.....	183
Troubleshooting.....	186
Index.....	188



This page is intentionally blank.



# Component Names

## Front panel

PLZ1005WH2, PLZ2005WH2, PLZ4005WH2

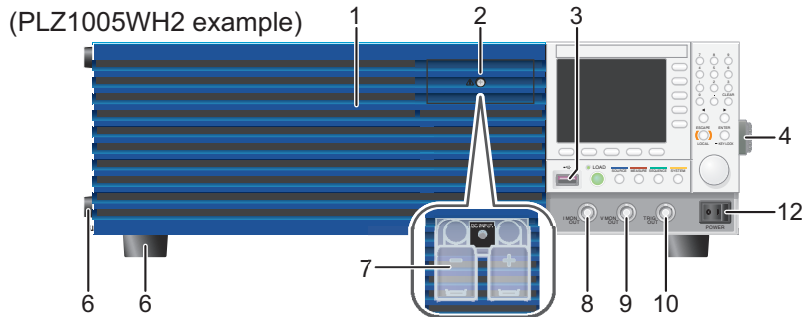

PLZ12005WH2, PLZ20005WH2

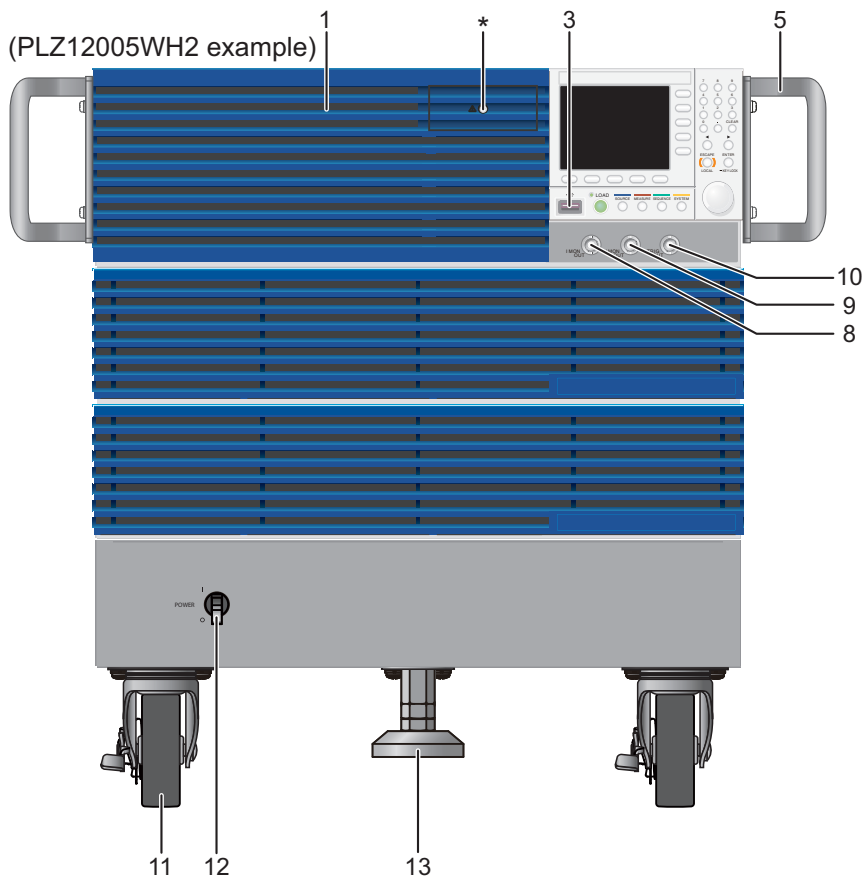

No.	Name	Description	See
1	Air inlet	Air inlet for cooling.	–
2	Protection plate	This plate protects the front-panel DC INPUT terminals. The PLZ1005WH2, PLZ2005WH2, or PLZ4005WH2 and the DUT can be connected by removing the protection plate and attaching the front-panel DC INPUT terminal cover. When not using the front-panel DC INPUT terminals, be sure to attach the protection plate.	<a href="#">p. 22</a>
3	USB port (host)	This port is used to connect an external keyboard, save measurement data, save and load setup memory, save and load programs, and update the firmware.	<a href="#">p. 28</a> <a href="#">p. 64</a> <a href="#">p. 79</a> <a href="#">p. 106</a> <a href="#">p. 142</a>
4	Handle for carrying the product.	PLZ1005WH2, PLZ2005WH2 only.	<a href="#">p. 184</a>
5	Handle	The handle is used to move the product on casters.	–
6	Feet	PLZ1005WH2/PLZ2005WH2: 4 locations on bottom panel, 4 locations on side panel. PLZ4005WH2: 4 locations on bottom panel.	<a href="#">p. 184</a>
7	Front-panel DC INPUT terminals	These terminals are used for simple connection with the DUT. The specifications are for the rear-panel DC INPUT terminals and the front-panel DC INPUT terminals may not meet the specifications.	<a href="#">p. 22</a>
8	I MON OUT connector	This connector outputs current monitor signals.	<a href="#">p. 120</a>
9	V MON OUT connector	This connector outputs voltage monitor signals.	
10	TRIG OUT terminal	This connector outputs trigger signals.	<a href="#">p. 118</a>
11	Caster and caster lock	Push the caster lock down firmly with your foot until it stays in the ON position.	<a href="#">p. 5</a>
12	POWER switch	Flipping the switch to the <b>I</b> side turns the power on and the <b>O</b> side turns the power off.	<a href="#">p. 17</a>
13	Stopper	Use to fix the product in the installation place.	<a href="#">p. 5</a>
*	Not used	Do not remove the screw.	–

# Controls

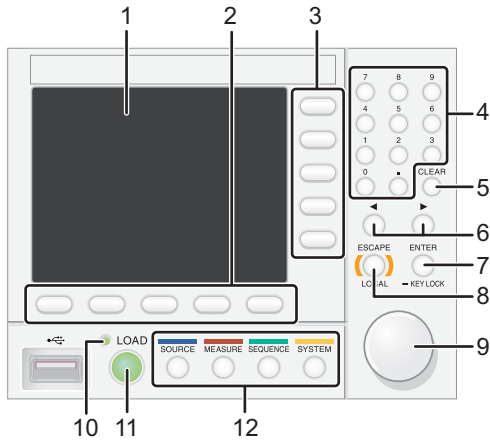

No.	Name	Function	See
1	Display	Displays the settings, measured values, and other information.	<a href="#">p. 13</a>
2	Function keys	Each function key executes the item that is displayed above that key (function area).	<a href="#">p. 26</a>
3	Sub-function keys	Each sub-function key executes the item that is displayed to the left of that key (sub-function area).	<a href="#">p. 26</a>
4	Numeric keypad	Enters values.	<a href="#">p. 28</a>
5	CLEAR key	Deletes numeric/character input.	<a href="#">p. 28</a>
6	←/→ keys	Move the cursor left and right. Select the left and right items.	<a href="#">p. 28</a>
7	ENTER key KEY LOCK key	Confirms numeric keypad input. Confirms a setting after it is selected. Hold down to lock the keys.	<a href="#">p. 28</a> <a href="#">p. 129</a>
8	ESCAPE key LOCAL key	Cancels numeric/character input. Closes the window. Returns remote control to panel control.	<a href="#">p. 28</a> <a href="#">p. 88</a>
9	Rotary knob	Selects items. Inputs numbers and characters.	<a href="#">p. 28</a>
10	LOAD LED	Lights when the load is on.	<a href="#">p. 30</a>
11	LOAD key	Switches between load on and off.	<a href="#">p. 30</a>
12	Menu keys	Switch the display.	<a href="#">p. 25</a>
	SOURCE key	Operation modes, current/resistance/power/voltage value setting, resistance range, sine function, pulse function, slew rate, alarm, response speed, soft start, cutoff function, external control, ABC preset memories, load on/off synchronization.	–
	MEASURE key	Measurement function, measurement trigger function, integrated data display, measurement data saving.	–
	SEQUENCE key	Sequence creating, executing, and saving. Sequence start trigger function.	<a href="#">p. 89</a>
	SYSTEM key	Remote sensing, system settings, interface settings, setup memory, SCPI error display, date setting, restore factory default setting, update, device information display.	<a href="#">p. 126</a>

## Display

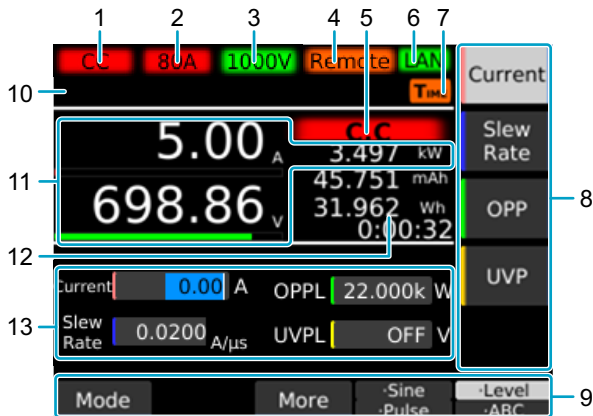

No.	Name	Function	See
1	Selected operation mode.	Displays the selected operation mode.	<a href="#">p. 31</a>
2	Current range	Displays the current range (1 range). Changes to pink color when L range of CR mode is specified.	–
3	Voltage range	Displays the voltage range (1 range).	–
4	Remote	Indicates that the product is being controlled remotely.	<a href="#">p. 88</a>
5	Operation mode in use	Displays the operation mode in use.	<a href="#">p. 31</a>
6	LAN	Displays the LAN connection status. Green: Communication enabled. Orange: Preparing for communication. Red: Not connected.	–
7	Icons	–	–
		Indicates that the pulse function is running.	<a href="#">p. 44</a>
		Indicates that the sine function is running.	<a href="#">p. 47</a>
		Indicates that measured values are being recorded.	<a href="#">p. 55</a>
		Indicates that the cutoff function is enabled.	<a href="#">p. 70</a>
		Cutoff cause: Elapsed time activation, voltage drop activation	
		Cutoff cause: Integrated current activation, integrated power activation	
		Indicates that remote sensing is in progress.	<a href="#">p. 67</a>
		Indicates that key lock is on. The key lock level is indicated with a number.	<a href="#">p. 129</a>
		Indicates that a sequence is running.	<a href="#">p. 103</a>
		External contact state and input logic setting (load on/off control).	<a href="#">p. 116</a>
		Indicates that an SCPI error has occurred. The number of error incidents (up to 16) is displayed numerically.	<a href="#">p. 135</a>
8	Sub-function area	Indicates that execution is possible with the keys (sub-function keys) in the right side of the display.	<a href="#">p. 26</a>
9	function area	Indicates that execution is possible with the keys (function keys) at the bottom of the display.	<a href="#">p. 26</a>
10	Message area	Displays alarm messages.	<a href="#">p. 48</a>
11	Measured values	The current, voltage, and power are displayed. The load input ratio for each rating is displayed in bar graph form under the current value and voltage value.	–
12	Integrated data	Displays the integrated data when integrated data display is enabled.	<a href="#">p. 63</a>
13	Value	Displays load values (current, conductance, voltage, power) and other settings such as slew rate and alarm operating conditions.	–

# Rear panel

## PLZ1005WH2, PLZ2005WH2, PLZ4005WH2

(PLZ1005WH2 example)

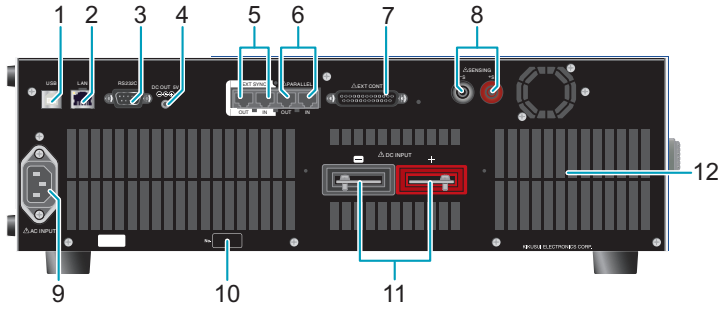

## PLZ12005WH2, PLZ20005WH2

(PLZ12005WH2 example)

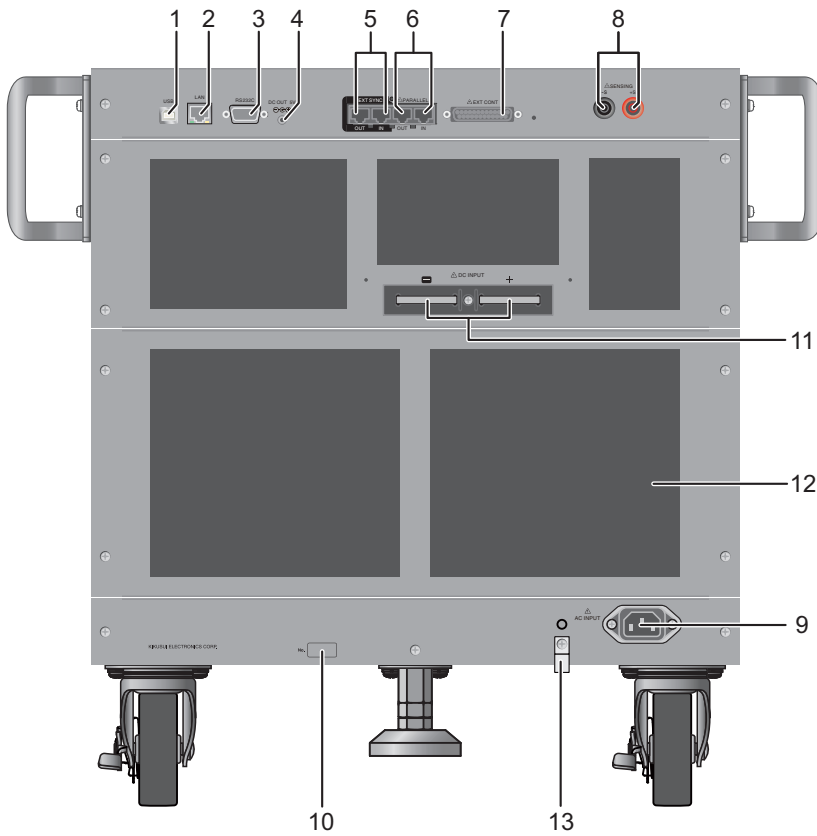

No.	Name	Function	See
1	USB port (device)	These are used for remote control.	 Interface Manual
2	LAN port		
3	RS232C port		
4	DC OUT connector	This connector is used during GPIB converter (option) use.	<a href="#">p. 182</a>
5	EXT SYNC connector	This connector is used for synchronized operation. A cover for the pins is provided.	<a href="#">p. 82</a>
6	PARALLEL connector	This connector is used for parallel operation. A cover for the pins is provided.	<a href="#">p. 122</a>
7	EXT CONT connector	This connector is used for external control. A cover for the pins is provided.	<a href="#">p. 108</a>
8	SENSING terminals	These terminals are used for remote sensing.	<a href="#">p. 67</a>
9	AC INPUT connector	This connector is used to connect the power cord.	<a href="#">p. 16</a>
10	Serial number	The product's serial number.	–
11	Rear-panel DC INPUT terminals	These terminals are used to connect the DUT and the product.	<a href="#">p. 19</a>
12	Air outlet	Air outlet for cooling.	–
13	Cord anchor	This anchor is used to fix the power cord in place.	–



# Preparation

## Connecting the Power Cord

**⚠ WARNING** Risk of electric shock.

- This product is IEC Safety Class I equipment (equipment with a protective conductor terminal). Be sure to ground the product to prevent electric shock.
- The product is grounded through the power cord ground wire. Connect the protective conductor terminal to earth ground.

**NOTE**

- Use the supplied power cord to connect to the AC line. If the supplied power cord cannot be used because the rated voltage or the plug shape is incompatible, have a qualified engineer replace it with an appropriate power cord that is 3 m or less in length. If obtaining a power cord is difficult, contact your Kikusui agent or distributor.
- The power cord with a plug can be used to disconnect the product from the AC power line in an emergency.
- Secure adequate space around the power plug. Do not insert the power plug to an outlet where accessibility to the plug is poor. And, do not place objects near the outlet that would result in poor accessibility to the plug.
- Do not use the supplied power cord with other instruments.

This product is designed as an equipment of IEC Overvoltage Category II (energy-consuming equipment supplied from a fixed installation).

**1** Turning the POWER switch off (○)

**2** Check that the AC power line meets the nominal input rating of the product.

The product can receive a nominal line voltage in the range of 100 Vac to 240 Vac at 50 Hz or 60 Hz. (Frequency range: 47 Hz to 63 Hz)

**3** Connect the power cord to the rear-panel AC INPUT.

For the PLZ12005WH2 or PLZ20005WH2, if necessary, secure the power cord with the cord anchor.

**4** Insert the power plug to an outlet with a ground terminal.

This completes the setting.

# Checking Whether the Power Is On or Off

## Turning the power on

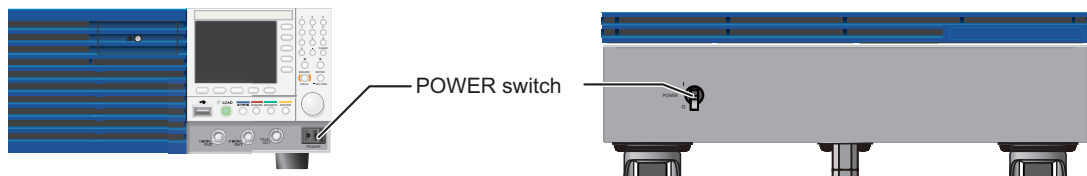

- 1** Check that the power cord is connected properly.
- 2** Check that nothing is connected to the DC INPUT terminals.
- 3** Turn the **POWER switch ( I )** on.  
The power turns on, and the display lights.

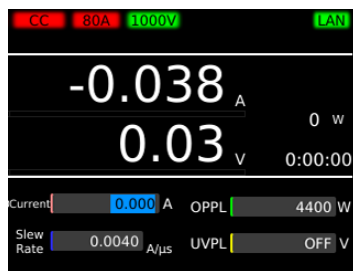

By factory default, the panel settings immediately before the POWER switch is turned off are saved. When you turn the power on, the product starts in the same state as it was in the last time it was turned off. (However, the load setting is always Load Off.)

The panel setting state at startup can be changed ([p. 127](#)).

### NOTE

- If you notice strange sounds, unusual odors, fire, or smoke around or from inside the product, flip the POWER switch off, or remove the power cord plug from the outlet.
- The POWER switch of the PLZ12005WH2 and PLZ20005WH2 is a circuit breaker type. If the AC power line is not compatible with the input rating of this product or if there is an error in the internal power supply of this product, the POWER switch is activated as a power supply circuit breaker.

## Turning the power off

---

Turn the POWER switch off (O).

---

**⚠ CAUTION**

If you want to turn the POWER switch back on, wait at least 5 seconds after the fan stops. Repeatedly turning the POWER switch on and off at short intervals will shorten the service life of the POWER switch and the internal input fuse.

---

# Connecting to the DUT

---

Connect the DUT to the DC INPUT terminal. The PLZ1005WH2, PLZ2005WH2, and PLZ4005WH2 have DC INPUT terminals on both the rear panel and front panel. The specifications of the product are for the rear-panel DC INPUT terminals.

For information on selecting load cables, refer to “Selecting the Load Cables” (p. 160) in the “Appendix”. Large current load cables are available as options.

---

## WARNING

**Risk of electric shock.**

- Do not touch DC INPUT terminals when the output is turned on.
- Do not approach or place non-isolated objects within 5 cm of the load cables when the output is turned on.
- (PLZ1005WH2, PLZ2005WH2, and PLZ4005WH2 only) The front-panel DC INPUT terminals are connected internally to the rear-panel DC INPUT terminals. The voltage applied to the terminal on one side appears directly at the terminal on the other side.

## CAUTION

**Risk of damage.**

- Do not connect the DUT to the DC INPUT terminals while the product's load is turned on.
- Do not invert the polarity when connecting. An overcurrent might flow regardless of whether the load is turned on.
- (PLZ1005WH2, PLZ2005WH2, and PLZ4005WH2 only) Do not connect electronic loads to the front-panel DC INPUT terminals and the rear-panel DC INPUT terminals at the same time.

**Risk of overheating.**

- Attach crimping terminals to the cables, and use the supplied screws to connect the cables.
-

## When connecting to the rear-panel DC INPUT terminals

Connect the DUT to the rear-panel DC INPUT terminals.

**⚠ WARNING Risk of electric shock.**

- Be sure to attach the included cover for the rear-panel DC INPUT terminals.
- (PLZ1005WH2, PLZ2005WH2, and PLZ4005WH2 only) Attach the protection plate or included cover for the front-panel DC INPUT terminals also to the front-panel DC INPUT terminals. The voltage applied to the rear-panel DC INPUT terminals appears at the front-panel DC INPUT terminals.

**1 Turn off the load.**

**2 Turn off the DUT output.**

**3 Attach crimping terminals to the load cables.**

The rear-panel DC INPUT terminals have bolt holes for connecting the load cables. Attach the appropriate crimping terminals to the cables.

Model	Bolt size	Tightening torque
PLZ1005WH2, PLZ2005WH2, PLZ4005WH2	M10	22.46 N•m
PLZ12005WH2, PLZ20005WH2	M12	33.06 N•m

**4 Connect the load cables to the rear-panel DC INPUT terminals using the screw set for rear-panel DC INPUT terminals.**

- PLZ1005WH2, PLZ2005WH2, PLZ4005WH2

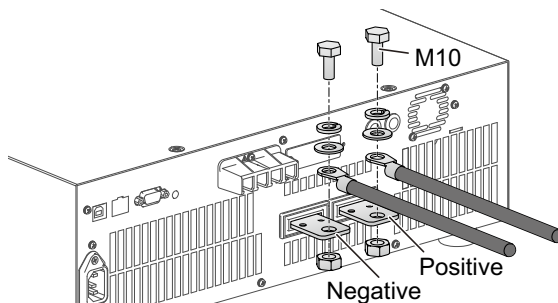

- PLZ12005WH2, PLZ20005WH2

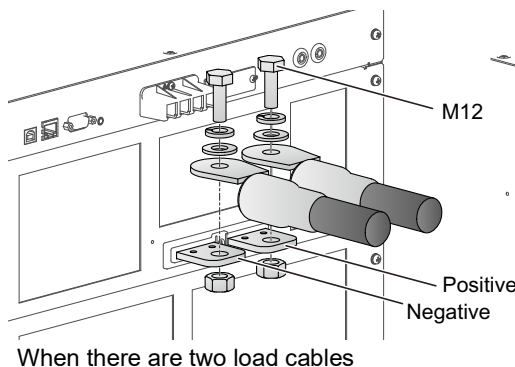

When there are two load cables

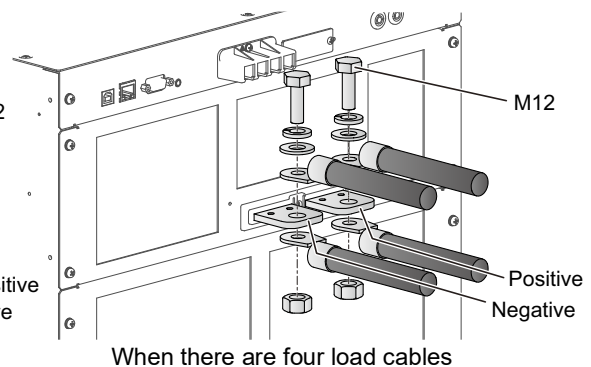

When there are four load cables

- 5** Align the bottom half of the included rear-panel DC INPUT terminal cover to the cables connected to the rear-panel DC INPUT terminals.

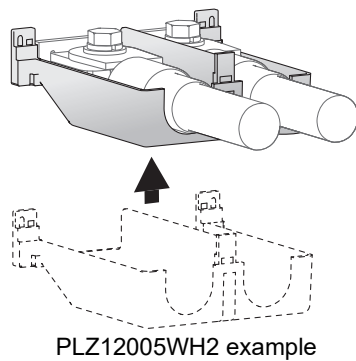

- 6** Align the top half of the cover to the bottom half.  
Align the tabs of the cover according to the load cable diameter.

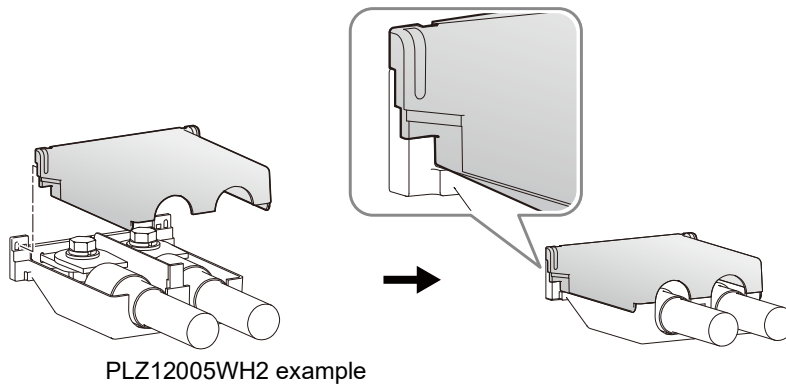

- 7** Push the cover against the panel, and fasten it with the included rear-panel DC INPUT terminal cover screws.

Make sure that the screws are securely fastened.

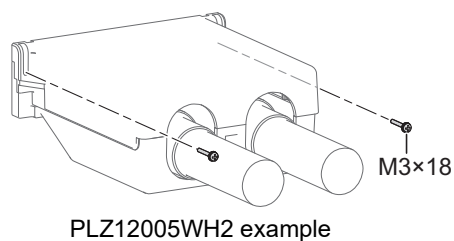

- 8** Connect the load cables to the output terminals of the DUT.

Be careful to match the polarities of the rear-panel DC INPUT terminals with those of the DUT terminals during connection.

Use the shortest cables possible to connect the product and DUT, and twist the cables. If the cables are too thick to be twisted, bring the rear-panel DC INPUT terminal's positive and negative terminal cables close together and make them parallel.

This completes the connections.

## When connecting to the front-panel DC INPUT terminals

The PLZ1005WH2, PLZ2005WH2, and PLZ4005WH2 have DC INPUT terminals also on the front panel. The front-panel DC INPUT terminals enable you to easily connect the product and DUT. The specifications of the product are for the rear-panel DC INPUT terminals. The front-panel DC INPUT terminals may not meet the specifications.

### **⚠ WARNING** Risk of electric shock.

- **Attach insulation caps to the crimping terminals.**
- **Be sure to attach the included cover for the front-panel DC INPUT terminals.**
- **Be sure to attach the included cover for the rear-panel DC INPUT terminals also to the rear-panel DC INPUT terminals. The voltage applied to the front-panel DC INPUT terminals appears at the rear-panel DC INPUT terminals.**

### **NOTE**

The rated current value of the front-panel DC INPUT terminals is 30 A. When a current of 30 A or more flows to the front-panel DC INPUT terminals, an alarm occurs and the load turns off.

**1** Turn off the load.

**2** Turn off the DUT output.

**3** Attach crimping terminals to the load cables.

Cables with a nominal cross-sectional area up to 8 mm<sup>2</sup> can be used. Attach crimping terminals that are designed for M5 screws.

**4** Remove the protection plate from the front-panel DC INPUT terminals.

Keep the removed protection plate and screws in a safe place.

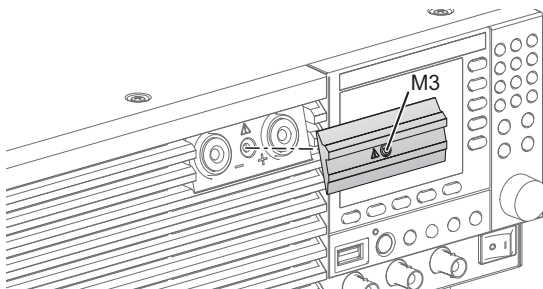

**5** Pass the load cables through the included front-panel DC INPUT terminal cover.

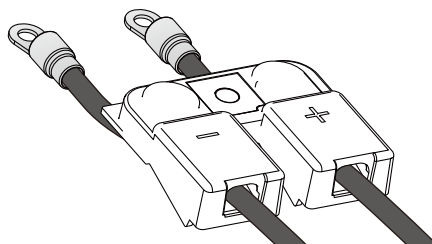



## 6 Connect the load cables to the front-panel DC INPUT terminals using the screws for the front-panel DC INPUT terminals.

The tightening torque is 2.61 N·m.

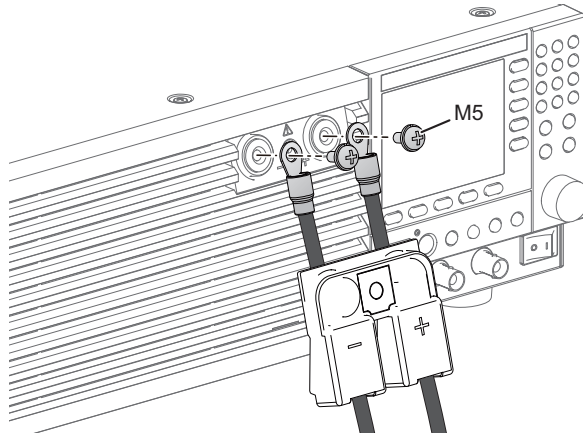

## 7 Attach the front-panel DC INPUT terminal cover.

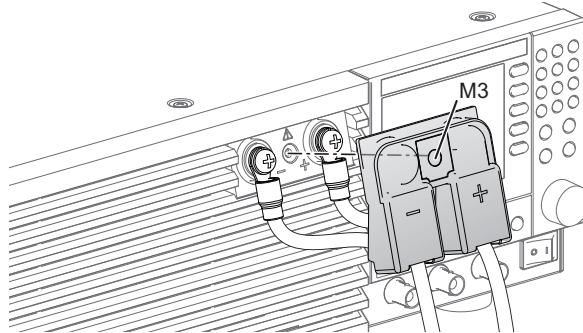

## 8 Connect the load cables to the output terminals of the DUT.

Connect the positive (+) polarity of the front-panel DC INPUT terminals to the positive (+) polarity of the DUT, and the negative (-) polarity of the front-panel DC INPUT terminals to the negative (-) polarity of the DUT. Use the shortest cables possible to connect the product and DUT, and twist the cables.

This completes the connections.

## Notes regarding DC INPUT terminals

### Do not apply overvoltage to the DC INPUT terminals

**CAUTION** Risk of damage. Do not apply a voltage that exceeds 1000 Vdc to the DC INPUT terminals.

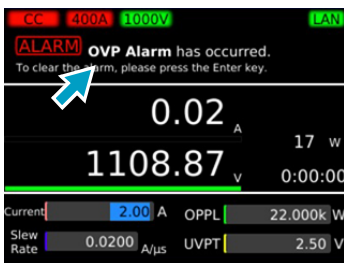
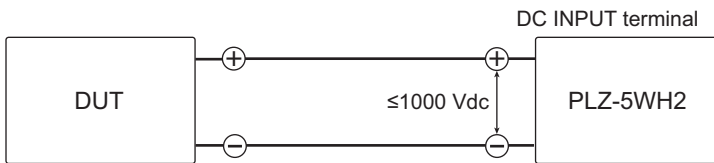

If a voltage exceeding 1100 V is applied to the DC INPUT terminals, a beeping sound is generated and an OVP alarm (overvoltage detection) appears.

If this happens, immediately lower the voltage of the DUT.

### Match the wiring polarity with that of the DUT

**CAUTION** Risk of damage. Be careful to match the polarities of the DC INPUT terminals with those of the DUT during connection.

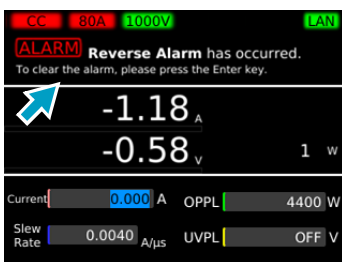
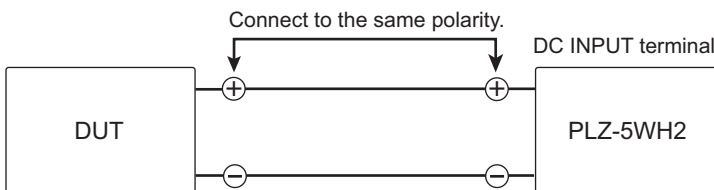

If a reverse voltage of -5 V or higher is applied or a reverse current (approximately -1 % of the rating) flows, a beeping sound is generated and a reverse alarm (reverse-connection detection) appears.

If this happens, immediately shut off the DUT output.

# Basic Functions

## Panel Operations

This chapter explains the front panel operations in general.

### Switching the display

There are two display modes: function display and main display. The function display shows functions that can be executed on each screen. The main display shows measured values with large numbers.

Pressing a menu key shows the function display of the corresponding menu screen. Pressing the same menu key again on the function display switches the display to the main display.

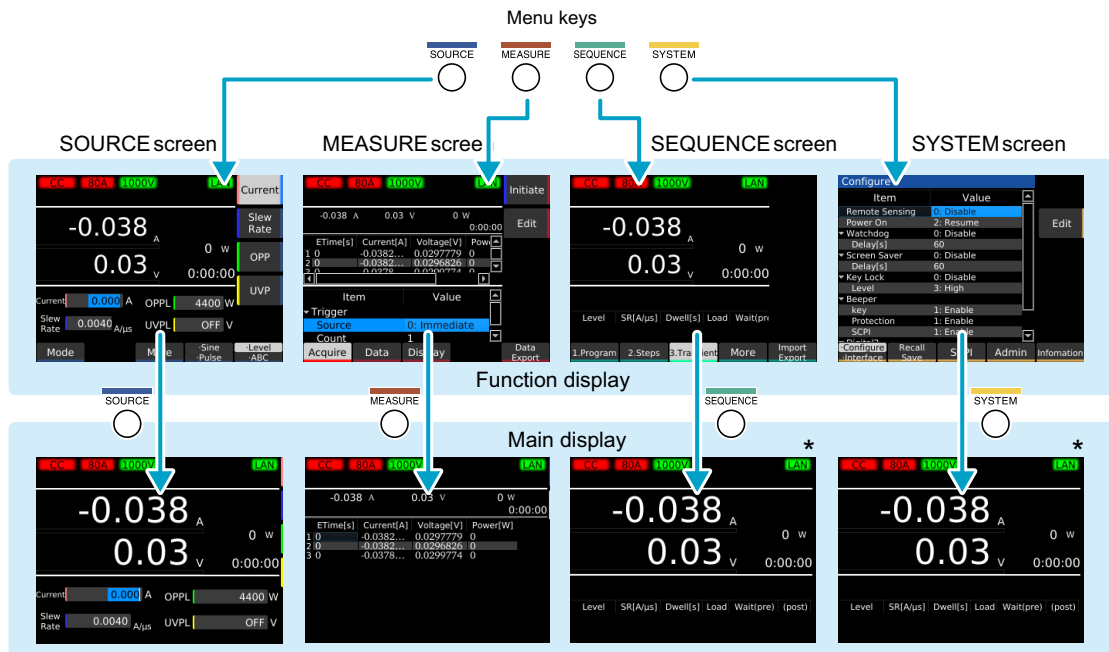

\* On the SEQUENCE screen, the main display of the screen that appears when 3.Transient is pressed appears. On the SYSTEM screen, the main display of the menu screen displayed previously appears.

Menu keys	Main functions			
SOURCE	Operation mode and load setting	Resistance range	Slew rate	Pulse
	Sine	Alarm	Response speed	Soft start
	Cutoff	ABC preset memories	Load on/off synchronization	External control
MEASURE	Measurement recording	Measurement recording trigger	Integrated data recording, display	Measurement recording synchronization
	Sequence function	Program configuration	Step configuration	Sequence execution
SEQUENCE	Sequence synchronization	Sequence start trigger		
	Remote sensing	Setup memory	System configuration	Interface configuration
	SCPI error display	Date/time setting	Factory default settings	Resets settings
SYSTEM	Display of device information	Updating		

## Using the function keys

On the function display (p. 25), the available functions are shown in the function area and sub-function area. You can execute or select the functions by pressing the corresponding function key or sub-function key. The selected function is shown with a light gray background.

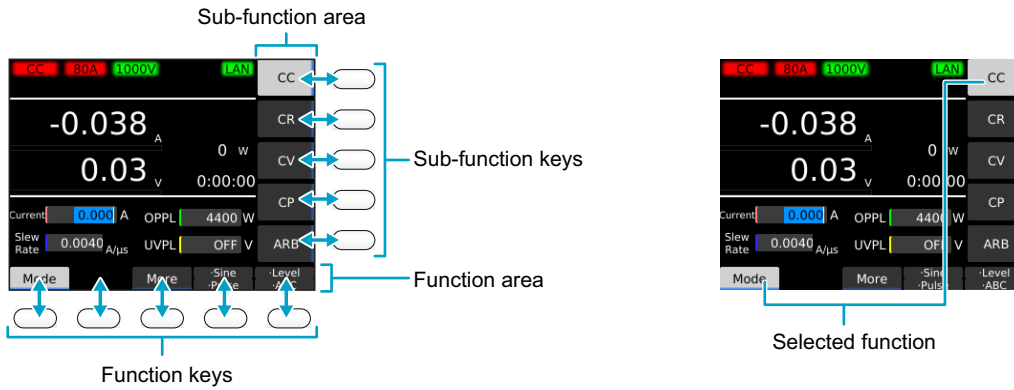

### When several functions are shown

If several functions that can be used with a single function key are shown, you can toggle between the functions by repeatedly pressing the function key.

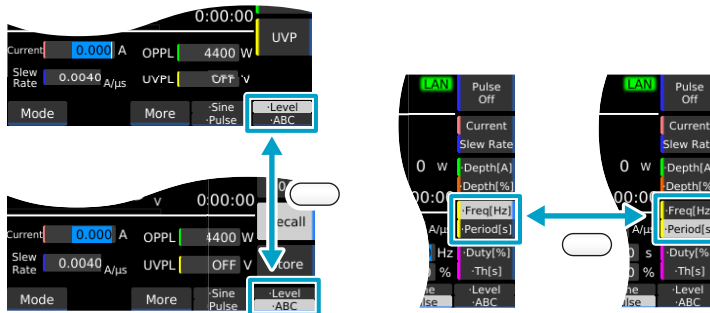

### Key names

In this document, individual function keys and sub-function keys are distinguished by indicating the function names shown in the function area or sub-function area as the key names. If there are several functions shown, the name of the function to use is indicated as the key name.

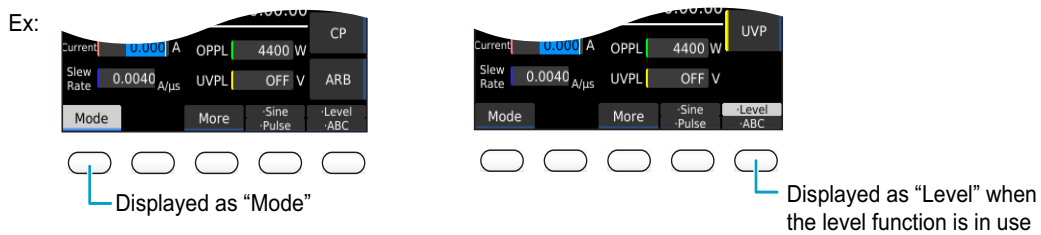

## Operation example (Selection of constant resistance mode)

**1** Press SOURCE > Mode > CR.

In the above step example, press the buttons in the following order.

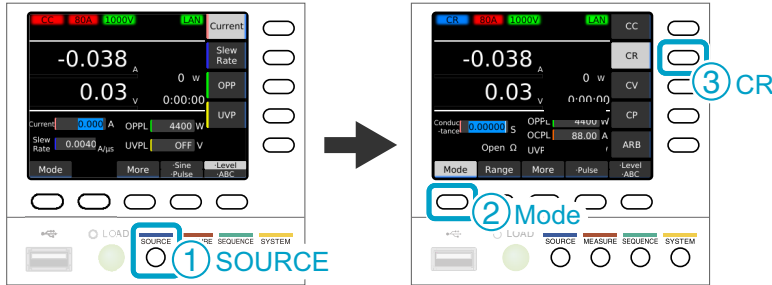

## Identification using color markers

### Menu identification

Color markers corresponding to the colors of menu keys are shown at the bottom edge of the function area and at the right edge of the sub-function area. The color marker makes it possible to identify the present menu screen.

Example: SOURCE screen (function display)

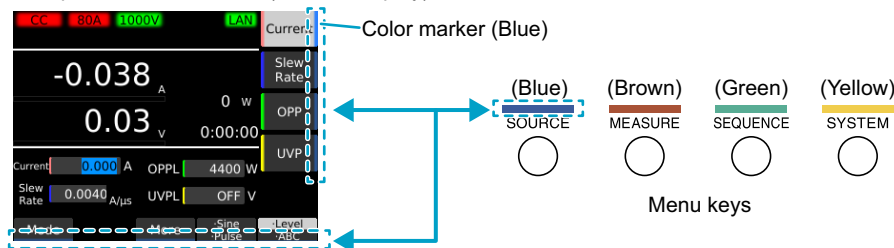

### Identification of settings and sub-function keys

On the SOURCE screen, the input area of each setting and the corresponding sub-function area are assigned a specific color. Even when the sub-function area is hidden while the main display is shown, the color is displayed at the right edge of the screen. With the main screen shown, you can enter settings by pressing the function key with the color corresponding to the input area.

Example: SOURCE screen (when applying current)

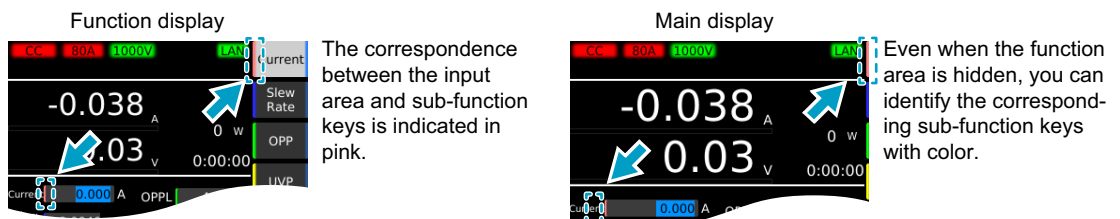

There are no input area color markers on the MEASURE or SEQUENCE screen. When the main display is shown, colors appear at the positions of the available sub-function keys.

## Inputting numbers and characters

You can enter numbers and characters in input areas from the front panel or external keyboard. Numeric input and character input switch automatically according to the input area.

If numbers or characters are selected in an input area, they can be changed. If only a cursor is shown in an input area, you can enter characters or numbers at the cursor position.

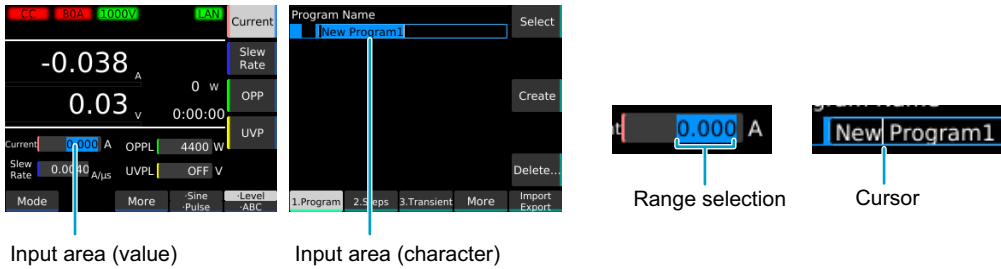

### Entering from the front panel

Purpose	Operation	Description
Numeric input <sup>1</sup>	Numeric keypad	You can enter numbers and a decimal point. Following input, press the ENTER key to confirm the value.
	Rotary knob	You can enter numbers. Turn clockwise to increase the value and counterclockwise to decrease. The value is confirmed immediately upon input.
Character input	Numeric keypad	You can enter numbers and dots.
	Rotary knob	Turn clockwise to enter characters in the following order: space, uppercase letters, lowercase letters, numbers, and symbols. Turn counterclockwise to enter character in reverse order. To enter the next character, press the ← or → key to move the cursor. The character entered immediately before is confirmed when you press the ← or → key.
Cursor movement	←/→ keys	Changes the number of digits or input position.
Delete	CLEAR key	Deletes the number or character on the left of the cursor or the selected range.
Cancel	ESCAPE key	Cancels numeric/character input.

1. Numeric input such as current and voltage has input limits based on the setting range and other conditions. You cannot enter numbers outside the input range. For details on the setting ranges, see “Specifications” (p. 145).

### Entering from an external keyboard

You can enter numbers/characters if you connect a keyboard to the USB port on the front panel. Use the arrow keys to move the cursor, the Backspace and Delete key to delete numbers and characters, the Escape key to cancel input, the Enter key to confirm, and the Tab key to move between input items. Connect the keyboard while the product is turned on.

The types of keyboards that you can use are 101-key and 104-key keyboards.

## Changing values

To change a selected value (e.g., load value), use the numeric keypad or rotary knob. If you enter a value with the numeric keypad, following input, press the ENTER key to confirm the value.



Use the numeric keypad or the rotary knob to change the value.

On screens in which “Edit” is shown in the sub-function area, use the rotary knob to select the item you want to change, and then press the Edit key or a numeric key to start changing the value. Procedures using the Edit key are provided in this document.

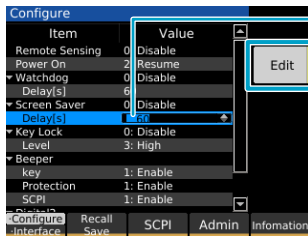

Pressing Edit or a numeric key makes it possible to edit the value.

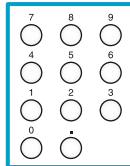

When changing a setting, if there are multiple items you can choose from, select a number in front of the item name using the numeric keypad, or select the item using the rotary knob. Procedures using the rotary knob are provided in this document.

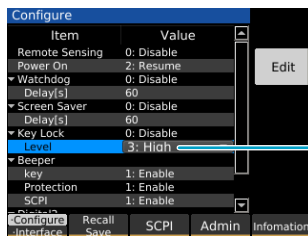

If there are multiple items when settings are being changed, use the numeric keypad or the rotary knob to select the item.

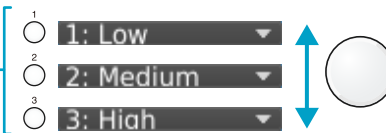

To confirm a value you entered, press the Edit or ENTER key. Procedures using the ENTER key are provided in this document.

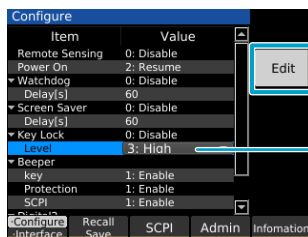

Use Edit or ENTER to confirm the value.



# Load On/Off

The phrase “load on” refers to a condition in which a current is running through the product. “Turning the load on” refers to the operation of running a current through the product. Conversely, “load off” refers to a condition in which a current is not running through the product. “Turning the load off” refers to the operation of stopping a current from running through the product. You can turn the load on and off using the LOAD key.

## 1 Press LOAD.

The value switches between load on and load off each time you press LOAD.

In the load on state, the load on LED lights.

In the load off state, the load on LED turns off.

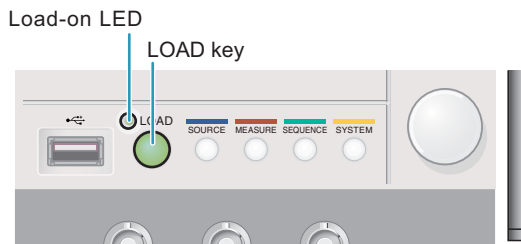

### ■ Controlling load on/load off externally

Load on/load off can be controlled using an external signal (p. 115).

### ■ Gradually raising the input current

In constant current (CC) mode, you can set to slowly raise the input current. (Soft start) (p. 66).

### ■ Turning off the load after a specified time elapses

When performing battery or capacitor discharge tests, it is convenient to use the function that turns off the load when a specified time elapses (cutoff function) (p. 70).

### ■ Turning off the load by specifying conditions

The load can be turned off when the voltage drop, the integrated current, or the integrated power reaches the specified value (cutoff function) (p. 70).

# Setting the Operation Mode

The product has the following five operation modes. Mode switching can be done only while the load is off.

Constant current (CC) mode	When a current value is specified, the current is kept at that value even when the voltage changes.
Constant resistance (CR) mode	When a conductance value is specified, the product sinks current proportional to the voltage variation by using the value as a proportionality constant.
Constant voltage (CV) mode	When a voltage value is specified, the product runs the current so that the voltage is kept at that value.
Constant power (CP) mode	When a power value is specified, the product runs the current so that the power is kept at that value.
Arbitrary I-V characteristics (ARB) mode	The desired load characteristics can be set by specifying multiple arbitrary voltage values and current values as I-V characteristics.

## Selecting the operation mode

You can set the operation mode only when the load is off.

### 1 Press SOURCE > Mode.

The operation mode is shown in the sub-function area.

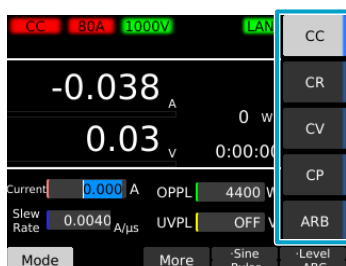

### 2 Use the sub-function keys to select the operation mode.

“CC” (red), “CR” (blue), “CV” (green), “CP” (orange), or “ARB” (gray) appears in the upper left of the display depending on the selected operation mode.

This completes the setting.

## Setting the current in CC mode

In CC mode, the current is kept constant even when the voltage changes.  
For details, see “Operation of the constant current (CC) mode” (p. 167).

- 1 Set the operation mode to CC mode (p. 31).
- 2 Press Level > Current.



- 3 Use the numeric keypad or the rotary knob to enter the current value.  
This completes the setting. The current value can be changed even while the load is turned on.

### Adding the +CV mode (a function compatible with the PLZ-5W series)

If you want to set the +CV mode, which is available on the PLZ-5W series (PLZ205W, PLZ405W, PLZ1205W), on this product, use an SCPI command. The +CV mode can be specified in CC mode or CR mode. If you set the +CV mode, CC+CV or CR+CV appears in the “selected operation mode” area (p. 13) in the upper left of the display.

This function is available for maintaining compatibility with the SCPI commands of the PLZ-5W series. For details on SCPI commands, see the Communication Interface Manual on the included CD-ROM.

## Setting the conductance in CR mode

In CR mode, the product sinks current proportional to the voltage variation. The displayed resistance is a value converted from the conductance. An appropriate SI prefix (k: kilo, m: milli) is displayed according to the converted resistance, and up to three decimal digits are displayed (conductance [S] = 1/resistance [ $\Omega$ ]). For details, see "Operation in constant resistance (CR) mode" (p. 168).

- 1 Switch to CR mode (p. 31).
- 2 Press Level > Conductance.

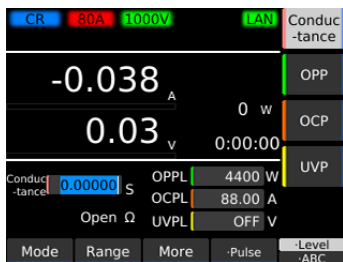

- 3 Use the numeric keypad or the rotary knob to enter the conductance value.

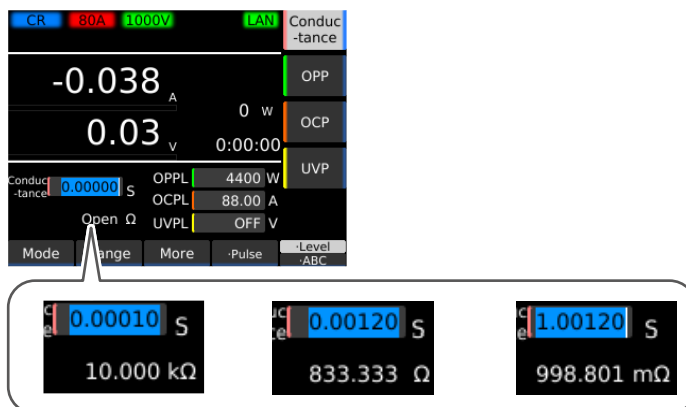

Resistances are displayed with k for kilo or m for milli.  
Up to three decimal places are displayed.

The conductance value can be changed even while the load is turned on.  
This completes the setting.

## Adding the +CV mode (a function compatible with the PLZ-5W series)

If you want to set the +CV mode, which is available on the PLZ-5W series (PLZ205W, PLZ405W, PLZ1205W), on this product, use an SCPI command. The +CV mode can be specified in CC mode or CR mode. If you set the +CV mode, CC+CV or CR+CV appears in the "selected operation mode" area (p. 13) in the upper left of the display.

This function is available for maintaining compatibility with the SCPI commands of the PLZ-5W series. For details on SCPI commands, see the Communication Interface Manual on the included CD-ROM.

## Setting the resistance range of CR mode

In CR mode, you can select H or L for the resistance range. The resistance range is used to set the conductance with the appropriate resolution. The current range is fixed. You can set the resistance range when the load is off.

**1** Switch to CR mode (p. 31).

**2** Press SOURCE > Range.

**3** Set the resistance range to H or L.

The H range is used for conductance whose current variation is large relative to the voltage variation. Otherwise, the L range is used. When the L range is used, the current range display changes from red to pink.

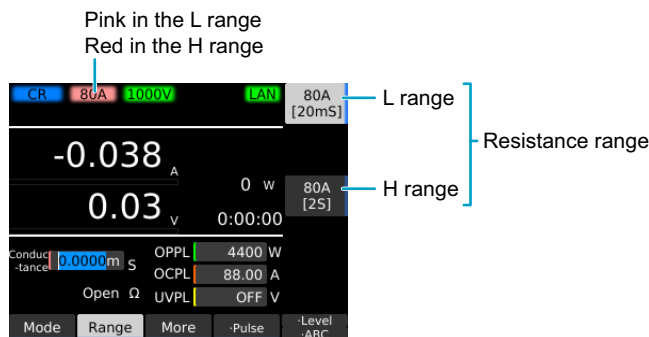

PLZ20005WH2 example

Resistance range		PLZ1005WH2	PLZ2005WH2	PLZ4005WH2
H range	Setting range	505.00 mS to 0 S	1010.0 mS to 0 S	2020.0 mS to 0 S
	Resolution	0.01 mS	0.02 mS	0.05 mS
L range	Setting range	5.0500 mS to 0 S	10.100 mS to 0 S	20.200 mS to 0 S
	Resolution	0.0001 mS	0.0002 mS	0.0005 mS

Resistance range		PLZ12005WH2	PLZ20005WH2
H range	Setting range	6060.0 mS to 0 S	10.1000 S to 0 S
	Resolution	0.2 mS	0.2 mS
L range	Setting range	60.600 mS to 0 S	101.000 mS to 0 S
	Resolution	0.002 mS	0.002 mS

## Setting the voltage in CV mode

In CV mode, the product runs current so that the voltage at the load input end of the product is constant. For details, see “Constant voltage (CV) mode operation” (p. 171).

**1** Switch to CV mode (p. 31).

**2** Press Level > Voltage.

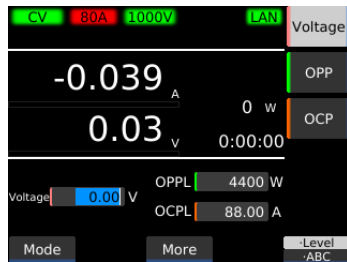

**3** Use the numeric keypad or the rotary knob to enter the voltage value.

This completes the setting. The voltage value can be changed even while the load is turned on.

## Setting the power in CP mode

In CP mode, the product runs current so that the consumed power is constant.  
For details, see “Constant power (CP) mode operation” (p. 170).

**1** Switch to CP mode (p. 31).

**2** Press Level > Power.

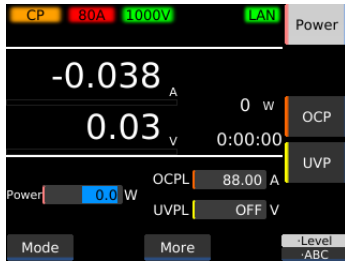

**3** Use the numeric keypad or the rotary knob to enter the power value.

This completes the setting. The power value can be changed even while the load is turned on.



## Setting the I-V characteristics in ARB mode

In ARB mode, arbitrary I-V characteristics can be set by registering multiple I-V characteristic points (pairs of voltage and current values). Three up to 100 points can be registered, and the space between two points is linearly interpolated. The minimum voltage (0.00 V) and current (0.00 A) and the maximum voltage (1010.00 V) are fixed. This mode can be used for simulation of LED loads and the like.

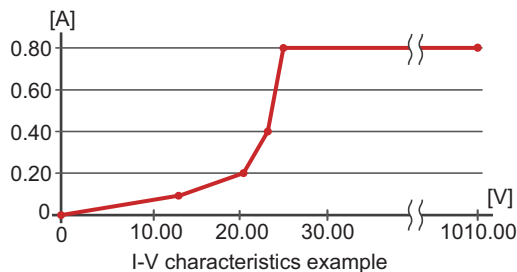

Example of settings (values with an asterisk are fixed)

Voltage [V]	Current [A]
0.00*	0.00*
12.00	0.10
20.50	0.20
23.00	0.40
24.50	0.80
1010.00*	0.80

### Displaying the I-V characteristics editing screen

- 1 Switch to ARB mode (p.31).
- 2 Press Level > Table.  
The I-V characteristics editing screen appears.



### Basic operations on the I-V characteristics editing screen

The left column is voltage, and the right is current. In each row, you can enter a single point of your choice.

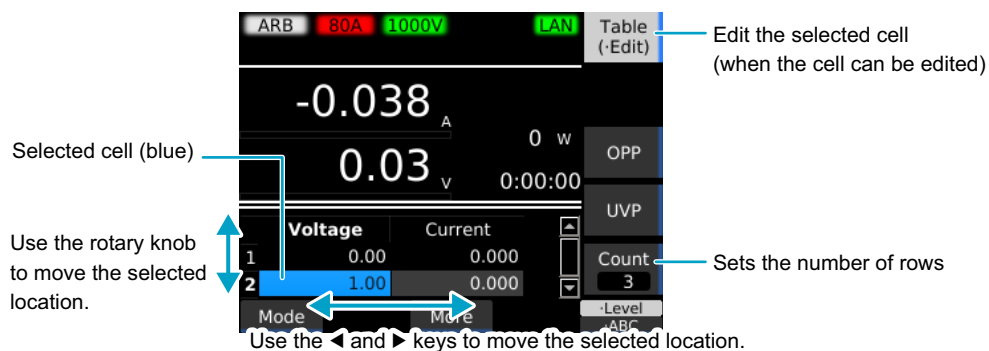

## Setting the number of rows

- You can change the total number of rows (Count 3 to Count 100) using the Count key.
- Increase the number of rows: A copy of the selected row is inserted after the selected row.
- Decrease the number of rows: If you set the total number of rows less than the number of the selected row, the last rows excluding the very last row are deleted.  
If you set the total number of rows larger than the number of the selected row, the selected row and subsequent rows are deleted.

Selecting row 3 and changing Count from 5 to 7

	Voltage	Current
1	0.00	0.000
2	1.00	0.100
3	3.00	0.200
4	3.00	0.300
5	1010.00	0.400

← Two rows are inserted with the copy of row 3.



	Voltage	Current
1	0.00	0.000
2	1.00	0.100
3	2.00	0.200
4	2.00	0.200
5	2.00	0.200
6	3.00	0.300
7	1010.0	0.400

Selecting row 4 and changing Count from 7 to 3

	Voltage	Current
1	0.00	0.000
2	1.00	0.100
3	3.00	0.200
4	3.00	0.300
5	4.00	0.400
6	5.00	0.500
7	1010.0	0.600

Deleted



	Voltage	Current
1	0.00	0.000
2	1.00	0.100
3	1010.0	0.600

Selecting row 4 and changing Count from 7 to 5

	Voltage	Current
1	0.00	0.000
2	1.00	0.100
3	2.00	0.200
4	3.00	0.300
5	4.00	0.400
6	5.00	0.500
7	1010.0	0.600

Deleted



	Voltage	Current
1	0.00	0.000
2	1.00	0.100
3	2.00	0.200
4	5.00	0.500
5	1010.0	0.600

**1** Press Count.

**2** Use the numeric keypad or the rotary knob to enter the number of rows, and then press ENTER.

This completes the setting.

## Setting the frequency

- The voltage (0.00 V) and current (0.000 A) in the first row and the voltage (1010.00 V) in the last row are fixed.
- Set the voltages to linearly increasing values as the line number increases. Same values are considered an increase. You cannot enter a voltage that is less than the previous row or a voltage that is greater than the next row.

**1** Use the rotary knob and ←/→ keys to select a value.

**2** Press Table (•Edit).

You can also press a key on the numeric keypad without pressing Table (• Edit) to start editing.

**3** Use the numeric keys or rotary knob to enter a value, and then press ENTER.

This completes the setting.

## Example: Setting I-V characteristics

You can smoothly set the I-V characteristics by first setting the number of rows and then setting the row with the maximum voltage and proceeding to rows with lower voltages. As an example, let's set the I-V characteristics while referring to the table below.

Example of settings (values with an asterisk are fixed)

Count	Voltage [V]	Current [A]
1	0.00*	0.000*
2	12.00	0.100
3	20.50	0.200
4	23.00	0.400
5	24.50	0.800
6	1010.00*	0.800

### 1 Press Level > Table.

The I-V characteristics editing screen appears.



### ■ Setting the count value

### 2 Press Count.

### 3 Use the numeric keypad or the rotary knob to enter the number of rows (6), and then press ENTER.

The rows are added.

### ■ Setting the current value of row 6

Set only the current value because the voltage is fixed to the maximum voltage (1010.00 V).

### 4 Use the rotary knob and the → key to select the Current column of row 6.

### 5 Press Table (•Edit).

The current value in row 6 becomes editable.

### 6 Use the numeric keypad or the rotary knob to enter the current value “0.8”, and then press ENTER.

The current value in row 6 is set to 0.8 A.

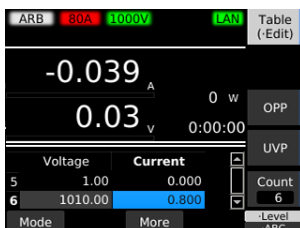

■ Setting the voltage value of row 5

**7** Use the rotary knob and the → key to select the Voltage column of row 5.



**8** Press Table (•Edit).

The voltage value in row 5 becomes editable.

**9** Use the numeric keypad or the rotary knob to enter the voltage value “24.5”, and then press ENTER.

The voltage value in row 5 is set to 24.5 V.

■ Setting the current value of row 5

**10** Use the → key to select the Current column of row 5.

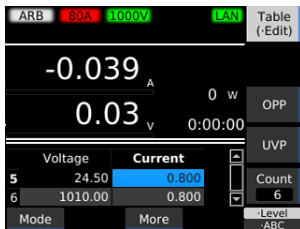

**11** Press Table (•Edit).

The current value in row 5 becomes editable.

**12** Use the numeric keypad or the rotary knob to enter the current value “0.8”, and then press ENTER.

The current value in row 5 is set to 0.8 A.

■ Setting the rest of the rows

**13** In the same manner, set the voltage and current values in rows 4 through 2.

This completes the setting.

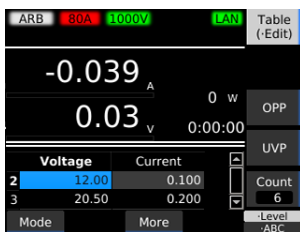

Characteristics display screen (example)

When you press SOURCE to show the main display, the IV characteristics are displayed.

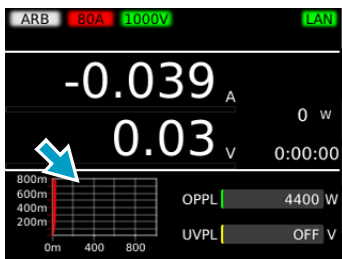

# Setting the Slew Rate

You can set the speed of change when the current is changed.

The slew rate functions in the following cases.

- When the setting is changed to change the current value (including the pulse function).
- When the current value is changed using external control in constant current (CC) mode.
- When the current value is changed while the load is on

## NOTE

- The specified slew rate may not be achieved depending on the load cable inductance. If this happens, reduce the load cable inductance ([p. 162](#)).
- If the load current is small, the specified slew rate may not be achieved ([p. 165](#)).
- If the current changes when the load is turned on, the slew rate may be slower than the setting.

You can set this regardless of whether the load is on or off. This function operates in CC and ARB modes.

**1** Switch to CC or ARB mode ([p. 31](#)).

**2** Press Level > Slew Rate.



**3** Use the numeric keypad or the rotary knob to enter the slew rate value.

The slew rate is set as an amount of current change per unit time. The value is common to rising and falling slopes.

This completes the setting.

# Pulse Function

Pulse refers to the operation of executing two settings repetitively. It is suitable for transient response characteristics testing of large capacity power supplies and batteries. When the pulse operation is in progress, a trigger signal is output from the TRIG OUT connector on the front panel (p. 44). You can set this regardless of whether the load is on or off. This function operates in CC and CR modes.

## Setting the pulse amplitude

The pulse amplitude is set with a value or a percentage of the load value.

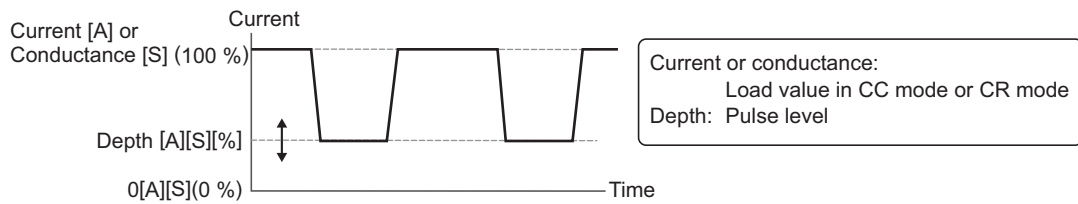

- 1 Switch to CC or CR mode (p. 31).
- 2 Press Pulse > Current or Conductance.



- 3 Use the numeric keypad or the rotary knob to enter the load value (current or conductance).

In CC mode, enter the current value [A], and in CR mode, enter the conductance value [S].

- 4 Press Depth.



- 5 Use the numeric keypad or the rotary knob to enter the pulse amplitude (Depth).

The input switches between numeric input and percentage [%] input every time you press Depth. This completes the setting.

## Setting the pulse interval

Set the frequency or period and then the length of time or duty cycle of the high level (the ratio of the high level in a cycle).

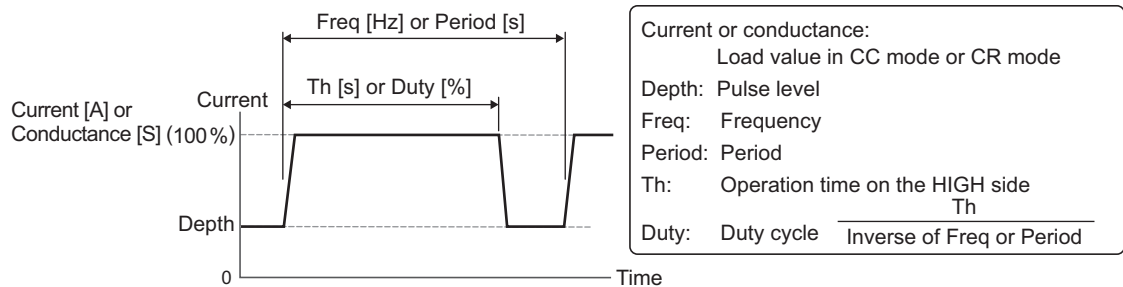

### 1 Press SOURCE > Pulse > Freq or Period.

The input switches between frequency [Hz] input and cycle [s] input every time you press the key.

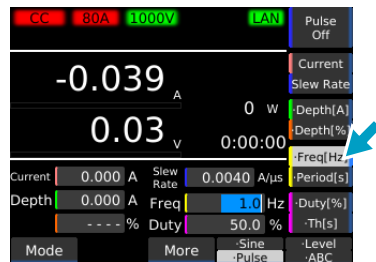

### 2 Use the rotary knob to enter the frequency (FREQ) or period.

You can enter the frequency also using the numeric keypad. If you are using the numeric keypad, you can only enter values within the frequency setting range defined in the specifications and with the setting resolution within that range.

Example: If you try to enter 101 Hz, the "1" in the ones digit will not be accepted.

### 3 Press Duty or Th.

The input switches between duty ratio [%] input and high level time [s] input every time you press the key.

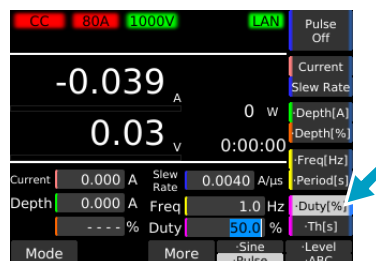

### 4 Use the rotary knob to enter the duty ratio or high level time (Th).

You can enter the duty ratio also using the numeric keypad. The minimum pulse interval is 20  $\mu\text{s}$ . The minimum changeable digit of high level time varies depending on the frequency.

This completes the setting.

## Turning the pulse function on/off

If you want to turn on the pulse function, set the pulse level (p. 42) and pulse interval (p. 43) in advance.

**1** Press SOURCE > Pulse.

**2** Press Pulse On or Pulse Off.

The pulse function toggles between on and off each time you press the key.

When the pulse function is on,  is shown on the display.



## Timing of trigger signal output

When the pulse operation is in progress, a trigger signal is output for 10  $\mu\text{s}$  from the TRIG OUT connector on the front panel when the current amplitude changes from low to high level.

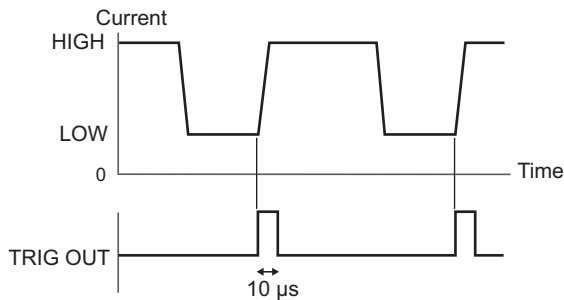



# Sine Function

The sine function varies the current sinusoidally. It is suitable for superposed ripple testing of large capacity power supplies and batteries. When a sine operation is in progress, a trigger signal is output from the TRIG OUT connector on the front panel (p. 47). You can set this regardless of whether the load is on or off. This function operates in CC mode. You cannot set the slew rate.

## Setting the amplitude

Set the center value of the amplitude of the sine wave and the amplitude.

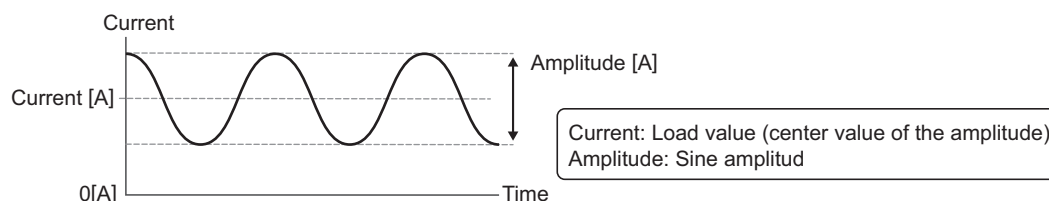

**1** Set the operation mode to CC mode (p. 31).

**2** Press Sine > Current.



**3** Use the numeric keypad or the rotary knob to enter the load value (Current).

The load value becomes the center value of the amplitude.

**4** Press Amplitude.



**5** Use the numeric keypad or the rotary knob to enter the sine amplitude (Amplitude).

The amplitude is a P-P value with the center value at the load value.

This completes the setting.

## Amplitude limitation

When the amplitude is from 0 A to the rated current, setting the center value of the amplitude to Current 1 causes a portion of the upper side of the sine wave to exceed the rated current, so the amplitude is limited by the rated current. Likewise, setting the center value of the amplitude to Current 2 causes a portion of the lower side of the sine wave to become less than 0 A, so the amplitude is limited by 0 A.

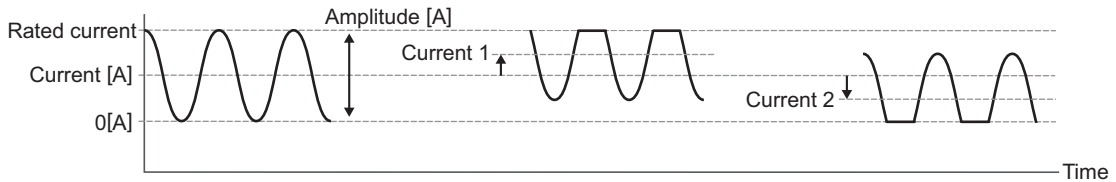

## Setting the frequency

Set the frequency of the sine amplitude set with Amplitude.

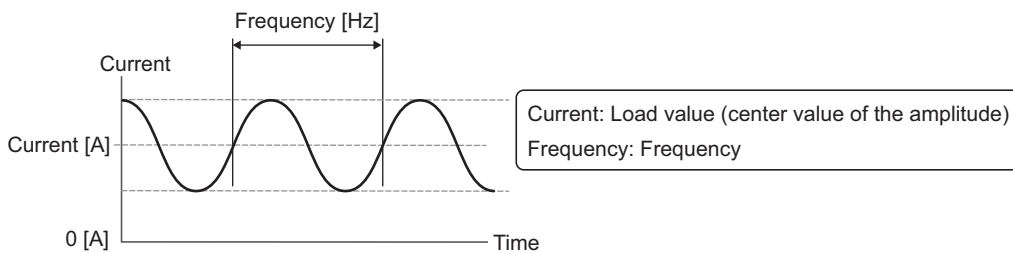

### 1 Press SOURCE > Sine > Frequency.



### 2 Use the numeric keypad or the rotary knob to enter the frequency.

If you are using the numeric keypad, you can only enter values within the frequency setting range defined in the specifications and with the setting resolution within that range.

Example: If you try to enter 101 Hz, the “1” in the ones digit will not be accepted.

This completes the setting.

## Turning the sine function on/off

If you want to turn on the sine function, set the sine amplitude (p. 42) and frequency (p. 43) in advance.

**1** Set the operation mode to CC mode (p. 31).

**2** Press Sine.

**3** Press Sine On or Sine Off.

The sine function switches on and off each time you press the key.

When the sine function is on,  is shown on the display.



## Trigger signal timing

When a sine operation is in progress, a trigger signal is output for 10  $\mu$ s from the TRIG OUT connector on the front panel when the current passes through the center value of the amplitude (Current) on the rising edge (sine wave phase at 0 degrees).

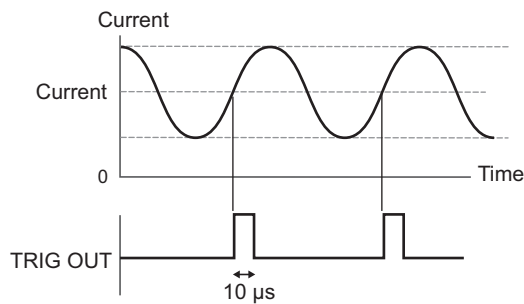

# Alarm Function

This function detects anomalies and protects the DUT.

## Alarm types and operation

There are two types of alarm based on urgency level: alarm 1 (high urgency) and alarm 2 (low urgency).

### Alarm 1 (high urgency)

This alarm detects anomalies and automatically turns off the load. The operating conditions of this alarm are fixed.

When alarm 1 occurs, immediately remove the cause(s) of the alarm.

Name	Display	Activation condition and handling	Activation
Overvoltage detection	OVP Alarm	A voltage that is equal to or exceeds 110 % of the rated voltage was applied to the DC INPUT terminals. If this happens, immediately lower the voltage of the DUT.	Load off
Reverse-connection detection	Reverse Alarm	Approximately -1 % of the rated current flowed through the DC INPUT terminals. If this happens, immediately shut off the DUT output.	Load off
Overheat detection, overcurrent detection of the front-panel DC INPUT terminals	OTP/Front Alarm	The temperature of the internal devices exceeds the standard. Check whether the air inlet on the front panel and the air outlet on the rear panel are being obstructed.	Load off
		A current of 30 A or more flowed through the front-panel DC INPUT terminals. Decrease the current, or use the rear-panel DC INPUT terminals.	Load off
Alarm input detection	External Alarm	A signal between 1.5 V and 0 V is applied to ALARM INPUT (pin No. 6) of the EXT CONT connector. First clear the signal input to the EXT CONT connector, then clear the product alarm.	Load off
Parallel operation anomaly detection	See the reference.	An anomaly occurred during parallel operation ( <a href="#">p. 125</a> ).	Load off

## Alarm 2 (low urgency)

This alarm protects the DUT. The operating conditions of this alarm can be set freely within a given range.

Name	Display	Mode	Activation condition	Activation
Overcurrent protection (OCP)	OCP Alarm	CR	Current at or exceeding the OCP setting (0 % to 110 % of rated current) flows (p. 50).	Load off or limit
		CV		
		CP		
Overpower protection (OPP)	OPP Alarm	CC	Power at or exceeding the OPP setting (0 % to 110 % of rated current) is applied (p. 51).	Load off or limit
		CR		
		CV		
		ARB		
Undervoltage protection (UVP) <sup>1</sup>	UVP Alarm	CC	The voltage becomes equal to or less than the UVP setting (0 V to 1000 V) (p. 52).	Load off, limit, or activation off
		CR		
		CP		
		ARB		
Watchdog Protection (WDP)	Watchdog Alarm	All	SCPI communication is not performed for a length of time that is equal to or exceeds the watchdog protection setting (1 s to 3600 s) (p. 53).	Load off

1. UVP can be set to off.

## Operating range

The following figure shows the alarm operating range. For details on the operating area of each operation mode, see “Operating Area” (p. 166).

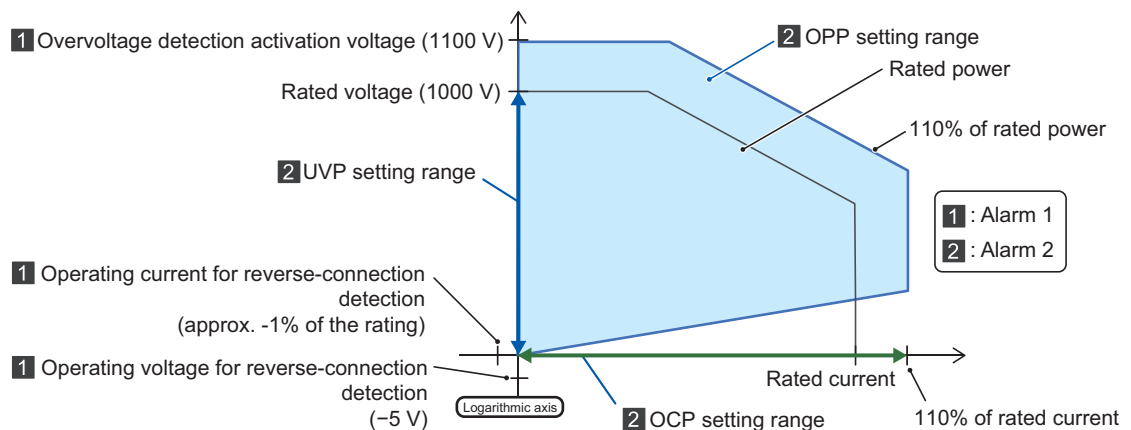

### NOTE

- The detection points of OCP, OPP, and UVP are the DC INPUT terminals of the product. However, when the remote sensing function (p. 67) is used, the detection points are the connection points (sensing points).
- The detection points for overvoltage detection and reverse-connection detection are the DC INPUT terminals of the product.

## Setting overcurrent protection (OCP)

This function either puts a limit on the current (OCPL) or turns off the load of the product (OCPT) when a current that is equal to or exceeds the set value is running through the product. You can set the overcurrent protection setting and the action taken when an alarm occurs.

You can set this function when the load is off. This function operates in CR, CV, and CP modes.

**1** Switch to CR, CV, or CP mode (p. 31).

**2** Press Level > OCP.



**3** Use the numeric keypad or the rotary knob to enter the current value.

**4** Press Action and select the action taken when an alarm occurs.



Each time you press the key, the parameters displayed under Action change.

Parameter	Description
Trip	Turns the load off. The setting display changes to OCPT.
Limit	Limits the current so as not to exceed the set value. The setting display changes to OCPL.

This completes the setting.

## Setting overpower protection (OPP)

This function either puts a limit on the power (OPPL) or turns off the load of the product (OPPT) when a current that is equal to or exceeds the set value is applied to the product. You can set the overpower protection setting and the action taken when an alarm occurs.

You can set this function when the load is off. This function operates in modes other than CP mode.

**1** Switch to CC, CR, CV, or ARB mode (p. 31).

**2** Press Level > OPP.



**3** Use the numeric keypad or the rotary knob to enter the power value.

**4** Press Action and select the action taken when an alarm occurs.



Each time you press the key, the parameters displayed under Action change.

Parameter	Description
Trip	Turns the load off. The setting display changes to OPPT.
Limit	Limits the power so as not to exceed the set value. The setting display changes to OPPL.

This completes the setting.

## Setting undervoltage protection (UVP)

This function limits the current (UVPL) or turns off the load (UVPT) when the voltage applied to the product becomes equal to or less than the UVP setting. You can also turn UVP off. You can set this regardless of whether the load is on or off. This function operates in modes other than CV mode.

- 1 Switch to CC, CR, CP, or ARB mode (p. 31).
- 2 Press Level > UVP.



- 3 Use the numeric keypad or the rotary knob to enter the voltage value.  
To turn this off, turn the rotary knob counterclockwise to select OFF.

- 4 Press Action and select the action taken when an alarm occurs.



Each time you press the key, the parameters displayed under Action change.

Parameter	Description
Trip	Turns the load off. The setting display changes to UVPT.
Limit	Limits the voltage so as not to become equal to or less than the set value. The setting display changes to UVPL.

This completes the setting.

### NOTE

If the +CV mode is added with an SCPI command (p. 32), the UVP value is changed to the set voltage of the CV mode. If +CV mode is set to on, UVP limit operation is enabled. Otherwise, UVP TRIP operation is enabled.



## Setting watchdog protection (WDP)

This function turns off the load of the product when SCPI communication is performed for a length of time that is equal to or exceeds the WDP setting.

### 1 Press SYSTEM.

The Configure screen appears.

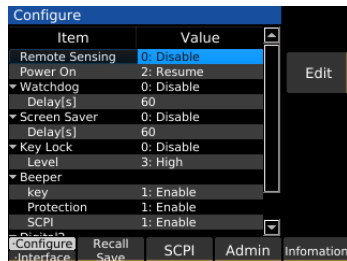

If the Configure screen does not appear, press Configure.

### 2 Use the rotary knob to select Delay under Watchdog, and then press Edit.

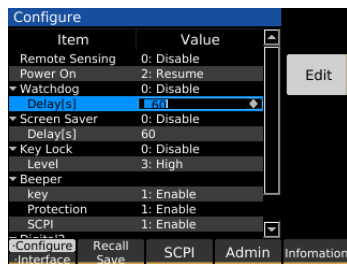

### 3 Use the numeric keypad or the rotary knob to enter the duration of time until the watchdog times out, and then press ENTER.

This sets the WDP value.

### 4 Use the rotary knob to select Watchdog, and then press Edit.

### 5 Use the rotary knob to select Enable or Disable, and then press ENTER.

This completes the setting.

## When an alarm occurs

An alarm message appears in the message area of the display. If the action taken when an alarm occurs is set to Limit, the operation mode display changes to the alarm name.



Example when OVP occurs

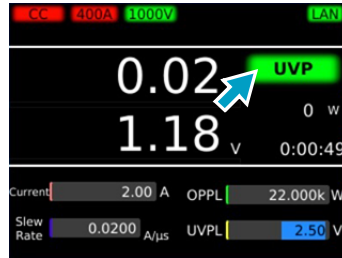

Example when UVPL occurs

There are the following status outputs to the EXT CONT connector.

- When overvoltage detection (OVP), reverse-connection detection, overheat detection, alarm input detection, or parallel operation anomaly detection is activated: ALARM1 (terminal 14) switches ON
- When OCP, OPP, UVP or WDP is activated: ALARM2 (pin 15) switches ON

## Clearing an alarm

**1** Remove the cause of the alarm.

**2** Press ENTER.

The alarm is cleared.

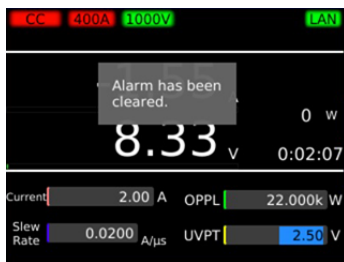

**NOTE**

- If the cause of the alarm remains, the alarm will occur again.
- You can also clear the alarm with an external control signal ([p. 117](#)).

# Recording Measurements

This product shows the most recent measurements (current, voltage, power) on the display. Measurements are recorded in the internal memory (data logging function).

By setting measurement recording conditions (p. 56), you can control the timing that measurements are recorded. The recording timing of measurements can be synchronized on synchronized products (p. 85).

## Starting measurement recording

### 1 Press MEASURE > Acquire.

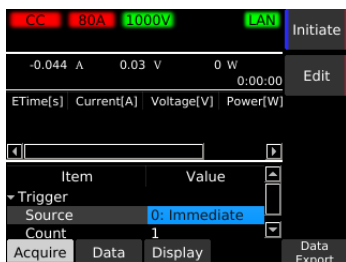

### 2 Press the Initiate key.

Measurement recording starts. While recording is in progress,  is displayed in the upper right of the display.

## Setting recording conditions

You can set the following measurement recording conditions.

Condition	Value	Description
Trigger	–	Set the measurement recording timing and the number of times to record measurements.
Source	–	Event (trigger source) that defines the measurement recording condition. Recording starts after the Initiate key is pressed and a trigger is received.
	Immediate	Pressing Initiate applies a trigger immediately.
	BUS	Applies a trigger when a *TRG command is received from a PC or when the *TRG key on the front panel is pressed.
	DIGITAL2 <sup>1</sup>	Applies a trigger when a signal is received at pin 13 of the EXT CONT connector.
	MSync	The trigger application timing is synced between PLZ-5WH2 that are synchronized (p. 85).
	TALink	Applies a trigger when a step is executed if Generate is set to TALink in the sequence step settings (p. 97).
	Load Off	Applies a trigger when the load is turned off.
Count	1 to 65536	The number of times to recorded measurements.
Delay	0 $\mu$ s to 100 s (resolution: 10 $\mu$ s)	The delay time from trigger application until measurement recording.
Interval	Disable/Enable	Sets whether to insert an interval between recordings when Count is 2 or higher.
Interval Time	10 $\mu$ s to 3600 s (resolution: 10 $\mu$ s)	Recording interval time when Interval is set to Enable.
Sense Aperture	10 $\mu$ s to 1 s (resolution: 10 $\mu$ s)	Time period of each recording. The average over the time period is recorded.

1. Only when Direction of Digital 2 is set to Input (p. 131).

## Recording condition setting examples

### ■ Example 1:

- Source: Immediate
- Interval: Disable
- Count: 3

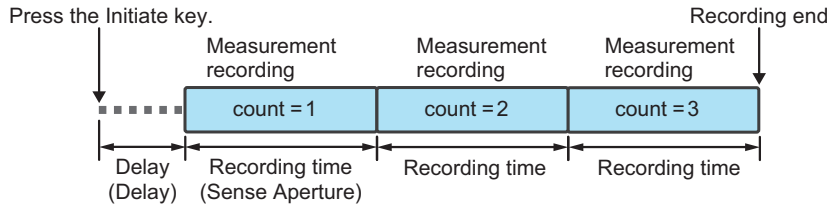

### ■ Example 2:

- Source: BUS, DIGITAL2, TALink, MSync, or Loadoff
- Interval: Disable
- Count: 3

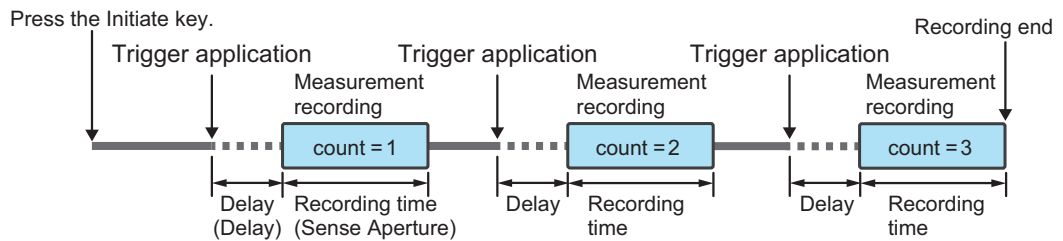

### ■ Example 3:

- Source: Immediate
- Interval: Enable
- Count: 3

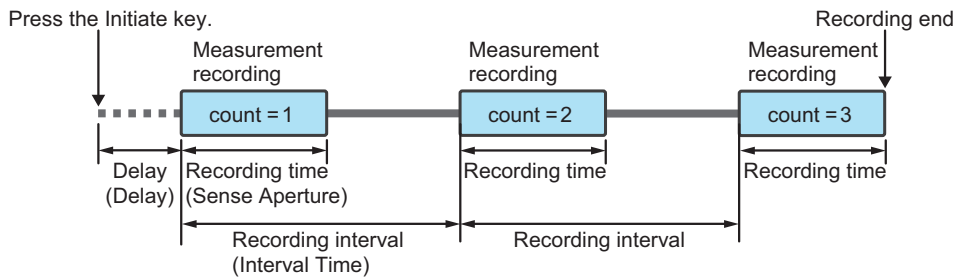

### Measurement recording flowchart

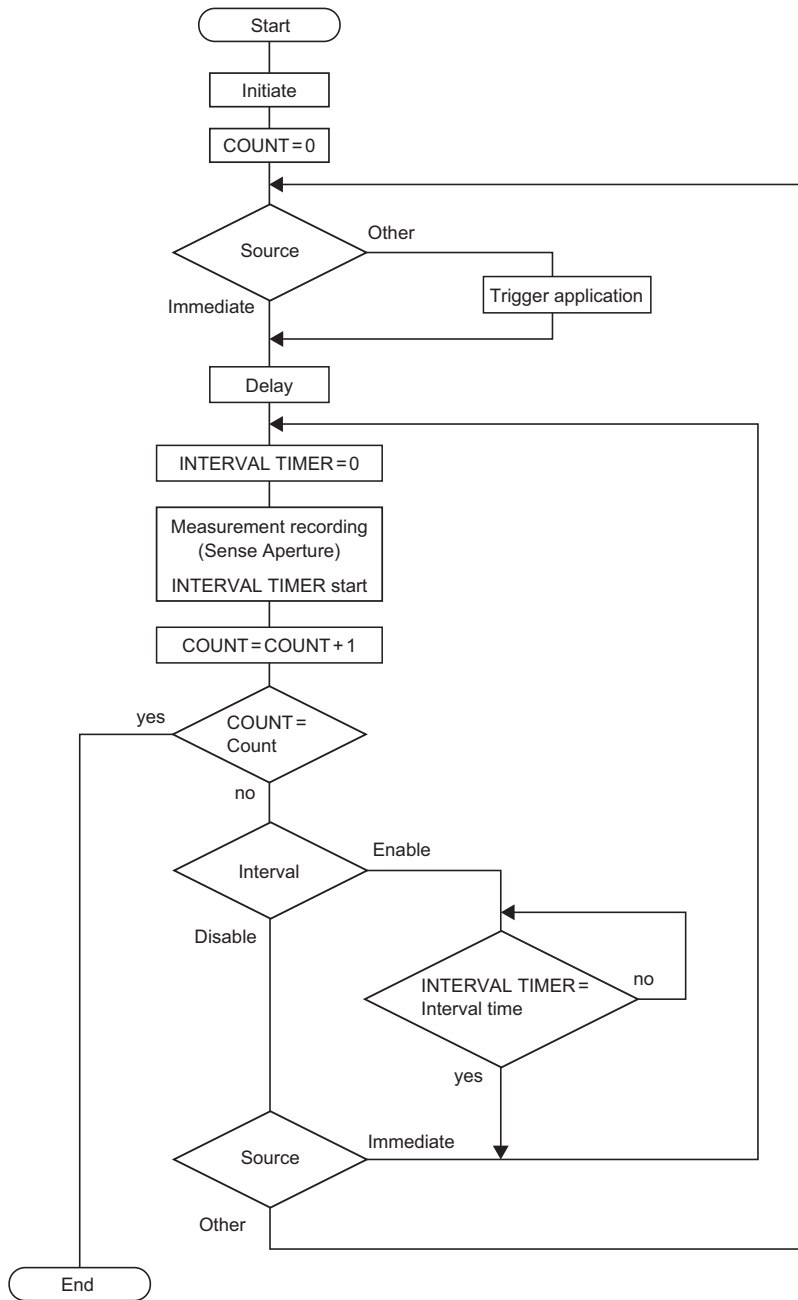

## Setting recording conditions

- 1 Press MEASURE > Acquire.
- 2 Use the rotary knob to select a measurement recording condition (p. 56), and then press Edit.

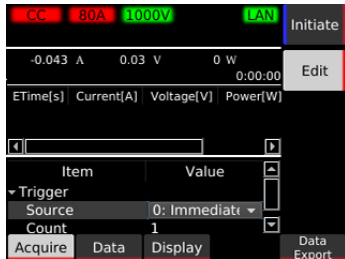

- 3 Use the numeric keys or rotary knob to enter a value, and then press ENTER.  
Repeat Step 2 and Step 3 to set the recording conditions.  
This completes the setting.

## Aborting a measurement recording

- 1 Press Abort while measurement is in progress.

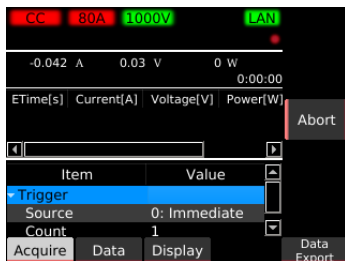

Measurement recording is aborted.

## Displaying the recorded measurement

Measured data can be shown in a table or chart.

### Table display

- 1 Press MEASURE > Display > Table.

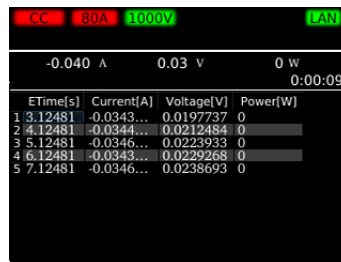
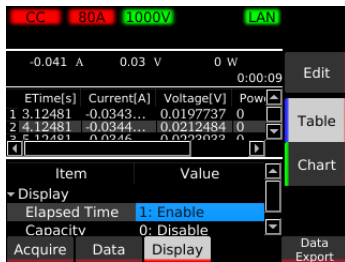

You can perform the following operations on the main display.

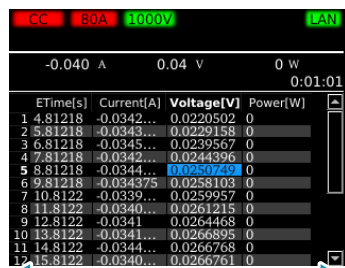

### Chart display

- 1 Press MEASURE > Display > Chart.

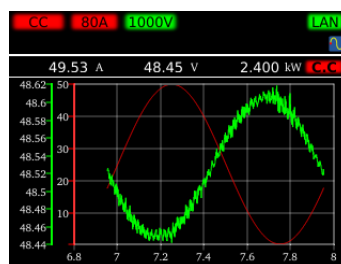
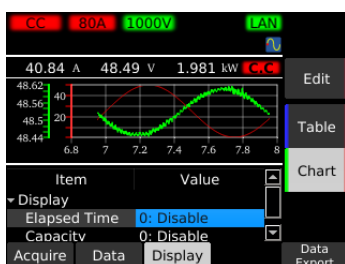

The horizontal and vertical scales are set automatically according to the measurement.



# Recording Integrated Data

## Recording integrated current, integrated power, and elapsed time

Integrated current (Capacity Ah), integrated power (Energy Wh), and elapsed time (s) are called integrated data. You can set the recording period and the reset method of integrated data as in the table below.

In the factory default conditions, Integral Gate is set to Load On and Reset is set to Auto.

Parameter	Value	Description
Integral Gate	–	Set the integrated data recording period.
	None	Integrated data recording is started/stopped manually.
	Load On	Recording is started/stopped automatically in synchronization with load on/load off. Or, recording is started or stopped manually.
	Program Run	Recording is started/stopped automatically in synchronization with sequence execution start/stop. Or, recording is started or stopped manually.
Reset	–	Selects the integrated data reset method. If the product is restarted, integrated data is reset.
	Manual	Integrated data is reset when the Reset key is pressed.
	Auto	Integrated data is automatically reset before the start of recordings. Or, integrated data is reset when the Reset key is pressed.

Example: Integral Gate is set to Load On, and UVP is set

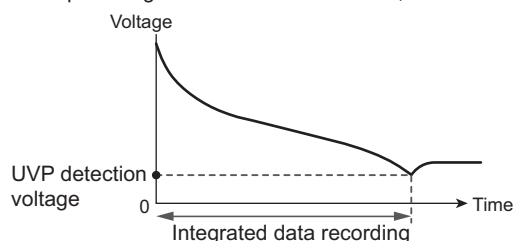

## Setting the recording period and reset method of integrated data

- 1 Press **MEASURE > Data**.
- 2 Use the rotary knob to select the items, and then press **Edit**.

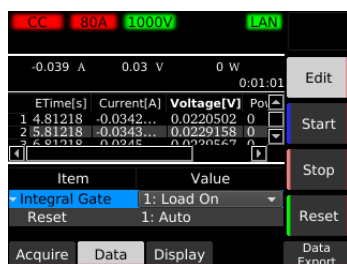

- 3 Use the rotary knob to select the value, and then press **ENTER**.  
Repeat Step 2 and Step 3 to set the recording period and reset method.  
This completes the setting.

## Recording integrated data manually

### 1 Press MEASURE > Data.

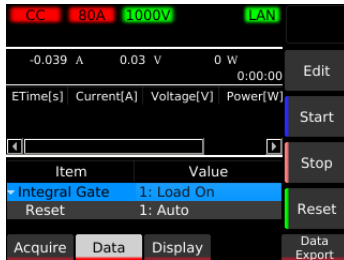

### 2 Press Start.

Integrated data recording starts.

### 3 Press Stop.

Integrated data recording stops.

## Resetting integrated data

### 1 Press MEASURE > Data.

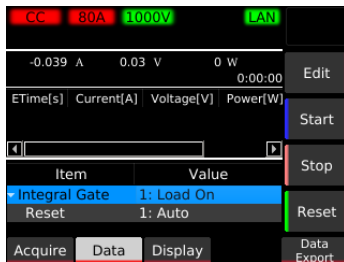

### 2 Press Reset.

This resets the integrated data.

## Showing or hiding integrated data

You can show or hide integrated data. This is useful for example for battery discharge tests. By factory default, the integrated current and integrated power are not shown.

- 1 Press **MEASURE > Display**.
- 2 Use the rotary knob to select the parameter, and then press **Edit**.

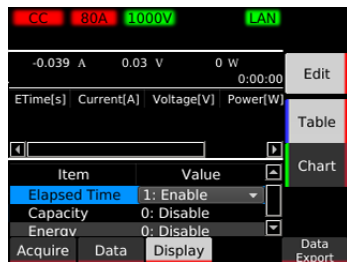

Parameter	Value	Description
Display	Elapsed Time	Enable/Disable
	Capacity	Enable/Disable
	Energy	Enable/Disable

### NOTE

There is a  $\pm 1$  second error between the elapsed time recording (p. 61) and elapsed time display.

- 3 Use the rotary knob to select **Enable (show) or disable (hide)**, and then press **ENTER**. This completes the setting.

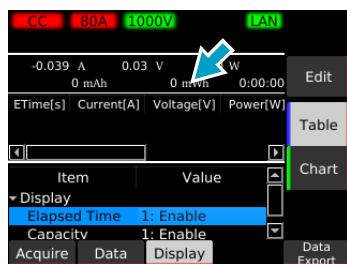

Display example of integrated current, integrated power, and elapsed time

# Saving Measurement Data

Recorded measurement values (p. 55) and integrated data (p. 61) can be stored in CSV format to a USB memory device.

- 1 Press MEASURE > Data Export.**
- 2 Insert a USB memory device into the USB port on the front panel.**  
“sdxx” (xx changes depending on the USB memory device) appears.

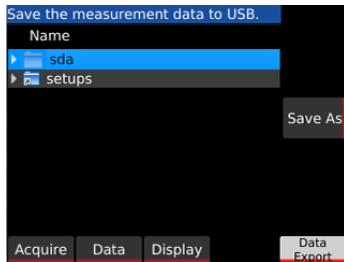

- 3 Use the rotary knob to select the USB memory directory.**  
Select the directory and press → to open the lower level. Press ← to close the lower level.  
The top directory, sdxx, is the root directory of the USB memory device.
- 4 Press Save As.**  
The CSV data is saved.
- 5 Use the numeric keypad or the rotary knob to enter a file name of your choice, and then press ENTER.**

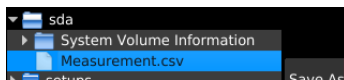

The measurement data is saved with the specified file name.

## CSV data

Example: Format of the CSV data saved to a USB memory device

ETime[s]	Current[A]	Voltage[V]	Power[W]	Capacity[Ah]	Energy[Wh]
30.92355	0.556787	4.305881	2.397457	0.018838	0.087071
31.02355	0.679384	4.305859	2.925332	0.018857	0.087152
31.12355	1.823047	4.305092	7.848385	0.018908	0.08737

# Advanced Functions

## Changing the Response Speed

Set the response speed for CV, CR, or ARB mode according to the DUT's conditions and application. In CV or CR mode, the factory default setting is "Normal". You can make the response speed faster by setting "Fast". In ARB mode, the factory default setting is "500  $\mu$ s".

Parameter	Description	
Response	Voltage	Set the response speed for CV mode. Normal, Fast
	Conductance	Set the response speed for CR mode. Normal, Fast
	ARB	Set the response speed for ARB mode. The value is the filter response time. Select OFF for no filter. OFF, 500 $\mu$ s, 1 ms, 2 ms, 5 ms, 10 ms, 20 ms, 50 ms, 100 ms

**NOTE** When the response speed is set to Fast, the operation may become unstable if the load cable is long or has a large loop. If this happens, decrease the response speed.

- 1 Switch to CV, CR, or ARB mode (p. 31).
- 2 Press More.
- 3 Use the rotary knob to select Voltage, Conductance, or ARB under Response, and then press Edit.



- 4 Use the rotary knob to select the value, and then press ENTER.  
This completes the setting.

# Soft Start

Soft start is a function that controls the rise time of the load current.

Soft start functions only when all the following conditions are met.

- The rise time of the soft start has been set.
- Load on state in constant current (CC) mode.
- There is an input that is equal to or exceeds 1.5 V, from the state where there is no input to the DC INPUT terminals.

If the load current rises sharply, the DUT output may become unstable or the DUT's overcurrent protection circuit may be activated. In such situations, it is possible to raise the load current slowly only when the product is started.

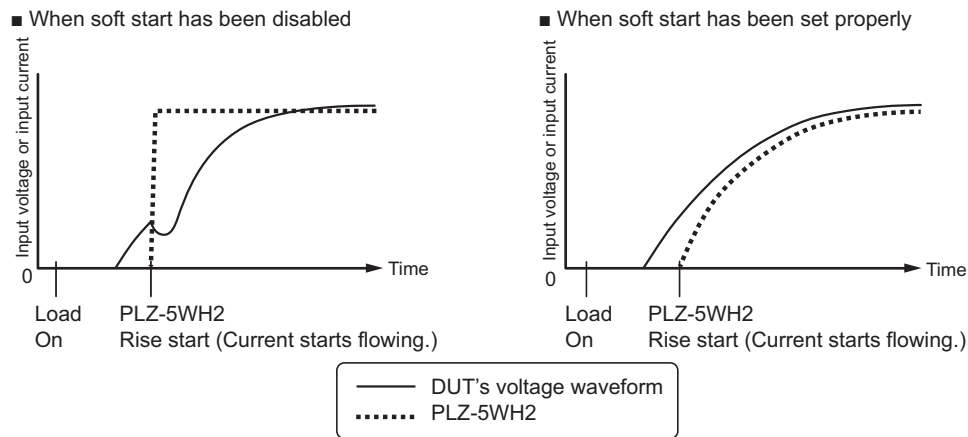

- 1 Press **SOURCE > More**.
- 2 Use the rotary knob to select **Soft Start**, and then press **Edit**.



- 3 Use the rotary knob to select the soft start time, and then press **ENTER**.  
 Selecting Off disables soft start.  
 This completes the setting.

# Remote Sensing

You can change a voltage measurement point from a DC INPUT terminal to an arbitrary sensing point. By setting sensing points at the DUT end, influences such as voltage drops caused by the resistance of the load cables can be reduced, and the load current can be stabilized.

To use remote sensing, connect the sensing cables to the product's SENSING terminals (+S, -S) and the DUT terminals, and enable remote sensing in the SYSTEM menu.

## Connecting cables to the safety terminal adapters

When connecting sensing cables to the SENSING terminals, use the included safety terminal adapters (TL41).

Use sensing cables with a withstanding voltage of at least 1000 V. Unlike with the load cables, there is no need to consider the allowable current. Cable diameter with a nominal cross-sectional area between  $0.75 \text{ mm}^2$  and  $2.5 \text{ mm}^2$  (AWG18 and AWG14) is compatible with the safety terminal adapter.

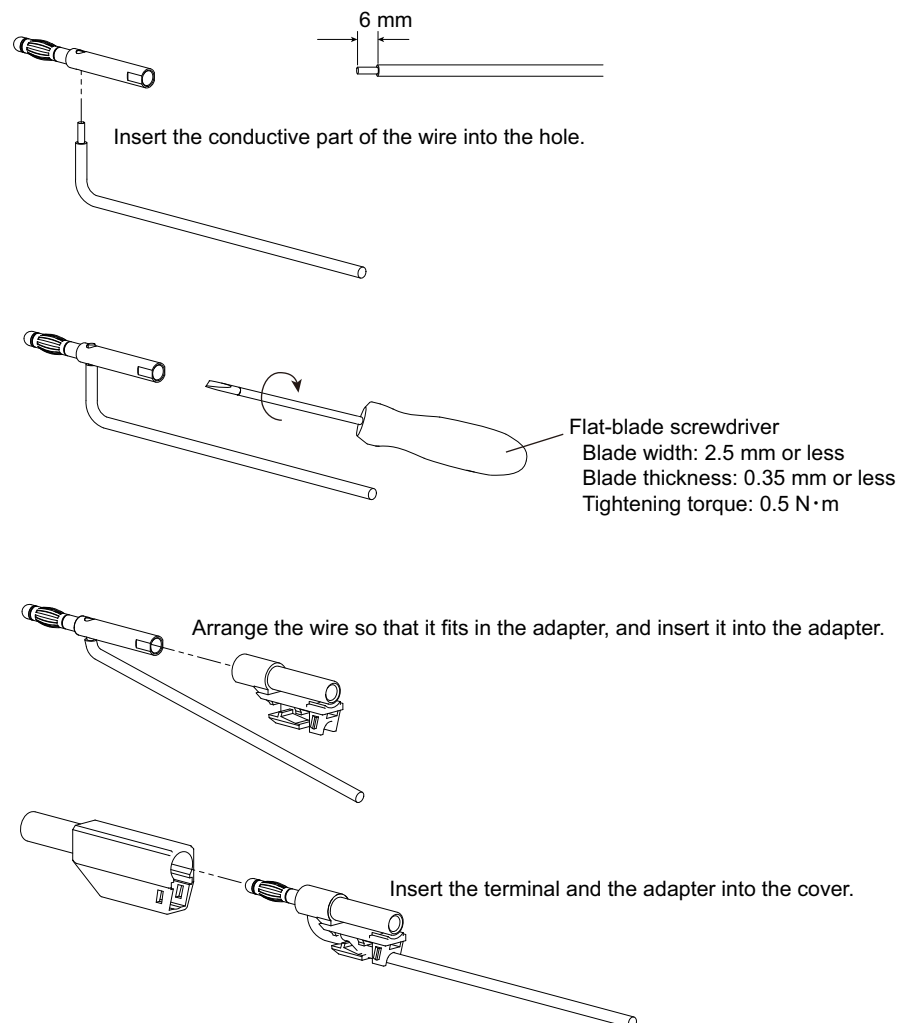

## Connecting the sensing cables

Connect the included safety terminal adapter, TL41, to the sensing cables in advance. (p. 67)

- ⚠ CAUTION**
- Risk of damage to the internal circuitry. Never connect cables to the SENSING terminals while the POWER switch is turned on.
  - If the remote sensing cables come loose while remote sensing is in use, the product and DUT may be damaged. Be sure to connect the cables securely.

- 1** Turning the POWER switch off (○)
- 2** Connect the sensing cables to the product.

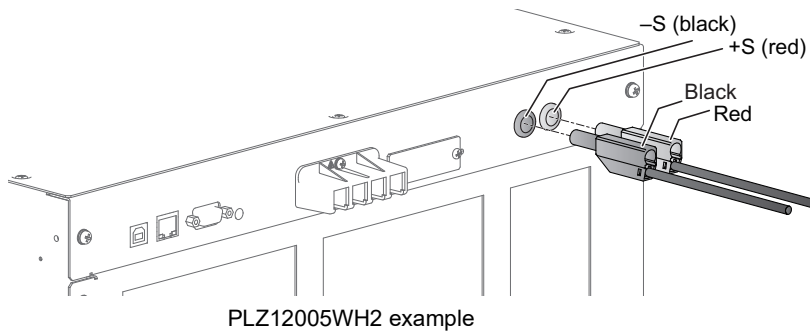

- 3** Connect the sensing cables to the DUT.

When connecting, match the polarities of the SENSING terminals with those of the DUT terminals.

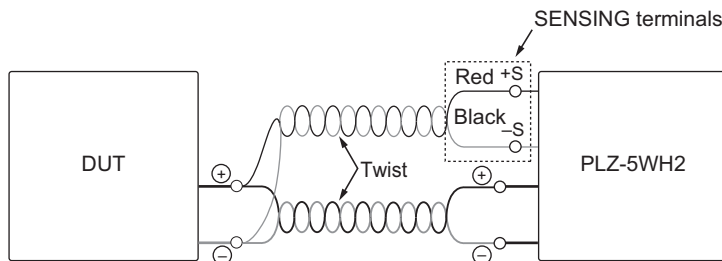

This completes the connections.



## Enabling or disabling remote sensing

After connecting the sensing cables to the SENSING terminals, enable remote sensing. Remote sensing can be set when the load is turned off and sequence operation is stopped.

### 1 Press SYSTEM.

If the Configure screen does not appear, press Configure.

### 2 Use the rotary knob to select Remote Sensing, and then press Edit.

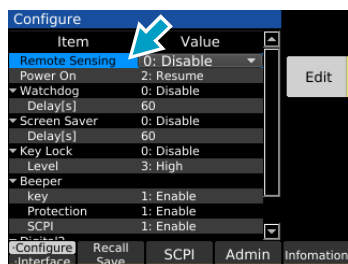

### 3 Use the rotary knob to select Enable or Disable, and then press ENTER.

If you select Enable,  appears in the upper right of the display other than the SYSTEM screen. This completes the setting.

# Cutoff Function

This function turns the load off when the elapsed time from load-on, the voltage drop, the integrated current, or the integrated power reaches the specified value. These four functions are collectively referred to as cutoff.

## Setting the cutoff activation condition

Multiple cutoffs can be specified simultaneously. If any of the cutoff items is enabled, an icon (  ) appears in the top area of the display. If a cutoff is activated, the icon corresponding to the item that caused it appears in the top area of the display (p. 73).

Cutoff item	Description
Elapsed time	The load turns off when the elapsed time value reaches the specified value.
Voltage drop <sup>1</sup>	The load turns off when the voltmeter value reaches the specified value.
Integrated current	The load turns off when the ampere-hour meter value reaches the specified value.
Integrated power	The load turns off when the watt-hour meter value reaches the specified value.

1. The same operation is performed using Trip (UVPT) of the constant voltage protection (UVP), but whereas when an UVPT is activated, an alarm occurs, in the case of cutoff, an alarm does not occur.

- 1 Press SOURCE > More.
- 2 Use the rotary knob to select State under the item you want to set, and then press Edit.
  - For elapsed time, select State under ETime.
  - For voltage drop, select State under Voltage.
  - For integrated current, select State under Capacity.
  - For integrated power, select State under Energy.



- 3 Use the rotary knob to set Enable or Disable, and then press ENTER.

- 4** If set to Enable, use the rotary knob to select Level, and then press Edit.



- 5** Use the numeric keypad or the rotary knob to enter the value for activating the cut-off, and then press ENTER.

Parameter	Setting range	Resolution
Elapsed time	0 s to 3600000 s (1000 h 0 min 0 s)	1 s
Voltage drop	0.00 V to 1000.00 V	0.02 V
Integrated current	0.000 mAh to 70.000 kAh (PLZ1005WH2)	0.001 mAh (0.000 mAh to 1000.000 mAh)
	0.000 mAh to 140.000 kAh (PLZ2005WH2)	0.001 Ah (1.001 Ah to 1000.000 Ah)
	0.000 mAh to 280.000 kAh (PLZ4005WH2)	0.001 kAh (1.001 kAh to 1000.000 kAh)
	0.000 mAh to 800.000 kAh (PLZ12005WH2)	0.001 MAh (1.001 MAh to 1.400 MAh)
	0.000 mAh to 1400.000 kAh (PLZ20005WH2)	
Integrated power	0.000 Wh to 40.000 MWh (PLZ1005WH2)	0.001 Wh (0.000 Wh to 1000.000 Wh)
	0.000 Wh to 80.000 MWh (PLZ2005WH2)	0.001 kWh (1.001 kWh to 1000.000 kWh)
	0.000 Wh to 160.000 MWh (PLZ4005WH2)	0.001 MWh (1.001 MWh to 800.000 MWh)
	0.000 Wh to 500.000 MWh (PLZ12005WH2)	
	0.000 Wh to 800.000 MWh (PLZ20005WH2)	

This completes the setting.

## Cutoff operation

Cutoff is activated based on integrated data (p. 61). The operation necessary before and after the cutoff varies depending on the integrated data recording setting.

### ■ Relationship between the cutoff activation condition, integrated data setting, and load on/off

Example: When the enabled cutoff activation condition is set only to elapsed time (ETime) and Level is set to 10 seconds

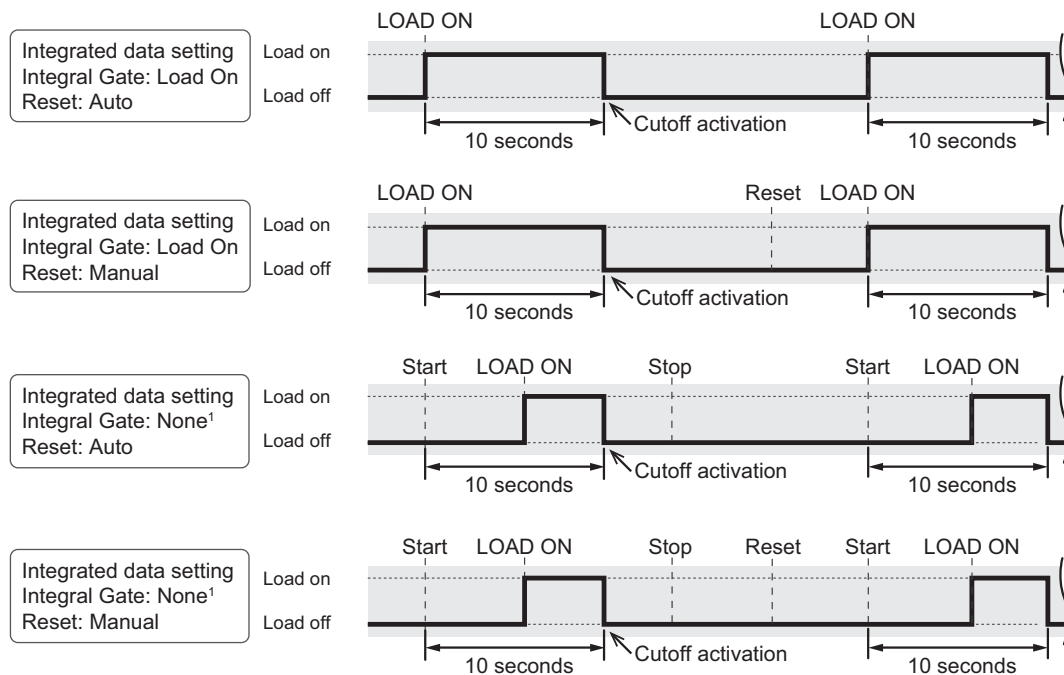

1 When Integral Gate is set to Program Run, the operation is similar as when None is specified. Read Start as sequence start, Stop as sequence stop, and LOAD ON as Load On step start.

### ■ Turning the load on again after cutoff

Even when the load is turned on, if the cutoff activation condition is satisfied, the cutoff is activated immediately and the load turns off. To turn the load on again, reset the integrated data, change the cutoff activation condition, or disable the cutoff that caused the activation.

## When cutoff is activated

When any of the enabled cutoff items (elapsed time, voltage drop, integrated current, or integrated power) reaches the specified value, cutoff is activated, and the load turns off. If a cutoff is activated, the icon corresponding to the item that caused it appears in the top area of the display. The activation cause icon remains displayed until the load is turned on the next time.

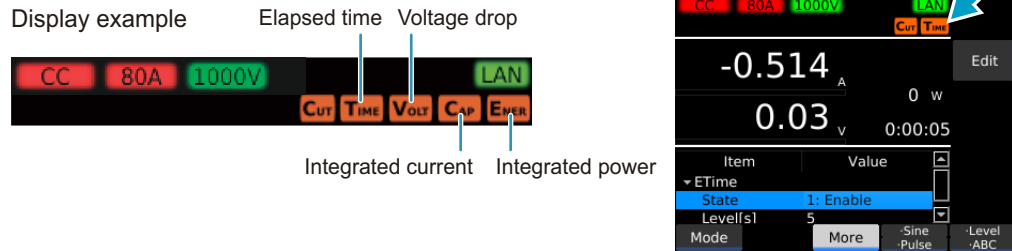

### NOTE

If a cutoff occurs due to a voltage drop, check the DUT state before measuring again.

# Types of Memory

The product has two types of memory, ABC preset memories and setup memory.

ABC preset memories are for storing three sets (A, B, and C) of load values. Because you can recall saved settings just by pressing a key, this feature is useful when you want to switch between the three sets of values in order.

Setup memory stores all basic settings.

## ■ Differences between ABC preset memories and setup memory

Parameter	ABC preset memories	Setup Memory
Number of memory entries	3	20 (internal memory) Depends on the memory size (USB memory)
Memory name	A, B, C	0 to 19 (internal memory) Any name (USB memory)
Saved setting	Load values for each operation mode (current, voltage, conductance, power)	Load on/off state Operation mode Load values (current, voltage, conductance, power) Slew rate Pulse amplitude Pulse interval Sine amplitude Sine frequency Alarm 2 operating conditions ABC preset memories
When load is on	Memory entries can be saved or recalled.	Memory entries can be saved but not recalled
When load is off	Memory entries can be saved or recalled.	Memory entries can be saved or recalled.

# ABC Preset Memories

Load values can be saved in any of the three memories A, B, or C.

The load values for each operation mode saved to the memories are as follows.

Operation mode	Load value
CC mode	Current
CR mode	Conductance
CP mode	Power
CV mode	Voltage
ARB mode	Number of table rows, voltage, current

## Saving to ABC preset memories

You can save settings regardless of whether the load is on or off. Alarm operating conditions are not saved.

**1 Enter the load settings in the operation mode that you want to save in.**

**2 Press ABC to select ABC.**

Each time you press the key, the selected item changes.

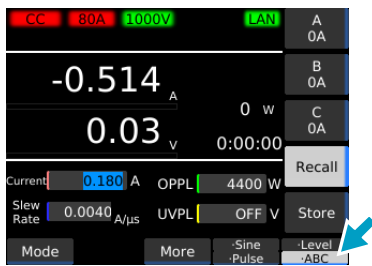

**3 Press Store.**

**4 Press a sub-function keys to select the memory (A, B, C) you want to save to, and then press ENTER.**

A confirmation pop-up message appears. Use the left and right arrow keys to select OK, and press ENTER.



**5 Press ENTER.**

The settings are saved to the selected memory. If setting have already been saved, they are overwritten.

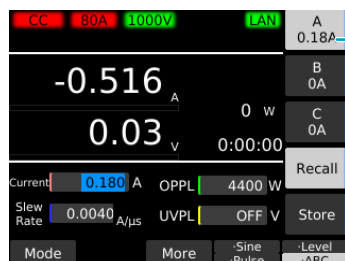

The saved load value is displayed. (except ARB mode)

Example: CC mode, saved to memory A



## Recalling ABC preset memory entries

You can recall settings regardless of whether the load is on or off.

If the settings that you recall cause alarm operating conditions to be exceeded, an alarm will occur.

### NOTE

Alarm operating conditions are not saved to ABC preset memories.

### 1 Set the operation mode to the same setting as that in the memory you want to recall.

Memories cannot be recalled if the operation mode is different.

### 2 Press ABC to select ABC.

Each time you press the key, the selected item changes.



### 3 Press Recall.

### 4 Press the sub-function key (A, B, or C) for the memory to be recalled.



The saved load value is displayed.  
(except ARB mode)

Example: CC mode

The ABC preset memory is recalled.

# Setup Memory

The setup memory can store up to 20 sets (0 to 19) of the current conditions of the items listed below. The current conditions can also be saved in a USB memory device.

- Load on/off state
- Operation mode
- Load values (current, voltage, conductance, power)
- Slew rate
- Pulse amplitude (current/conductance or percentage)
- Pulse interval (frequency/time of one cycle and duty cycle/operating time on the high side)
- Sine amplitude (current)
- Sine frequency
- Alarm operating conditions
- Content of ABC preset memories

## How to view the setup memory edit screen

Press SYSTEM and then Recall Save to display the setup memory edit screen. The internal memory contains an empty setup memory set. Connecting a USB memory device to the USB port on the front panel displays an "sdxx" folder (the "xx" changes depending on the USB memory device) enabling you to save and recall the setup memory from the USB memory device.

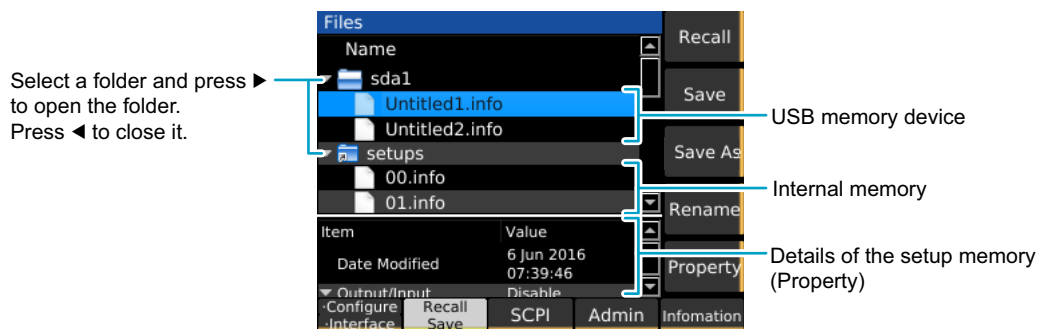

## Saving to the setup memory

### Saving over previous settings (internal memory and USB memory)

- 1 Set the operation mode and settings to the states you want to save them in.
- 2 Press **SYSTEM > Recall Save**.

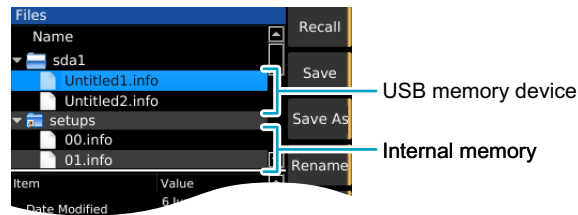

Connecting a USB memory device to the USB port on the front panel displays an “sdxx” folder (the “xx” changes depending on the USB memory device).

- 3 Use the rotary knob to select the setup memory.
- 4 Press **Save**.  
The setting contents are saved to the setup memory.

### Saving to a new file (USB memory device only)

- 1 Set the operation mode and settings to the states you want to save them in.
- 2 Press **SYSTEM > Recall Save**.
- 3 Insert a USB memory device into the USB port on the front panel.  
An “sdxx” folder is displayed. The “xx” changes depending on the USB memory device.
- 4 Use the rotary knob to select the sdxx folder, and press **Save As**.  
A new setup memory is created.

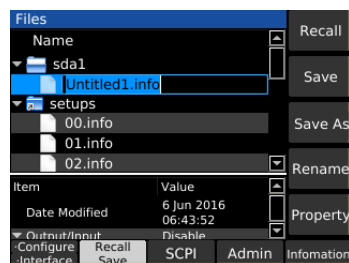

- 5 Use the numeric keypad or the rotary knob to enter a file name of your choice, and then press **ENTER**.

Be sure to add an extension (.info) to the file name.  
The setup memory is saved to a new file.

## Changing the memory name (USB memory device only)

- 1** Press **SYSTEM > Recall Save**.
- 2** Insert a **USB memory device into the USB port on the front panel**.  
An “sdxx” folder is displayed. The “xx” changes depending on the USB memory device.
- 3** Use the rotary knob to select the setup memory, and press **Rename**.

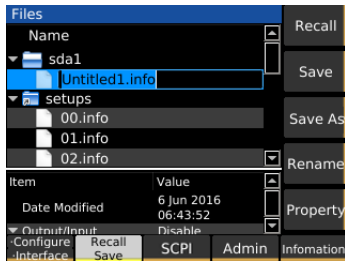

- 4** Use the numeric keypad or the rotary knob to enter a file name of your choice, and then press **ENTER**.  
Be sure to add an extension (.info) to the file name.  
The memory name is saved.

## Checking the setup memory details

- 1** Press **SYSTEM > Recall Save**.
- 2** Use the rotary knob to select the setup memory.
- 3** Press **Property**.  
The detailed information of the setup memory is displayed. The detailed information can be scrolled by using the rotary knob.  
Press Property again to return to the original state.

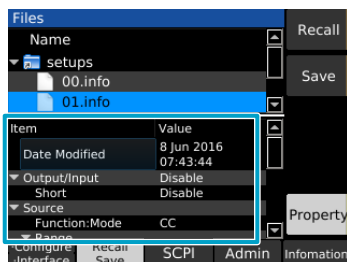

## Recalling the setup memory

You can recall memory content when load is turned off.

**1 Press SYSTEM > Recall Save.**

**2 Use the rotary knob to select the setup memory.**

Press Property to view the setting content of the setup memory.

Connecting a USB memory device to the USB port on the front panel displays an “sdxx” folder (the “xx” changes depending on the USB memory device).

**3 Press Recall.**

The setting content of the selected setup memory is recalled.

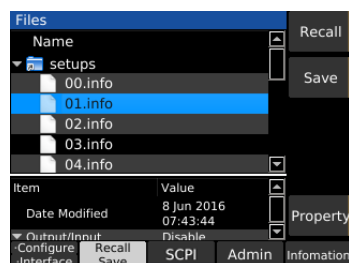

## Sharing the setup memory with the PLZ-5W

### ■ Loading a file saved on the PLZ-5W into the PLZ-5WH2 (USB memory device)

A file saved on the PLZ-5W (PLZ205W, PLZ405W, PLZ1205W) to a USB memory device can be loaded into this product. All the above items can be loaded, but the following operations will be different.

- If +CV mode is set on the PLZ-5W, the UVP action of this product will be Limit.
- If +CV mode is not set on the PLZ-5W, the UVP action of this product will be Trip.
- The current ranges and voltage ranges set on the PLZ-5W are handled as PLZ-5W's H range on this product.

### ■ Loading a file saved on the PLZ-5WH2 into the PLZ-5W (USB memory device)

- If the UVP action is set to Limit on this product, +CV mode will be set on the PLZ-5W (PLZ205W, PLZ405W, PLZ1205W).

# Synchronized Operation

If you interconnect the PLZ-5WH2 series products with LAN cables, synchronized operation can be performed from any of the connected products.

- Synchronizing the load on/off operation
- Synchronizing measurement recording (remote control only)
- Synchronizing the starting and resuming of sequences

Any of the models in the PLZ-5WH series or PLZ-5WH2 series can be connected together. Synchronized operation is possible even during parallel operation.

## ■ Simple setting using LAN cables

Common LAN cables (straight-through) up to 3 m long can be used. If you need to use a LAN cable longer than 3 m, please contact your Kikusui agent or distributor.

## Connection for synchronized operation

- 1** Turn off all the PLZ-5WH2 series products that you will connect.
- 2** Remove the SYNC/PARALLEL port cover.

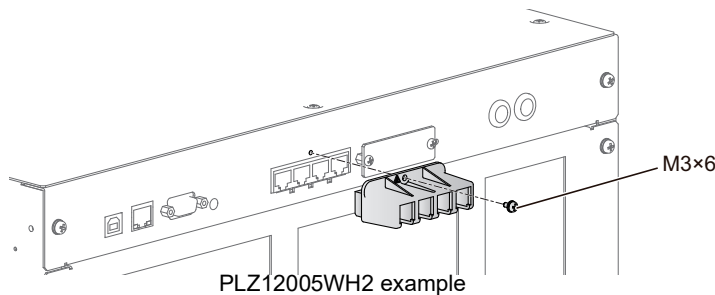

**3 Connect all the PLZ-5WH2 series products with LAN cables.**

Connect the OUT port of EXT SYNC of the product to the IN port of EXT SYNC of another unit with a LAN cable.

Connection example

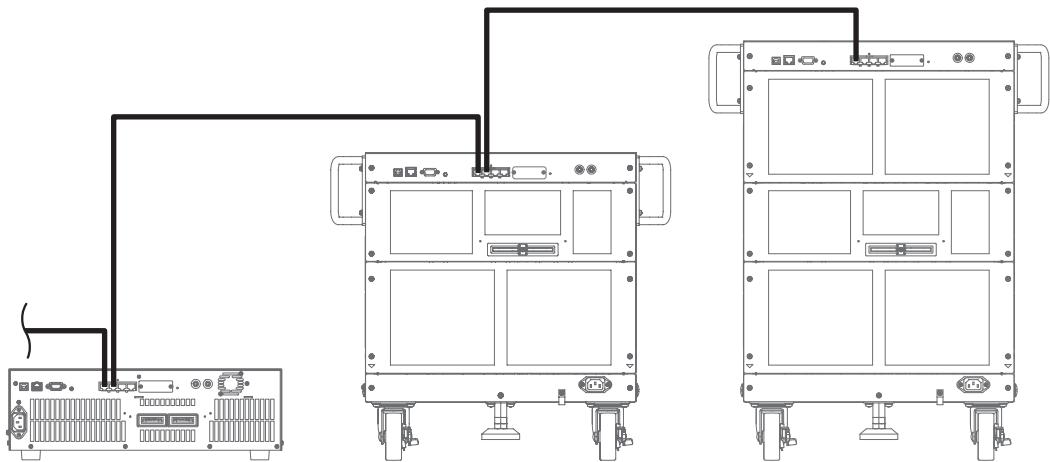
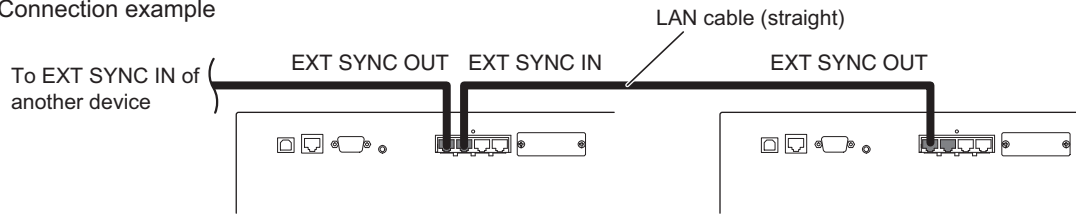

**4 When you complete the connection, attach the SYNC/PARALLEL port cover.**

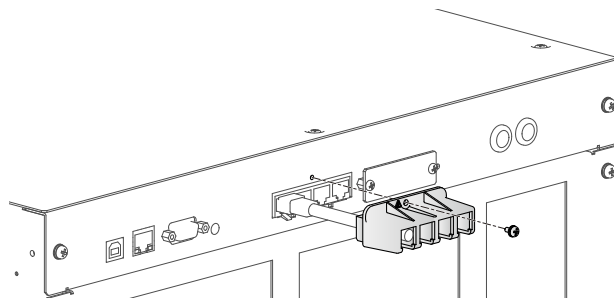

PLZ12005WH2 example

This completes the connections.

## Synchronizing the load on/off operation

You can synchronize the load on/off operation on multiple synchronized PLZ-5WH2 series products.

**1** Press **SOURCE > More**.

**2** Press **Sync Enable**.

Load on/off synchronization switches between enabled and disabled each time you press the key. When load on/off synchronization is enabled, “Load On” and “Load Off” appear in the sub-function area.



**3** Perform **Step 1** and **Step 2** on all the PLZ-5WH2 series products you want to synchronize.

**4** Press **Load On** or **Load Off** on any of the synchronized PLZ-5WH2s.

The load on/off operation will be synchronized among all PLZ-5WH2 series products whose load on/off synchronization was enabled.



## Synchronizing measurement recording

Measurement recording (p. 55) can be synchronized among multiple synchronized PLZ-5WH2s.

- 1 Press **MEASURE > Acquire**.
- 2 Use the rotary knob to select **Source** under **Trigger**, and then press **Edit**.
- 3 Use the rotary knob to select **MSync**, and then press **ENTER**.

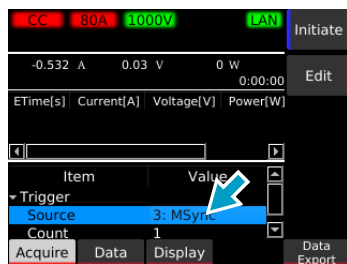

- 4 Press **Initiate**.  
The "MSync" is shown in the sub-function area.



- 5 Perform **Step 1** and **Step 4** on all the PLZ-5WH2 series products you want to synchronize.
- 6 Press **MSync** on any of the synchronized PLZ-5WH2s.  
Measurement starts simultaneously on all synchronized PLZ-5WH2 series products.

## Synchronizing the start of sequences

The start of sequences can be synchronized among multiple synchronized PLZ-5WH2 series products.

- 1 Press **SEQUENCE > More**.
- 2 Use the rotary knob to select **Source** under **Trigger**, and then press **Edit**.
- 3 Use the rotary knob to select **MSync**, and then press **ENTER**.



- 4 Execute the sequence (p. 103).

The sequence pauses before executing the next step and "Msync" appears in the subfunction area.



- 5 Perform Step 1 and Step 4 on all the PLZ-5WH2 series products you want to synchronize.
- 6 Press **MSync** on any of the synchronized PLZ-5WH2s.  
The sequence starts simultaneously on all synchronized PLZ-5WH2 series products.

## Synchronizing the resuming of sequences

A sequence will stop at a step with Wait (pre) set to MSync (p. 95).

The resuming of a paused sequence (trigger wait) can be synchronized on multiple synchronized PLZ-5WH2 series products.

### 1 Press Sequence, Transient, and then Initiate on all the PLZ-5WH2 series products to be synchronized.

The sequence is executed.



### 2 Wait for the sequence on all synchronized PLZ-5WH2 series products to be paused.

The sequence pauses (waits for trigger) before executing a step with Wait (pre) set to MSync, and “MSync” appears in the sub-function area.



### 3 Press MSync on any of the synchronized PLZ-5WH2s.

The sequence resumes simultaneously on all synchronized PLZ-5WH2 series products.

## Aborting synchronized operation

The synchronized operation setting is cleared when you remove the LAN cables.

# Remote Control

In addition to using the front panel, you can also control the product remotely by sending commands from a PC.

For details on remote control, see the Communication Interface Manual on the included CD-ROM.

## Releasing remote control

You can return the product's control from remote control (the product's panel control not accepted) to local control (panel control accepted). While remote control is in progress, the remote icon appears on the display.

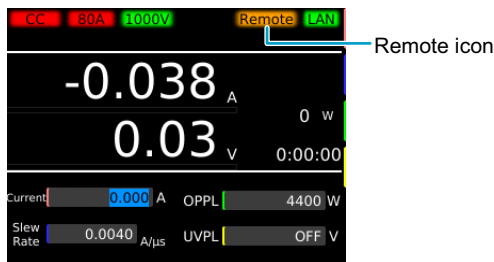

### 1 Press LOCAL.

This switches the operation from remote operation to local operation.

# Sequence Function

## Overview of the Sequence Function

Sequence is a function that executes a sequence of operations set in advance.

### Programs and steps

A sequence consists of programs and steps. A program is a collection of steps. Steps are executed in order one at a time, starting from step 1. The completion of the last step signifies that the program has been executed once. When the specified number of program loops is completed, the sequence ends.

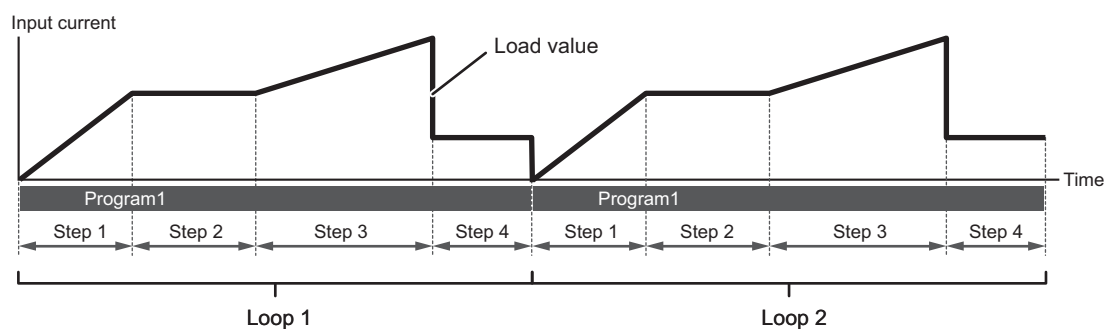

Set a program for each operation mode. Up to 30 programs can be set.  
Up to 10000 steps total can be used in all programs

**NOTE** Do not create more than 10000 steps. If the total number steps exceeds 10000, unexpected behavior may result.

### Main functions

Setting range	Setting	Description
By step	Load value	Current, conductance, voltage, power. The values that can be set depend on the current operation mode.
	Slew rate	Sets the speed of change when the current is changed.
	Step execution time	0.000050 s to 3600000 s (50 $\mu$ s to 1000 h), resolution: 1 $\mu$ s
	Load on/off control	To turn the load on, set the load setting transition method to step or ramp.
	Other	Trigger signal setting, trigger signal output
For each program	Number of loops of program	1 to 100000 repetitions, or infinite repetitions.
	Protection function	Specifies the value at which a protection function (OCP, OPP, UVP) is activated.

# Program Configuration

You can set programs in CC, CR, CV, and CP modes (ARB mode is excluded). Different programs are created for each operation mode.

## How to view the program editing screen

Press SEQUENCE and then Program to display the sequence editing screen. The program created in the present operation mode is displayed. When you change the operation mode (p.31), programs that were created in each operation mode are displayed.

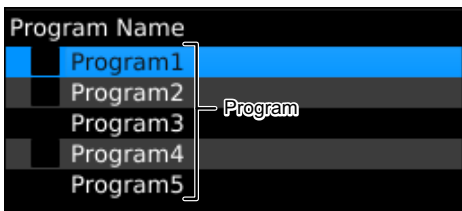

Example: Programs 1 to 5 have been registered

## Creating a program

First, create an empty program without registering any steps.

Because the location where the program is created depends on the present operation mode, even if a program of the same name is created for example in CC mode and CP mode, the resulting programs will be treated as different programs.

The created program is automatically saved and is not deleted even if the POWER switch is turned off.

- 1 Set operation mode (p.31).**
- 2 Press SEQUENCE > Program.**  
The program editing screen appears.
- 3 Press Create.**  
If another program has a check mark (is selected), you cannot create a program. If a check box is selected, use the rotary knob to select the corresponding program, and then press Select to clear the check box.

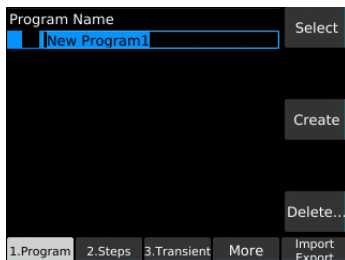

#### 4 Use the numeric keypad or the rotary knob to enter the program name, and then press ENTER.

You can enter up to 255 characters for the program name. For information about registering steps to a program, see “Setting Steps” (p.95).

An empty program is created.

## Setting the number of loops

Set the number of loops of a program.

#### 1 Press SEQUENCE > Program.

#### 2 Use the rotary knob to select a program, and then press Select.

A check mark appears to the left of the selected program name.



#### 3 Press Steps > Property > Loop.

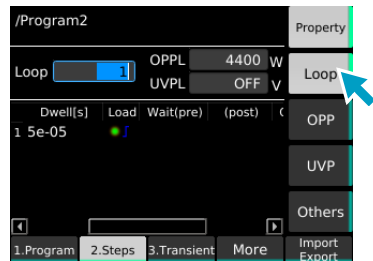

#### 4 Use the numeric keypad or the rotary knob to enter number of loops.

This completes the setting.

## Setting protection functions

For each program, you can set overcurrent protection (OCP), overpower protection (OPP), and undervoltage protection (UVP) in a program. You cannot set different protection functions for each step. The protection functions that you can set varies depending on the operation mode.

**1 Press SEQUENCE > Program.**

**2 Use the rotary knob to select a program, and then press Select.**

A check mark appears to the left of the selected program name.

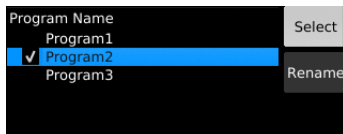

**3 Press Steps > Property > OPP, OCP, or UVP.**

The key names that appear vary depending on the operation mode.

You can select the operation (trip or limit) when an alarm occurs using the Action key.

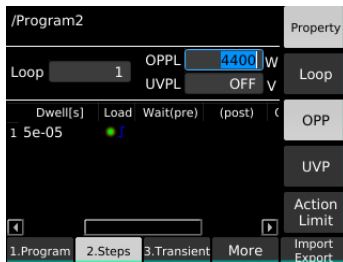

**4 Use the numeric keypad or the rotary knob to enter the value.**

This completes the setting.



## Setting the load state at the end of the sequence

You can set the load state (load on or off, load value, slew rate) at the end of the sequence of a program. If this function is disabled, at the end of the sequence, the load is set to the value of the last step.

- 1** Press **SEQUENCE > Program**.
- 2** Use the rotary knob to select a program, and then press **Select**.  
A check mark appears to the left of the selected program name.

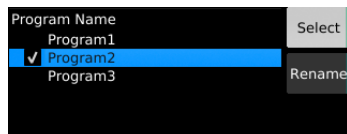

- 3** Press **Steps > Property > Others**.
- 4** Press **Enable** to switch between Enabled and Disabled.  
The value switches between Enabled and Disabled each time that you press the key.

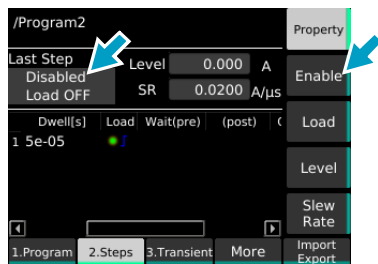

- 5** If you select **Enabled**, set the load state at the end of the sequence.

Purpose	Operation
Set load on or off.	Press Load to switch between Load ON and Load OFF. The value switches each time you press the key.
Set the load value.	Press level, and use the numeric keypad or the rotary knob to enter the load value.
Set the slew rate.	Press Slew Rate, and use the numeric keypad or the rotary knob to enter the slew rate.

This completes the setting.

## Changing a program name

- 1** Press **SEQUENCE > Program**.
- 2** Use the rotary knob to select a program, and then press **Select**.  
A check mark appears to the left of the selected program name.

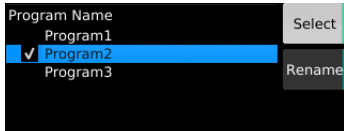

- 3** Press **Rename**.
- 4** Use the numeric keypad or the rotary knob to enter the program name, and then press **ENTER**.  
The program name is changed.

## Deleting a program

- 1** Press **SEQUENCE > Program**.
- 2** Use the rotary knob to select a program, and then press **Delete**.  
If the check box of any program is selected, you cannot delete programs. If a check box is selected, use the rotary knob to select the corresponding program, and then press **Select** to clear the check box.

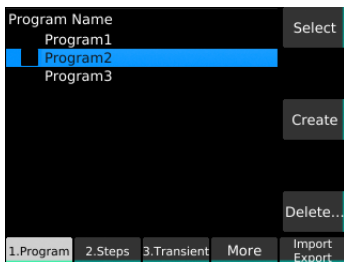

- 3** Use the rotary knob to select **OK**, and then press **ENTER**.  
The program is deleted.

# Setting Steps

## Creating steps

- 1 Press SEQUENCE > Program.**
- 2 Use the rotary knob to select a program, and then press Select.**  
A check mark appears to the left of the selected program name.
- 3 Press Steps.**  
The step editing screen appears.  
If a new step editing screen is opened, the first step with the initial value is registered.

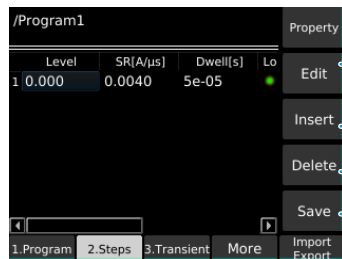

- Edit — Enables the editing of the settings of the selected step. Or confirms the settings.
- Insert — Adds a copy of the selected step below that step.
- Delete — Deletes the selected step.
- Save — Saves the edited step.

- 4 Use the rotary knob and the ←/→ keys to select a step and item, and then press Edit.**
- 5 Set each parameter.**  
Parameter (p.96): Level, SR, Dwell, Load, Wait (pre), Wait (post), Generate, →  
To confirm an item, press Edit again.
- 6 Repeat Step 4 and Step 5 until all the steps have been registered.**
- 7 Press Save.**  
The steps are registered to the program.

## Step settings

### ■ Level<sup>1</sup>

Use the numeric keypad or the rotary knob to set the load value of each operation mode. The value that you can set (unit: A, S, V, W) varies depending on the present operation mode.

- 1 This does not appear if the CC, CR, or CP external control is enabled in CC mode, CR mode, or CP mode or if the CV external control is enabled in CV mode.

### ■ SR

Use the numeric keypad or the rotary knob to set the slew rate.

### ■ Dwell

Use the numeric keypad or the rotary knob to set the step execution time. The values that you can set range from 0.000050 s to 3600000 s.

### ■ Load

Set the load state and the transition of the load value.

The load turns on and load off each time you press the Load sub-function key. If set to load on, press Immediate or Ramp to select the transition method.

Value	Description
Immediate (■ J)	The load value transitions in steps from the value of the previous step.
Ramp (■ /)	The load value transitions with a slope from the value of the previous step. If the first step (step 1) is set to ramp, the start point of the load value is always 0 A, 0 S, 0 V, 0 W.

Example: Level: 10A, Dwell: 100 ms

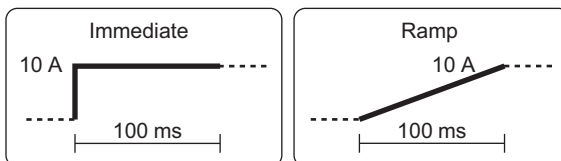

### ■ Wait (pre)

Set the pre-trigger source. If you set the pre-trigger source, the program pauses before executing a step. The pause is released when the specified trigger source condition is met.

Press MSync, Digital2, and BUS to turn each trigger source on or off. The value switches between on and off each time you press the key.

Trigger source	Description
MSync	Synchronizes the releasing of the paused state on synchronized PLZ-5WH2 series products (p. 87).
Digital2 <sup>1</sup>	Releases the pause state when a signal is received at pin 13 of the EXT CONT connector.
BUS <sup>2</sup>	Releases the pause state when a *TRG command is received from a PC or the like.

1. Only when Direction of Digital 2 is set to Input (p. 131).
2. If set to BUS, other trigger sources cannot be set.

■ Wait (post)

Set the post-trigger source. If you set the post-trigger source, the program pauses after executing a step. The pause is released when the specified trigger source condition is met.

Press Trig IN and Cutoff to turn each trigger source on or off. The value switches between on and off each time you press the key.

Trigger source	Description
Trig IN	Releases the pause state when a trigger is received (p. 118).
Cutoff	Releases the pause state when a cutoff is activated (p. 70).

■ Generate

Set the trigger signal output at the start of a step.

Press TALink and Trig Out to turn each trigger output on or off. The value switches between on and off each time you press the key.

Value	Description
TALink	A trigger is output at the start of a step. In the trigger setting (p. 56) of the measurement function, setting Source to TALink causes measurements to be recorded at the start of a step.
Trig Out	A 10 μs trigger signal is output from the TRIG OUT connector.

When Generate is set to Trig Out in step 2.

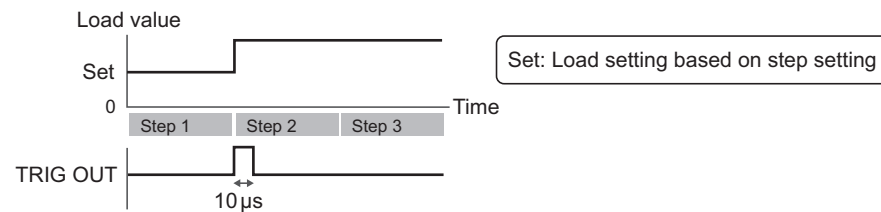

■ →

Set whether to set the EXT CONT connector pins (DIGITAL 0, 1, 2) to high level during a step.

Press Digital0, Digital1, and Digital2 to turn each item on or off. The value switches between on and off each time you press the key.

Value	Description
Digital0	Pin 11 (DIGITAL 0) of the EXT CONT connector is set to high level.
Digital1	Pin 12 (DIGITAL 1) of the EXT CONT connector is set to high level.
Digital2 <sup>1</sup>	Pin 13 (DIGITAL 2) of the EXT CONT connector is set to high level.

1. Only when Direction of Digital 2 is set to Output (p. 131).

Example: When → is set to Digital0 in step 2

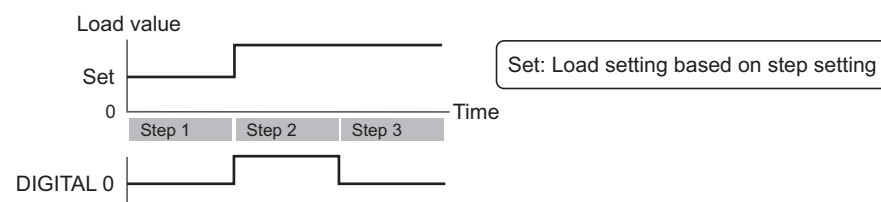

## Deleting steps



- 1 Press SEQUENCE > Steps.**
- 2 Use the rotary knob to select a step, and then press Delete.**

The selected step is deleted.
- 3 Press Save.**

The program is updated.  
This completes the setting.

# Sequence Creation Tutorial

In this example, we will actually create a sequence from the front panel.

We will enter the following program in CC mode for the PLZ12005WH2.

Program name: Program1, number of loops: 2

Run	Current	Execution time	Load	Transition	Trigger output
Step 1	8 A	10 seconds	On	Ramp	None
Step 2	6 A	12 seconds	On	Immediate	None
Step 3	0 A	7 seconds	Off	–	None
Step 4	3 A	15 seconds	On	Immediate	Trig Out

Program1 executes steps 1 to 4 and ends the first execution. When Program1 is executed one more time, this sequence is over.

Representing this sequence in graph form looks as follows.

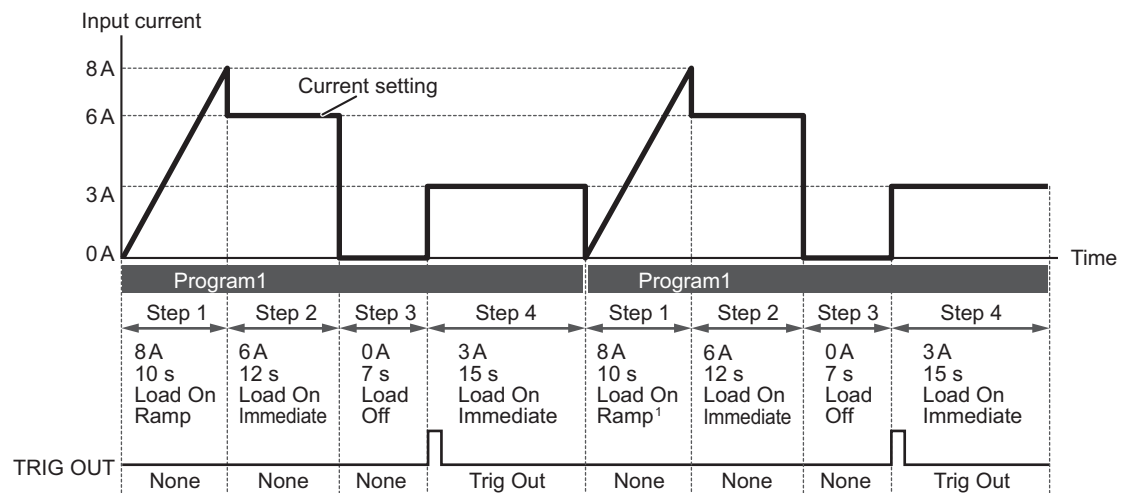

1 If Load of step 1 is set to Ramp and the program is repeated, the start current of step 1 will always be 0 A.

## Creating Program1 as a new program

- 1 Set the operation mode to CC mode (p.32).
- 2 Press SEQUENCE > Program > Create.
- 3 Use the numeric keypad or the rotary knob to enter the program name "Program1", and then press ENTER.  
Program1 is created.

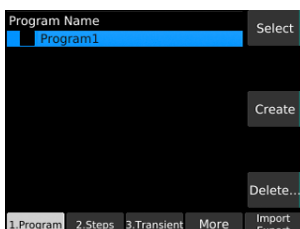

# Registering steps to Program1

When registering steps to a program, we recommend that you save the program after setting all the steps. There is no need to save a program after setting each step.

## Creating step 1

**1 Use the rotary knob to select Program1, and then press Select.**

A check mark appears to the left of Program1.

**2 Press Steps > Edit.**

The Level (current) cell of step 1 becomes editable.

**3 Use the numeric keypad or the rotary knob to enter the current value “8”, and then press Edit.**

This sets the value to 8 A.

**4 Use the → key to select a cell in the Dwell column, and then press Edit.**

Dwell (execution time) becomes editable.

**5 Use the numeric keypad or the rotary knob to enter execution time “10”, and then press Edit.**

This sets the value to 10 s.

**6 Use the → key to select a cell in the Load column, and then press Edit.**

Load (load and transition) becomes editable.

**7 Press Ramp and then Edit.**

 (load on, ramp transition) is set. Proceed to create step 2.

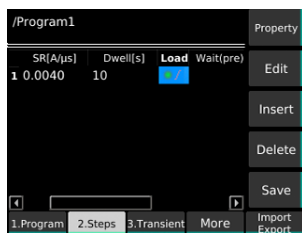



## Creating step 2

- 1 Press Insert.**  
Step 2 is inserted.
- 2 Use the ← key to select a cell in the Level column of Step 2 (row 2), and then press Edit.**
- 3 Set step 2 as follows: Level: 6, Dwell: 12, Load: On (Immediate).**  
The current is set to 6 A, the execution time to 12 s, and the load to on. Immediate transition is selected. Proceed to create step 3.

/Program1				Property
	Level	SR[A/μs]	Dwell[s]	Lo
1	8.000	0.0040	10	● /
2	6.000	0.0040	12	● /

/Program1				Property
	SR[A/μs]	Dwell[s]	Load	Wait(pre)
1	0.0040	10	● /	
2	0.0040	12	● /	

## Creating step 3

- 1 Press Insert.**  
Step 3 is inserted.
- 2 Use the ← key to select a cell in the Dwell column of Step 3 (row 3), and then press Edit.**
- 3 Set step 3 as follows: Dwell: 7, Load: Off (blank).**  
The execution time is set to 7 s and the load to off. Because the load is off in this step, there is no need to set the current. Proceed to create step 4.

/Program1				Property
	SR[A/μs]	Dwell[s]	Load	Wait(pre)
1	0.0040	10	● /	
2	0.0040	12	● /	
3	0.0040	7	● /	

/Program1				Property
	SR[A/μs]	Dwell[s]	Load	Wait(pre)
1	0.0040	10	● /	
2	0.0040	12	● /	
3	0.0040	7	● /	

## Creating step 4

- 1 Press Insert.**  
Step 4 is inserted.
- 2 Use the ← key to select a cell in the Level column of Step 4 (row 4), and then press Edit.**
- 3 Set step 4 as follows: Level: 3, Dwell: 15, Load: On (Immediate).**

Level	SR[A[μs]]	Dwell[s]	Lo
1	8.000	0.0040	10
2	6.000	0.0040	12
3	6.000	0.0040	7
4	3.000	0.0040	15

The current is set to 3 A, the execution time to 15 s, and the load to on. Immediate transition is selected. Proceed to setting the number of loops.

SR[A[μs]]	Dwell[s]	Load	Wait(pre)
1	0.0040	10	/
2	0.0040	12	
3	0.0040	7	
4	0.0040	15	

## Setting the number of loops

- 1 Press Property and then Loop.**
- 2 Use the numeric keypad or the rotary knob to enter number of loops “2.”**
- 3 Press Property.**

SR[A[μs]]	Dwell[s]	Load	Wait(pre)
1	0.0040	10	/
2	0.0040	12	
3	0.0040	7	
4	0.0040	15	

The number of loops is set to 2. Proceed to saving Program1.

## Saving Program1

- 1 Press Save.**  
Program1 is saved. This completes the setting.

SR[A[μs]]	Dwell[s]	Load	Wait(pre)
1	0.0040	10	/
2	0.0040	12	
3	0.0040	7	
4	0.0040	15	

# Executing, Pausing, and Stopping Sequences

When you finish setting the program and steps, you can run the sequence. You can pause or stop the sequence while it is running. By setting triggers ([p. 104](#)), you can control the timing at which sequences are to be started.

## Executing a sequence

### NOTE

- During sequence execution, the pulse function and sine function are forcibly turned off.
- When the cutoff ([p. 70](#)) activation condition is met while a sequence is running, a cutoff is activated and the load turns off, but the sequence continues running. To turn the load on again, reset the integrated data ([p. 61](#)), change the cutoff activation condition, or disable the cutoff that caused the activation.

The sequence can be executed regardless of whether the load is on or off.

- 1 Set the operation mode ([p. 31](#)) according to the sequence to be executed.**
- 2 Press SEQUENCE > Program.**
- 3 Use the rotary knob to select a program, and then press Select.**  
A check mark appears to the left of the program name.
- 4 Press Transient > Initiate.**

The sequence is executed, and the measurements and  appear on the display.



Number of running loops/total number of loops.

The running step is highlighted in blue.

## Synchronizing the start timing of sequences

The start timing of sequences can be synchronized on synchronized PLZ-5WH2 series products. For details, see “Synchronizing the start of sequences” ([p. 86](#)).

## Aborting a sequence

Pressing Abort during sequence execution stops the sequence execution in progress (if the load is on, it remains on).

## Pausing a sequence

### 1 Press Suspend while a sequence is running.

The sequence is paused (figure below). Press Resume to resume the sequence.



## Controlling the start of sequences with triggers

By setting triggers, you can control the timing at which sequences are to be started. The triggers that you can set are as follows:

Item	Value	Description	
Trigger	–	Sets the trigger.	
Source	–	Event (trigger source) that will be used as a condition for starting sequences. Sequence starts after the Initiate key is pressed and a trigger is received.	
	Immediate (factory default setting)	Pressing Initiate without waiting for a trigger signal applies a trigger immediately.	
	BUS	Applies a trigger when a *TRG command is received from a PC or the like.	
	DIGITAL2 <sup>1</sup>	Applies a trigger when a signal is received at pin 13 of the EXT CONT connector.	
	MSync	The trigger application timing is synced between PLZ-5WH2 series products that are synchronized (p. 86).	
Delay	0 s to 100 s	Set the delay time from trigger application until the start of sequence. The factory default setting is 0 s.	

1. Only when Direction of Digital 2 is set to Input (p. 131).

### ■ Trigger processing procedure

The following figure shows the trigger processing procedure.

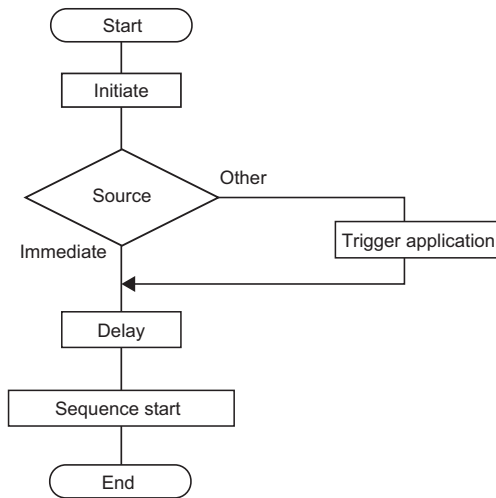

- 1** Press **SEQUENCE > More**.
- 2** Use the rotary knob to select the trigger ([p. 104](#)) you want to set, and then press **Edit**.



- 3** Use the rotary knob or numeric keys to enter a value, and then press **ENTER**.  
Repeat steps Step 2 and Step 3 to set triggers.  
This completes the setting.

# Exporting and Importing Programs

Programs saved in the internal memory can be exported to a USB memory device. Programs exported to a USB memory device can also be imported into the internal memory.

**1** Insert a USB memory device into the USB port on the front panel.

**2** Press **SEQUENCE > Import/Export**.

An Import/Export screen appears.

## ■ Basic operations on the Import/Export screen

Selected program (blue)

Name of the program being copied

Data in the internal memory

Data in the USB memory device

Selected item (blue)

Use a rotary knob to select an item, and then press **▶** to open the lower level. press **◀** to close the lower level.

Copies the selected program

Pastes the copied program

Overwrites the selected program with the copied program

Switches the selection between USB memory device and internal memory

## Exporting programs to a USB memory device

**1** On the Import/Export screen, press **USB↔Internal**, and select “Internal Memory,” which is at the top of the display area.

Each time you press **USB↔Internal**, the selection toggles between USB Memory and Internal Memory.

**2** Use the rotary knob to select the program to export, and then press **Copy**.

Exporting is not possible for programs with a check mark to the left of the program name. Displaying the program editing screen (p.90) and selecting a program with a check mark using the rotary knob clears the check box.

**3** Press **USB↔Internal**.

USB Memory is selected at the bottom of the display area.

**4** Use the rotary knob to select the export location, and press **Paste**.

To overwrite the selected file, press **Overwrite**.

A program name is displayed on the screen.

## Importing programs from a USB memory device

---

- 1 On the Import/Export screen (p. 106), press **USB ⇄ Internal**, and select “**USB Memory**,” which is at the bottom of the display area.**  
Each time you press USB ⇄ Internal, the selection toggles between USB Memory and Internal Memory.
- 2 Use the rotary knob to select the program to import, and then press **Copy**.**
- 3 Press **USB ⇄ Internal**.**  
“Internal Memory,” which is at the top of the display area, is selected.
- 4 Use the rotary knob to select the import location, and press **Paste**.**  
To overwrite the selected memory area, press Overwrite.  
The program is saved to the internal memory.

# External Control

## Preparation for External Control

The product can be controlled and monitored from an external device.

The external control terminals are isolated from the DC INPUT terminals. Moreover, the BNC connectors (V MON OUT, I MON OUT, TRIG OUT) are isolated from the chassis.

Control	Functions that can be controlled/monitored	Connector
Analog control	Controlling the load values of CC, CP, CR, and CV modes using voltage. Controlling the current to be superimposed on the load values of CC mode using voltage.	EXT CONT
Digital control	Load on/off control Sequence and measurement triggers Releasing a paused sequence Activation of an alarm Clearing an alarm state	EXT CONT
Signal output	Monitoring of the load on/off state Monitoring of the alarm state Monitoring of the sequence step period	EXT CONT
	Monitoring of the current (I MON OUT)	BNC/EXT CONT
	Monitoring of the voltage (V MON OUT)	BNC
	Pulse and sequence trigger output (TRIG OUT)	BNC

## Precautions for use at high response speeds

When the product is used at a high response speed, do not connect the common terminal of the external device to the terminal of the DUT (the terminal that is connected to the negative (-) DC INPUT terminal of the product). Attach a commercially available ferrite core to the wiring between the product and the external device.

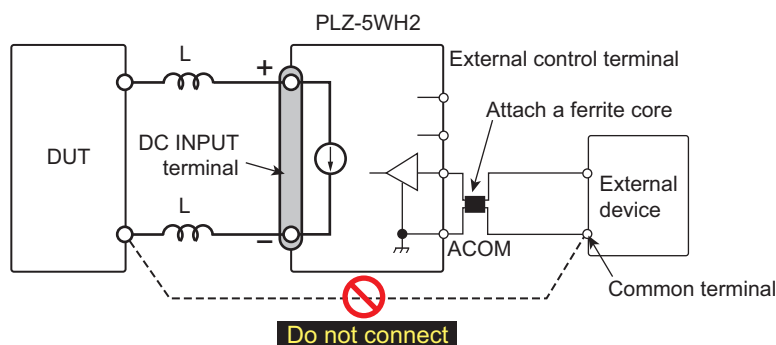



## EXT CONT connector pin arrangement

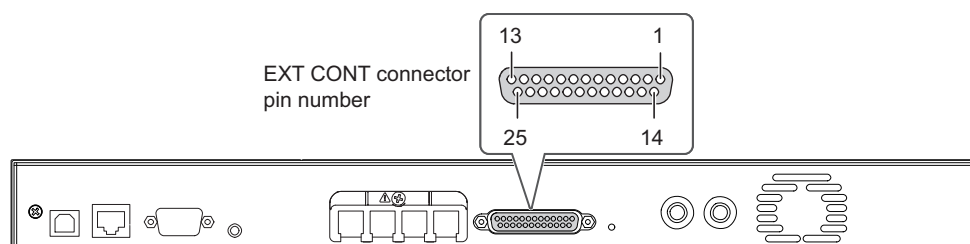

Pin no.	In/Out <sup>1</sup>	Signal name	Description
1	–	STATUS COM	Status signal common for pins 14 to 16.
2	NC	–	–
3	NC	–	–
4	NC	–	–
5	IN	ALARM CLEAR	Alarm clearing input (p. 117).
6	IN	ALARM INPUT	Alarm input (p. 117).
7	NC	–	–
8	NC	–	–
9	IN	TRIG INPUT	Trigger input. Resumes program execution if Wait(post) was set to Trig IN in a sequence step and the program was paused (p. 118).
10	–	A COM	This is connected to the chassis.
11	OUT	DIGITAL 0	DIGITAL0 output (p. 119). Sequence control possible.
12	OUT	DIGITAL 1	DIGITAL1 output (p. 119). Sequence control possible.
13	IN/OUT	DIGITAL 2	DIGITAL2 I/O (p. 119). Input/output switchable (p. 131). Sequence signal output or the trigger input of sequences and measurement function.
14	OUT	ALARM1	ALARM1 output (p. 117). ON when overvoltage detection, reverse-connection detection, overheat detection, alarm input detection, or parallel operation anomaly detection is activated, and also during external alarm input.
15	OUT	ALARM2	ALARM2 output (p. 117). ON during OCP, OPP, UVP, or WDP operation.
16	OUT	LOAD ON STATUS	Load-on status output (p. 116). ON during load on.
17	NC	–	–
18	IN	LOAD ON/OFF CONT	Load on/off control input (p. 115). Logic level switchable.
19	–	A COM	This is connected to the chassis.
20	IN	EXT CONT ADD	External voltage control input (p. 114). Controls the load setting of CC mode by adding current.
21	IN	EXT CONT MODE	External voltage control input (p. 112). Controls the load values of CC, CR, and CP modes.
22	IN	EXT CONT CV	External voltage control input (p. 113). Controls the voltage of CV mode.
23	–	A COM	This is connected to the chassis.
24	OUT	IMON	Current monitor output (p. 120).
25	NC	–	–

1. 1000 V reinforced insulation between each terminal and the DC INPUT terminal

## Connecting to the EXT CONT connector

### External control connector kit

To connect the signal cable to the EXT CONT connector, use the external control connector kit that comes with the product. For information about how to use this kit, see the TE Connectivity (formerly AMP) catalog. For information about how to obtain these tools or replacement parts, contact your Kikusui agent or distributor.

Connector model (on the product)	5747461-3 [made by TE Connectivity]
Plug model	745211-7 [made by TE Connectivity]
Wire diameter	AWG26 to AWG22
Manual pressure welding tool	Handle assembly 58074-1 [made by TE Connectivity] Head assembly 58063-2 [made by TE Connectivity]
Insertion/extraction tool	91232-1 [made by TE Connectivity] or equivalent

### Storing the protection plate

By factory default, the protection plate is mounted on the EXT CONT connector. When using the EXT CONT connector, keep the removed protection plate in a safe place. If you are not using the EXT CONT connector, attach the protection plate for your safety and to prevent external disturbances. If it is damaged or lost, contact your Kikusui agent or distributor.

### Connecting the signal cable

**NOTE**

- To prevent noise interference, use twisted wires for the signal cables.
- Use a highly stable power supply that has low noise for the external controller.

- 1** Turn the **POWER** switch off.
- 2** Remove the protection plate of the **EXT CONT** connector.

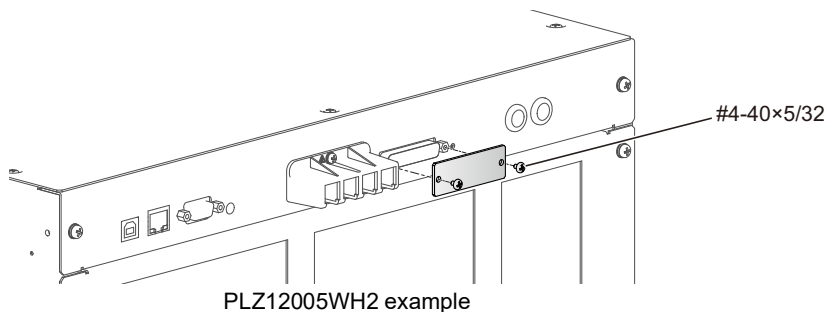

**3** Connect the signal cable to the EXT CONT connector.

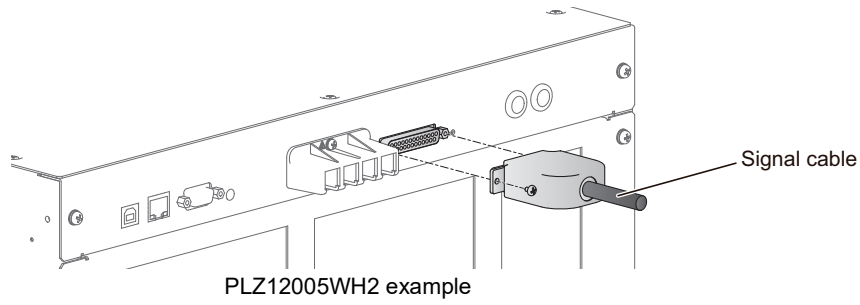

**4** Connect the signal cable to the external controller.  
This completes the external control connection procedure.

# Load Setting Control

## Constant current (CC), constant resistance (CR), and constant power (CP) control

You can control the load values (current, conductance, power) of CC, CR, and CP modes using external voltage. When you apply an external voltage between 0 V to 10 V to the EXT CONT connector, a load setting proportional to the change can be obtained.

An external voltage of 0 V results in a load setting that is 0 % of the rating, and an external voltage of 10 V results in a load setting that is 100 % of the rating. The accuracy cannot be guaranteed when the external voltage is less than 0 V or more than 10 V.

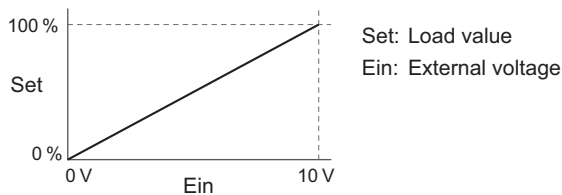

**CAUTION** To avoid damaging the product, observe the following precautions. The maximum voltage that can be applied across pins 21 and 23 of the EXT CONT connector is  $\pm 11$  V. Do not apply a voltage that exceeds this.

- 1** Turn the **POWER** switch off.
- 2** Connect an external voltage across pins 21 and 23 of the EXT CONT connector.

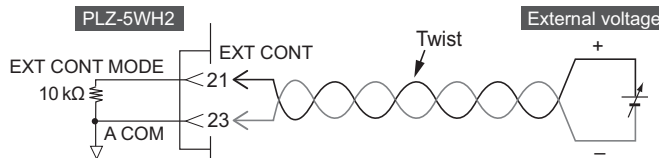

- 3** Turn the **POWER** switch on and check that the load is off.
- 4** Set the operation mode to **CC**, **CR**, or **CP**.
- 5** Press **SOURCE > More**.
- 6** Use the rotary knob to select **CC**, **CR**, or **CP** under **External Control**, and then press the **Edit** key.
- 7** Use the rotary knob to select **Enable**, and then press **ENTER**.

External control of each mode becomes possible. If **Disable** is selected, external control is disabled.

This completes the setting.

## Constant voltage (CV) control

You can control the voltage in CV mode with an external voltage. When you apply an external voltage of 0 V to 10 V to the EXT CONT connector, the voltage varies proportionally to that external voltage.

An external voltage of 0 V results in voltage of 0 V. An external voltage of 10 V results in voltage at 100 % of the rating. The accuracy cannot be guaranteed when the external voltage is less than 0 V or more than 10 V.

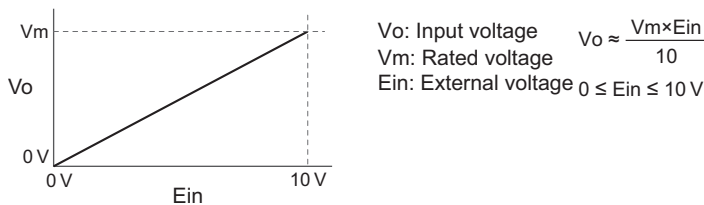

**CAUTION** To avoid damaging the product, observe the following precautions. Do not apply a voltage outside  $\pm 11 \text{ V}$  across pins 22 and 23 of the EXT CONT connector.

- 1** Turn the **POWER** switch off.
- 2** Connect an external voltage across pins 22 and 23 of the EXT CONT connector.

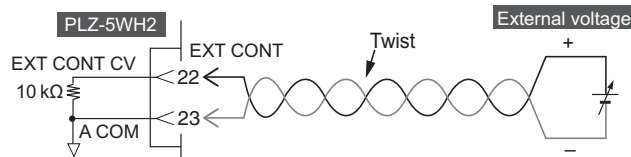

- 3** Turn the **POWER** switch on and check that the load is off.
- 4** Set the operation mode to **CV**.
- 5** Press **SOURCE > More**.
- 6** Use the rotary knob to select **CV** under External Control, and then press the Edit key.
- 7** Use the rotary knob to select **Enable**, and then press **ENTER**.

External voltage control of CV mode is now possible. If Disable is selected, external control is disabled.

This completes the setting.

**NOTE** If CV is selected under External Control, the UVP action is set to UVP Limit (p. 52). You cannot select the UVP Trip action.

## Controlling the current to be superimposed on the constant current (CC)

You can control the current to be superimposed to the current value of CC mode with an external voltage. When you apply an external voltage between 0 V to 10 V to the EXT CONT connector, the load current becomes the sum of the current proportional to the external voltage change and the Present current setting.

When you apply an external voltage between -10 V to 0 V to the EXT CONT connector, the load current is equal to the current that is proportional to the external voltage change subtracted from the present current setting.

If the current setting is  $I_s$  (figure below), the current that is added to the current setting for an external voltage of 0 V is 0 A. The current that is added to the current setting for an external voltage of  $\pm 10$  V is 100 % of the rating. However, the final load current range is 0 A to 100 % of the rating.

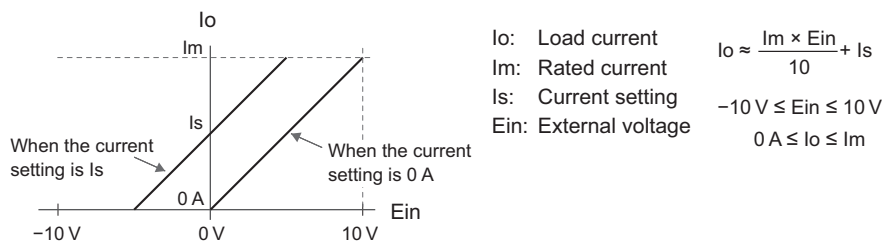

**CAUTION** To avoid damaging the product, observe the following precautions. Do not apply a voltage outside  $\pm 11$  V across pins 19 and 20 of the EXT CONT connector.

- 1 Turn the POWER switch off.
- 2 Connect an external voltage across pins 19 and 20 of the EXT CONT connector.

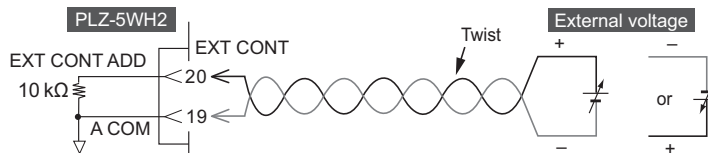

- 3 Turn the POWER switch on and check that the load is off.
- 4 Set the operation mode to CC.
- 5 Press SOURCE > More.
- 6 Use the rotary knob to select CC Add under External Control, and then press the Edit key.
- 7 Use the rotary knob to select Enable, and then press ENTER.

External control of superimposing in CC mode is now possible. If Disable is selected, external control is disabled.

This completes the setting.

# Controlling Load On/Off

You can control load on/off with an external signal. You can also monitor the load on/off state.

## Priority relationship between the operation of the external contact and the operation of the LOAD key on the front panel

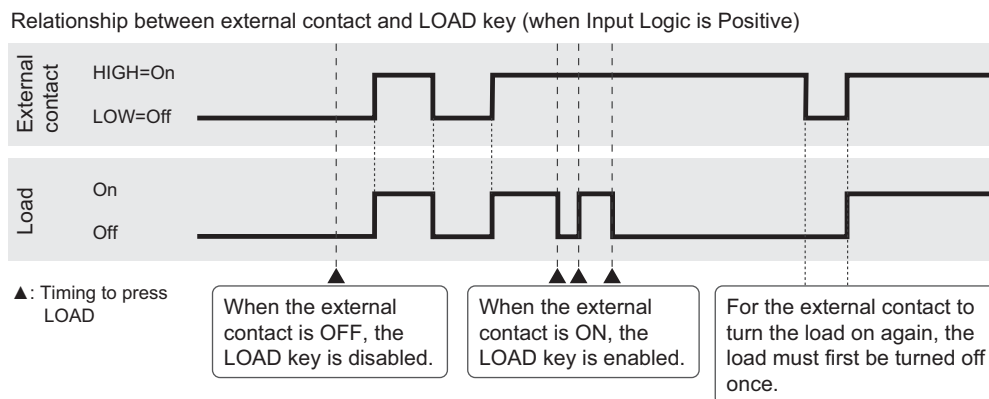

The OUPF command during remote control is equivalent to the LOAD key.

## Load on/off control input

- 1 Turn the **POWER** switch off.
- 2 Connect an external contact across pins 18 and 19 of the **EXT CONT** connector.

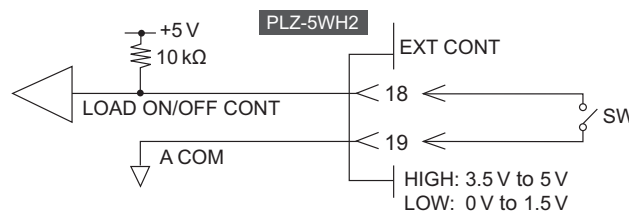

- 3 Press **SOURCE > More**.
- 4 Use the rotary knob to select **Input Logic** under **External Control**, and then press **Edit**.
- 5 Use the rotary knob to select an item, and then press **ENTER**.



Item	Description
Positive	Opening and closing the external contact turns the load on and off, respectively.
Negative	Opening and closing the external contact turns the load off and on, respectively.

External control of load on/load off is now possible.  
This completes the setting.

### Load on/off control state display

You can view the external contact state and the external contact input logic setting for the load on/off control with the icons in the top area of the display.

For example, if the external contact state is low and the external contact input logic setting is positive, you cannot turn the load on by pressing LOAD.

Icon	External contact state	External contact input logic setting (Input Logic)	LOAD key
Not shown	High	Positive	Enabled
	Low	Positive	Disabled
	High	Negative	Disabled
	Low	Negative	Enabled

### Load-on status signal output

To externally monitor the load on/load off state, use pin 16 of the EXT CONT connector. Use pin 1 as the common.

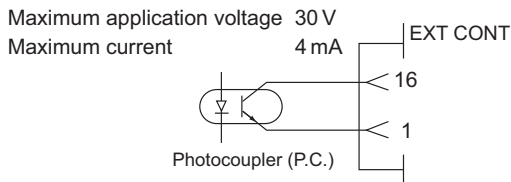

	Load on	Load off
Photocoupler	ON	OFF



# Controlling Alarms

You can use external control signals to activate and clear alarms. You can also monitor alarm occurrences.

## Alarm input

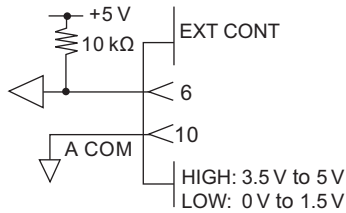

Use pin 6 of the EXT CONT connector. Use pin 10 as the common. An alarm is activated and the load is turned off when the input to pin 6 is a low level signal.

## Alarm clearing input

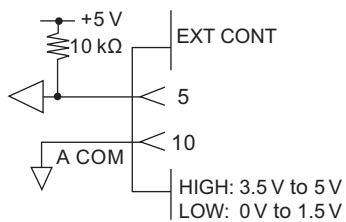

Use pin 5 of the EXT CONT connector. Use pin 10 as the common. After an alarm occurs, eliminate the root cause of the alarm, and change the input to pin 5 of the EXT CONT connector from a low level signal to a high level signal. The alarm will be cleared on the rising edge of this signal.

## Alarm status output

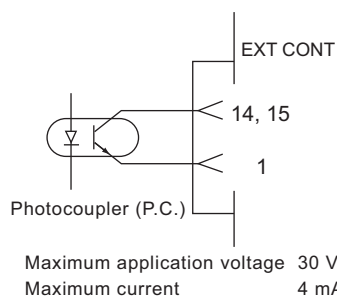

Use pin 14 (ALARM1) and pin 15 (ALARM2) of the EXT CONT connector. Use pin 1 as the common.

Pin 14 turns on when alarm 1 ([p. 48](#)) is activated.

Pin 15 turns on when alarm 2 ([p. 49](#)) is activated.

# Trigger Input/Output

The rear panel has a trigger input terminal (EXT CONT pin 9) and the front panel a trigger output terminal (TRIG OUT).

## Trigger input

When Wait(post) is set to Trig IN in a sequence step setting (p. 95), the sequence is paused at the end of the step. In this case, when the signal input to TRIG INPUT (pin 9) of the EXT CONT connector changes from high to low level, the pause is released at the falling edge of that signal.

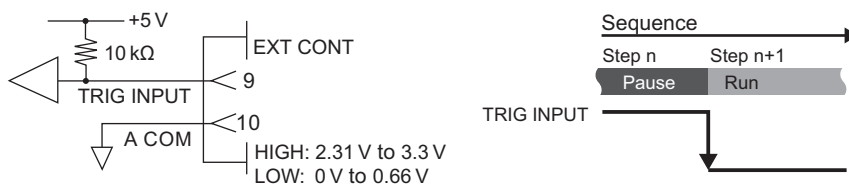

## Trigger output

The trigger signal is output under the following conditions.

Conditions	Pulse width
During pulse operation (p. 42) and during sine operation (p. 45)	10 μs
When a step for which Trig Output has been set is executed during sequence operation (p. 97).	

The trigger signal is output from the TRIG OUT connector (BNC connector) on the front panel. For the trigger signal output, the high voltage level is 4.2 V to 5 V, the low voltage level is 0 V to 0.4 V, and the output impedance is approximately 200 Ω. The isolation voltage between the BNC connectors and chassis is ±30 V. The rated voltage between BNC connectors and DC INPUT terminals is ±1000 V. The TRIG OUT connector is isolated from the chassis and DC INPUT terminal (A COM).

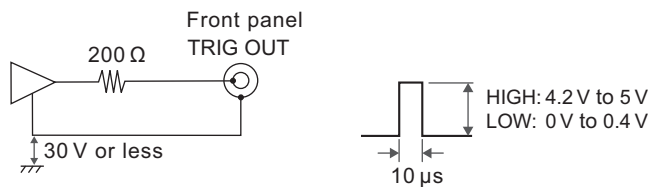

**NOTE**

- When the product is shipped from the factory, a plastic cover is attached to the TRIG OUT BNC connector. Keep the connector cover that you remove in a safe place. If you are not using the BNC connector, attach the connector cover for your safety and to prevent external disturbances.
- Use an insulated cable to connect to the BNC connector.

# Digital I/O

The rear-panel EXT CONT connectors include digital outputs DIGITAL0 (pin 11), DIGITAL1 (pin 12), and DIGITAL2 (pin 13) and digital input DIGITAL2 (pin 13). The input and output of DIGITAL2 can be switched (p. 131). Digital output is set to high level during a sequence step period. Digital input is used as a trigger input for sequence and measurement functions.

■ DIGITAL0, DIGITAL1, DIGITAL2 (output)

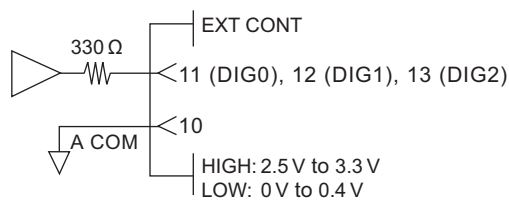

■ DIGITAL2 (input)

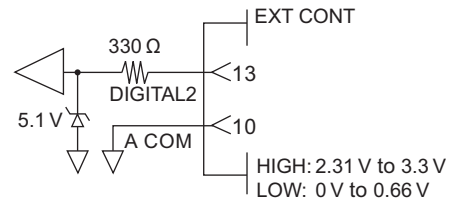

**NOTE**

The DIGITAL2 I/O terminal is not pulled up or down. If you set DIGITAL2 to input, do not leave the terminal open but rather set the terminal voltage to high or low within the input voltage range shown in the figure above.

# Current/Voltage Monitor Signal Output

You can monitor the voltage and current by using the monitor signal outputs on the front panel. The current monitor signal is output from I MON OUT and across pins 23 and 24 (pin 23 is common) of the EXT CONT connector. The voltage monitor signal is output from V MON OUT (p. 11).

I MON OUT

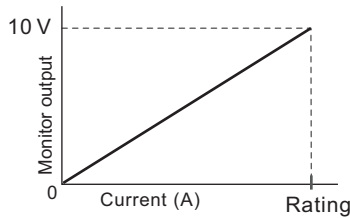

V MON OUT

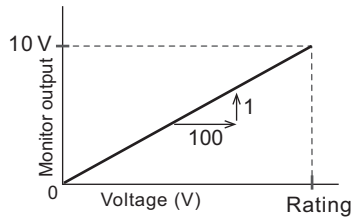

## I MON OUT and V MON OUT (BNC connectors)

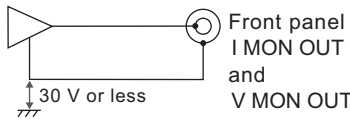

	I MON OUT	V MON OUT
Output voltage	Outputs 0 V to 10 V for 0 % to 100 % of rated current	Outputs 1/100 of the measured voltage in the 0 V to 10 V range
Maximum output current	5 mA	5 mA
Accuracy	±(1 % of rating)	±(1 % of rating)
Output impedance	50 Ω	50 Ω
Isolation voltage	±30 V	±30 V

### NOTE

- When the product is shipped from the factory, plastic covers are attached to the I MON OUT and V MON OUT BNC connectors. Keep the connector cover that you remove in a safe place. If you are not using the BNC connector, attach the connector cover for your safety and to prevent external disturbances.
- Use an insulated cable to connect to the BNC connector.

## Current monitor output (across pins 23 and 24 of the EXT CONT connector)

The current monitor output is 10 V at the rated current. The common is connected to A COM. The output impedance is 1 kΩ.

# Parallel Operation

## Overview of Parallel Operation

The PLZ-5WH2 series or Kikusui Electronic Load PLZ-5WH series can be connected in parallel to increase the total current and power capacities. The included or optional (p. 181) parallel operation signal cable kit is required for parallel connection.

You can control up to four slave units from a master unit. Parallel operation is also possible among models with different power capacities. The master unit and the slave units are automatically configured according to the connection status. The master unit displays the total current and total power for all the electronic loads that are connected in parallel.

When parallel operation is performed with PLZ-5WH, update the firmware of PLZ-5WH to the latest version. Parallel operation is possible by mixing PLZ-5WH2s and PLZ-5WHs, but when a PLZ-5WH2 is made the master unit, PLZ-5WHs cannot be connected as slave units.

### NOTE

- During parallel operation, the product may not meet the specifications that it has during independent operation. The setting accuracy and measurement accuracy can be improved by performing calibration in a parallel state. To have your product calibrated, contact your Kikusui agent or distributor.
- The setting resolution during parallel operation varies depending on the number of units in parallel operation.

### ■ Connection example

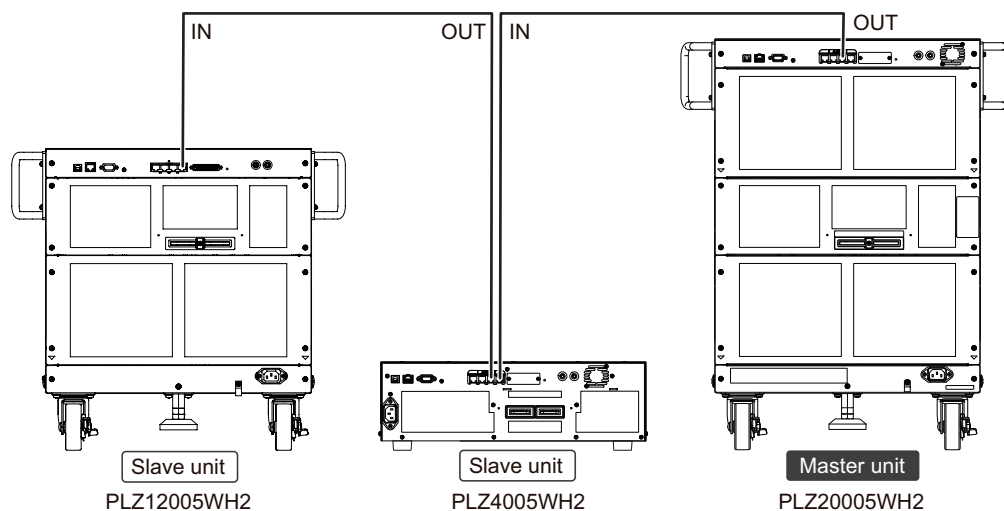

### ■ Maximum current and maximum power during parallel operation (when the models are all the same)

Number of slaves	Maximum current / Maximum power				
	PLZ1005WH2	PLZ2005WH2	PLZ4005WH2	PLZ12005WH2	PLZ20005WH2
1	40 A/2 kW	80 A/4 kW	160 A/8 kW	480 A/24 kW	800 A/40 kW
2	60 A/3 kW	120 A/6 kW	240 A/12 kW	720 A/36 kW	1200 A/60 kW
3	80 A/4 kW	160 A/8 kW	320 A/16 kW	960 A/48 kW	1600 A/80 kW
4	100 A/5 kW	200 A/10 kW	400 A/20 kW	1200 A/60 kW	2000 A/100 kW

## Making connections for parallel operation

---

Connect the electronic loads to be operated in parallel to the DUT, and connect each unit using parallel operation signal cables.

- 
- ⚠ WARNING**
- **Using improper cables may cause fire. Use load cables with a core diameter that is appropriate for the amount of current being used and with sturdy, flame-resistant insulation.**
  - **Risk of electric shock. When using the PLZ-5WH2 as the master unit, do not connect Kikusui Electronic Load PLZ-5WH series as slave units.**

- ⚠ CAUTION**
- To avoid damaging the product, observe the following precautions.
- When you are performing parallel operation, be sure to use the DC INPUT terminals on the rear panel.
  - Do not connect the PARALLEL connector's IN and OUT terminals incorrectly.
  - Do not leave one end of the parallel operation signal cable connected to the PARALLEL connector when the other end is not connected.
- 

- NOTE**
- Risk of operation errors.
- Be sure to ground the product using the included power cable.
  - Check that the power plug is connected to a properly grounded outlet.
- 

➡ Continued on next page

This section explains an example of performing parallel operation using two PLZ12005WH2s.

- 1** Turn the load off of all the electronic loads to be connected in parallel.
- 2** Connect the DC INPUT terminals of each unit to the DUT.

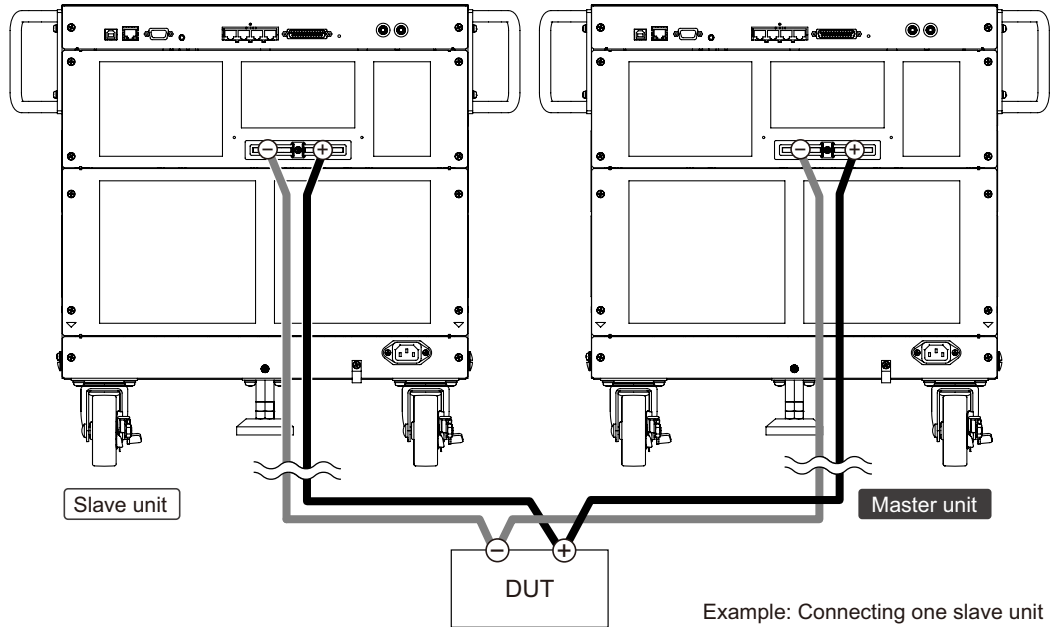

Securely connect the DC INPUT terminals of several models to each other in parallel. After making the connections, attach the DC INPUT terminal covers (p.21).

- Use load cables that are as short as possible and have sufficient thickness for the current to be used.
- Route the load cables as far as possible from the signal cables.
- Use load cables that are all of the same length (equalize the voltage drop in the load cables).

- 3** Remove the SYNC/PARALLEL connector cover.

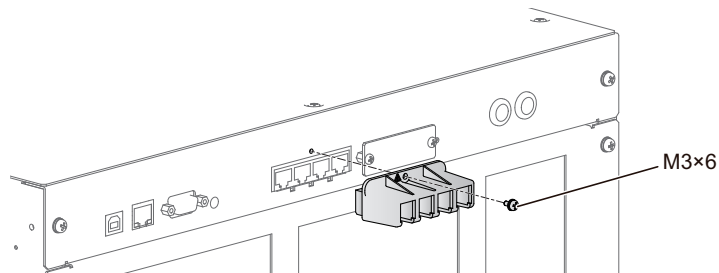

**4 Connect all the electronic loads to be operated in parallel with parallel operation signal cables.**

Connect the PARALLEL OUT connector and IN connector with a parallel operation signal cable.

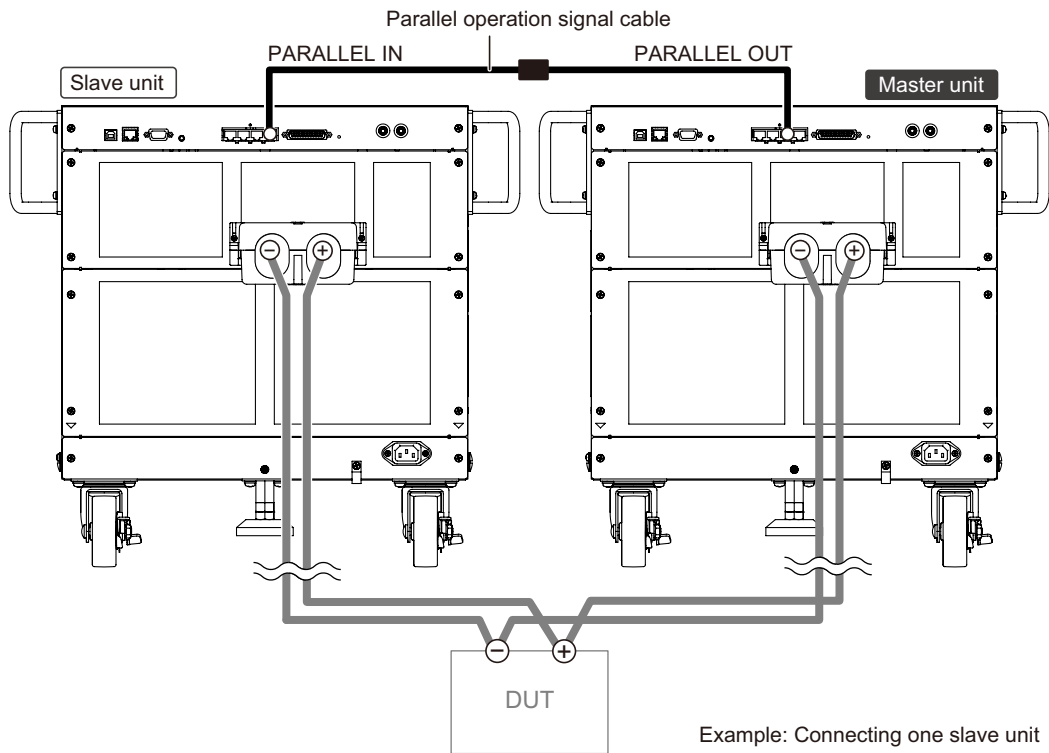

**5 Attach the SYNC/PARALLEL port cover.**

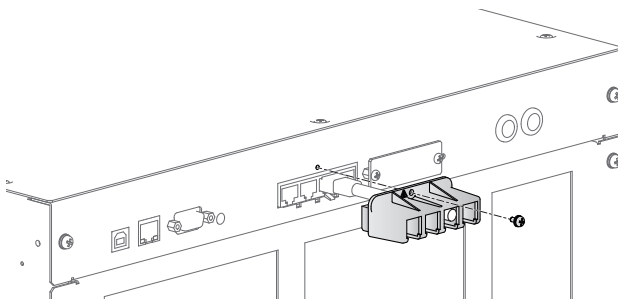

This completes the connections.

## Performing parallel operation

Once a parallel connection is made, the master unit and slave units are automatically identified, so parallel operation can be used immediately.

For the operating range, see the appendix (p. 179).

You can turn the POWER switches of all the electronic loads on or off in any order.



## Slew rate and response speed settings during parallel operation

During parallel operation, the slew rate and response speed settings on the master unit are used. The slew rate increases proportionally to the number of units operating in parallel. For details, see “Slew rate during parallel operation” (p. 179).

In the following cases, set the response speed (p. 65) to Normal to ensure stable operation.

- If the inductance of the wiring will be increased and large voltage drops will occur owing to current changes.
- If the control of the electronic loads becomes unstable and oscillation phenomena may occur owing to phase lag of the current.

## Protection function during parallel operation (parallel operation anomaly detection)

When an anomaly occurs during parallel operation, the following alarms appear on the displays of the master and slave units, and the loads are turned off. Eliminate the root cause of the alarm, and then clear the alarm.

Display	Applicable unit	Activation condition	Clearing method
Parallel Communication Alarm	Master unit	A communication anomaly was detected during parallel operation.	Restart <sup>1</sup>
Parallel Slave Over Temperature Alarm	Master unit	An overheating of a slave unit was detected.	Press ENTER on the master unit.
OTP/Front Alarm	Slave unit	An overheating of master unit was detected. A current of 30 A or more flowed through the front-panel DC INPUT terminals of the master unit. <sup>2</sup>	Press ENTER on the master unit.
AC Fail Alarm	Master unit	A slave unit's power supply was interrupted.	Restart <sup>1</sup>
Parallel Master Lost Alarm	Slave unit	The master unit cannot be detected.	Restart <sup>1</sup>
Alarm	Slave unit	An alarm of another unit was detected.	Press ENTER on the master unit.
Incorrect Slave Alarm	Master unit	A Kikusui PLZ-5WH series or PLZ-5W series <sup>3</sup> electronic load was connected to a slave unit.	Restart <sup>1</sup>

1. You can turn the POWER switches of all the electronic loads off or on in any order.
2. PLZ1005WH2, PLZ2005WH2, PLZ4005WH2 only.
3. PLZ12005WH, PLZ20005WH, PLZ205W, PLZ405W, PLZ1205W, or PLZ2405WB.

## Changing from parallel operation back to standalone operation

Turn off all the units connected for parallel operation, and then remove all connections for parallel operation. Then, connect for standalone operation.



### CAUTION

To avoid damaging the product, observe the following precautions. Do not perform stand-alone operation with the parallel operation signal cable left connected to the PARALLEL connector.

# System Settings

## Displaying and Changing CONFIG Settings

You can set the following parameters using the CONFIG settings.

Parameter	Value <sup>1</sup>	Description
Remote Sensing	Enable/ <u>Disable</u>	Remote sensing ( <a href="#">p. 69</a> ).
Power On	RST/RCL0/ <u>Resume</u>	Panel settings at startup ( <a href="#">p. 127</a> ).
Watchdog	Enable/ <u>Disable</u>	Watchdog protection setting ( <a href="#">p. 53</a> ).
Delay	1 second to 3600 seconds (1 second unit) Factory default is 60 seconds.	Time until watchdog times out.
Screen Saver	Enable/ <u>Disable</u>	Screen saver ( <a href="#">p. 128</a> ).
Delay	60 seconds to 59940 seconds (after setting, rounded to nearest second unit) Factory default is 60 seconds.	Time until the screen saver starts.
Key	Enable/ <u>Disable</u>	Key lock ( <a href="#">p. 129</a> ).
Lock Level	Low/Medium/ <u>High</u>	Key lock level ( <a href="#">p. 129</a> ).
Beeper	–	Beep sound setting ( <a href="#">p. 130</a> ).
Key	<u>Enable/Disable</u>	Beep sound for invalid operation.
Protection	<u>Enable/Disable</u>	Beep sound for alarm occurrence.
SCPI	<u>Enable/Disable</u>	Beep sound for SCPI errors.
Digital2	–	–
Direction	<u>Input/Output</u>	I/O direction of DIGITAL2 signal ( <a href="#">p. 131</a> ).

1. Factory default settings are underlined.

### Remote sensing

You can enable or disable remote sensing. For details on remote sensing, see “Remote Sensing” ([p. 67](#)).

## Panel settings at startup

The panel setting state at power-on can be selected.

Parameter	Description
RST	Start with the reset settings ( <a href="#">p. 139</a> ).
RCL0	Start in setup memory ( <a href="#">p. 78</a> ) 0 condition.
Resume	Start with the same settings as when the power was switched off the previous time (but always load off).

### 1 Press SYSTEM.

If the Configure screen does not appear, press Configure.

### 2 Use the rotary knob to select Power on, and then press Edit.

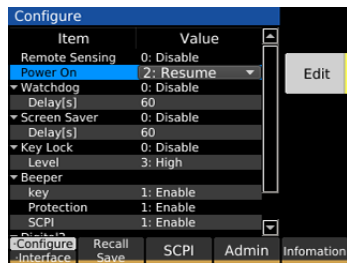

### 3 Use the rotary knob to select a parameter, and then press ENTER.

This completes the setting.

## Watchdog protection setting (WDP)

You can enable or disable WDP and set the WDP value. For details on WDP, see “Setting watchdog protection (WDP)” ([p. 53](#)).

## Screen saver

The screen saver starts and the display dims when there is no panel activity for a specified length of time. Set the time until the screen saver starts.

- 1 Press SYSTEM.**  
If the Configure screen does not appear, press Configure.
- 2 Use the rotary knob to select Screen Saver, and then press Edit.**

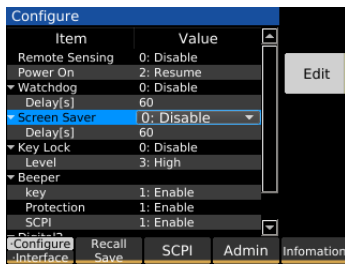



- 3 Use the rotary knob to select Enable, and then press ENTER.**  
Selecting Disable disables the function.
- 4 Use the rotary knob to select Delay, and then press Edit.**
- 5 Use the numeric keypad or the rotary knob to set the time until the screen saver is activated, and press ENTER.**  
This completes the setting.

## Key lock

The keys can be locked to prevent changing the settings or overwriting memory or sequences by mistake.

### Setting the key lock level

You can set three different key lock levels according to the type of keys whose operation is prohibited. While key lock is enabled, an icon is shown in the top area of the display depending on the key lock level. While the keys are locked, you cannot switch to the Configure screen. To set the key lock level, release the key lock in advance.

Level	Description	Icon
1:Low	Locks all operations except the following. <ul style="list-style-type: none"> <li>• Release key lock</li> <li>• Load on/off</li> <li>• Used to recall setup memory.</li> <li>• ABC preset memory recall</li> </ul>	
2:Medium	Locks all operations except the following. <ul style="list-style-type: none"> <li>• Release key lock</li> <li>• Load on/off</li> </ul>	
3:High	All key operations are locked except key lock release.	

#### 1 Press SYSTEM.

If the Configure screen does not appear, press Configure.

#### 2 Use the rotary knob to select Level under Key Lock, and then press Edit.

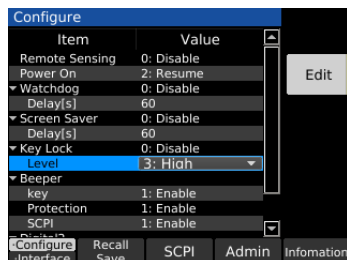

#### 3 Use the rotary knob to select the key lock level.

#### 4 Press ENTER.

This completes the setting.

## Enabling the key lock from the SYSTEM screen

- 1 Press SYSTEM.**  
If the Configure screen does not appear, press Configure.
- 2 Use the rotary knob to select Key Lock, and then press Edit.**
- 3 Use the rotary knob to select Enable, and then press ENTER.**  
Key lock is enabled.  
To clear the key lock, hold down ENTER on the front panel.

## Enabling or disabling the key lock from the front panel

- 1 Hold down KEY LOCK.**  
Each time KEY LOCK is held down, key lock is enabled or disabled.

## Setting the beep sound

You can enable or disable beep sounds that are emitted in case of invalid operation, alarm occurrence, or SCPI error.

- 1 Press SYSTEM.**  
If the Configure screen does not appear, press Configure.
- 2 Use the rotary knob to select the following items under Beeper, and then press Edit.**

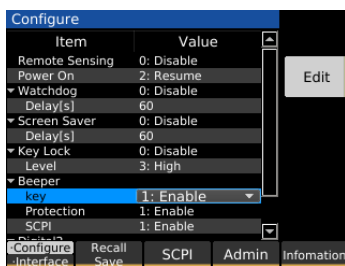

Parameter	Description
Key	Beep sound for invalid operation
Protection	Beep sound for alarm occurrence
SCPI	Beep sound for SCPI errors

- 3 Use the rotary knob to select Enable or Disable, and then press ENTER.**  
This completes the setting.

## Setting the DIGITAL2 signal input/output

### 1 Press SYSTEM.

If the Configure screen does not appear, press Configure.

### 2 Use the rotary knob to select Direction under Digital2, and then press Edit.

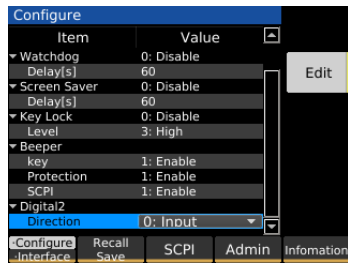

### 3 Use the rotary knob to select Input (digital input) or Output (digital output), and then press ENTER.

This completes the setting.

# Displaying/Changing the Interface Settings

You can set the following parameters.

Items that have the ✓ mark in the “Reset” column are returned to their factory default values when the interface settings are reset.

Parameter	Value <sup>1</sup>	Description	Reset
IP Address	–	IP address	
Method	<u>Automatic</u> (auto)/Static (fixed)	IP address assignment method	✓
IP Address	–	IP address	–
Subnet Mask	–	Subnet mask	–
Default Gateway	–	Default gateway	–
DNS Server	–	DNS server address	
DNS Server 1	–	Primary DNS server address	–
DNS Server 2	–	Secondary DNS server address	–
WINS Server	–	WINS server address	
WINS Server 1	–	Primary WINS server address	–
WINS Server 2	–	Secondary WINS server address	–
Host name & Services	–	Host name and service	
Desired Hostname	Enter the host name (up to 15 characters). Factory default is model name and serial number.	Host name setting	–
Desired Description	Enter the service name (up to 63 characters). Factory default is KIKUSUI XXXX Electronic Load (XXXX = model name) and serial number.	mDNS service name setting	–
Dynamic DNS	<u>Enable</u> /Disable	Setting of dynamic DNS	✓
mDNS	<u>Enable</u> /Disable	Setting of multicast DNS	✓
NetBIOS Over TCP/IP	<u>Enable</u> /Disable	NetBIOS Over TCP/IP setting	✓
Auto Clock Adjustment	–	Auto clock	
NTP Server Hostname	ntp.nict.jp	NTP server address	–
Auto Adjustment	<u>Enable</u> /Disable	Setting of auto clock adjustment	–
RS232C Settings	–	RS232C settings	
Baudrate	9600/ <u>19200</u> / 38400/ 57600/ 115200	Baud rate [bps]	–
Data Bits	<u>8</u> (fixed)	Data length	–
Stop Bits	1 (fixed)	Stop bits	–
Flow Control	<u>None</u> / CTS-RTS	Flow control	–

1. Factory default settings are underlined.



**1 Press SYSTEM > Interface.**

The Interface (View Mode) screen appears.

If the Interface screen does not appear, press Interface again.

View Mode is for checking the settings. You cannot change the settings.

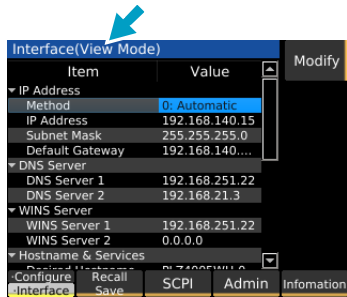
**2 Press Modify.**

The Interface (Modify Mode) screen appears. You can change the settings in Modify Mode.

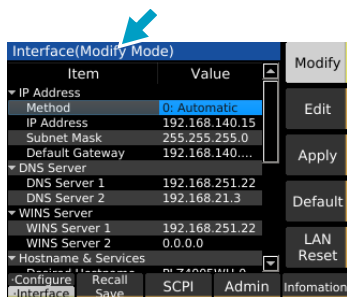
**3 Use the rotary knob to select the parameter, and then press Edit.****4 Use the numeric keys or rotary knob to enter a value, and then press ENTER.****5 Press Apply.**

A confirmation screen appears.

**6 Press ENTER.**

This completes the setting. The screen switches to View Mode.

## Resetting the interface settings

---

Interface settings that have a ✓ mark in the reset column in (p. 132) above are returned to the factory default setting.

- 1 Press SYSTEM > Interface.**  
If the Interface screen does not appear, press Interface again.
- 2 Press Modify > LAN Reset.**  
A confirmation screen appears.
- 3 Press ENTER.**  
The interface setting is reset.

## Returning the interface settings to the factory default values

---

- 1 Press SYSTEM > Interface.**  
If the Interface screen does not appear, press Interface again.
- 2 Press Modify > Default.**  
A confirmation screen appears.
- 3 Press ENTER.**  
The interface settings are returned to the factory default values.

# Displaying SCPI Errors

---

You can check the content of the SCPI error when an SCPI error occurs during remote control.

Up to 16 errors are displayed. If the 17th error occurs, the 16th error changes to “-350 Queue overflow,” and subsequent errors are not displayed.

## 1 Press **SYSTEM > SCPI**.

The SCPI error is displayed. For details on errors, see the Communication Interface Manual on the included CD-ROM.

Pressing Clear or restarting the product will clear the error.

# Setting the Date/Time

The date and time are used when saving setup memory.

If you change the time zone, the year, month, and day change accordingly.

If the product is connected to LAN and can access the Internet, the year, month, and day will be updated automatically when you set the time zone.

**1 Press SYSTEM > Admin > Date/Time.**

**2 Set the time zone and the date and time.**

Each time you press Tab, the item that you can set changes.

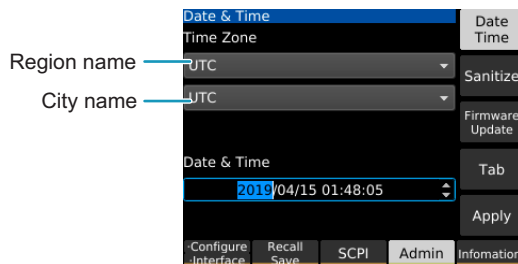

Purpose	Operation
Set the time zone (region name)	Press Tab to select the item in the top row of Time Zone, and then use the rotary knob to select the region name.
Set the time zone (city name)	Press Tab to select the item in the bottom row of Time Zone, and then use the rotary knob to select the city name.
Set the year, month, day, and time.	Press Tab to select the year, month, day, or time of Date & Time, and use the numeric keypad or rotary knob to enter the value.

**3 Press Apply.**

This completes the setting.

# Factory Default Settings and Reset Settings

The product provides “factory default settings” and “reset settings” as default settings.

## Restoring the factory default settings

Restoring the factory default settings deletes all the user data\*.

For details about the factory default setting, see “Main settings at factory default and at reset” (p. 139).

\*: The user data is deleted in accordance with the NISPOM (National Industrial Security Program Operating Manual) standard.

You can also return only the interface settings to their factory default values (p. 134).

### 1 Press SYSTEM > Admin > Sanitize.



### 2 Press Execute.

A confirmation screen appears.

### 3 Use the rotary knob to select OK, and then press ENTER.

The product restarts, and the factory default settings are restored.

#### NOTE

The error “-314 Save/recall memory lost” always occurs after the product restarts, but this is actually not an error.

## Restoring the reset settings

You can reset some of the settings to their factory defaults.

For the items that are reset, see “Main settings at factory default and at reset” (p. 139).

You can also reset only the interface settings (p. 134).

### Resetting at power-on

**1 Press SYSTEM.**

If the Configure screen does not appear, press Configure.

**2 Use the rotary knob to select Power on, and then press Edit.**

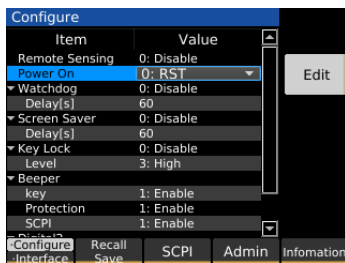

**3 Use the rotary knob to select RST, and then press ENTER.**

**4 Turn the POWER switch off and then back on.**

The product restarts with some of the settings reset to their factory defaults.

### Resetting immediately

**1 Press SYSTEM > SCPI.**

**2 Press \*RST.**

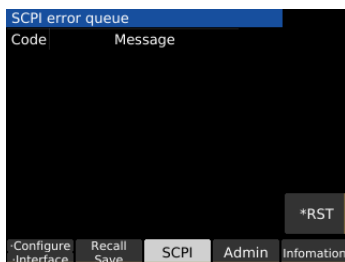

A confirmation screen appears.

**3 Press ENTER.**

Some of the settings are reset.

## Main settings at factory default and at reset

The main settings at factory default and at reset, for each of the settings that can be done with the SOURCE key, MEASURE key, SEQUENCE key, and SYSTEM key, are listed below. All items that have the ✓ mark in the “Reset” column are returned to their factory default values upon reset.

### SOURCE function settings

Parameter		Factory default	Reset
Operation mode		CC	✓
CC range (CR range)		H range	✓
Current		0 A	✓
Conductance		0 S	✓
Voltage		0 V	✓
Power		0 W	✓
ABC preset value	CC mode	0 A	✓
	CR mode	0 S	✓
	CV mode	0 V	✓
	CP mode	0 W	✓
Response speed for CR mode		Normal	✓
Response speed for CV mode		Normal	✓
Response speed for ARB mode		500 μs	✓
Soft start time		500 μs	✓
Cutoff	Elapsed time	Disable	✓
	Voltage drop	Disable	✓
	Integrated current	Disable	✓
	Integrated power	Disable	✓
External control	CC/CR/CP mode	Disable	✓
	CV mode	Disable	✓
	CC Add	Disable	✓
	Input Logic	Positive	✓
Pulse	Function	Disable	✓
	Current (Depth)	0 A	✓
	Conductance (Depth)	0 S	✓
	Duty cycle	50 %	✓
	Frequency	1 Hz	✓
Sine	Function	Disable	✓
	Amplitude	0 A	✓
	Frequency	1 Hz	✓
Number of data points of I-V characteristics		3 (all 0 A)	✓

## SOURCE function settings (continued)

Parameter	Factory default					Reset
	PLZ1005WH2	PLZ2005WH2	PLZ4005WH2	PLZ12005WH2	PLZ20005WH2	
Slew rate	0.001 A/μs	0.002 A/μs	0.004 A/μs	0.01 A/μs	0.02 A/μs	✓
Overcurrent protection setting	22 A	44 A	88 A	264 A	440 A	✓
Operation at overcurrent protection activation	Limit					✓
Overpower protection setting	1100 W	2200 W	4400 W	13200 W	22000 W	✓
Operation at overpower protection activation	Limit					✓
Undervoltage protection setting	OFF					✓
Operation at undervoltage protection activation	Limit					✓

## MEASURE function settings

Parameter		Factory default	Reset
Measurement function	Number of measurement values to be recorded	1	✓
	Delay	0 s	✓
	Measurement interval function (Interval)	Disable	✓
	Measurement interval time (Interval Time)	0.1 s	✓
	Trigger source	Immediate	✓
	Measurement time (Sense Aperture)	0.1 s	✓
Integrated data recording function	Integrated data recording period (Integral Gate)	Load On	✓
	Resetting of integrated data before start of recording (Reset)	Auto	✓
Integrated data display	Elapsed time	Enable	✓
	Integrated current	Disable	✓
	Integrated power	Disable	✓

## SEQUENCE function settings

Parameter	Factory default	Reset
Program	No program	–
Trigger source	Immediate	–
Trigger delay	0 s	–



## SYSTEM function settings

Parameter		Factory default	Reset
Remote sensing		Disable	–
Panel settings at startup (Power On)		Resume	–
Watchdog protection function		Disable	–
Set time for watchdog protection function (Delay)		60 s	–
Screen saver		Disable	–
Screen saver startup time (Delay)		60 s	–
key lock		Disable	–
Key lock level		High	–
Beep sound	In case of invalid operation (Key)	Enable	–
	In case of alarm activation	Enable	–
	In case of SCPI error	Enable	–
I/O direction of DIGITAL2 signal		Input	–
Time zone		UTC <sup>1</sup>	–

1. If reset to the factory default value, set the date and time ([p. 136](#)).

For details on the factory default settings and reset settings for the interface, see “Displaying/Changing the Interface Settings” ([p. 132](#)).

# Updating

You can update the product's firmware by using a USB memory device.

If there is an update, you can obtain it from the download service on the Kikusui website (<http://www.kikusui.co.jp/en/download/>).

**NOTE**

Save the update files (Update.img, CHECKSUM.md5) in the root directory of the USB memory device. Do not change the names of the update files.

## 1 Press SYSTEM > Admin > Firmware Update.

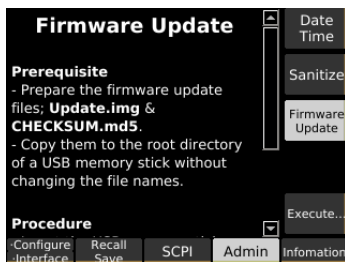

## 2 Insert the USB memory device on which the update files have been saved into the USB port on the front panel, and then press Execute.

An update screen appears.

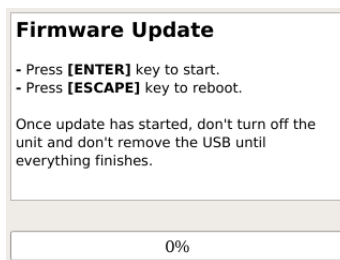

## 3 Press ENTER.

The update process begins. Do not turn off the POWER switch while updating is in progress. Do not remove the USB memory device.

## 4 After the update complete screen appears, turn the POWER switch off and then back on.

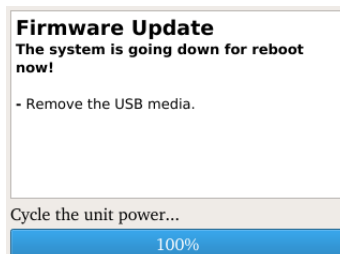

Updating is complete.

# Displaying the Device Information

You can display the model name, serial number, firmware version, IP address, and other device information.

## 1 Press **SYSTEM > Information**.

The device information is displayed. You can scroll the screen by turning the rotary knob.

If a connection is established when IP Address > Method is set to Automatic in the interface settings (p. 132) (the LAN connection status icon in the upper right of the display is green), the automatically assigned IP address is displayed next to IP Address.



# Maintenance

---

## Inspection

---

To purchase accessories or options, contact your Kikusui agent or distributor.

## Overhaul

---

The electrolytic capacitors and fan motor inside the product are consumable parts.

We recommend that you have the product overhauled every 10000 operating hours or so (the frequency depends on the usage conditions), along with internal inspection and cleaning. To have your unit overhauled, contact your Kikusui agent or distributor.

## Backup battery replacement

---

The product has a battery inside. The battery's service life differs depending on the environment that the product is used in, but three years after it is purchased is a rough estimate for the battery's service life. When the battery is exhausted, the time becomes inaccurate. For information about replacing the battery, contact your Kikusui agent or distributor.

## Calibration

---

The product is calibrated before shipment. To maintain long-term performance, we recommend periodic calibration. To have your product calibrated, contact your Kikusui agent or distributor.

# Specifications

Unless specified otherwise, the specifications are for the following settings and conditions.

- The product is warmed up for at least 30 minutes.
- Rear-panel DC INPUT terminals are used.

The used terminology is as follows:

- TYP: These are typical values that are representative of situations where the product operates in an environment with an ambient temperature of 23 °C (73.4 °F). These values do not guarantee the performance of this product.
- setting: Indicates a setting.
- reading: Indicates a readout value.
- rating: Indicates a rated value.
- Open: Indicates equivalence to the state in which the DC INPUT terminals are opened.

## Rating

Parameter	PLZ1005WH2	PLZ2005WH2	PLZ4005WH2	PLZ12005WH2	PLZ20005WH2
Operating voltage (DC)	10 V ~ 1000 V				
Power	1000 W	2000 W	4000 W	12000 W	20000 W
Current	20 A	40 A	80 A	240 A	400 A
DC INPUT terminal's isolation voltage	Positive pin: $\pm 1\ 000\ V$ , Negative pin: $\pm 900\ V$				
Minimum operating voltage	At the rated current	10 V			
	When the current begins to flow	1.5 V or less			

## Constant current (CC) mode

Parameter	PLZ1005WH2	PLZ2005WH2	PLZ4005WH2	PLZ12005WH2	PLZ20005WH2
Operating range	0 A to 20 A	0 A to 40 A	0 A to 80 A	0 A to 240 A	0 A to 400 A
Setting range	0.0000 A to 20.2000 A	0.000 A to 40.400 A	0.000 A to 80.800 A	0.00 A to 242.40 A	0.00 A to 404.00 A
Resolution	0.0005 A	0.001 A	0.002 A	0.005 A	0.01 A
Setting accuracy	$\pm(0.2\ \% \text{ of setting} + 0.1\ \% \text{ of rating})$				
Parallel operation	$\pm(0.4\ \% \text{ of setting} + 0.2\ \% \text{ of rating})$				

## Constant resistance (CR) mode

Parameter		PLZ1005WH2	PLZ2005WH2	PLZ4005WH2	PLZ12005WH2	PLZ20005WH2
Operating range <sup>1</sup>	H range	500 mS to 0 S	1 S to 0 S	2 S to 0 S	6 S to 0 S	10 S to 0 S
	L range	5 mS to 0 S	10 mS to 0 S	20 mS to 0 S	60 mS to 0 S	100 mS to 0 S
Setting range	H range	505.00 mS to 0.00 S	1.01000 S to 0.00000 S	2.02000 S to 0.00000 S	6.0600 S to 0.00000 S	10.1000 S to 0.0000 S
	L range	5.05000 mS to 0.00000 S	10.1000 mS to 0.0000 S	20.2000 mS to 0.0000 S	60.600 mS to 0.000 S	101.000 mS to 0.000 S
Resolution	H range	0.01 mS	0.00002 S	0.00005 S	0.0002 S	0.0002 S
	L range	0.0001 mS	0.0002 mS	0.0005 mS	0.002 mS	0.002 mS
Setting accuracy <sup>2</sup>	H range	$\pm(0.5 \% \text{ of setting} + 0.5 \% \text{ of rating}^3)$				
	L range	$\pm(0.5 \% \text{ of setting} + 0.2 \% \text{ of rating}^3)$				
Parallel operation	H range	$\pm(1.0 \% \text{ of setting} + 1.0 \% \text{ of rating}^3)$				
	L range	$\pm(1.0 \% \text{ of setting} + 0.4 \% \text{ of rating}^3)$				
Response speed		NORM/FAST				

1. Conductance [S] = input current [A]/input voltage [V] = 1/resistance [ $\Omega$ ]
2. Converted value at the input current. At the sensing point during remote sensing.
3. Rated current

## Constant voltage (CV) mode

Parameter	All models
Operating range	10 V to 1000 V
Setting range	0.00 V to 1010.00 V
Resolution	0.02 V
Setting accuracy <sup>1</sup>	$\pm(0.05 \% \text{ of setting} + 0.05 \% \text{ of rating})$
Parallel operation	$\pm(0.1 \% \text{ of setting} + 0.1 \% \text{ of rating})$
Response speed	NORM/FAST

1. With the input voltage within the operating range, and at the sensing point during remote sensing.

## Constant power (CP) mode

Parameter	PLZ1005WH2	PLZ2005WH2	PLZ4005WH2
Operating range	0 W to 1000 W	0 W to 2000 W	0 W to 4000 W
Setting range	0.00 W to 1010.00 W	0.00 W to 2020.00 W	0.0 W to 4040.0 W
Resolution	0.02 W	0.05 W	0.1 W
Setting accuracy	$\pm(0.5 \% \text{ of rating}^1 + 0.02 \text{ A} \times \text{Vin}^2)$	$\pm(0.5 \% \text{ of rating}^1 + 0.04 \text{ A} \times \text{Vin}^2)$	$\pm(0.5 \% \text{ of rating}^1 + 0.08 \text{ A} \times \text{Vin}^2)$
Parallel operation	$\pm(1 \% \text{ of power rating} + 0.1 \% \text{ current rating} \times \text{Vin}^2)$		

1. Rated power
2. DC INPUT terminal voltage or SENSING terminal voltage.

Parameter	PLZ12005WH2	PLZ20005WH2
Operating range	0 W to 12000 W	0 W to 20000 W
Setting range	0.0000 kW to 12.1200 kW	0.0000 kW to 20.2000 kW
Resolution	0.0005 kW	
Setting accuracy	$\pm(0.5 \% \text{ of rating}^1 + 0.2 \text{ A} \times \text{Vin}^2)$	$\pm(0.5 \% \text{ of rating}^1 + 0.4 \text{ A} \times \text{Vin}^2)$
Parallel operation	$\pm(1 \% \text{ of power rating} + 0.1 \% \text{ current rating} \times \text{Vin}^2)$	

1. Rated power
2. DC INPUT terminal voltage or SENSING terminal voltage.

## Arbitrary I-V characteristics (ARB) mode

Parameter	All models
Operating range	Three to 100 points of current values can be specified for the input voltage. Linear interpolation is applied between specified points.
Response speed	500 $\mu$ s, 1 ms, 2 ms, 5 ms, 10 ms, 20 ms, 50 ms, 100 ms, or off

## Measurement function

### Voltmeter

Parameter	All models
Display	0.00 V to 1000.00 V
Resolution	10 mV
Accuracy	$\pm(0.05\% \text{ of reading} + 0.05\% \text{ of rating})$
Parallel operation	$\pm(0.1\% \text{ of reading} + 0.1\% \text{ of rating})$ (TYP)

### Ammeter

Parameter	PLZ1005WH2	PLZ2005WH2	PLZ4005WH2	PLZ12005WH2	PLZ20005WH2
Display	0.000 A to 20.000 A	0.000 A to 40.000 A	0.000 A to 80.000 A	0.00 A to 240.00 A	0.00 A to 400.00 A
Resolution	0.001 A	0.001 A	0.001 A	0.01 A	0.01 A
Accuracy	$\pm(0.2\% \text{ of reading} + 0.1\% \text{ of rating})$				
Parallel operation	$\pm(0.4\% \text{ of reading} + 0.2\% \text{ of rating})$ (TYP)				

### Power display

Parameter	All models
Display	Displays the product of the voltmeter reading and ammeter reading

### Measurement trigger

Parameter	All models
Trigger Source	Immediate, BUS, DIGITAL2, MSync, TALink, LoadOff
Trigger Count	1 to 65536
Trigger Delay	0.00000 s to 100.00000 s
Interval	Disable/Enable
Interval Time	0.00001 s to 3600 s
Sense Aperture	0.00001 s to 1.00000 s



## Pulse function

Parameter	All models	
Operation mode	CC and CR	
Frequency setting range	1.0 Hz to 10.0 kHz	
Frequency setting resolution <sup>1</sup>	1 Hz to 10 Hz	0.1 Hz
	11 Hz to 100 Hz	1 Hz
	110 Hz to 1000 Hz	10 Hz
	1.1 kHz to 10.0 kHz	0.1 kHz
Frequency setting accuracy	1 Hz to 5.0 kHz	±(0.5 % of setting)
	5.1 Hz to 10.0 kHz	±(1.0 % of setting)
Duty cycle setting range, step	1 Hz to 10 Hz	5.0 % to 95.0 %, 0.1 % steps
	11 Hz to 100 Hz	
	110 Hz to 1000 Hz	
	1.1 kHz to 10.0 kHz	5 % to 95 % <sup>2</sup> , 1 % steps

- (Reference) The resolution actually set in the device is period resolution  $\Delta T = 1 \mu\text{s}$ , as shown in the equation below. For example, if you specify 9300 Hz, the period set in the device will be  $n \times \Delta T = 108 \times 1 \mu\text{s} = 108 \mu\text{s}$  (where n is a number set in the device). Converted to frequency, this becomes  $1/108 \mu\text{s} = 9259 \text{ Hz}$ .
- The minimum time span is 20  $\mu\text{s}$ . The minimum duty cycle is limited by the minimum time span.

## Switch value (Depth)

Parameter <sup>1</sup>	PLZ1005WH2	PLZ2005WH2	PLZ4005WH2	PLZ12005WH2	PLZ20005WH2
CC mode	0.0000 A to 20.2000 A	0.000 A to 40.400 A	0.000 A to 80.800 A	0.000 A to 242.40 A	0.00 A to 404.00 A
CR mode H range	505.00 mS to 0.00 S	1010.00 mS to 0.00 S	2020.00 mS to 0.00 S	6.06000 S to 0.00000 S	10.1000 S to 0.0000 S
CR mode L range	5.0500 mS to 0.0000 S	10.1000 mS to 0.0000 S	20.2000 mS to 0.0000 S	60.600 mS to 0.000 S	101.000 mS to 0.000 S

- The switch value is limited to the set current or set conductance or less.

## Slew rate

Parameter	PLZ1005WH2	PLZ2005WH2	PLZ4005WH2	PLZ12005WH2	PLZ20005WH2
Operation mode	CC				
Operating range	0.001 A/ $\mu\text{s}$ to 1 A/ $\mu\text{s}$	0.002 A/ $\mu\text{s}$ to 2 A/ $\mu\text{s}$	0.004 A/ $\mu\text{s}$ to 4 A/ $\mu\text{s}$	0.01 A/ $\mu\text{s}$ to 12 A/ $\mu\text{s}$	0.02 A/ $\mu\text{s}$ to 20 A/ $\mu\text{s}$
Resolution	0.00002 A/ $\mu\text{s}$	0.00005 A/ $\mu\text{s}$	0.0001 A/ $\mu\text{s}$	0.0002 A/ $\mu\text{s}$	0.0005 A/ $\mu\text{s}$
Setting accuracy <sup>1</sup>	±(10 % of setting +20 $\mu\text{s}$ )				

- Time to change from 10 % to 90 % when the current is changed from 0 % to 100 % of the rated current

## Sine function

Parameter	All models	
Operation mode	CC	
Frequency setting range	1 Hz to 1000 Hz, 2000 Hz, 5000 Hz, 10000 Hz	
Frequency setting resolution <sup>1</sup>	1 Hz to 10 Hz	1 Hz
	20 Hz to 100 Hz	10 Hz
	200 Hz to 1000 Hz	100 Hz
Frequency setting accuracy	300 Hz to 900 Hz	±(1.0 % of setting)
	Other than the frequencies above	±(0.5 % of setting)

- (Reference) The resolution actually set in the device is period resolution  $\Delta T = 20 \mu\text{s}$ , as shown in the equation below. For example, if you specify 900 Hz, the period set in the device will be  $n \times \Delta T = 56 \times 20 \mu\text{s} = 1120 \mu\text{s}$  (where n is a number set in the device). Converted to frequency, this becomes  $1/1120 \mu\text{s} \approx 893 \text{ Hz}$ .

## Soft start

Parameter	All models
Operation mode	CC
Time setting range	500 $\mu\text{s}$ , 1 ms, 2 ms, 5 ms, 10 ms, 20 ms, 50 ms, 100 ms, or off

## Alarm function

### Alarm 1

Parameter	All models
Overvoltage detection	Turns off the load when a voltage that is 110 % of the rating or higher is applied.
Reverse-connection detection	Turns off the load when approximately -1 % of the rated current flows through the DC INPUT terminals.
Overheat detection, overcurrent detection of the front-panel DC INPUT terminals	Turns off the load when the heatsink temperature reaches 100 °C. Or, turns off the load when a current of 30 A or higher is flowing through the front-panel DC INPUT terminals.
Alarm input detection	Turns off the load when a voltage between 0 V and 1.5 V is applied to ALARM INPUT (pin 6) of the EXT CONT connector.
Parallel operation anomaly detection	Turns off the load when any of the following errors occurs. <ul style="list-style-type: none"> <li>• An error occurred in the communication between the master unit and slave unit during parallel operation.</li> <li>• A slave unit's power supply was interrupted.</li> <li>• An overheating was detected on the master or slave unit.</li> <li>• An overcurrent flowed through the front-panel DC INPUT terminals.</li> </ul>

### Alarm 2

Parameter		PLZ1005WH2	PLZ2005WH2	PLZ4005WH2	PLZ12005WH2	PLZ20005WH2
Overcurrent protection (OCP)	Setting range	0.000 A to 22.000 A	0.00 A to 44.00 A	0.00 A to 88.00 A	0.00 A to 264.00 A	0.0 A to 440.0 A
	Resolution	0.001 A	0.01 A	0.01 A	0.01 A	0.1 A
	Protection operation	Select load off or limit.				
Overpower protection (OPP)	Setting range	0.0 W to 1100.0 W	0.0 W to 2200.0 W	0 W to 4400 W	0.000 W to 13.200 kW	0.000 W to 22.000 kW
	Resolution	0.1 W	0.1 W	1 W	0.001 kW	0.001 kW
	Protection operation	Select load off or limit.				
Undervoltage protection (UVP)	Setting range	0.00 V to 1000.00 V, or off.				
	Resolution	0.02 V				
	Protection operation	Select load off or limit.				
Watchdog protection (WDP)	Setting range	1 s to 3600 s or off				
	Protection operation	Load off				

## Sequence function

Parameter	All models
Operation mode	CC, CR, CV, CP
Maximum number of programs	30
Maximum number of steps	10000
Step execution time	0.000050 s to 3600000 s (50 μs to 1000 h)
Time resolution	1 μs

## Integration display

Parameter	PLZ1005WH2	PLZ2005WH2	PLZ4005WH2	PLZ12005WH2	PLZ20005WH2
Elapsed time display	Displays the time from load on to load off.				
Range	0 s to 3600000 s (1000 h 0 min 0 s)				
Ampere-hour meter display	Displays integrated current				
Range	0 Ah to 70000 Ah	0 Ah to 140000 Ah	0 Ah to 280000 Ah	0 Ah to 800000 Ah	0 Ah to 1400000 Ah
Watt-hour meter display	Displays integrated power				
Range	0 Wh to 40000000 Wh	0 Wh to 80000000 Wh	0 Wh to 160000000 Wh	0 Wh to 500000000 Wh	0 Wh to 800000000 Wh

## Cutoff function

Parameter	PLZ1005WH2	PLZ2005WH2	PLZ4005WH2	PLZ12005WH2	PLZ20005WH2
Elapsed time	The load turns off when the elapsed time value reaches the specified value.				
Range	0 s to 3600000 s (1000 h 0 min 0 s)				
Resolution	1 s				
Integrated current	The load turns off when the ampere-hour meter value reaches the specified value.				
Range	0 Ah to 70000 Ah	0 Ah to 140000 Ah	0 Ah to 280000 Ah	0 Ah to 800000 Ah	0 Ah to 1400000 Ah
Resolution	0.001 mAh (0.000 mAh to 1000.000 mAh) 0.001 Ah (1.001 Ah to 1000.000 Ah) 0.001 kAh (1.001 kAh to 1000.000 kAh) 0.001 MAh (1.001 MAh to 1.400 MAh)				
Integrated power	The load turns off when the watt-hour meter value reaches the specified value.				
Range	0 Wh to 40000000 Wh	0 Wh to 80000000 Wh	0 Wh to 160000000 Wh	0 Wh to 500000000 Wh	0 Wh to 800000000 Wh
Resolution	0.001 Wh (0.000 Wh to 1000.000 Wh) 0.001 kWh (1.001 kWh to 1000.000 kWh) 0.001 MWh (1.001 MWh to 800.000 MWh)				
Voltage drop	The load turns off when the voltmeter value becomes less than or equal to the specified value.				
Range	0.00 V to 1000.00 V				
Resolution	0.02 V				

## Other functions

Parameter	All models
Remote sensing	Input voltage rating <sup>1</sup> Isolation voltage
	1000 V <sup>2</sup> ±1000 V
Number of units in parallel operation	5 units
Mutual synchronized operation <sup>3</sup>	Synchronizes load on/off. Synchronization of sequence execution, and sequence resumption. Synchronizing the recording timing of measured values.

1. There are limitations depending on the actual power that the load consumes.
2. Total potential difference between the DC INPUT terminals and SENSING terminals
3. The terminals for mutual synchronized operation are isolated from the DC INPUT terminals and operate at the chassis potential.

## Common specifications

### EXT CONT connector

Parameter <sup>1</sup>	Specifications
Load on/off control input	Logic level switchable. Pulled up to 5 V by a 10 k $\Omega$ resistor. The thresholds are HIGH: 3.5 V to 5 V, LOW: 0 V to 1.5 V.
Alarm input	An alarm is activated with a voltage between 0 V and 1.5 V. Pulled up to 5 V by a 10 k $\Omega$ resistor. The thresholds are HIGH: 3.5 V to 5 V, LOW: 0 V to 1.5 V.
Alarm clearing input	After an alarm occurs, eliminate the root cause of the alarm, and change the input to pin 5 of the EXT CONT connector from a low level signal to a high level signal. The alarm will be cleared on the rising edge of this signal. Pulled up to 5 V by a 10 k $\Omega$ resistor. The thresholds are HIGH: 3.5 V to 5.0 V, LOW: 0 V to 1.5 V.
Trigger input	Paused sequence operation resumes when a voltage between 0 V and 0.66 V is received. Pulled up to 5 V by a 10 k $\Omega$ resistor. The thresholds are HIGH: 2.31 V to 3.3 V, LOW: 0 V to 0.66 V.
External voltage control input (CC, CR, CP mode)	Controls the load settings of CC, CR, CP mode through external voltage input. Input impedance: Approx. 10 k $\Omega$ . CC: The setting can be controlled in the range of 0 % to 100 % of the rated current through external voltage input of 0 V to 10 V. CR: The setting can be controlled in the range of 0 % to 100 % of the conductance setting through external voltage input of 0 V to 10 V. CP: The setting can be controlled in the range of 0 % to 100 % of the rated power through external voltage input of 0 V to 10 V.
Setting accuracy	$\pm(1\%$ of rating) (TYP value in CC mode)
External voltage control input (CV mode)	The load setting of CV mode can be controlled through external voltage input. The rated voltage can be controlled in the range of 0 % to 100 % with 0 V to 10 V. Input impedance: Approx. 10 k $\Omega$ .
Setting accuracy	$\pm(1\%$ of rating) (TYP)
External voltage control input (superimposing in CC mode)	Controls the load setting of CC mode by adding current through external voltage input. Adds current in the range of -100 % to 100 % of the rated current for -10 V to 10 V. Input impedance: Approx. 10 k $\Omega$ .
Setting accuracy	$\pm(1\%$ of rating) (TYP)
Load-on status output	On when load is on. Open-collector output from a photocoupler. <sup>2</sup>
ALARM 1 output	ON when overvoltage detection, reverse-connection detection, overheat detection, front-panel DC INPUT overcurrent detection, alarm input detection, or parallel operation anomaly detection is activated. Open-collector output from a photocoupler. <sup>2</sup>
ALARM 2 output	Turns on when OCP, OPP, UVP, or WDP is activated. Open-collector output from a photocoupler. <sup>2</sup>
DIGITAL 0 output	Can be controlled through sequences. Output impedance: Approx. 330 $\Omega$ .
DIGITAL 1 output	The thresholds are HIGH: 2.5 V to 3.3 V, LOW: 0 V to 0.4 V.
DIGITAL 2 input/output	Input/output switchable. Output: Sequence trigger output. The output impedance is 330 $\Omega$ . The thresholds are HIGH: 2.5 V to 3.3 V, LOW: 0 V to 0.4 V. Input: Trigger input signal for the sequence and the measurement functions. The thresholds are HIGH: 2.31 V to 3.3 V, LOW: 0 V to 0.66 V.
Current monitor output	Outputs 0 V to 10 V for 0 % to 100 % of the rated current Output impedance: 1 k $\Omega$ (TYP).
Accuracy	$\pm(1\%$ of rating) (TYP)

- 1000 V reinforced insulation between each terminal and the DC INPUT terminal
- The maximum voltage that can be applied to the photocoupler is 30 V. The maximum current is 4 mA.

## BNC connector

Parameter		Specifications
Trigger output		Transmits 10 $\mu$ s pulses during step execution when trigger output is set in a sequence. Transmits 10 $\mu$ s pulses during pulse operation and sine operation. Output impedance: 200 $\Omega$ , output voltage HIGH: 4.2 V to 5.0 V, LOW: 0 V to 0.4 V.
Current monitor output	Output voltage	Outputs 0 V to 10 V for 0 % to 100 % of the rated current
	Output impedance	50 $\Omega$ (TYP)
	Accuracy	$\pm(1 \%$ of rating)
Voltage monitor output	Output voltage	Outputs the measured voltage with 1/100 magnification from 0 V to 10 V.
	Output impedance	50 $\Omega$ (TYP)
	Accuracy	$\pm(1 \%$ of rating)
Isolation voltage		$\pm 30$ V

## Communication function

Parameter		Specifications
RS232C	Hardware	D-SUB 9-pin connector. Baud rate: 9600, 19200, 38400, 115200 bps. Data length: 8 bits, Stop bits: 1 bit, Parity bit: None Flow control: No, CTS/RTS
	Message terminator	LF during reception, LF during transmission.
USB (device)	Hardware	Standard type B socket. Complies with the USB 2.0 specification. Data rate: 480 Mbps (High Speed).
	Message terminator	LF or EOM during reception, LF + EOM during transmission.
	Device class	Complies with the USBTMC-USB488 device class specifications.
USB (host)	Hardware	Standard type A socket Complies with the USB 2.0 specification. Data rate: 480 Mbps (High Speed).
LAN	Hardware	IEEE 802,3 100Base-TX/10Base-T Ethernet IPv4, RJ-45 connector.
	Compliant standards	LXI 1.4 Core Specification 2011
	Communication protocol	VXI-11, HiSLIP, SCPI-RAW, SCPI-Telnet
	Message terminator	VXI-11, HiSLIP: LF or END during reception, LF + END during transmission. SCPI-RAW: LF during reception, LF during transmission.

## General specifications

Parameter		PLZ1005WH2	PLZ2005WH2	PLZ4005WH2	PLZ12005WH2	PLZ20005WH2
Input voltage range		100 Vac to 240 Vac (90 Vac to 250 Vac) single phase				
Input frequency range		47 Hz to 63 Hz				
Power consumption		70 VAm <sub>ax</sub>	90 VAm <sub>ax</sub>	150 VAm <sub>ax</sub>	360 VAm <sub>ax</sub>	590 VAm <sub>ax</sub>
Inrush current (peak value)	100 Vac	30 Amax	30 Amax	30 Amax	40 Amax	40 Amax
	230 Vac	80 Amax	80 Amax	80 Amax	160 Amax	160 Amax
Leakage current <sup>1</sup>		0.5 mA or less	0.6 mA or less	0.8 mA or less	1.6 mA or less	2.4 mA or less
Environmental conditions	Operating temperature range	0 °C to 40 °C (32 °F to 104 °F)				
	Operating humidity range	20 %rh to 85 %rh (no condensation)				
	Storage temperature range:	-25 °C to 60 °C (-13 °F to 140 °F)				
	Storage humidity range:	90 %rh or less (no condensation)				
Installation location		Indoor use, altitude of up to 2000 m, overvoltage category II				
Insulation resistance	Between primary and chassis, input, monitor terminals	1000 Vdc, 30 MΩ or more (70 %rh or less)				
	Between input terminals and chassis, monitor terminal	1000 Vdc, 3 MΩ or more (70 %rh or less)				
Withstanding voltage	Between primary and chassis, input, monitor terminals	No abnormalities at 1500 Vac for 2 s				
	Between input terminals and chassis, monitor terminal	No abnormalities at 1500 Vac for 2 s				
External dimensions		See <a href="#">p. 156</a> .	See <a href="#">p. 156</a> .	See <a href="#">p. 157</a> .	See <a href="#">p. 158</a> .	See <a href="#">p. 159</a> .
Weight		Approx. 13 kg (28.7 lbs)	Approx. 16 kg (35.3 lbs)	Approx. 20 kg (44.1 lbs)	Approx. 64 kg (141.1 lbs)	Approx. 93 kg (205 lbs)
Accessories		See <a href="#">p. 3</a> .				
Electromagnetic compatibility <sup>23</sup>		Complies with the requirements of the following directive and standards. EMC Directive 2014/30/EU EN 61326-1 (Class A <sup>4</sup> ) EN 55011 (Class A <sup>4</sup> , Group 1 <sup>5</sup> ) EN 61000-3-2 EN 61000-3-3 Applicable under the following conditions The maximum length of all cabling and wiring connected to the product must be less than 3 m.				
Safety <sup>2</sup>		Complies with the requirements of the following directive and standards. EMC Directive 2014/35/EU <sup>3</sup> EN 61010-1 (Class I <sup>6</sup> , Pollution Degree 2 <sup>7</sup> )				

1. Leakage current between the positive and negative terminals of the rear-panel DC INPUT. At 1000 Vdc.
2. Does not apply to specially ordered or modified products.
3. Only on models that have CE/UKCA marking on the panel.
4. This is a Class A instrument. This product is intended for use in an industrial environment. This product may cause interference if used in residential areas. Such use must be avoided unless the user takes special measures to reduce electromagnetic emissions to prevent interference to the reception of radio and television broadcasts.
5. This is a Group 1 instrument. This product does not generate and/or use intentionally radio-frequency energy, in the form of electromagnetic radiation, inductive and/or capacitive coupling, for the treatment of material or inspection/analysis purpose.
6. This is a Class I instrument. Be sure to ground this product's protective conductor terminal. The safety of this product is guaranteed only when the product is properly grounded.
7. Pollution is addition of foreign matter (solid, liquid or gaseous) that may produce a reduction of dielectric strength or surface resistivity. Pollution Degree 2 assumes that only non-conductive pollution will occur except for an occasional temporary conductivity caused by condensation.

## External dimensions

### PLZ1005WH2, PLZ2005WH2

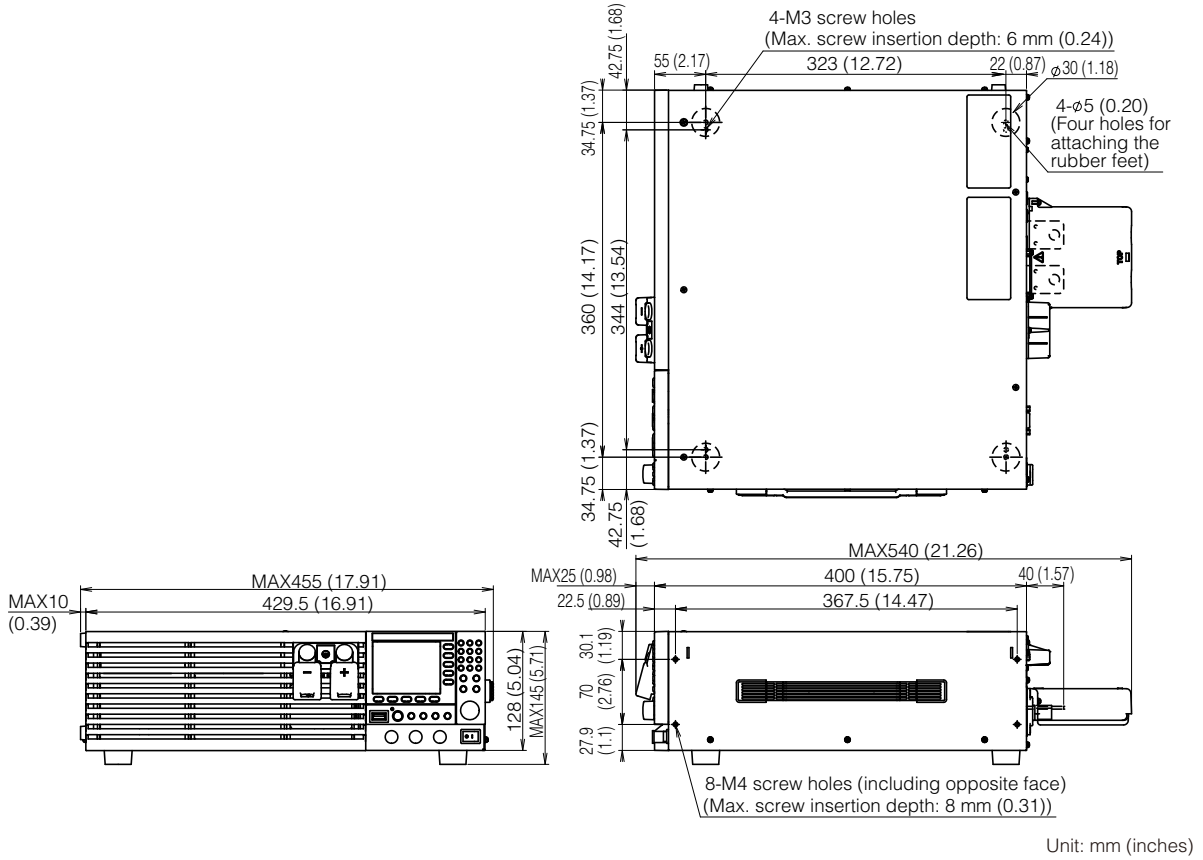



PLZ4005WH2

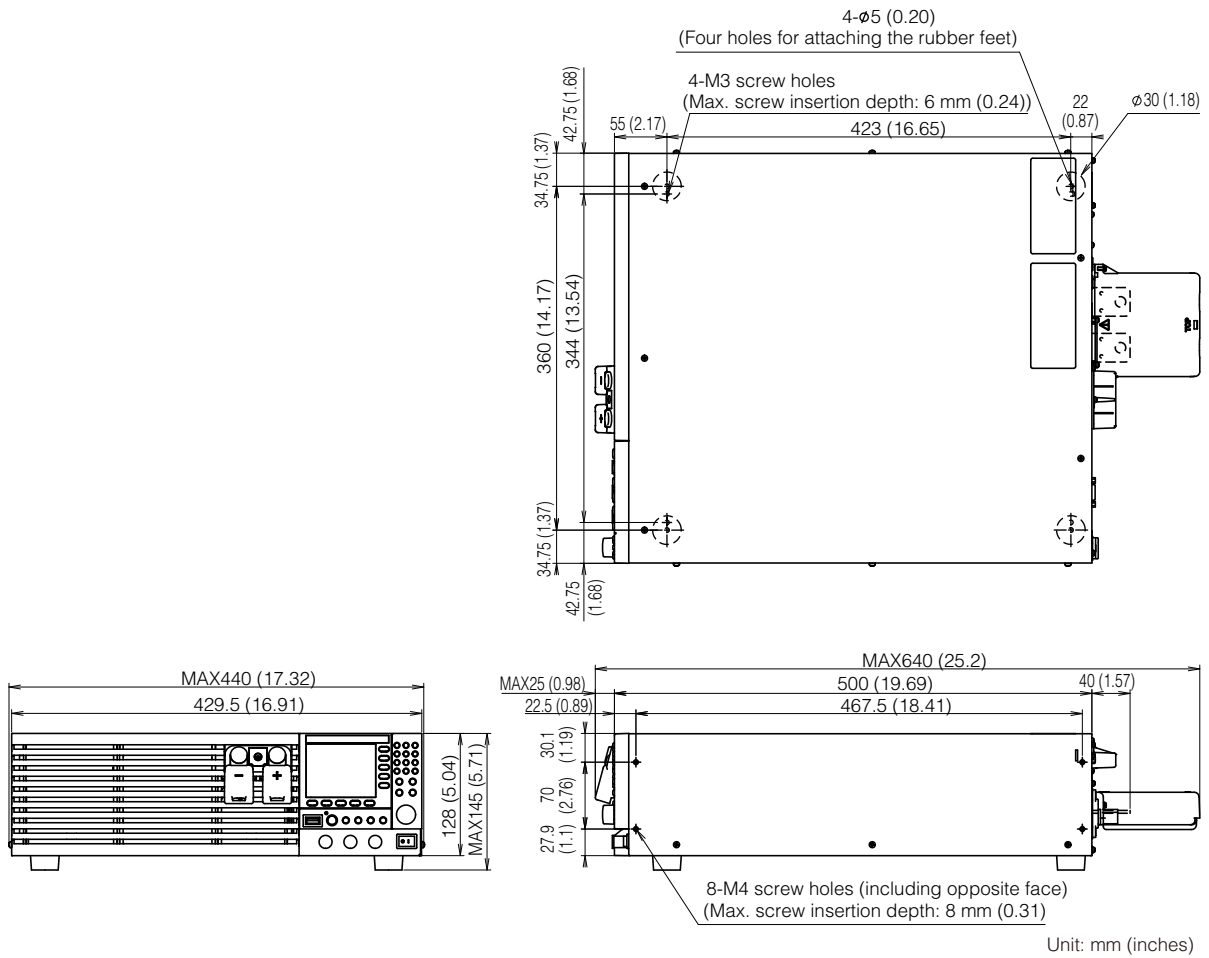

PLZ12005WH2

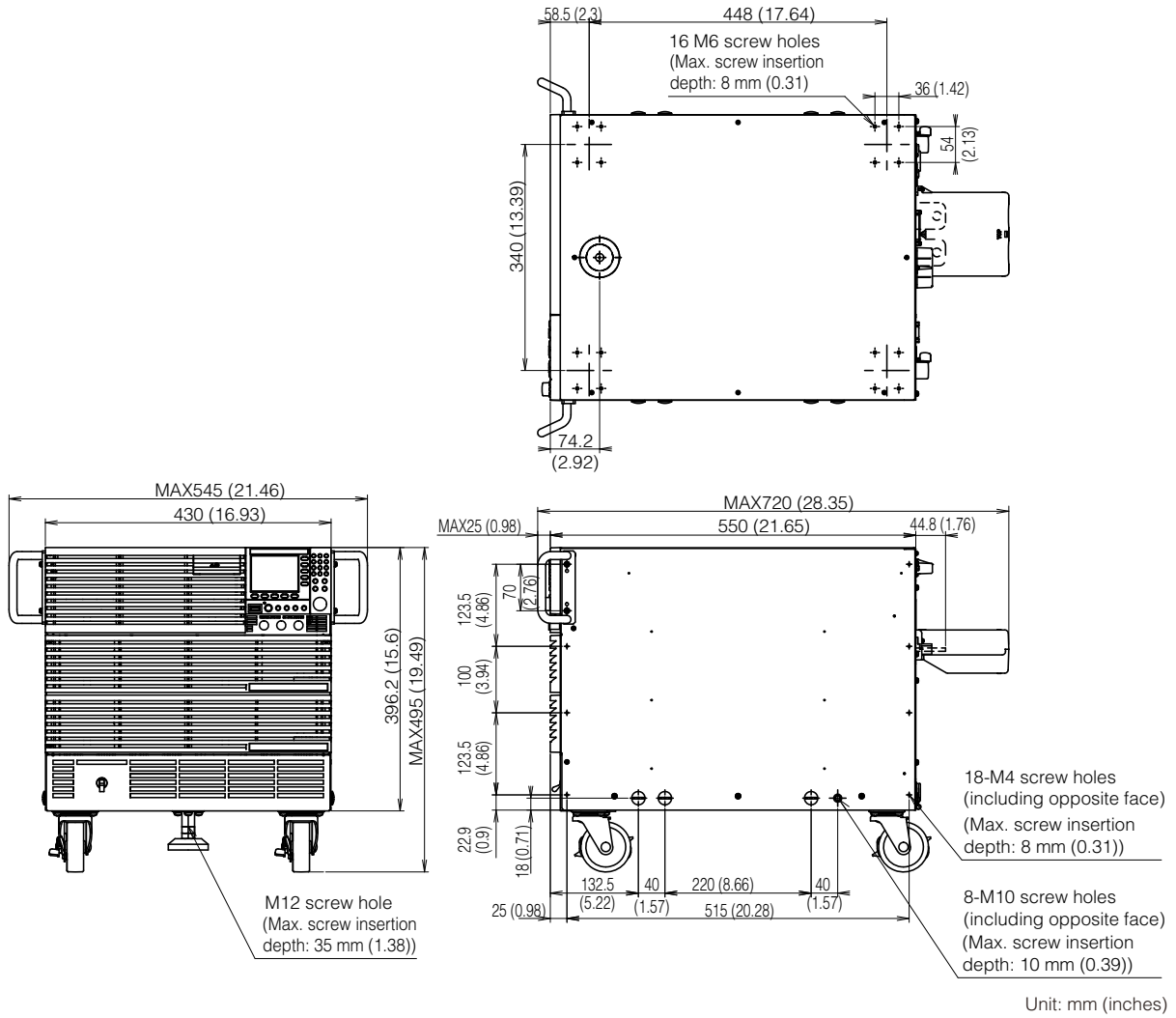

PLZ20005WH2

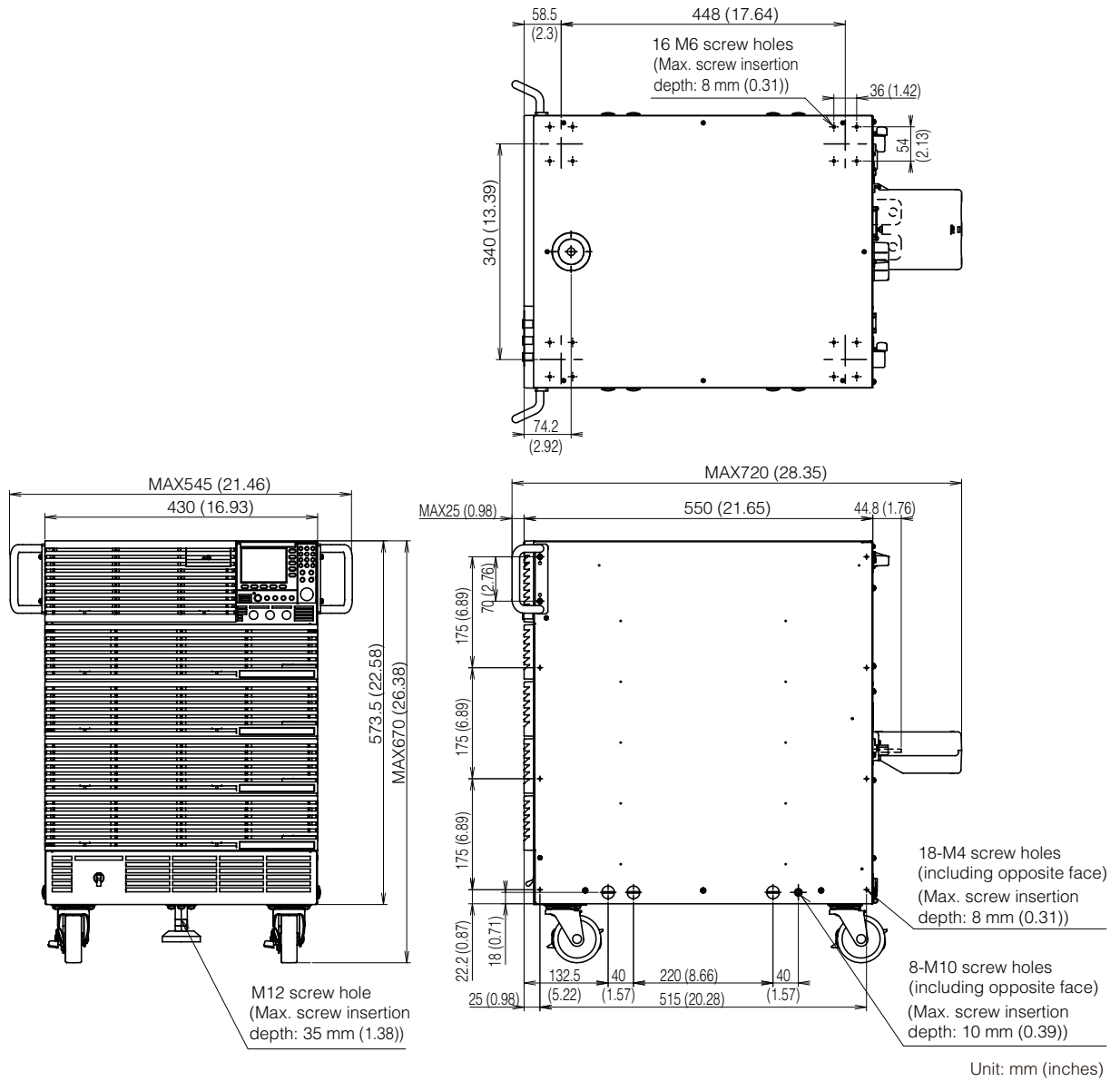

## Selecting the Load Cables

- ⚠ WARNING**
- **Risk of fire. Use load cables whose capacity is adequate for the product's rated input current.**
  - **Risk of electric shock. Use load cables with a voltage rating that meets or exceeds the isolation voltage ( $\pm 1\,000\text{ V}$ ) of the product's DC INPUT terminals.**

**⚠ CAUTION** Use load cables with a core diameter that is appropriate for the amount of current being used and with sturdy, flame-resistant insulation.

### ■ Current capacity of load cables

If the resistance of the cables used as the load cables is large, a large voltage drop may occur when current flows through the cables. This may result in the DC INPUT terminals voltage being lower than the minimum operating voltage of this product. Using the following table as a reference, select wiring whose nominal cross-sectional area is as thick as possible.

A wire's temperature is determined by the resistive loss based on the current, the ambient temperature, and the wire's external thermal resistance. The following table shows the current capacity of heat-resistant vinyl wires that have a maximum allowable temperature of 60 °C when one of the wires is separated and stretched out horizontally in air in an ambient temperature of 30 °C. The current must be reduced under certain conditions, such as when vinyl wires that have a low heat resistance are used, when the ambient temperature is 30 °C or greater, or when wires are bundled together and little heat is radiated.

Nominal cross-sectional area (mm <sup>2</sup> )	AWG	(reference cross-sectional area mm <sup>2</sup> )	Allowable Current <sup>1</sup> [A](Ta = 30 °C)	Kikusui- Recommended Current [A]
14	6	(13.3)	88	50
22	4	(21.15)	115	80
30	2	(33.62)	139	-
38	1	(42.41)	162	100
50	1/0	(53.49)	190	-
60	2/0	(67.43)	217	-
80	3/0	(85.01)	257	200
100	4/0	(107.2)	298	-
125	-	-	344	-
150	-	-	395	300
200	-	-	469	-
250	-	-	556	-
325	-	-	650	-

1. Excerpt from Japanese laws related to electrical equipment.

### ■ Taking measures against noise

When connecting cables that have the same heat resistance, separating the cables as much as possible to increase heat radiation enables a greater amount of current to flow. However, wiring the positive (+) and negative (-) output wires of the load cable side by side or bundling them together is more effective against unwanted noise. The Kikusui-recommended currents shown in the above table are allowable currents that have been reduced in consideration of the potential bundling of load cables. Use these values as a guideline when connecting load cables.

### ■ Limitations of the remote sensing

All wires have resistance. As the cable becomes longer or the current becomes larger, the voltage drop in the cable becomes greater. This results in a smaller voltage being applied at the DC INPUT terminal. Use cables with a large cross-sectional area to keep the DC INPUT terminal voltage from falling below the operating voltage.

# Methods to Stabilize Operation

Using the product at a fast response speed may cause instable oscillation or other operation instability. To achieve stabilization, the load cable inductance must be reduced and an appropriate response speed must be set.

## Reducing the load cable inductance

### Relationship between voltage induction when current is changed and inductance

Load cables have inductance L. If current I changes quickly, a large voltage is induced on both ends of the installed cables. If the impedance of the DUT is small, this voltage is entirely applied to the DC INPUT terminals of the electronic load. The load cable's inductance L and voltage E that is induced according to the changes in current I (hereafter referred to as the induced voltage) are expressed by the following expression:

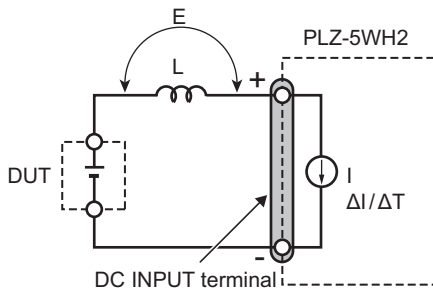

$$E = L \times (\Delta I / \Delta T)$$

- E: Induced voltage
- L: Wiring inductance
- ΔI: Change in current
- ΔT: Duration of time over which the current changes

Generally, a cable's inductance is 1 μH per meter of cable. If 1 meter of cable (cumulative length of positive (+) polarity cable and negative (-) polarity cable) is used as the load cable between the DUT and electronic load, and the current change is 50 A/μs, the induced voltage is 50 V.

In constant voltage mode, constant resistance mode, and constant power mode, the load current is varied by the voltage at the DC INPUT terminals. This causes the operation to be easily affected by induced voltage.

### Preventing large voltage variation when load current changes suddenly

Use the shortest cables possible to connect the product and DUT, and twist the cables. If the cables are too thick to be twisted, bring the DC INPUT terminal's positive and negative terminal cables close together and make them parallel. If the load cable is long or has a large loop, the inductance of the wiring will be increased and large voltage variation will occur owing to current changes when the load current changes suddenly. Keep the voltage resulting from inductance equal to or higher than the minimum operating voltage and within the maximum input voltage range of the product.

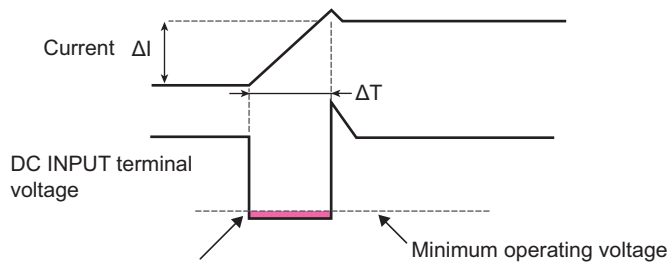

When the value of drops below the minimum operating voltage, the set slew rate is not realized.

When the value of instantaneous voltage of the DC INPUT terminals drops below the minimum operating voltage, the set slew rate is not realized. You must be careful especially when the slew rate setting is high or when changing the load rapidly using large current.

In such a case, reduce the slew rate. If it is not necessary to operate at a high response speed, reduce the slew rate or reduce the response speed in CC mode or CR mode.

## Reducing oscillation caused by phase lag of the current

In CR mode, CV mode, and CP mode, phase lag of the current may cause control of the product to become unstable and oscillation phenomena to occur, even during DC operation. Therefore, use the shortest cables possible and twist them. If the cables are too thick to be twisted, bring the DC INPUT terminal's positive and negative terminal cables close together and make them parallel.

If only DC operation is required, a capacitor and a resistor may be connected to the DC INPUT terminal to reduce oscillation. Use the capacitor within its allowable ripple current.

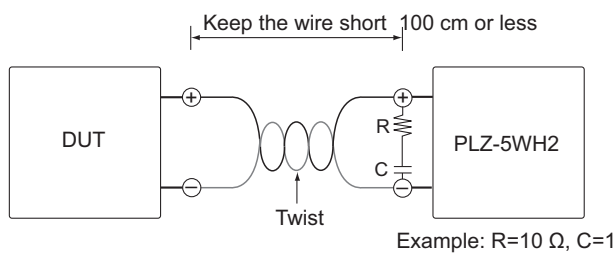

## Optimizing the response speed

The current phase is delayed with respect to the voltage due to the inductance of the wiring. Control of the product may become unstable and oscillation phenomena may occur.

If, in CV mode or CR mode, the response speed is set to Fast, stable operation can be secured by setting the response speed to Normal ([p. 65](#)).

## Using remote sensing

Remote sensing ([p. 67](#)) can be used to stabilize load current. In CP mode the response speed cannot be specified, but the operation can be stabilized by using remote sensing.

# Frequency Derating of Input Voltage

Keep the frequency and amplitude of the voltage applied to the DC Input terminals below the derating curve shown below.

**NOTE** Otherwise, the internal circuit may break.

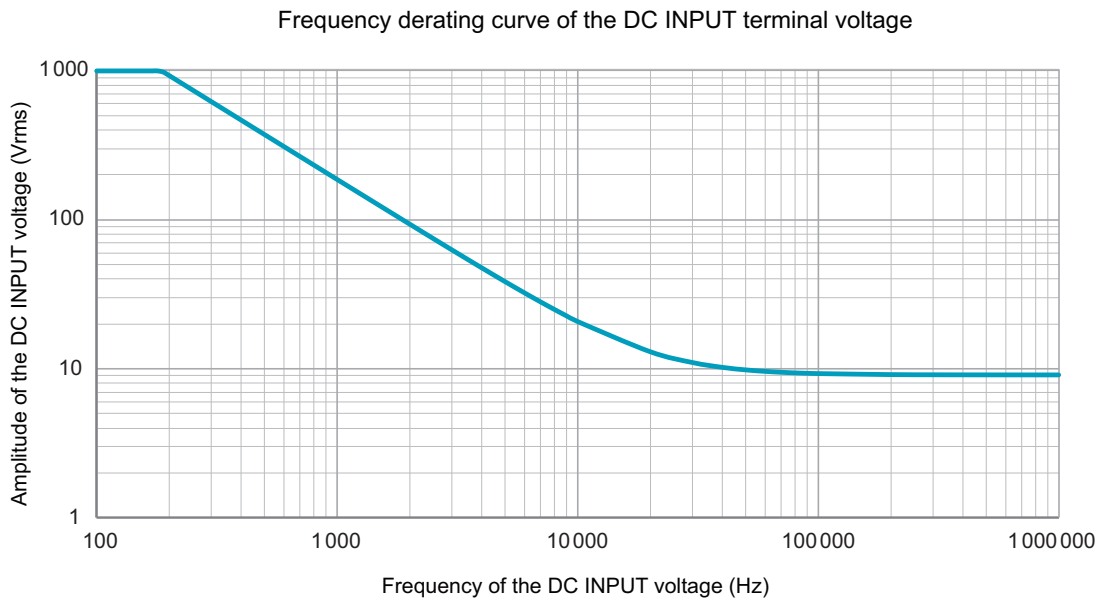



# Slew Rate for Small Currents

If the load current is made small in current (CC) mode, the specified slew rate may not be achieved. The following graph shows the relationship between the set current and the rise/fall time of the actual current when the slew rate is set to 20 A/μs or 2 A/μs.

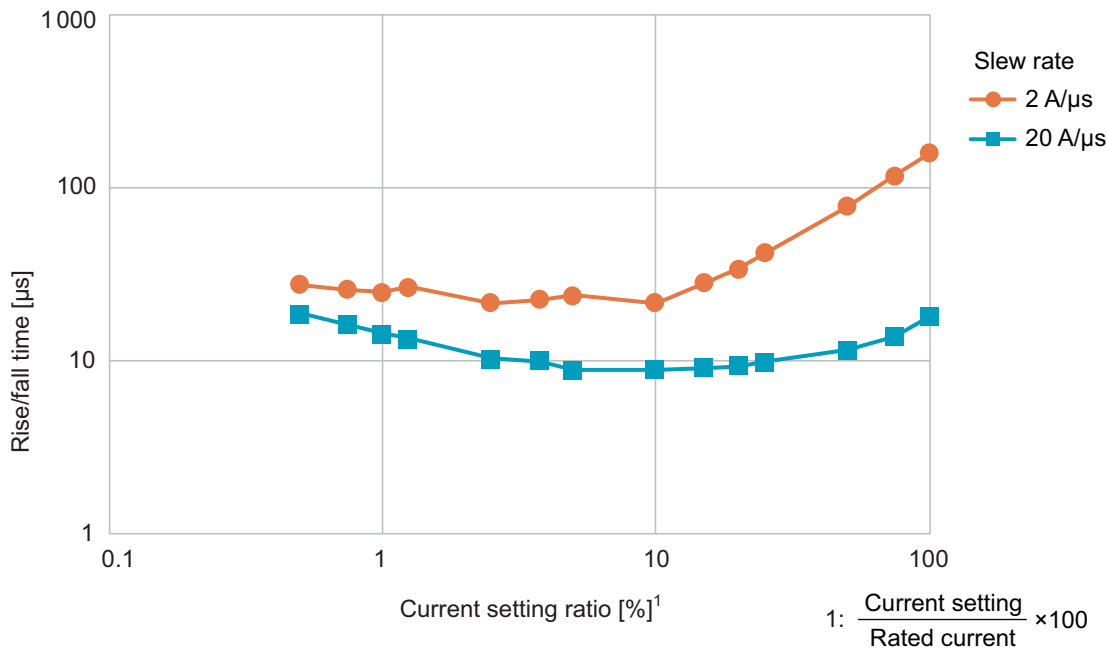

The relationship between the set current and changes in current is shown below.

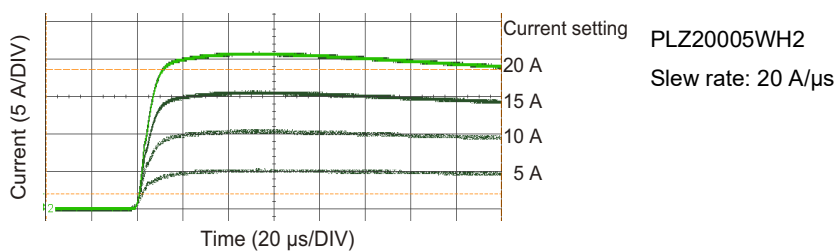
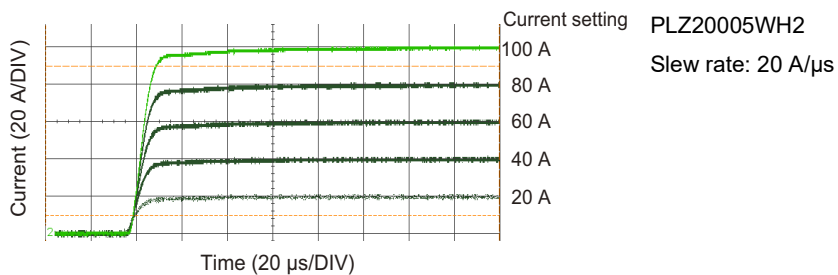
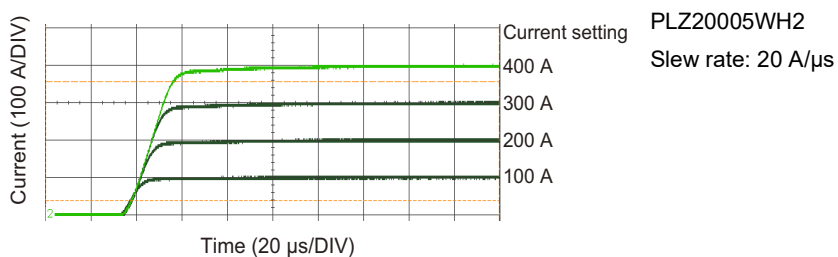

# Operating Area

As shown in the following figure (PLZ12005WH2 example), the product can be used within the area enclosed by the constant voltage line according to the rated voltage (L1), the constant power line according to the rated power (L2), the constant current line according to the rated current (L3), and the constant voltage line according to the minimum operating voltage (L4) (operating area where the specifications are guaranteed). The specifications are guaranteed at input voltages of 10 V and greater, but by reducing the current, operation is possible even with input voltages of less than 10 V (actual operating area). However, the specifications are not guaranteed in that case.

The voltage at which current starts flowing to the product is approximately 1.5 V. If the input voltage is gradually increased from 0 V, no current will flow until the voltage exceeds approximately 1.5 V. If the input voltage exceeds approximately 1.5 V and once a current greater than or equal to 1 % of the current rating starts flowing, the current can be kept flowing even when the input voltage is reduced.

For the operating range of each model, refer to “Operating area of each model” (p. 173).

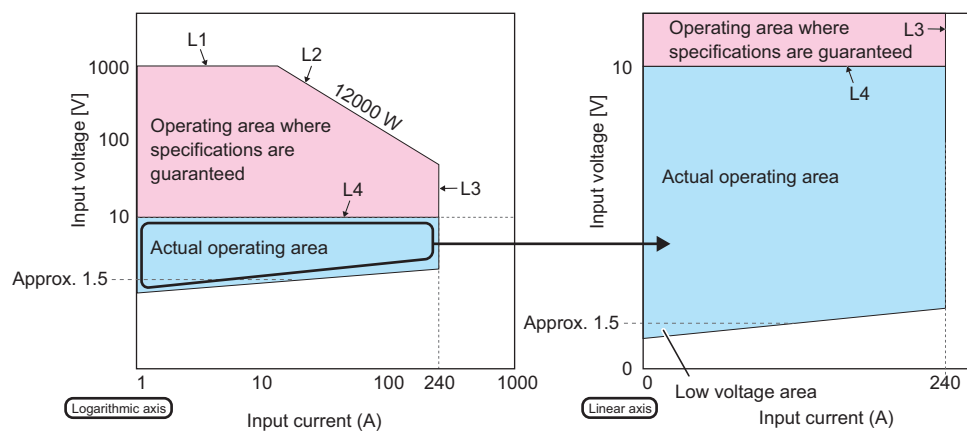

## Basic operation modes

The following five operation modes are available on the product.

- Constant current mode (CC mode)
- Constant resistance mode (CR mode)
- Constant power mode (CP mode)
- Constant voltage mode (CV mode)
- Arbitrary I-V characteristics mode (ARB mode)

## Operation of the constant current (CC) mode

### Operation of the constant current mode

When the product is used in CC mode, it operates as a constant current load as shown in the following figure. The product sinks specified current  $I$  even when output voltage  $V1$  of the constant-voltage power supply changes.

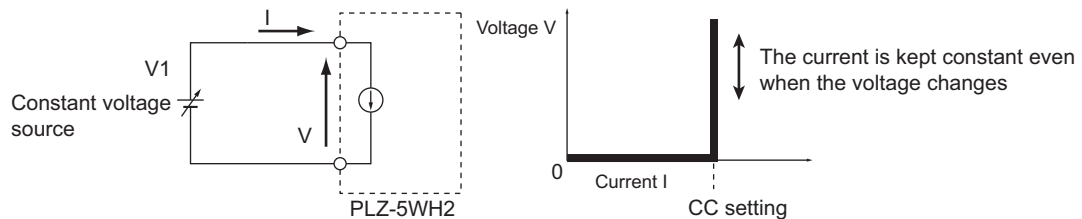

### Transition of the operating point: Overpower protection (OPP) operation

Example: Examining the load characteristics of the constant-voltage power supply in CC mode.

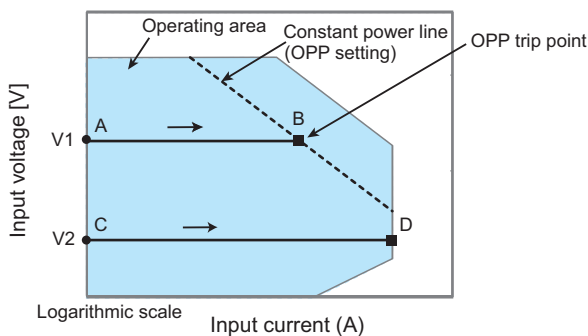

#### ■ Operation on segment AB

If the voltage of the constant-voltage power supply is set to  $V1$  and the input current (load current) of the product is increased, the operating point moves along segment AB. When point B is reached, overpower protection (OPP) is activated. At this point, two types of operation are available on the product depending on which action is set to be executed at OPP detection.

Setup	Behavior
Trip	Turns off the load (stops the current flow).
Limit	The product sinks current as a constant power load at point B. Even if you attempt to increase the input current, the current is limited at point B. If you decrease the input current, the OPP is cleared. The product returns to CC mode and the operating point moves along segment AB.

#### ■ Operation on segment CD

If the voltage of the constant-voltage power supply is set to  $V2$  and the input current (load current) of the product is increased, the operating point moves along segment CD. Point D is maximum current.

## Operation in constant resistance (CR) mode

### Operation in constant resistance mode

When the product is used in CR mode, it operates as a constant resistance load as shown in the following figure. When voltage  $V_1$  of the constant-voltage power supply varies, the product sinks current to maintain  $I = V/R$ , with the specified resistance  $R$  fixed. The product operates by sinking current. This mode cannot be used with an AC circuit.

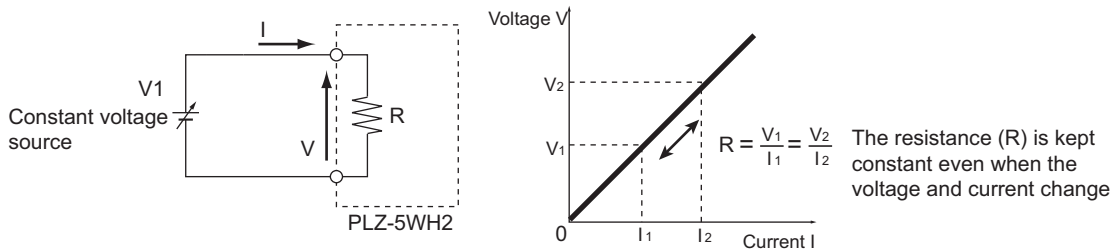

### Transition of the operating point: Overpower protection (OPP) operation

Example: Examining the load characteristics of the constant-voltage power supply in CR mode.

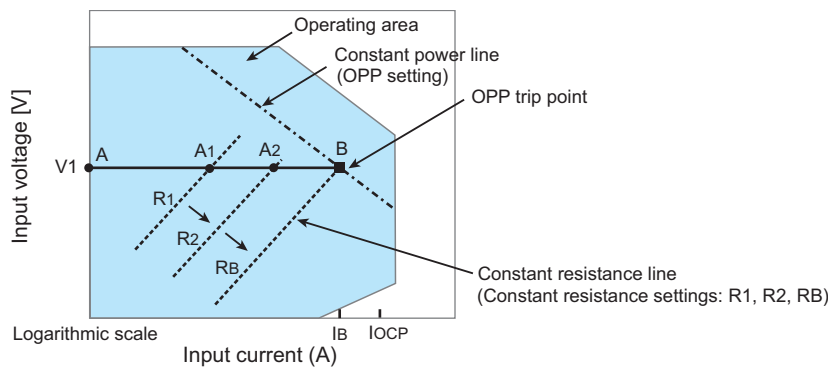

If the overcurrent protection (OCP) setting  $IOCP$  is greater than the current value  $I_B$  at point B, when the product resistance is decreased ( $R_1 \rightarrow R_2 \rightarrow R_B$ ) and the input current (load current) is increased with the voltage of the constant-voltage power supply at  $V_1$ , the operating point moves along segment AB ( $A_1 \rightarrow A_2 \rightarrow B$ ). When point B is reached, OPP is activated. At this point, two types of operation are available on the product depending on which action is set to be executed at OPP detection.

Setup	Behavior
Trip	Turns off the load (stops the current flow).
Limit	The product sinks current as a constant power load at point B. Even if you attempt to increase the input current by decreasing the resistance, the current is limited at point B. If you decrease the input current by increasing the resistance, the OPP is cleared. The product returns to CR mode, and the operating point moves along segment AB.

## Transition of the operating point: Overcurrent protection (OCP) operation

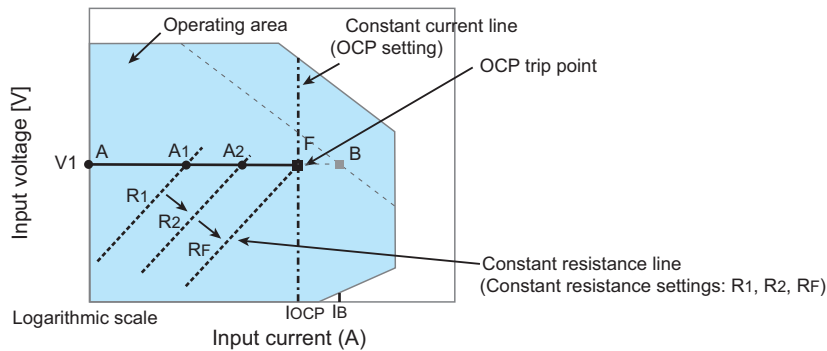

If the OCP setting  $I_{OCP}$  is smaller than the current value  $I_B$  at point B, when the product resistance is decreased ( $R_1 \rightarrow R_2 \rightarrow R_F$ ) and the input current (load current) is increased with the voltage of the constant-voltage power supply at  $V_1$ , the operating point moves along segment AF ( $A_1 \rightarrow A_2 \rightarrow F$ ). When point F is reached, OCP is activated. At this point, two types of operation are available on the product depending on which action is set to be executed at OCP detection.

Setup	Behavior
Trip	Turns off the load (stops the current flow).
Limit	The product sinks current as a constant current load at point F. Even if you attempt to increase the input current by decreasing the resistance, the current is limited at point F. If you decrease the input current by increasing the resistance, the OCP is cleared. The product returns to CR mode, and the operating point moves along segment AF.

## Constant power (CP) mode operation

### Constant power mode operation

When the product is used in CP mode, the product operates as a constant power load as shown in the following figure. When voltage  $V_1$  of the constant-voltage power supply increases, input current  $I$  decreases so that the power consumed by the product,  $P=V \times I$ , is kept constant. In the following figure,  $P = V_1 \times I_1 = V_2 \times I_2$ .

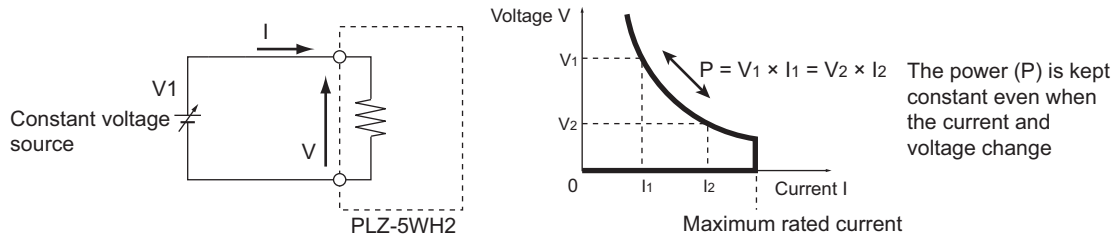

### Transition of the operating point: Overcurrent protection (OCP) operation

Example: Examining the load characteristics of the constant-voltage power supply in CP mode.

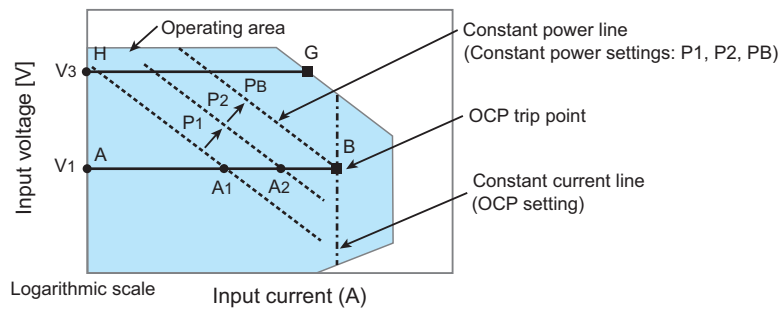

#### ■ Operation on segment AB

If the voltage of the constant-voltage power supply is set to  $V_1$  and the power of the product is increased ( $P_1 \rightarrow P_2 \rightarrow P_B$ ) and the input current (load current) is increased, the operating point moves along segment AB ( $A_1 \rightarrow A_2 \rightarrow B$ ). When point B is reached, OCP is activated. At this point, two types of operation are available on the product depending on which action is set to be executed at OCP detection.

Setup	Behavior
Trip	Turns off the load (stops the current flow).
Limit	The product sinks current as a constant current load at point B. Even if you attempt to increase the input current, the current is limited at point B. If you decrease the input current, the OCP is cleared. The product returns to CP mode and the operating point moves along segment AB.

#### ■ Operation on segment GH

If the voltage of the constant-voltage power supply is set to  $V_3$  and the power of the product is increased ( $P_1 \rightarrow P_2 \rightarrow P_B$ ) and the input current (load current) is increased, the operating point moves along segment GH. Point G is maximum power.

## Constant voltage (CV) mode operation

In CV mode, the product sinks current so that the voltage at the load input end of the product is constant.

### Constant voltage mode operation

When the product is used in CV mode, the product operates as a constant voltage load (shunt regulator) as shown in the following figure. When  $V_1$  is greater than  $V$ , input voltage  $V$  is kept constant even when input current  $I$  varies. Current does not flow when  $V_1$  is less than or equal to  $V$ . The product may operate unstably if  $R_1$  is low.

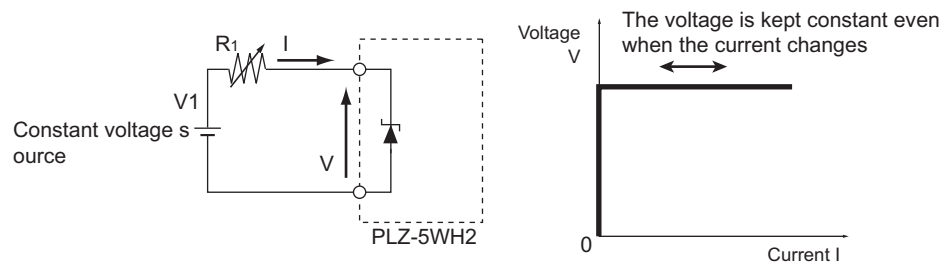

### Transition of the operating point: Overpower protection (OPP) operation

Example: Examining in CV mode the load characteristics of the power supply with a large internal resistance

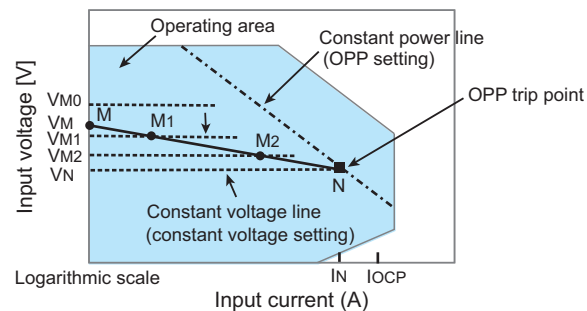

We assume that the overcurrent protection setting  $IOCP$  is greater than current  $IN$  at point  $N$  and denote the voltage of the constant voltage power supply as  $VM$ . When voltage  $VM_0$  of the product is greater than  $VM$ , no current flows. When the voltage of the product is decreased to a point where  $VM_0$  is smaller than  $VM$ , the current starts flowing. If the voltage is decreased further ( $VM_1 \rightarrow VM_2 \rightarrow VN$ ) to increase the input current (load current), the operating point moves along segment  $MN$  ( $M_1 \rightarrow M_2 \rightarrow N$ ). When point  $N$  is reached, OPP is activated. At this point, two types of operation are available on the product depending on which action is set to be executed at OPP detection.

Setup	Behavior
Trip	Turns off the load (stops the current flow).
Limit	The product sinks current as a constant power load at point $N$ . Even if you attempt to decrease the voltage, the current is limited at point $N$ . If you increase the voltage, the OPP is cleared. The product returns to CV mode and the operating point moves along segment $MN$ .

### Transition of the operating point: Overcurrent protection (OCP) operation

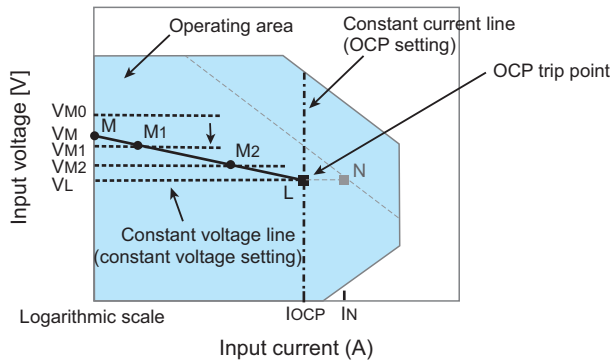

We assume that OCP setting IOCP is smaller than current IN at point N and denote the voltage of the constant voltage power supply as VM. When voltage VM0 of the product is greater than VM, no current flows. When the voltage of the product is decreased to a point where VM0 is smaller than VM, the current starts flowing. If the voltage is decreased further (VM1 → VM2 → VL) to increase the input current (load current), the operating point moves along segment ML (M1 → M2 → L). When point L is reached, OCP is activated. At this point, two types of operation are available on the product depending on which action is set to be executed at OCP detection.

Setup	Behavior
Trip	Turns off the load (stops the current flow).
Limit	The product sinks current as a constant current load at point L. Even if you attempt to decrease the voltage current, the current is limited at point L. If you increase the voltage, the OCP is cleared. The product returns to CV mode and the operating point moves along segment ML.



## Operating area of each model

### Operating area of the PLZ1005WH2

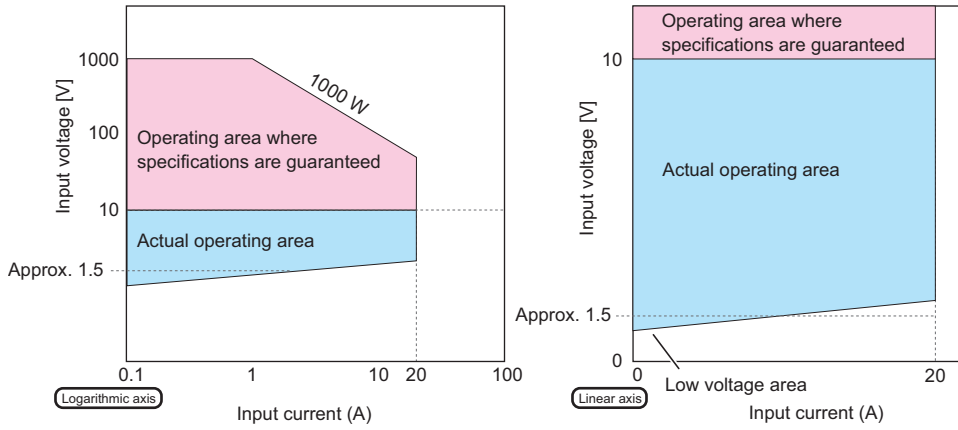

### Operating area of the PLZ2005WH2

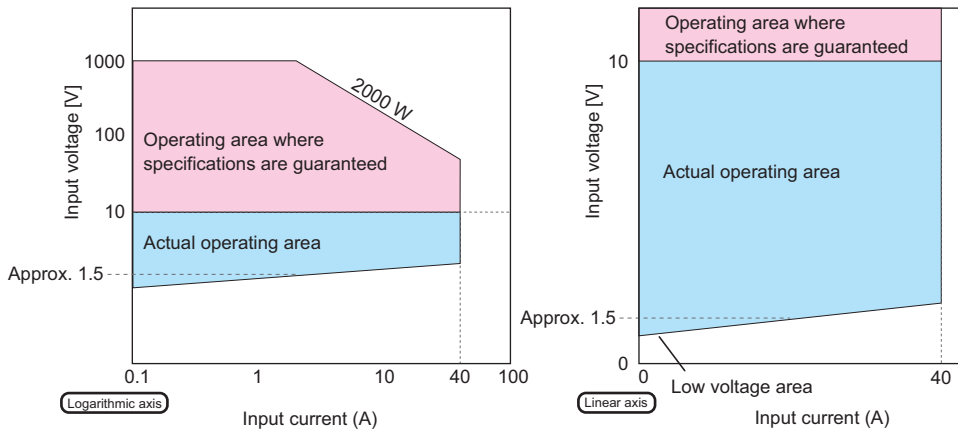

### Operating area of the PLZ4005WH2

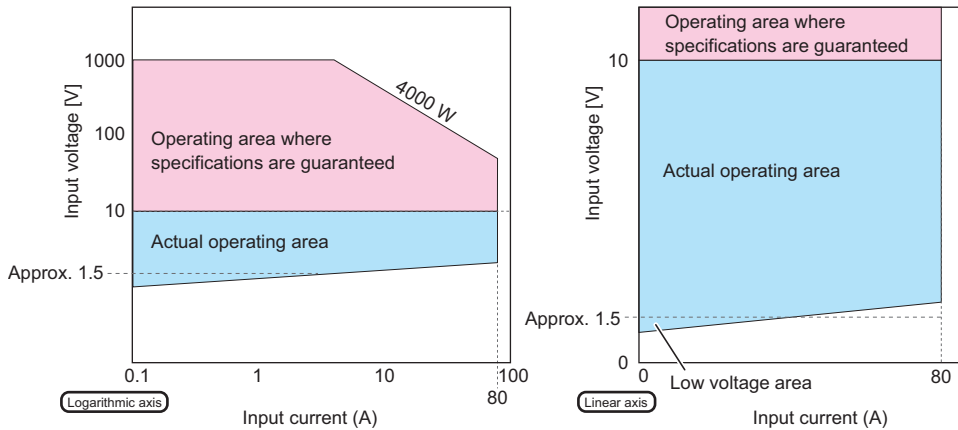

### Operating area of the PLZ12005WH2

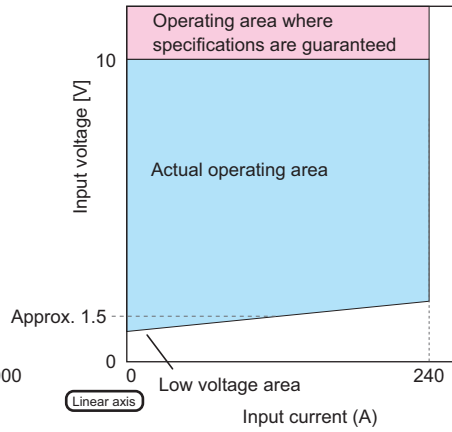
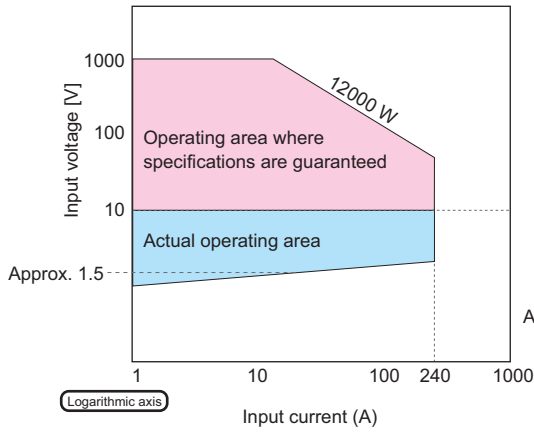

### Operating area of the PLZ20005WH2

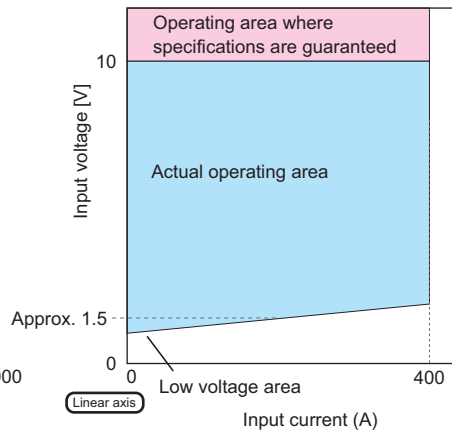
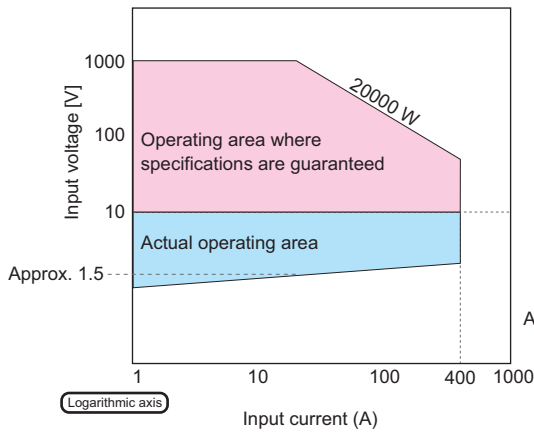

# OPP Operation

This section explains the current limit and response time until OPP is activated in the voltage and current waveforms when OPP is activated.

## Current limit in relation to the voltage

This product can capture the power instantaneously even when the load power is exceeding the rated power until OPP is activated. However, the current is limited in relation to the voltage across the DC Input terminals. The following graph shows the relationship between the current and power in relation to the voltage across the DC INPUT terminals.

For example, if the DC INPUT terminal voltage is 100 V, the power can be captured instantaneously up to 200 % of the rated power. In this situation, the current flow can be increased up to the rated current.

If the DC INPUT terminal voltage is 500 V, the power can be captured instantaneously up to 600 % of the rated power. In this situation, the current is limited to 60 % of the rated current.

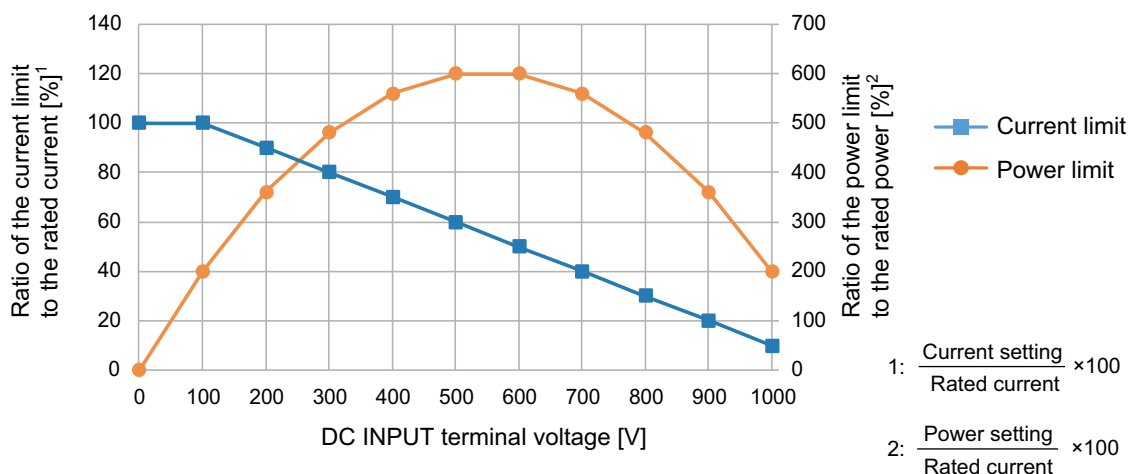

## Response time

The OPP response time varies depending on the amplitude of the load power and the amplitude of the load current exceeding the OPP setting.

The following graph shows the relationship between the duration of time until OPP (Limit) is activated and the DC INPUT terminal voltage in CC mode.

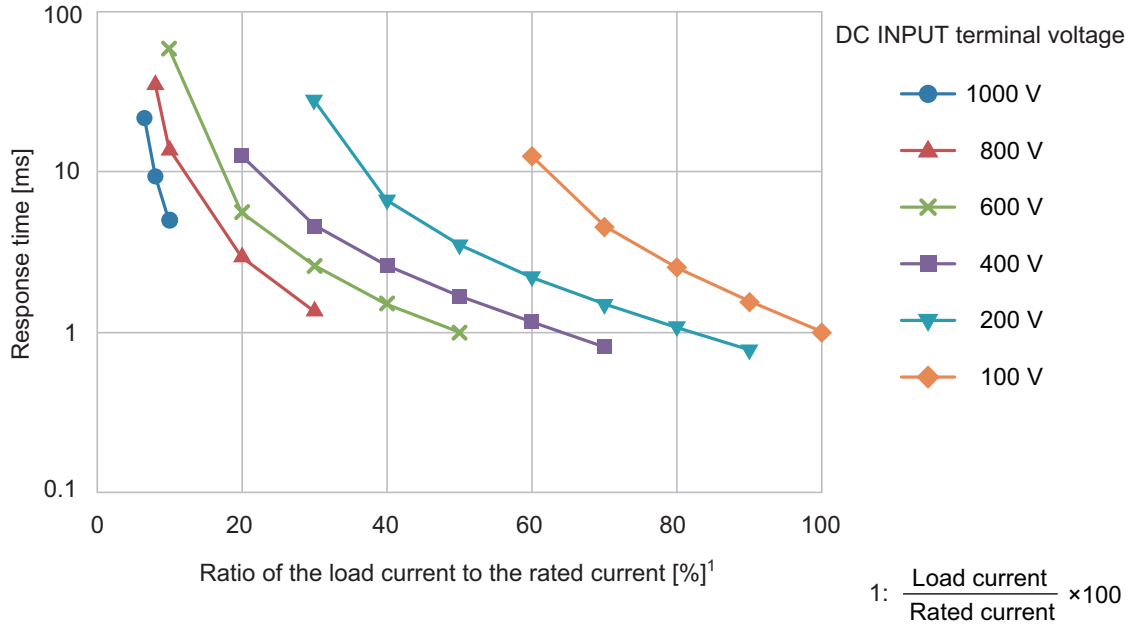

## Waveform

The following figures show the waveforms when the action to be taken when OPP is activated is set to Limit (OPPL). (for PLZ2005WH2)

### ■ Load power 11300 W

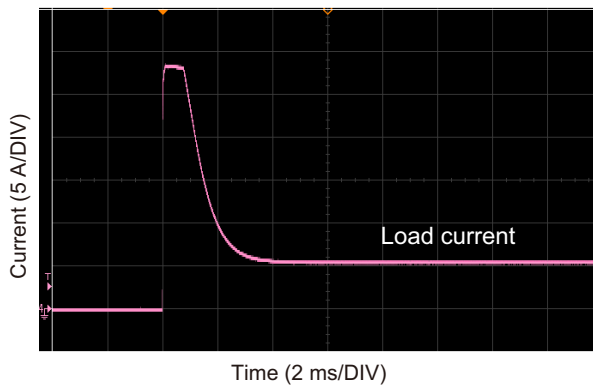

■ Measurement conditions  
 Operation mode: CC  
 Load current: 0 A→28 A  
 DC INPUT terminal voltage: 400 V

### ■ Load power 9700 W

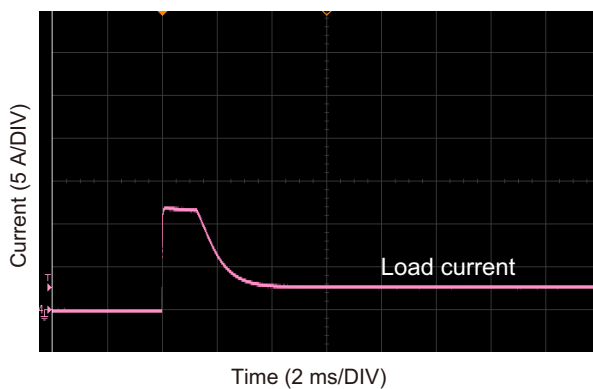

■ Measurement conditions  
 Operation mode: CC  
 Load current: 0 A→12 A  
 DC INPUT terminal voltage: 800 V

### ■ Load power 4000 W

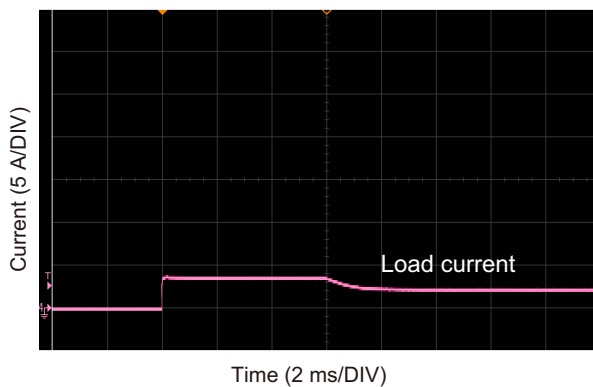

■ Measurement conditions  
 Operation mode: CC  
 Load current: 0 A→4 A  
 DC INPUT terminal voltage: 1000 V

# Propagation Delay for External Control

The following figure shows the propagation delays of the changes in the load current with respect to external control and the changes in the current monitor voltage with respect to changes in the load current.

## External input voltage (EXT CONT) vs. load current

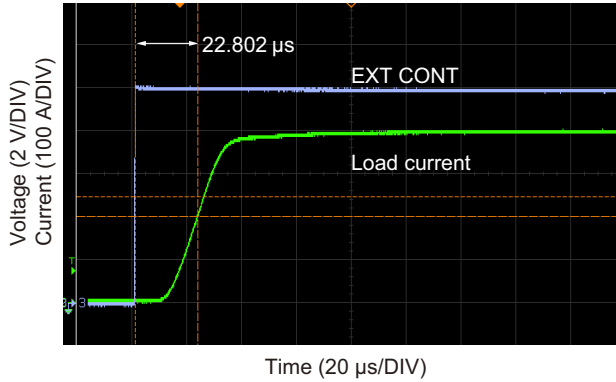

### Measurement conditions

Operation mode: CC

Load current: 0 A→400 A

DC INPUT terminal voltage: 50 V

Slew rate: 20 A/μs

EXT CONT signal (external input voltage): 0 V → 10 V

## Load current vs. current monitor voltage (I MON OUT)

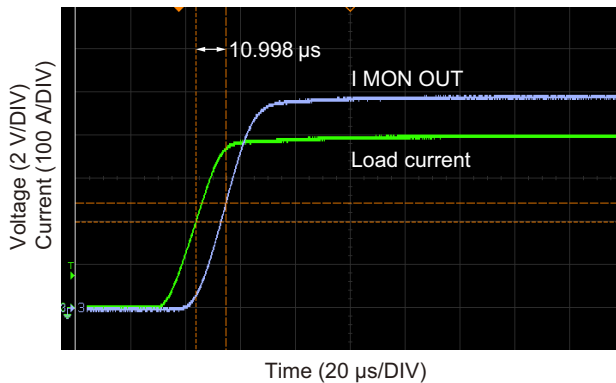

### Measurement conditions

Operation mode: CC

Load current: 0 A→400 A

DC INPUT terminal voltage: 50 V

Slew rate: 20 A/μs

# Operating Range during Parallel Operation

The operating range during parallel operation using the same model is shown for each operation mode.

## CC mode

### ■ Operating range

Number of slaves	PLZ1005WH2	PLZ2005WH2	PLZ4005WH2	PLZ12005WH2	PLZ20005WH2
1	0 A to 40 A	0 A to 80 A	0 A to 160 A	0 A to 480 A	0 A to 800 A
2	0 A to 60 A	0 A to 120 A	0 A to 240 A	0 A to 720 A	0 A to 1200 A
3	0 A to 80 A	0 A to 160 A	0 A to 320 A	0 A to 960 A	0 A to 1600 A
4	0 A to 100 A	0 A to 200 A	0 A to 400 A	0 A to 1200 A	0 A to 2000 A

### ■ Slew rate

Number of slaves	PLZ1005WH2	PLZ2005WH2	PLZ4005WH2
1	0.002 A/ $\mu$ s to 2 A/ $\mu$ s	0.004 A/ $\mu$ s to 4 A/ $\mu$ s	0.008 A/ $\mu$ s to 8 A/ $\mu$ s
2	0.003 A/ $\mu$ s to 3 A/ $\mu$ s	0.006 A/ $\mu$ s to 6 A/ $\mu$ s	0.012 A/ $\mu$ s to 12 A/ $\mu$ s
3	0.004 A/ $\mu$ s to 4 A/ $\mu$ s	0.008 A/ $\mu$ s to 8 A/ $\mu$ s	0.016 A/ $\mu$ s to 16 A/ $\mu$ s
4	0.005 A/ $\mu$ s to 5 A/ $\mu$ s	0.010 A/ $\mu$ s to 10 A/ $\mu$ s	0.020 A/ $\mu$ s to 20 A/ $\mu$ s

Number of slaves	PLZ12005WH2	PLZ20005WH2
1	0.02 A/ $\mu$ s to 24 A/ $\mu$ s	0.04 A/ $\mu$ s to 40 A/ $\mu$ s
2	0.03 A/ $\mu$ s to 36 A/ $\mu$ s	0.06 A/ $\mu$ s to 60 A/ $\mu$ s
3	0.04 A/ $\mu$ s to 48 A/ $\mu$ s	0.08 A/ $\mu$ s to 80 A/ $\mu$ s
4	0.05 A/ $\mu$ s to 60 A/ $\mu$ s	0.1 A/ $\mu$ s to 100 A/ $\mu$ s

## CR mode

### ■ Operating range

Number of slaves	PLZ1005WH2		PLZ2005WH2		PLZ4005WH2	
	H range	L range	H range	L range	H range	L range
1	1.0 S to 0 S	10 mS to 0 S	2 S to 0 S	20 mS to 0 S	4 S to 0 S	200 mS to 0 S
2	1.5 S to 0 S	15 mS to 0 S	3 S to 0 S	30 mS to 0 S	6 S to 0 S	300 mS to 0 S
3	2.0 S to 0 S	20 mS to 0 S	4 S to 0 S	40 mS to 0 S	8 S to 0 S	400 mS to 0 S
4	2.5 S to 0 S	25 mS to 0 S	5 S to 0 S	50 mS to 0 S	10 S to 0 S	500 mS to 0 S

Number of slaves	PLZ12005WH2		PLZ20005WH2	
	H range	L range	H range	L range
1	12 S to 0 S	120 mS to 0 S	20 S to 0 S	200 mS to 0 S
2	18 S to 0 S	180 mS to 0 S	30 S to 0 S	300 mS to 0 S
3	24 S to 0 S	240 mS to 0 S	40 S to 0 S	400 mS to 0 S
4	30 S to 0 S	300 mS to 0 S	50 S to 0 S	500 mS to 0 S

## CV mode

### ■ Operating range

Number of slaves	All models
1 to 4	10 V to 1000 V

## CP mode

### ■ Operating range

Number of slaves	PLZ1005WH2	PLZ2005WH2	PLZ4005WH2	PLZ12005WH2	PLZ20005WH2
1	0 W to 2 kW	0 W to 4 kW	0 W to 8 kW	0 W to 24 kW	0 W to 40 kW
2	0 W to 3 kW	0 W to 6 kW	0 W to 12 kW	0 W to 36 kW	0 W to 60 kW
3	0 W to 4 kW	0 W to 8 kW	0 W to 16 kW	0 W to 48 kW	0 W to 80 kW
4	0 W to 5 kW	0 W to 10 kW	0 W to 20 kW	0 W to 60 kW	0 W to 100 kW



# Options

This product has the following options.  
For information about options, contact your Kikusui agent or distributor.

## Parallel operation signal cable kit

This kit contains a signal cable for performing parallel operation on the PLZ-5WH2 series.

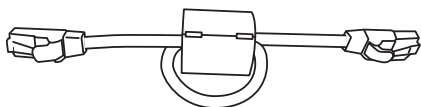

Model	Cable length
PC01-PLZ-5W	Approx. 30 cm
PC02-PLZ-5W	Approx. 1 m

## Low inductance cable

This is a load cable with suppressed inductance. It suppresses voltage drops that occur when current fluctuations are fast.

## High-voltage load cable

This load cable supports high voltage. Up to 80 A (Kikusui-recommended current) is supported.

## GPIB converter (PIA5100)

This converter converts RS232C or USB of the product to GPIB, enabling connection of a remote controller using GPIB. Perform the connection as shown below.

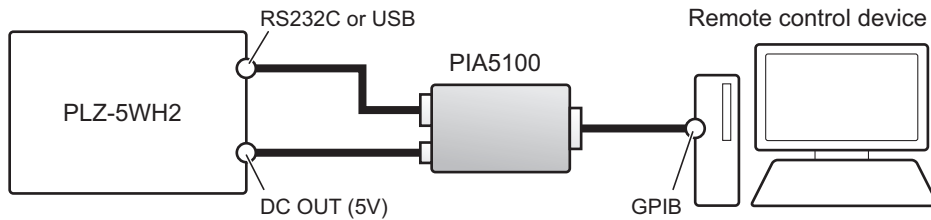

The GPIB communication specifications are as follows.

Item	Specifications
Hardware	Complies with IEEE Std 488.1-1987 SH1, AH1, T6, L4, SR1, PP0, DC1, DT1, C0, E1
Message terminator	LF or EOI during reception, LF + EOI during transmission
Primary address	0 to 30

When you connect a PIA5100, you cannot use the product's RS232C or USB port.

Some restrictions apply to the GPIB functions that can be used with the PIA5100. When connected through RS232C, the product supports the KISTD SAFU protocol.

For details, see the GPIB converter (PIA5100) operation manual.

## Rack mount bracket

These are rack mounting options.

Appropriate Model	Model	Description
PLZ1005WH2	KRB3-TOS	For EIA inch racks
PLZ2005WH2	KRB150-TOS	For JIS millimeter racks
PLZ4005WH2		
PLZ12005WH2	KRB9	For EIA inch racks
	KRB400-PCR-LE	For JIS millimeter racks
PLZ20005WH2	KRB13	For EIA inch racks
	KRB600	For JIS millimeter racks

To rack mount the product, remove the casters and the stopper.

### Outline drawing

#### ■ PLZ1005WH2, PLZ2005WH2, PLZ4005WH2

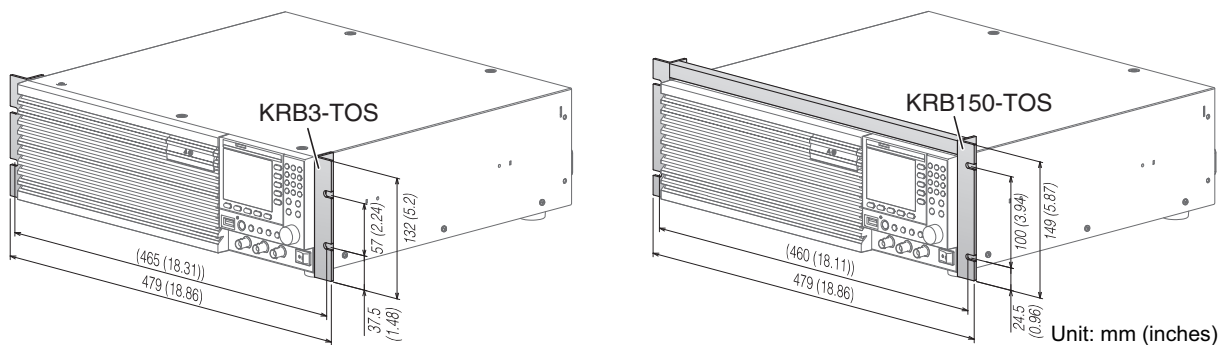

#### ■ PLZ12005WH2

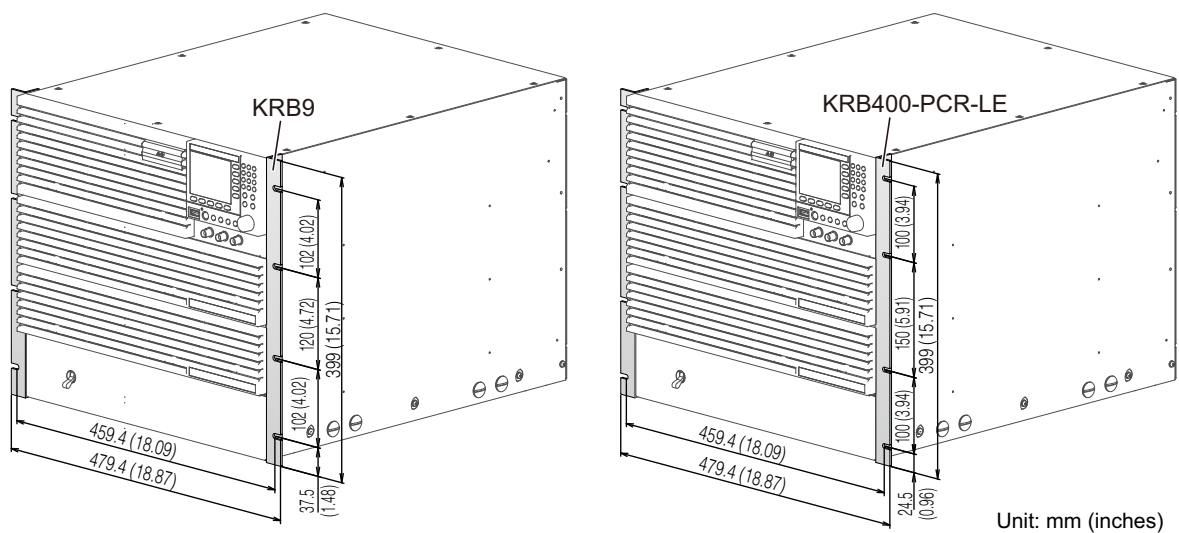

■ PLZ2005WH2

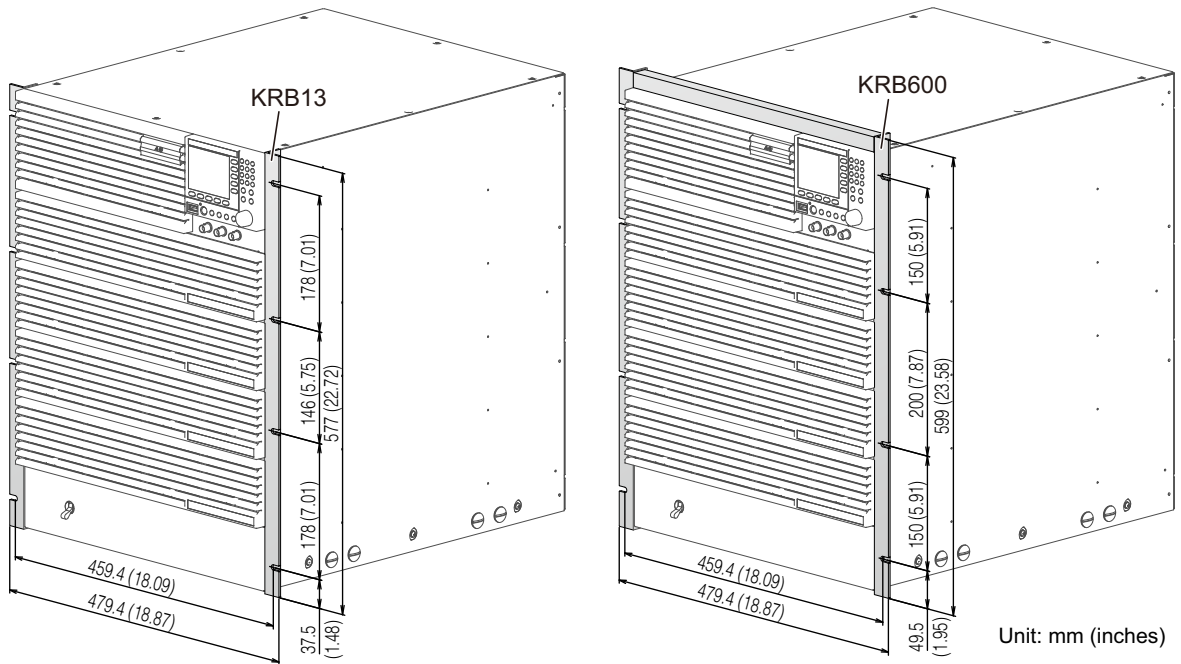

**Preparation for rack mount bracket attachment**

To attach the product's rack mount bracket, remove components such as the handle, legs, and casters. For information on rack mounting, see the operation manual of the rack mount bracket.

**NOTE**

We recommend that you keep all pieces that you remove from the product. You will need these pieces if you remove the product from the rack.

■ PLZ1005WH2, PLZ2005WH2, PLZ4005WH2

Side panel legs and handle are attached only to the PLZ1005WH2 and PLZ2005WH2.

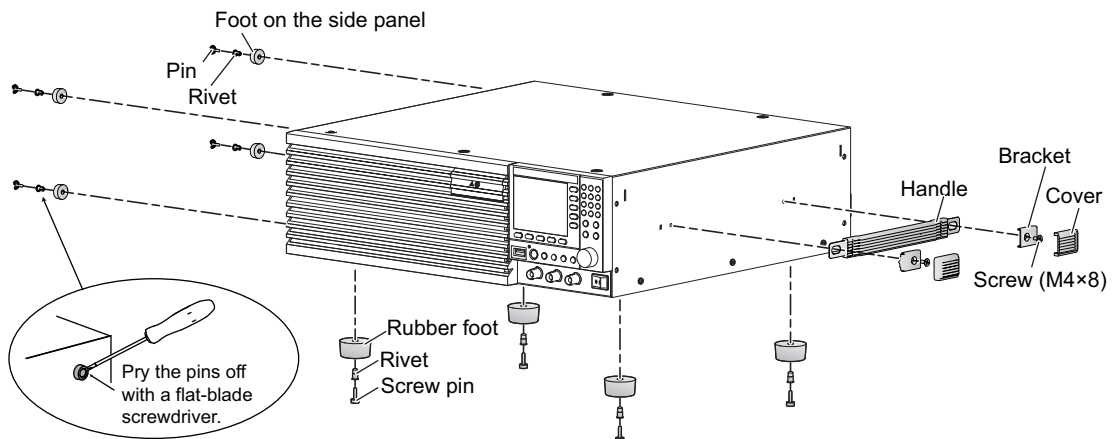

**1** Remove the two handle covers.

- 2** Unfasten the two screws, and remove the entire handle.
- 3** While pulling down the rubber feet (four locations) of the bottom panel, loosen their screw pin with a screwdriver and remove the feet.
- 4** Unfasten the internal pins from the rubber feet (four locations) of the side panel using a flat-blade screwdriver, and then remove the feet.  
This completes the removal.

**NOTE**

To reinstall the handle that has been removed, use screw locking agent (e.g., 1401B by ThreeBond International, Inc.) to prevent screws from loosening.

■ **PLZ12005WH2, PLZ20005WH2**

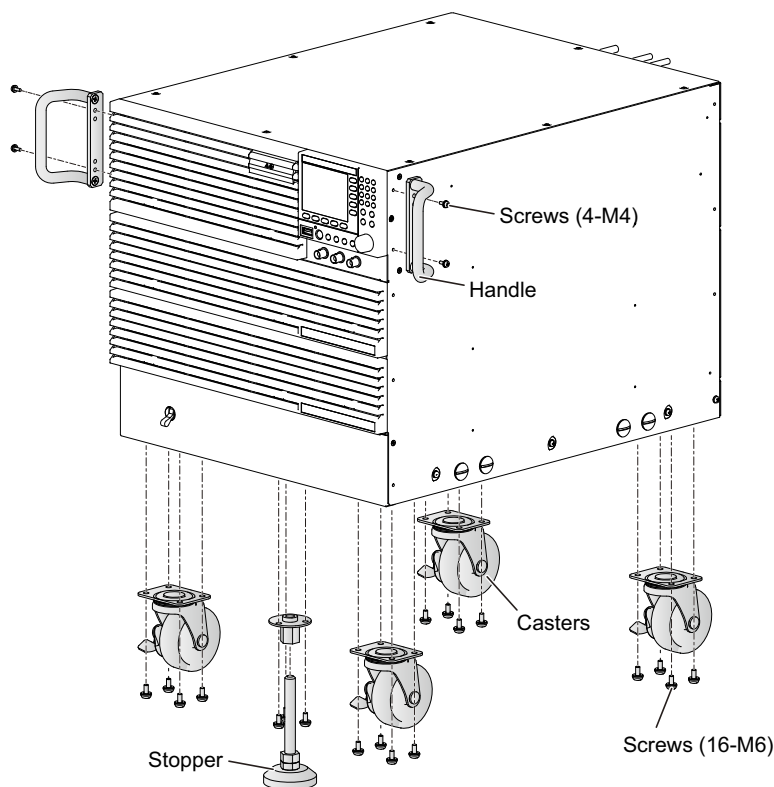

- 1** While pulling down the stopper (one location) of the bottom panel, loosen the screws with a screwdriver and remove it.
- 2** While pulling down the casters (four location) of the bottom panel, loosen the screws with a screwdriver and remove it.
- 3** While pulling the handles (two location) of the side panel toward you, loosen the screws with a screwdriver and remove it.

# Troubleshooting

This section introduces troubleshooting measures. Typical symptoms are listed. Check whether any of the items listed below apply to your case. In some cases, the problem can be solved quite easily.

If none of the items apply to your case, we recommend that you initialize the product to its factory default settings (p. 137). If following the remedy does not solve your problem, contact your Kikusui agent or distributor.

## ■ Nothing appears on the display when the POWER switch is turned on.

Check	Possible cause	Remedy
Is the rated voltage being applied to the input power supply (AC)?	Broken power cord. Bad connection at the rear-panel AC INPUT connector.	Check that the power cord is not broken and that the connection at the AC INPUT connector is secure.

## ■ Keys do not work.

Check	Possible cause	Remedy
Are the keys locked? (🔒/🔓) 🔒 is shown on the display)	The key lock is enabled (p. 129).	Hold down KEY LOCK to release the key lock.
The remote icon (Remote) is shown on the display.	Panel control is not possible because remote control is in progress.	Press ESCAPE to enable panel control.

## ■ Input current is unstable or oscillates.

Check	Possible cause	Remedy
Is the rated voltage being applied to the input power supply (AC)?	Low supply voltage.	Use the product in the input supply voltage range.
Is an alarm occurring?	There is an internal or external error.	Check the type of alarm, and eliminate the root cause of the alarm. (p. 48).
Is there a large loop in the load cable?	The wire inductance has increased.	Twist the wires. See “Preventing large voltage variation when load current changes suddenly” (p. 162).
Does the behavior change depending on the length of the wiring?	A proper response speed is not being used.	Change the response speed (p. 65).

## ■ An alarm is occurring.

Check	Possible cause	Remedy
Has overheat detection (OTP) been activated?	The fan has stopped.	Immediately stop using the product, and have it repaired.
	Vent or inlet holes are blocked.	Move the product so that there is at least 75 cm of space between the vents and the surrounding walls. Do not place objects within 75 cm of the vents.
Has overcurrent protection (OCP) been activated?	The OCP setting is small.	Set an appropriate OCP value on the setup screen (p. 50).
Has overpower protection (OPP) been activated?	The OPP setting is small.	Set an appropriate OPP value on the setup screen (p. 51).

### ■ The load cannot be turned on.

Check	Possible cause	Remedy
A sequence is in operation.	The load cannot be turned on manually when a sequence is in operation.	Wait for the sequence operation to finish. Abort the sequence by pressing the Abort key ( <a href="#">p. 104</a> ).
Is the load on/off logic (Input Logic) set to Negative?	The logic is incorrect.	Set Input Logic to Positive ( <a href="#">p. 115</a> ).
Are you using an external signal to turn the load off?	When the load is turned off through external control, the LOAD key is invalid.	The load key will be valid after you use an external signal to turn the load on ( <a href="#">p. 115</a> ).
The cutoff cause icon (TIME, VOLT, CAP, ENER) is shown on the display.	The cutoff function is satisfying the condition for turning the load off.	Set the cutoff to Disable ( <a href="#">p. 70</a> ).

### ■ The load suddenly turns off.

Check	Possible cause	Remedy
The cutoff cause icon (TIME, VOLT, CAP, ENER) is shown on the display.	The cutoff function is satisfying the condition for turning the load off.	Set the cutoff to Disable ( <a href="#">p. 70</a> ).

### ■ External control (CC/CR/CP) cannot be set.

Check	Possible cause	Remedy
The pulse function is on.	Cannot be used simultaneously with the pulse function.	Turn off the pulse function ( <a href="#">p. 44</a> ).
The sine function is on.	Cannot be used simultaneously with the sine function.	Turn off the sine function ( <a href="#">p. 47</a> ).

### ■ Pulse function of sine function cannot be set.

Check	Possible cause	Remedy
External control (CC/CR/CP) is on.	Cannot be used simultaneously with the external control (CC/CR/CP).	Turn off the external control (CC/CR/CP) ( <a href="#">p. 112</a> ).
A sequence is running.	Cannot be used simultaneously with a running sequence.	Abort the sequence ( <a href="#">p. 104</a> ).

# Index

## A

ABC preset memories.....	75
accessories.....	3
alarm	
occurrence.....	54
type.....	48
alarms	
clearing.....	54
ARB mode.....	37
arbitrary I-V characteristics mode.....	37

## B

battery replacement.....	144
beep sound.....	130

## C

calibration.....	144
CC mode.....	32, 167
CLEAR key.....	28
communication function.....	154
component names.....	10
conductance.....	33
constant current mode.....	32, 167
constant power mode.....	36, 170
constant resistance mode.....	33, 168
constant voltage mode.....	35, 171
CP mode.....	36, 170
CR mode.....	33, 168
current/voltage monitor signal.....	120
Cursor keys.....	28
cutoff function.....	70
CV mode.....	35, 171

## D

date/time setting.....	136
DC INPUT terminal cover.....	21
DC INPUT terminals.....	15, 20, 22
DC OUT 5V.....	182
default settings.....	132, 139
device information.....	143
digital I/O.....	119
DIGITAL0.....	119
DIGITAL1.....	119
DIGITAL2.....	119, 131
display.....	13
DUT.....	19

## E

elapsed time display.....	63
ESCAPE key.....	28
EXT CONT connector.....	109, 110
EXT SYNC port.....	83
external control.....	108
external dimensions.....	156

## F

factory default settings.....	132, 139
factory default settings, restoring.....	134, 137
firmware version.....	143
Function keys.....	26

## G

GPIB converter.....	182
---------------------	-----

## H

humidity range.....	155
---------------------	-----

## I

I MON OUT.....	11, 120
icons.....	13
inrush current.....	155
integrated current display.....	63
integrated data.....	61
integrated power display.....	63
interface settings.....	132
IP address.....	132, 143
isolation voltage.....	145, 152, 154

## K

key lock.....	129
KEY LOCK key.....	130
keyboard.....	28

## L

LOAD key.....	30
load on/off.....	30
load value.....	13
LOCAL key.....	88
lock.....	129
logging.....	55

## M

malfunctions and causes.....	186
MEASURE key.....	12, 25
measurement.....	55
Memory.....	74
Menu keys.....	25

## N

Numeric keypad.....	28
---------------------	----

## O

OCP.....	50
OCPL.....	50
OCPT.....	50
operating area.....	166
operation mode.....	31
OPP.....	51, 175



OPPL.....	51	troubleshooting .....	186
OPPT .....	51		
overcurrent protection .....	50		
overhaul .....	144		
overpower protection.....	51, 175		
<b>P</b>			
panel operation .....	25		
panel settings at startup.....	127		
PARALLEL connector .....	123		
parallel operation.....	121		
power consumption .....	155		
power on/off .....	17		
POWER switch.....	17		
preset memory .....	75		
program.....	89, 90		
protection .....	48, 92, 125		
protection plate.....	110		
pulse function .....	42		
<b>R</b>			
remote control .....	88		
remote sensing.....	67		
Reset.....	134		
reset .....	138		
reset settings.....	139		
response speed.....	65		
Rotary knob .....	28		
<b>S</b>			
-S.....	67		
+S.....	67		
Sanitize .....	137		
SCPI error .....	135		
screen saver.....	128		
sensing cable .....	68		
sequence.....	89, 103		
SEQUENCE key .....	12, 25		
sequence tutorial.....	99		
serial number .....	15		
setup memory .....	78		
sine function .....	45		
slew rate.....	41, 165		
soft start .....	66		
SOURCE key .....	12, 25		
specifications.....	145		
step .....	89, 95		
stopper, locking.....	5		
synchronized operation .....	82		
SYSTEM key.....	12, 25		
system settings .....	126		
<b>T</b>			
temperature range.....	155		
time setting.....	136		
time zone.....	136		
TRIG OUT .....	118		
trigger .....	56, 96, 104		
trigger input/output .....	118		

If you find any misplaced or missing pages in the manuals, they will be replaced. If the manual gets lost or soiled, a new copy can be provided for a fee. In either case, please contact your Kikusui agent or distributor. At that time, inform your agent or distributor of the "Part No." written on the front cover of this manual.

Every effort has been made to ensure the accuracy of this manual. However, if you have any questions or find any errors or omissions, please contact your Kikusui agent or distributor.

After you have finished reading this manual, store it so that you can use it for reference at any time.

## **KIKUSUI ELECTRONICS CORP.**

---

1-1-3 Higashiyamata, Tsuzuki-ku, Yokohama,  
224-0023, Japan

Phone: +81-45-482-6353

Facsimile: +81-45-482-6261

**[www.kikusui.co.jp/en/](http://www.kikusui.co.jp/en/)**

