

Part No. Z1-002-592, IB003146

May. 2016

OPERATION MANUAL

Impedance Measurement Unit
PFX2000 Series

PFX2211



Use of Operation Manual

Please read through and understand this Operation Manual before operating the product. After reading, always keep the manual nearby so that you may refer to it as needed. When moving the product to another location, be sure to bring the manual as well.

If you find any incorrectly arranged or missing pages in this manual, they will be replaced. If the manual gets lost or soiled, a new copy can be provided for a fee. In either case, please contact Kikusui distributor/agent, and provide the “Kikusui Part No.” given on the cover.

This manual has been prepared with the utmost care; however, if you have any questions, or note any errors or omissions, please contact Kikusui distributor/agent.













Reproduction and reprinting of this operation manual, whole or partially, without our permission is prohibited.

Both unit specifications and manual contents are subject to change without notice.

Copyright© 2004 Kikusui Electronics Corporation

Safety Symbols

For the safe use and safe maintenance of this product, the following symbols are used throughout this manual and on the product. Understand the meanings of the symbols and observe the instructions they indicate (the choice of symbols used depends on the products).

 OR 	<p>Indicates that a high voltage (over 1000 V) is used here. Touching the part causes a possibly fatal electric shock. If physical contact is required by your work, start work only after you make sure that no voltage is output here.</p>
<p>DANGER</p>	<p>Indicates an imminently hazardous situation which, if ignored, will result in death or serious injury.</p>
 WARNING	<p>Indicates a potentially hazardous situation which, if ignored, could result in death or serious injury.</p>
 CAUTION	<p>Indicates a potentially hazardous situation which, if ignored, may result in damage to the product and other property.</p>
	<p>Shows that the act indicated is prohibited.</p>
	<p>Is placed before the sign “DANGER,” “WARNING,” or “CAUTION” to emphasize these. When this symbol is marked on the product, see the relevant sections in this manual.</p>
	<p>Indicates a protective conductor terminal.</p>
	<p>Indicates a chassis(frame) terminal.</p>
	<p>On (supply)</p>
	<p>Off (supply)</p>
	<p>In position of a bi-stable push control</p>
	<p>Out position of a bi-stable push control</p>



Safety Precautions

The following safety precautions must be observed to avoid fire hazard, electrical shock, accidents, and other failures. Keep them in mind and make sure that all of them are observed properly. Using the product in a manner that is not specified in this manual may impair the protection functions provided by the product.



Users

- This product must be used only by qualified personnel who understand the contents of this operation manual.
- If it is handled by disqualified personnel, personal injury may result. Be sure to handle it under supervision of qualified personnel (those who have electrical knowledge.)
- This product is not designed or manufactured for general home or consumer use.

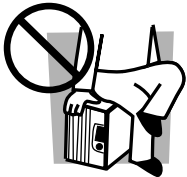

Purposes of use

- Do not use the product for purposes other than those described in the operation manual.

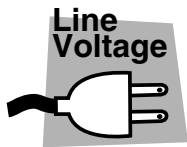

Input power

- Use the product with the specified input power voltage.
- For applying power, use the AC power cord provided. Note that the provided power cord is not use with some products that can switch among different input power voltages or use 100 V and 200 V without switching between them. In such a case, use an appropriate power cord.



Fuse

- With products with a fuse holder on the exterior surface, the fuse can be replaced with a new one. When replacing a fuse, use the one which has appropriate shape, ratings, and specifications.



Cover

- There are parts inside the product which may cause physical hazards. Do not remove the external cover.

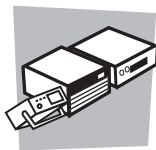

Installation

- When installing products be sure to observe “Installation” described in this manual.
- To avoid electrical shock, connect the protective ground terminal to electrical ground (safety ground).
- When connecting the AC power cord to a switchboard, be sure work is performed by a qualified and licensed electrician or is conducted under the direction of such a person.
- When installing products with casters, be sure to lock the casters.



Relocation

- Turn off the power switch and then disconnect all cables when relocating the product.
- Use two or more persons when relocating the product which weights more than 18 kg. The weight of the products can be found on the rear panel of the product and/or in this operation manual.
- Use extra precautions such as using more people when relocating into or out of present locations including inclines or steps. Also handle carefully when relocating tall products as they can fall over easily.
- Be sure the operation manual be included when the product is relocated.



Operation

- Check that the AC input voltage setting and the fuse rating are satisfied and that there is no abnormality on the surface of the AC power cord. Be sure to unplug the AC power cord or stop applying power before checking.
- If any abnormality or failure is detected in the products, stop using it immediately. Unplug the AC power cord or disconnect the AC power cord from the switchboard. Be careful not to allow the product to be used before it is completely repaired.
- For output wiring or load cables, use connection cables with larger current capacity.
- Do not disassemble or modify the product. If it must be modified, contact Kikusui distributor/agent.



Maintenance and checking

- To avoid electrical shock, be absolutely sure to unplug the AC power cord or stop applying power before performing maintenance or checking.
- Do not remove the cover when performing maintenance or checking.
- To maintain performance and safe operation of the product, it is recommended that periodic maintenance, checking, cleaning, and calibration be performed.



Service

- Internal service is to be done by Kikusui service engineers. If the product must be adjusted or repaired, contact Kikusui distributor/agent.

Contents

Safety Symbols	I
Safety Precautions	II
Preface	1
<hr/>	
Chapter 1 Setup	3
<hr/>	
1.1 Checking the Package Contents	3
1.2 Installation	4
1.2.1 Precautions Concerning Installation Location	4
1.2.2 Rack Mounting	5
1.3 Precautions When Moving the Product	5
1.4 Connecting the Power Cord	6
1.5 Connecting to the 5-Unit Frame	8
1.6 Connecting the TP-BUS	10
1.6.1 Connecting TP-BUS Cables	10
1.6.2 Setting the Termination	10
<hr/>	
Chapter 2 Turning On the Power	11
<hr/>	
Chapter 3 Names and Functions of Parts	12
<hr/>	
Chapter 4 Maintenance	14
<hr/>	
4.1 Cleaning	14
4.2 Inspection	14
4.3 Replacing the Fuse	15
4.4 Calibration	15
4.5 Malfunctions and Causes	16
<hr/>	
Chapter 5 Specifications	17
<hr/>	
5.1 Functional Specifications	17
5.2 Electrical Specifications	18
5.3 General Specifications	19
5.4 Outline Drawing	21

Preface

About This Manual

This operation manual covers information about the hardware of the PFX2211 Impedance Measurement Unit in the PFX2000 Series Charge/Discharge Battery Test System.

For information about the hardware of the entire PFX2000 system, see the *PFX2000 Series Charge/Discharge Battery Test System Operation Manual* that is included with the PFX2121 Control Unit.

This product is controlled using BPChecker2000, an application software. For details on how to use the application, see the *BPChecker2000 User's Manual*.

Product Overview

The PFX2211 Impedance Measurement Unit enables the measurement of internal impedance of batteries. It is combined with the 5-Unit Frame and Charge/Discharge Power Supply Units.

A single unit can measure up to 120 channels for each communication control unit.

Features

- Highly accurate impedance measurement is possible using the AC four-wire system (complies with Japanese Industrial Standard: JIS C8705 and C8708 1-kHz Alternating Current Method).
- Adoption of a constant current system enables measurements free from the effects of the output cable resistance and bad contacts of fixtures.
- Designed specifically for measuring the internal impedance of the secondary batteries such as Nickel-Metal Hydride (Ni-MH), Nickel-Cadmium (Ni-cd), and lithium ion, the operation is easier than general LCR meters.
- Measures R , jX , and $|Z|$ in the range of $10 \mu\Omega$ to 10Ω and phase difference θ between $+90^\circ$ to -90° at a minimum resolution of $10 \mu\Omega/0.1^\circ$ at a frequency of 1 kHz.

Optional accessories

Cables

To connect the impedance measurement unit to the 5-Unit Frame, you will need modular cables and UTP cables for the number of frames to be used.

These cables are sold as optional accessories so that you can purchase the required number of cables. The cable set includes one modular cable and one UTP cable, and you can purchase any number of sets. If you require cables, contact your Kikusui agent or distributor.

TableP-1 Cable Set (Sold Separately)

Code	Model	Contents
84270	TL02-PFX(1M)	Modular cable: 1 pc. (1 m) UTP cable: 1 pc. (1 m)
84280	TL02-PFX(3M)	Modular cable: 1 pc. (3 m) UTP cable: 1 pc. (3 m)
84290	TL02-PFX(5M)	Modular cable: 1 pc. (5 m) UTP cable: 1 pc. (5 m)

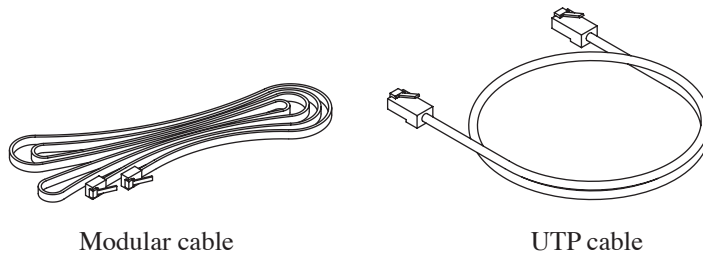

Modular cable
Fig.P-1 Cables

UTP cable

This chapter describes the steps taken before actually using the product such as unpacking, installation, etc.

1.1 Checking the Package Contents

When you receive the product, check that all accessories are included and that the accessories have not been damaged during transportation.

If any of the accessories are damaged or missing, contact your Kikusui agent or distributor.

NOTE

- It is recommend that all packing materials be saved, in case the product needs to be transported at a later date.
-

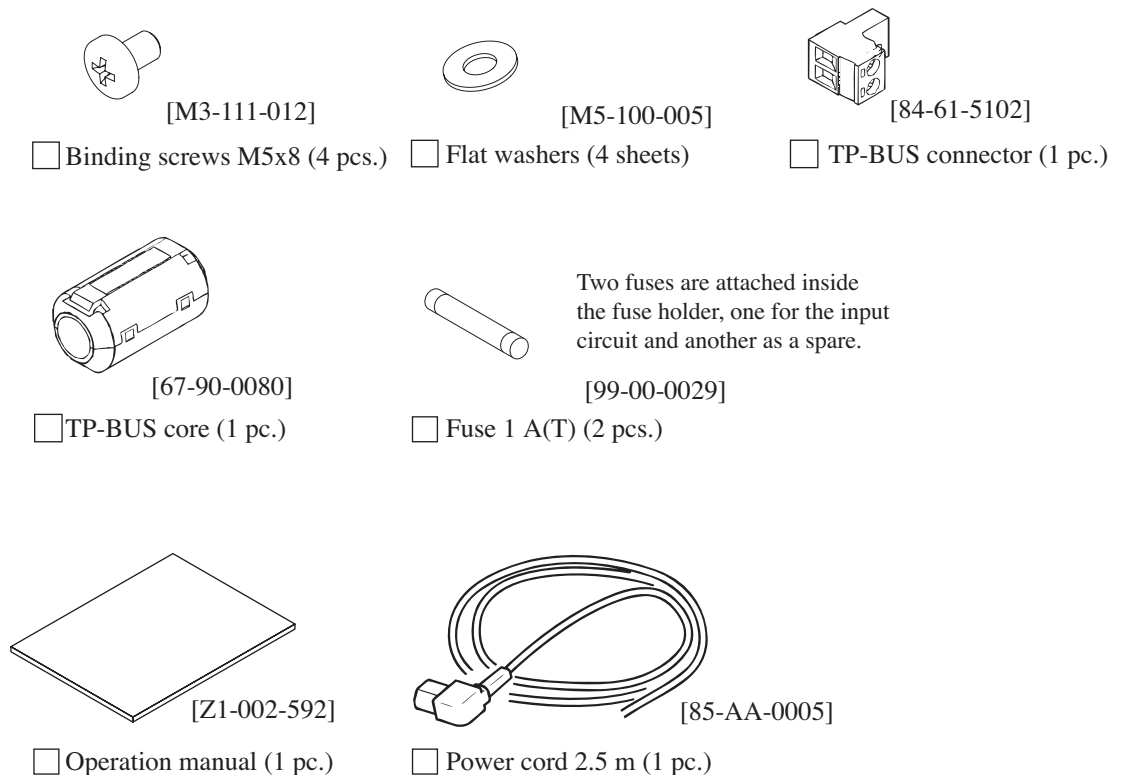

Fig.1-1 Accessories

1.2 Installation

This section describes the precautions concerning the installation location of the product and the rack mounting of the product.

1.2.1 Precautions Concerning Installation Location

This section describes the precautions to be taken when installing the product. Make sure to observe them.

■ **Do not use the product in a flammable atmosphere.**

To prevent the possibility of explosion or fire, do not use the product near alcohol or thinner or in an atmosphere containing such vapors.

■ **Avoid locations where the product is exposed to high temperature or direct sunlight.**

Do not place the product near a heater or in areas subject to drastic temperature changes.

Operation temperature range: 0 °C to +40 °C (+32 °F to +104 °F)

Storage temperature range: -10 °C to +60 °C (+14 °F to +140 °F)

■ **Avoid locations of high humidity.**

Do not place the product in high-humidity locations, i.e., near a boiler, humidifier, water supply, etc.

Operation humidity range: 30 % to 80 % [RH] (no condensation)

Storage humidity range: 20 % to 80 % [RH] (no condensation)

Condensation may occur even in the operation humidity range. In such case, do not use the product until the condensation dries up completely.

■ **Do not place the product in a corrosive atmosphere.**

Do not install the product in a corrosive atmosphere or in environments containing sulfuric acid mist, etc. This may cause corrosion of various conductors and bad contacts of connectors inside the product leading to malfunction and failure, or in the worst case, a fire.

■ **Do not place the product in a dusty location.**

Accumulation of dust can lead to electric shock or fire.

■ **Do not use the product where ventilation is poor.**

Secure adequate space around the product so that air can circulate around it.

■ **Do not place objects on top of the product.**

Placing objects on top of the product can cause failures (especially heavy objects).

■ **Do not place the product on an inclined surface or location subject to vibrations.**

The product may fall or tip over causing damages and injuries.

- **Do not use the product in a location subject to strong magnetic or electric fields.**

The product may malfunction and cause electric shock or fire.

- **Do not use the product near highly sensitive measuring instruments or transceivers.**

The noise generated by the product may affect them.

- **Use the product in an industrial environment.**

The product may cause interference if used in residential areas. Such use must be avoided unless the user takes special measures to reduce electromagnetic emissions to prevent interference to the reception of radio and television broadcasts.

1.2.2 Rack Mounting

The Impedance Measurement Unit is designed on the assumption that it be rack mounted in an EIA standard rack with the 5-Unit Frames.

For more details on rack mounting, see section 1.2.2, “Rack Mounting” in the *PFX2000 Series Charge/Discharge Battery Test System Operation Manual* that comes with the Communication Control Unit.

1.3 Precautions When Moving the Product

When moving the product to the installation location or when transporting the unit, note the following points.

- **Turn off the POWER switch.**

Moving the unit while the power is turned on can cause electric shock or damage to the unit.

- **Remove wiring.**

Moving the product with the cables connected can cause wires to break or injuries if the product is dropped.

- **When transporting the product, be sure to use the original packing materials.**

Otherwise, damage may result from vibrations or from the product falling during transportation.

1.4 Connecting the Power Cord

The PFX2211 is designed as an equipment of IEC Overvoltage Category II (energy-consuming equipment supplied from the fixed installation).

⚠ WARNING Possible electric shock.

- The product is an IEC Safety Class I equipment (equipment with a protective conductor terminal). Be sure to ground (earth) the unit.
- Connect the protective conductor terminal to earth ground.
- If you are connecting the power cord to a switchboard, turn off the circuit breaker of switchboard before connecting the power cord.

Possible fire.

- Have a qualified engineer connect the power cord to the switchboard.
- If you are connecting the power cord to a switchboard, the breaker of switchboard is required to meet following requirement.

⚠ CAUTION • Inside the product, protective circuits including input fuses are connected to match the polarity of the input terminal. Make sure the colors of the wires connected to the corresponding input terminals (L, N, and ⊕ (GND)) are correct.

NOTE • Turn off the circuit breaker of switchboard to disconnect the product from the AC line in an emergency. If you are connecting the power cord with the plug to an AC line, unplug.

■ Circuit breaker of switchboard requirement

- Rated current: 30 A including one unit frame (The circuit breaker of which the rated current is more than 30 A is disabled for safety.)
- Dedicate the circuit breaker for the PFX2000 system.
- Keep the switchboard easily accessible at any time.
- Require labeling to identify that the circuit breaker is dedicated for the PFX2000 system and disconnecting device.

1. Check that the AC power line meets the nominal input specifications of the PFX2211.

Nominal input rating: 200 VAC to 240 VAC, 50/60 Hz, single phase

Power consumption: 25 VA max

2. Turn off the power switch.
3. Prepare the terminals at the AC power line end of the power cord as shown in Fig. 1-2.

The AC power line end of the power cord that comes with the PFX2211 comes in a cut condition. Remove the insulation so that a plug or crimp terminal can be attached to the wires.

4. Attach a plug or crimp terminals to the power cord.
5. Connect the power cord to the AC LINE connector on the rear panel.
6. If you are connecting the power cord to a switchboard, turn off the circuit breaker of switchboard.
7. Connect the power cord to a power outlet or a switchboard.

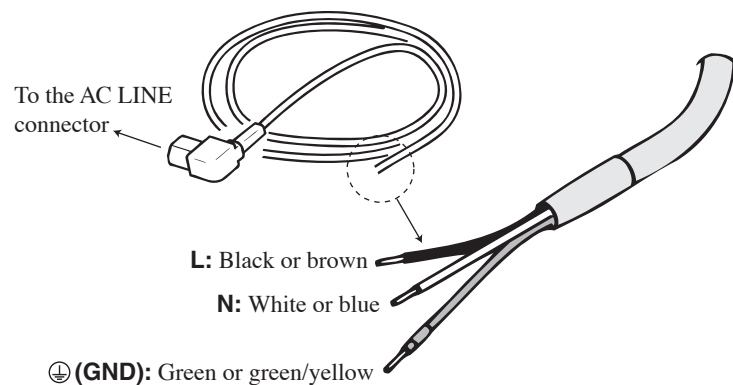

Fig. 1-2 Power Cord

1.5 Connecting to the 5-Unit Frame

The Impedance Measurement Unit has 12 ports for connecting to the 5-Unit Frames (up to 12 5-Unit Frames to be connected).

Each port consists of a DUT terminal (8 pins) and a CONT terminal (6 pins). The number assigned to each port (FRAME 1 to 12) corresponds to the frame address number of the frame to be connected. For example, the DUT and CONT terminals of port 1 (FRAME 1) are connected to the DUT and CONT terminals of the 5-Unit Frame with frame address 1. DUT terminals are connected using an UTP cable; CONT terminals are connected using a modular cable. See Fig. 1-4 and Table 1-2.

NOTE

- The modular and UTP cables are sold separately. The cable set contains one of each cable, and you can purchase any number of cable sets. If you require cables, contact your Kikusui agent or distributor.

Table1-1 Cable Set (Sold Separately)

Code	Model	Contents
84270	TL02-PFX(1M)	Modular cable: 1 pc. (1 m) UTP cable: 1 pc. (1 m)
84280	TL02-PFX(3M)	Modular cable: 1 pc. (3 m) UTP cable: 1 pc. (3 m)
84290	TL02-PFX(5M)	Modular cable: 1 pc. (5 m) UTP cable: 1 pc. (5 m)

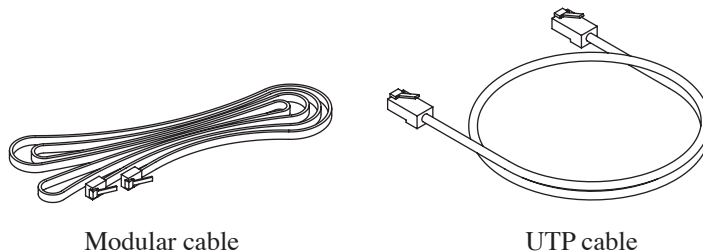

Modular cable
Fig. 1-3 Cables

UTP cable

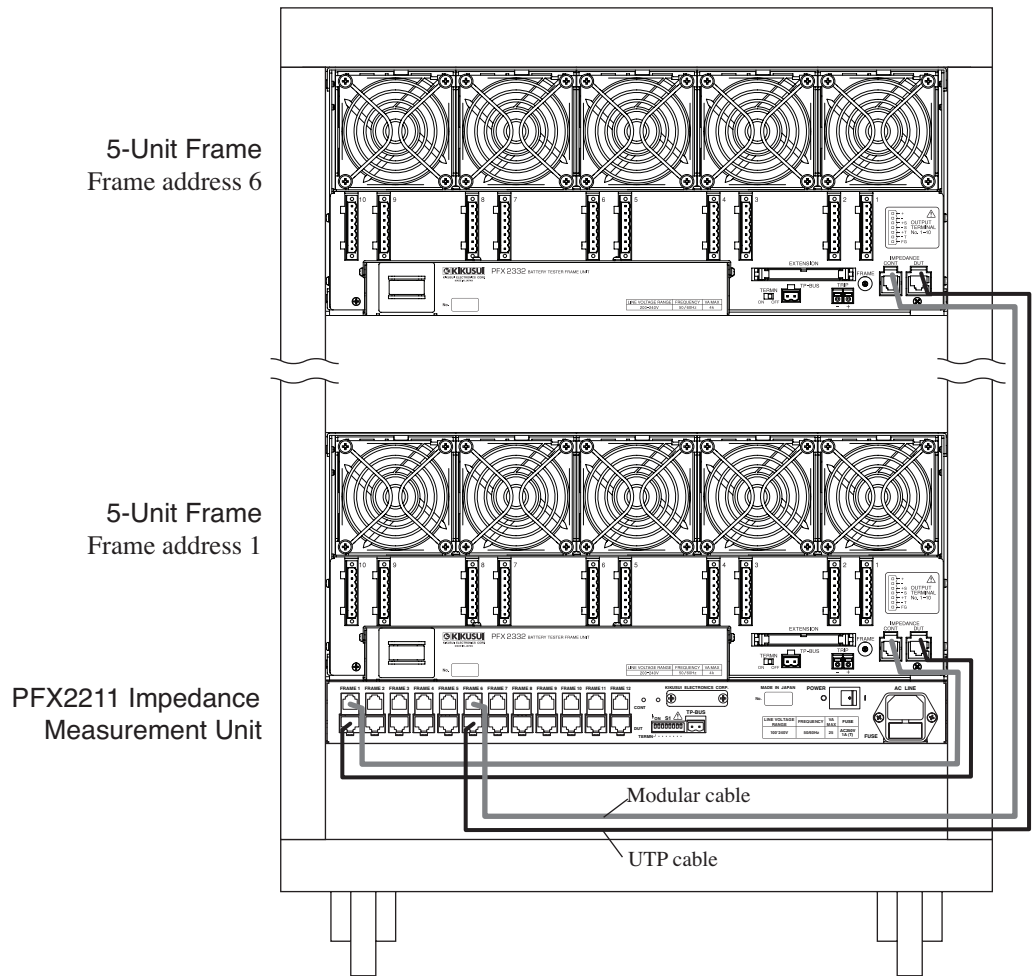

Fig. 1-4 Connection with Frames

Table 1-2 Connection Table

PFX2211	↔	5-Unit Frame	PFX2211	↔	5-Unit Frame
FRAME 1	CONT	Frame address 1	FRAME 7	CONT	Frame address 7
	DUT			DUT	
FRAME 2	CONT	Frame address 2	FRAME 8	CONT	Frame address 8
	DUT			DUT	
FRAME 3	CONT	Frame address 3	FRAME 9	CONT	Frame address 9
	DUT			DUT	
FRAME 4	CONT	Frame address 4	FRAME 10	CONT	Frame address A
	DUT			DUT	
FRAME 5	CONT	Frame address 5	FRAME 11	CONT	Frame address B
	DUT			DUT	
FRAME 6	CONT	Frame address 6	FRAME 12	CONT	Frame address C
	DUT			DUT	

1.6 Connecting the TP-BUS

1.6.1 Connecting TP-BUS Cables

The Communication Control Unit, 5-Unit Frames, and Impedance Measurement Unit are connected using the TP-BUS. The TP-BUS is connected in a chain by connecting twisted-pair cables to the TP-BUS connectors (plug) provided.

For the procedure in connecting the TP-BUS, see section 1.7, “Connecting the TP-BUS” in the *PFX2000 Series Charge/Discharge Battery Test System Operation Manual* that comes with the Control Unit.

NOTE

- Be sure to connect the Impedance Measurement Unit to TP-BUS 1.
- On the 5-Unit Frame, you must set a frame address on each frame as an address on the TP-BUS. However, this product does not require the setting of an address on the TP-BUS.

Like the charge/discharge power supply units, the address of the product is managed using a node number, and the number is fixed inside the product. Therefore, you cannot connect multiple impedance measurement units to a single control unit.

1.6.2 Setting the Termination

CAUTION

- If the termination is not set properly, communications become unstable and erroneous operation may result.

Turn on the termination on the device at the end of the TP-BUS located opposite to the Control Unit.

Taking the TP-BUS connection diagram in section 1.7.1, “Connecting TP-BUS Cables” in the *PFX2000 Series Charge/Discharge Battery Test System Operation Manual* as an example, the termination on the 5-Unit Frame at the end of the TP-BUS is turned on, and the termination on all other units are turned off. Therefore, turn off the termination also on the impedance measurement unit.

If you are connecting the impedance measurement unit to the end of the TP-BUS, turn on the S1 switch as shown in Fig. 1-5.

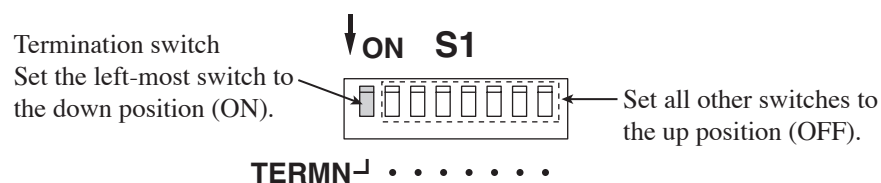

Fig. 1-5 Termination ON Setting

This chapter describes the procedures for turning on the power.

This product is controlled using BPChecker2000, an application software. For details on how to use the application, see the *BPChecker2000 User's Manual*.

There is no particular order for turning on the PFX2000 Series Battery Test System. You can first turn on the Communication Control Unit, any of the 5-Unit Frames, or the Impedance Measurement Unit.

1. Check that the power cord is correctly connected.
2. Turn on the POWER switch on the rear panel.

The POWER/ALARM LED and the MEASUREMENT LED blink alternately green and red for a few seconds, and then the POWER/ALARM LED illuminates in green.

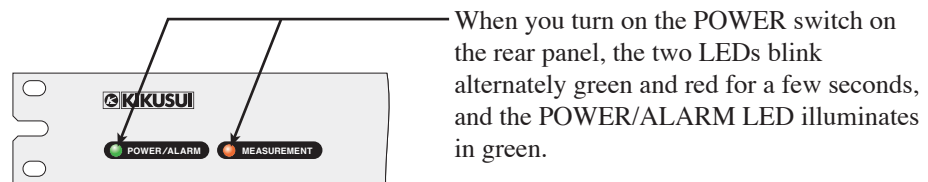

When you turn on the POWER switch on the rear panel, the two LEDs blink alternately green and red for a few seconds, and the POWER/ALARM LED illuminates in green.

Fig. 2-1 Status after Power On

This chapter describes the names and functions of switches, displays, connectors, and other parts of the panels.

Read this chapter to learn about the details of the ⚠ (alert) marks indicated on the panel.

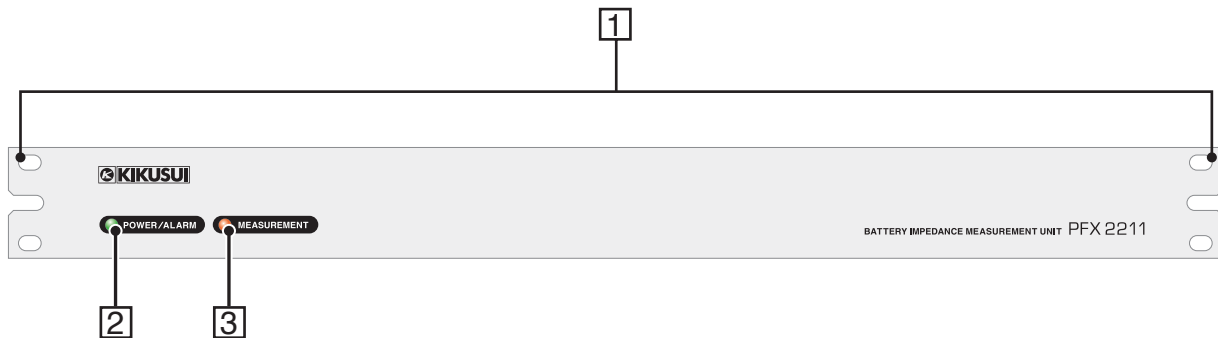

Fig.3-1 PFX2211 Front Panel

[1] Bracket

Bracket for racking the unit on an EIA standard rack.

For details on rack mounting, see section 1.2.2, “Rack Mounting.”

[2] POWER/ALARM

The operation status of this product is indicated using LED colors.

- Illuminated in green: Indicates the power is being supplied to the product.
- Illuminated in red: Indicates the alarm status.

[3] MEASUREMENT

The operation status of this product is indicated using LED colors.

- Illuminated in red: Indicates that impedance is being measured.

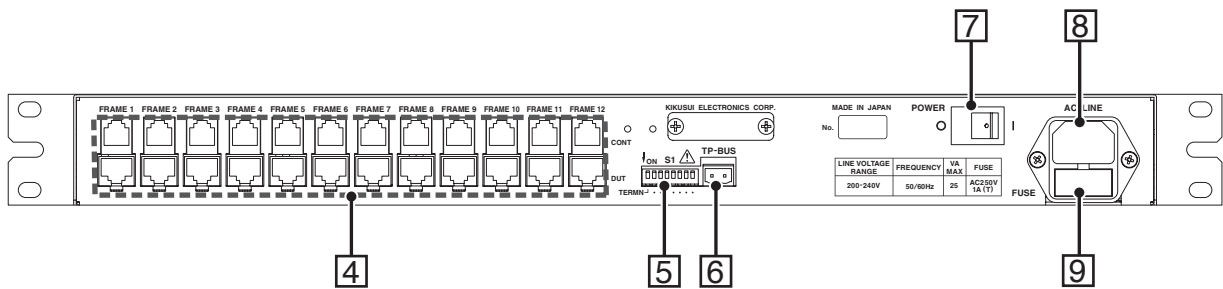

Fig. 3-2 PFX2211 Rear panel

[4] FRAME 1 to 12 (port)

Connector for connecting to the 5-Unit Frame. Each port consists of a DUT terminal (8 pins) and a CONT terminal (6 pins).

For details on the connection, see section 1.5, “Connecting to the 5-Unit Frame.”

[5] S1 ⚠

Of the eight switches that are aligned, the left-most switch when facing the rear panel is the switch used to turn on/off the TP-BUS termination (TERMN). Turn off all other switches.

For a description of the TERMN setting, see section 1.6.2, “Setting the Termination.”

[6] TP-BUS

Connector for connecting the TP-BUS cable.

For details on the connection, see section 1.6, “Connecting the TP-BUS.”

[7] POWER

Power switch of the product. “|” side is on; “O” side is off.

[8] AC LINE

Power cord connector for supplying power to the product. Insert the power cord that came with the package.

⚠ WARNING • Improper handling can lead electric shock. When connecting the power cord, be sure to read section 1.4, “Connecting the Power Cord.”

[9] FUSE

Contains an input fuse and a spare fuse.

⚠ WARNING • Improper handling can lead electric shock. When replacing the fuse, be sure to read section 4.3, “Replacing the Fuse.”

This chapter describes maintenance and calibration of the product. It also describes troubleshooting measures when you suspect that malfunction has occurred while using the product.

-
- ⚠ WARNING** • Some parts inside the product may cause physical hazards. Do not remove the external cover.
-

4.1 Cleaning

Cleaning the panels

If the panel needs cleaning, gently wipe using a soft cloth with water-diluted neutral detergent.

-
- ⚠ WARNING** • Be sure to turn off the POWER switch on the device and the switchboard switch.
- ⚠ CAUTION** • Do not use volatile solvents such as thinner or benzene. They may discolor the surface or erase the printed characters.
-

4.2 Inspection

Power cord

Check that the insulation coating is not broken, that the crimp terminal is not loose, and that the wire is not broken.

-
- ⚠ WARNING** • Be sure to turn off the POWER switch on the device and the switchboard switch.
- Breaks in the insulation coating may cause electric shock. If a break is found, stop using it immediately.
-

To purchase accessories, contact your Kikusui agent or distributor.

4.3 Replacing the Fuse

You can replace the input fuse of this product. If the fuse blows due to deterioration, you must replace the fuse.



WARNING

- To prevent the possibility of electric shock, be sure to turn OFF the POWER switch and the switchboard switch before replacing the fuse.
- Use a fuse of shape, rating, and characteristics that conform to the product (1 A (T), 250 VAC). Using a fuse of a different rating or shorting the fuse holder is dangerous. Never carry out such acts.

1. Turn off the POWER switch and the switchboard switch.
2. Remove the power cord from the AC LINE connector on the rear panel.
3. Remove the fuse holder using a tool such as a flat-blade screwdriver as shown in Fig. 4-1.

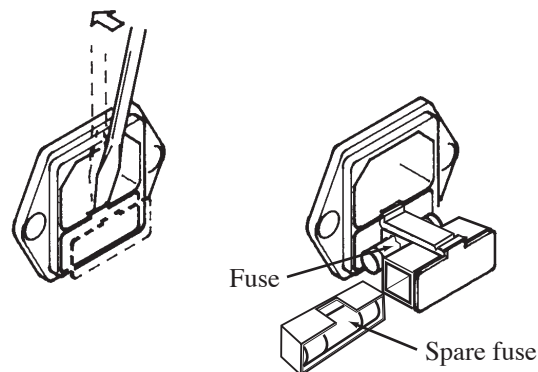

Fig.4-1 Method of Removing the Fuse Holder

4.4 Calibration

The product is calibrated at the factory before shipment. However, periodic calibration is necessary due to changes that occur after extended use.

For calibration, contact your Kikusui agent or distributor.

4.5 Malfunctions and Causes

This section describes remedies for malfunctions encountered during the use of the product.

Typical symptoms and check items are indicated. In some cases, the problem can be solved quite easily.

If you find an item that corresponds to your case, follow the remedy for the item. If the remedy does not solve the problem or if your case does not match any of the items, contact your Kikusui agent or distributor.

■ Symptom 1: The LED indication is abnormal.

Check Item	Cause and Remedy
<ul style="list-style-type: none"> ■ After turning on the power, the two LEDs on the panel remain blinking. Or, the POWER/ALARM LED is illuminated in red. 	<ul style="list-style-type: none"> • A malfunction has occurred inside the device. Power-cycle the system. If the LED keeps blinking even after power-cycling the product, contact your Kikusui agent or distributor.

■ Symptom 2: The measured value is way off.

Check Item	Cause and Remedy
<ul style="list-style-type: none"> ■ The UTP cable connected to the DUT terminal is broken. 	<ul style="list-style-type: none"> • Replace the UTP cable with a new one.
<ul style="list-style-type: none"> ■ The DUT and CONT terminals of a frame different from the one that is actually measured are connected. 	<ul style="list-style-type: none"> • See section 1.5, “Connecting to the 5-Unit Frame” and properly connect the cables.
<ul style="list-style-type: none"> ■ The UTP and module cable pair is unmatched. 	<ul style="list-style-type: none"> • See section 1.5, “Connecting to the 5-Unit Frame” and properly connect the cables.
<ul style="list-style-type: none"> ■ The current line or sensing line is not connected. 	<ul style="list-style-type: none"> • See section 2.2, “Connecting the Output Cables” in the <i>PFX2000 Series Charge/Discharge Battery Test System Operation Manual</i> and connect the cables correctly.

This chapter describes the electrical and mechanical specifications of this product.

5.1 Functional Specifications

Item		PFX2211 Specifications
Function		
Number of connectable frames		12 frames
Number of controllable external scanner channels		10 channels (per frame)
Maximum number of measurement channels		120 channels (when combined with the PFX2332)
Measurement		
Measurable battery voltage range		-2.0 V to 20.0 V
Measurement time		3 s (per channel)
Measurement parameter	Resistance	R [Ω]
	Reactance	$\pm jX$ [Ω]
	Impedance	$ Z $ [Ω]
	Phase angle	θ [deg]

5.2 Electrical Specifications

Item		PFX2211 Specifications	
Measurement range and accuracy			
R, $\pm jX$, $ Z $ (*1)	100 m Ω Range	Measurement range	0.01 m Ω to 101.00 m Ω
		Accuracy (*2)	\pm (0.8 % of reading + 0.8 % FS)
		Resolution	0.01 m Ω
		Measurement current	18 mA [rms]
		Measurement current accuracy (*2)	\pm 10 %
	1 Ω Range	Measurement range	0.0001 Ω to 1.0100 Ω
		Accuracy (*2)	\pm (0.8 % of reading + 0.8 % FS)
		Resolution	0.1 m Ω
		Measurement current	1.8 mA [rms]
		Measurement current accuracy (*2)	\pm 10 %
	10 Ω Range	Measurement range	0.001 Ω to 10.100 Ω
		Accuracy (*2)	\pm (0.8 % of reading + 0.8 % FS)
		Resolution	1 m Ω
		Measurement current	0.18 mA [rms]
		Measurement current accuracy (*2)	\pm 10 %
θ (*3)	Measurement range	-90.0 deg to 90.0 deg	
	Resolution	0.1 deg	
Output signal			
Measurement signal	Frequency	1.0 kHz	
	Accuracy (*2)	\pm 0.1 %	
Indication			
POWER/ ALARM	Green/red	Blinking: Only during power-on. Blinks alternately.	
	Green	Illuminated: When power is supplied.	
	Red	Illuminated: When alarm occurs.	
MEASURE	Green/red	Blinking: Only during power-on. Blinks alternately.	
	Red	Illuminated: Impedance being measured.	

*1 The value of $|Z|$ is indicated as a value that is derived by the application based on R and jX .

*2 Ambient temperature: 18 °C to 28 °C (64.4 °F to 82.4 °F)

*3 The value of θ is indicated as a value that is derived by the application based on R and jX .

5.3 General Specifications

Item		PFX2211 Specifications
Temperature range	Operating temperature range	0 °C to 40 °C (+32 °F to +104 °F)
	Storage temperature range	-10 °C to 60 °C (+14 °F to +140 °F)
Humidity range	Operating humidity range	30 % to 80 % RH (no condensation)
	Storage humidity range	20 % to 80 % RH (no condensation)
Insulation resistance	Between AC input and chassis	100 MΩ or more at 500 VDC
	Between input/output connector and chassis	20 MΩ or more at 50 VDC
Withstand voltage	Between AC input and chassis	1 500 VAC, 10 mA or less for 1 minute
AC input	Nominal input rating	200 V to 240 VAC, 50/60 Hz, single phase
	Input voltage range	180 V to 250 VAC
	Power consumption	25 VA max
TP-BUS interface	Address	Fixed
Dimensions		See outline drawing
Weight		Approx. 4 kg (8.82 lb)
Accessories	Binding screws: 4 pcs	
	Flat washers: 4 sheets	
	TP-BUS connector: 1 pc	
	TP-BUS core: 1 pc	
	Fuse: 2 pcs. (1 A (T), 250 VAC)	
	Operation manual: 1 pc	
		Power cord: 1 pc

Input/output connector

Item		PFX2211 Specifications	
TP-BUS connector			
Number of lines		1 line	
Connection		Connect with the Communication Control Unit Using the TP-BUS connector included in the package.	
		Total length	200 m or less
		Number of twists	1 turn/cm or more
Polarity		None	
Applicable wire size	Solid line		ϕ 0.65 (AWG22)
	Stranded wire		0.32 mm ²
DUT connector (FRAME 1 to FRAME 12)			
Number of lines		12 lines	
Connection		Connect with the 5-Unit Frame	
Applicable cable		UTP cable	
Pin assignments	1	FG	Chassis ground (for sensing wire shield)
	2	FG	Chassis ground (for sensing wire shield)
	3	AC SRC P	Current terminal for measurement (+)
	4	AC SENSE P	Impedance detection terminal (+)
	5	AC SENSE N	Impedance detection terminal (-)
	6	AC SRC N	Current terminal for measurement (-)
	7	+5VR	Power to the PFX2332 scanner
	8	GND	Power to the PFX2332 scanner
CONT connector (FRAME 1 to FRAME 12)			
Number of lines		12 lines	
Connection		Connect with the 5-Unit Frame	
Applicable cable		4-pin modular cable	
Pin assignments	1	NC	Not used
	2	CHSEL 0	Frame scanner control logic (bit 0)
	3	CHSEL 1	Frame scanner control logic (bit 1)
	4	CHSEL 2	Frame scanner control logic (bit 2)
	5	CHSEL 3	Frame scanner control logic (bit 3)
	6	NC	Not used

5.4 Outline Drawing

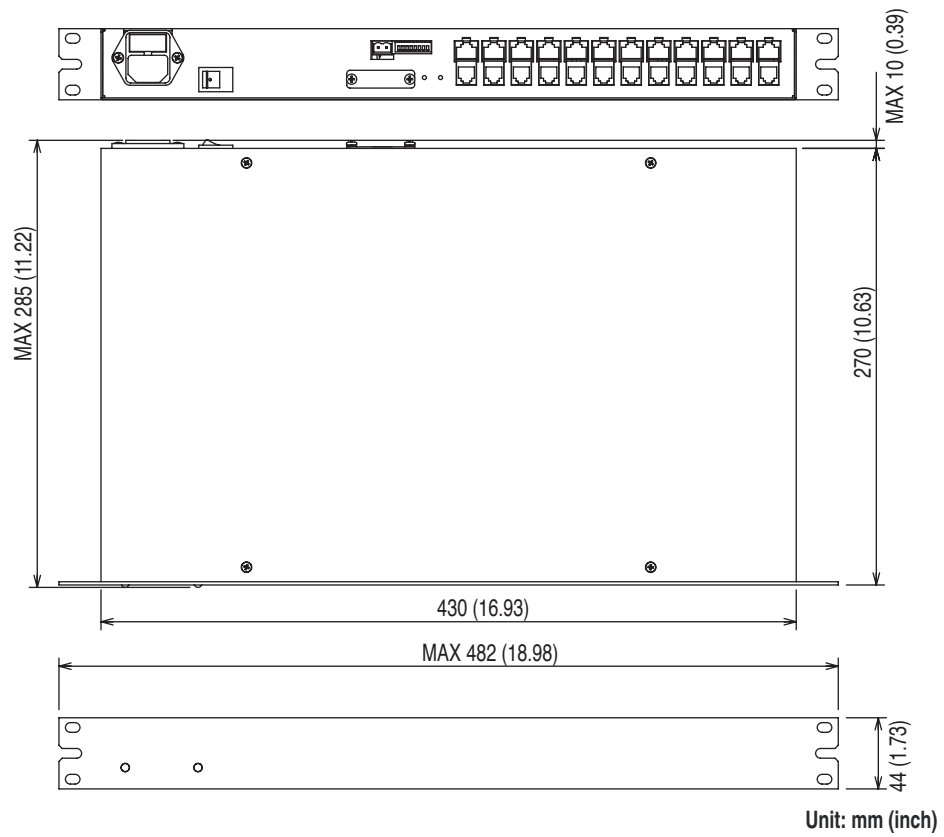

Fig. 5-1 PFX2211 Impedance Measurement Unit

KIKUSUI ELECTRONICS CORP.

1-1-3 Higashiyamata, Tsuzuki-ku, Yokohama,
224-0023, Japan
Tel: +81-45-593-7570 Fax: +81-45-593-7571



Website

<http://www.kikusui.co.jp/en>