

User's Manual

PCR-WE Series AC Power Supply

PCR1000WE

PCR2000WE

PCR-WE2 Series AC Power Supply

PCR3000WE2

PCR6000WE2/ PCR6000WE2R

PCR12000WE2/ PCR12000WE2R

PCR18000WE2/ PCR18000WE2R

PCR24000WE2/ PCR24000WE2R

PCR30000WE2/ PCR30000WE2R

PCR36000WE2/ PCR36000WE2R

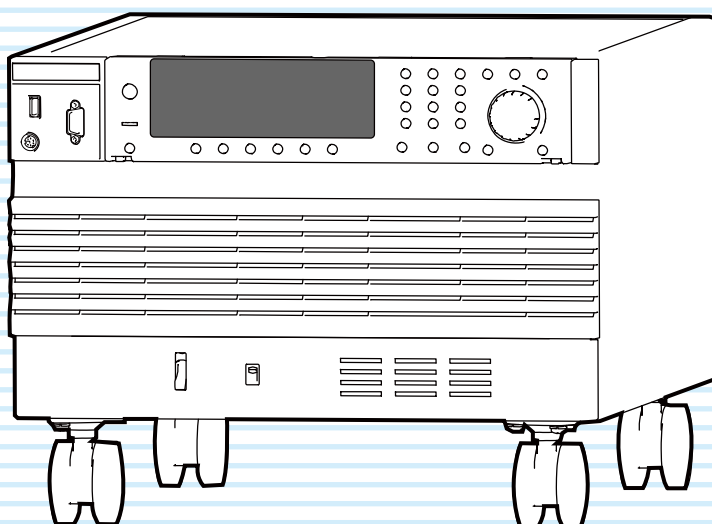

Contents 7

Component Names 10

Installation 16

Basic Functions 37

Advanced Functions 84

Sequence Function 112

External Control 151

Parallel Operation 177

System Settings 187

Maintenance 197

Specifications 200

Appendix 222









About Manuals

This manual provides an overview of the product and notes on usage. It also explains how to configure it, operate it, perform maintenance on it, and so on. Read this manual thoroughly before use, and use the product properly.

Intended readers

These manuals are intended for users of this product and their instructors. The manuals assume that the reader has knowledge about power supplies.

Manual construction

- User's manual  (this manual)
This document is intended for first-time users of this product. It provides an overview of the product, notes on usage, and specifications. It also explains how to connect the product, configure the product, operate the product, perform maintenance on the product, and so on.
- Communication Interface Manual 
This document contains details about remote control. The interface manual is written for readers with sufficient basic knowledge of how to control measuring instruments using a PC.
- Read This First!  
This document is intended for first-time users of the product. It gives an overview of the product, safety precautions, and so on.
- Quick Reference  
This document briefly explains how to use the soft keys.
- Safety Information  
This document contains general safety precautions. Keep them in mind and make sure to observe them.

PDF files are included in the accompanying CD-ROM. You can view the PDF files using Adobe Reader.

Firmware versions that this manual covers

This manual covers firmware versions 1.4X.

When contacting us about the product, please provide us with:

- The model
- The firmware version
- The serial number

For information on how to check the model firmware version, and serial number, see "Viewing the firmware version" (p.46).

Trademarks

Microsoft is a registered trademark or trademark of Microsoft Corporation in the United States and/or other countries.

Other company names and product names used in this manual are generally trademarks or registered trademarks of the respective companies.

Copyright

Reproduction and reprinting of this operation manual, whole or partially, without our permission is prohibited.

Both unit specifications and manual contents are subject to change without notice.

© Copyright 2018 Kikusui Electronics Corporation

Open Source Software

This product contains open source software under the licensing terms of GNU General Public License (GPL), GNU LESSER General Public License (LGPL), and other licenses. For details, see the following URL.

<https://rddocuments.kikusui.co.jp/oss/pcrwe>

Notations Used in This Document

- In this manual, the PCR-WE Series AC Power Supply is also referred to as the “PCR-WE.” The PCR-WE2 Series AC Power Supply is also referred to as the “PCR-WE2.” PCR-WE Series/PCR-WE2 Series is also referred to as the “PCR-WE/PCR-WE2.”
The PCR6000WE2R, PCR12000WE2R, PCR18000WE2R, PCR24000WE2R, PCR30000WE2R, and PCR36000WE2R are also referred to as the “PCR-WE2R.”
Single-phase output, single-phase three-wire output, and three-phase output are also referred to as 1P, 1P3W, and 3W, respectively.
- The term “PC” is used to refer generally to both personal computers and workstations.
- The screen captures and illustrations used in this text may differ from the actual items.
- The PCR-WE2R has a regeneration function. Because the operation and panel diagrams are the same as those of the PCR6000WE2/PCR12000WE2/PCR18000WE2/PCR24000WE2/PCR30000WE2/PCR36000WE2, read the model names in the text as follows:
PCR6000WE2R:PCR6000WE2 → PCR6000WE2R
PCR12000WE2R:PCR12000WE2 → PCR12000WE2R
PCR18000WE2R:PCR18000WE2 → PCR18000WE2R
PCR24000WE2R:PCR24000WE2 → PCR24000WE2R
PCR30000WE2R:PCR30000WE2 → PCR30000WE2R
PCR36000WE2R:PCR36000WE2 → PCR36000WE2R
- The following markings are used in this manual.

WARNING

Indicates a potentially hazardous situation which, if ignored, could result in death or serious injury.

CAUTION

Indicates a potentially hazardous situation which, if ignored, may result in damage to the product or other property.

NOTE

Indicates information that you should know.



Indicates a reference manual (CD-ROM) containing detailed information.



This indicates the hierarchy of the items that you select with the panel keys and function keys. The item to the left of this symbol indicates a higher level item.

For example, press V > ACVOLT (F1) indicates that you need to press the V key and then the ACVOLT (F1) function key.

(SHIFT+key name)

Indicates an operation that requires you to press a key indicated in blue characters (the lower row of text to the left of the key) while holding down SHIFT.

Checking the Package Contents

Check that all accessories are included and that the main unit and accessories have not been damaged during transportation.

If the main unit or any of the accessories are damaged or missing, contact your Kikusui agent or distributor.

We recommend that you save all packing materials, in case the product needs to be transported at a later date.

Accessories

- Cable tie (4 pc.) [P4-200-006]
- External control (DIGITAL I/O) connector (1 pc.)
PCR6000WE2/ PCR12000WE2/ PCR18000WE2/
PCR24000WE2/ PCR30000WE2/ PCR36000WE2
have connectors stored on the back of the control panel.

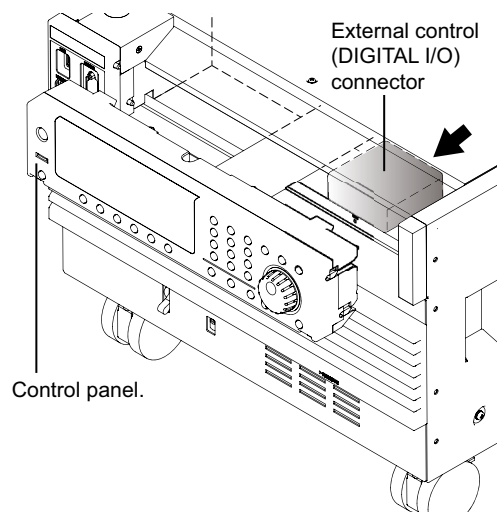

- Heavy object warning label (1 pc.) (excluding the PCR1000WE)
- Read This First! (1 copy)
- Quick Reference (1 sheet)
- CD-ROM (1 disc)
- Safety Information (1 copy)

Safety Precautions

When installing this product, be sure to observe the precautions provided in the Safety information manual.

Precautions When Choosing the Installation Location

When installing this product, be sure to observe the “Precautions When Choosing the Installation Location” in the Safety information manual. Items specific to this product are given below.

- The PCR-WE2R is designed for local regeneration applications. It cannot be used if the local power consumption is less than the regenerated power.
- When installing this product, be sure to observe the temperature and humidity ranges indicated below.
Operating temperature range: 0 °C to 50 °C (32°F to 122°F)
Operating humidity range: 20 %rh to 80 %rh (no condensation)
- When storing this product, be sure to observe the temperature and humidity ranges indicated below.
Storage temperature range: -10 °C to 60 °C (14 °F to 140 °F)
Storage humidity range: 90 %rh or less (no condensation)
- Allow at least 50 cm of space between the air inlet/outlet and the wall (or obstacles).
- Fix the product to the floor using L-shaped or other similar brackets (PCR3000WE2, PCR3600WE2 only).
Base hold angles (OP03-KRC) are available as options.

Moving the Product

When moving or transporting this product to the installation location, be sure to observe the “Precautions When Choosing the Installation Location” in the Safety information manual. Items specific to this product are given below.

- Raise the stopper (PCR1800WE2, PCR2400WE2, PCR3000WE2, PCR3600WE2 only).
Moving the product without raising the stopper may cause injuries due to the product falling over.
- Unlock the casters (PCR1000WE, PCR2000WE, PCR3000WE2 excluded).
- Do not move the product by yourself (PCR3000WE2, PCR3600WE2 only).
Be sure to have two or more people move the product. Exercise special care when carrying the product over a slope or across steps.
If you are using a forklift, be sure to slide the forks under the bottom of the product, check that the product is stable, and then raise the product.
If you are using a band or similar item to raise the product with a crane, be sure to slide the band under the bottom of the product, check that the product is stable, and then raise the product.
- Do not tip the product on its side or turn it upside down.

Locking the casters and using the stopper (PCR1000WE, PCR2000WE, PCR3000WE2 excluded).

This product has casters on its bottom side, so it is easy to move the product. To ensure that the product is not moved accidentally while it is being operated, lock the casters with your foot. For the PCR1800WE2, PCR2400WE2, PCR3000WE2, and PCR3600WE2, use stoppers to fix the product in the installation location.

Looking down at the stopper from above, turning the stopper to the left (counterclockwise) raises the stopper, and turning the stopper to the right (clockwise) lowers the stopper.

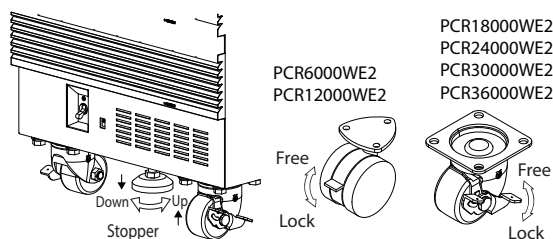

Product Overview

PCR-WE/PCR-WE2 lineup

Model	Rated output capacity		Maximum output current			
	1P output 3P output	1P3W output	1P output		1P3W output 3P output	
			100 V output	200 V output	100 V output	200 V output
PCR 1000WE	1 kVA	—	10 A	5 A	—	—
PCR 2000WE	2 kVA	—	20 A	10 A	—	—
PCR 3000WE2	3 kVA	2 kVA	30 A	15 A	10 A	5 A
PCR 6000WE2	6 kVA	4 kVA	60 A	30 A	20 A	10 A
PCR 12000WE2	12 kVA	8 kVA	120 A	60 A	40 A	20 A
PCR 18000WE2	18 kVA	12 kVA	180 A	90 A	60 A	30 A
PCR 24000WE2	24 kVA	16 kVA	240 A	120 A	80 A	40 A
PCR 30000WE2	30 kVA	20 kVA	300 A	150 A	100 A	50 A
PCR 36000WE2	36 kVA	24 kVA	360 A	180 A	120 A	60 A

The PCR-WE2 consists of three power modules.

Model	1P output	1P3W / 3P output		
		U phase	V phase	W phase
PCR3000WE2	3 kVA	1 kVA	1 kVA	1 kVA
PCR6000WE2	6 kVA	2 kVA	2 kVA	2 kVA
PCR12000WE2	12 kVA	4 kVA	4 kVA	4 kVA
PCR18000WE2	18 kVA	6 kVA	6 kVA	6 kVA
PCR24000WE2	24 kVA	8 kVA	8 kVA	8 kVA
PCR30000WE2	30 kVA	10 kVA	10 kVA	10 kVA
PCR36000WE2	36 kVA	12 kVA	12 kVA	12 kVA

During single-phase output and three-phase output, all power modules are used.

During single-phase three-wire output, the W-phase power module is not used.

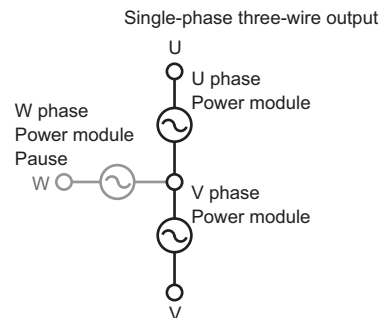
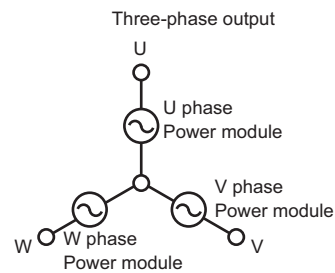

Features

The PCR-WE/PCR-WE2 is equipped with the following functions.

Switchable between single-phase output, single-phase three-wire output, and three-phase output (PCR-WE2 only)

Three types of output are available on a single unit.

Power regeneration function (PCR-WE2R only)

Load power can be regenerated on the AC line. In a typical inverter system, unconsumed power is regenerated on the AC line. If you use the PCR-WE2R as a power system simulator, you do not need a regenerative load. This helps to suppress the level of exhaust heat and saves energy.

Various power supply simulations

Power line abnormalities such as voltage dips and short power interruptions can be simulated. This is a basic function for power-supply-environment testing.

Various measurements

The rms voltage and current, the peak voltage and current, the active power, apparent power, and power factor of the output can be measured. Harmonic analysis (0th to 50th) can be performed on the output voltage and current.

DC output

DC output and AC+DC output are possible in addition to AC output. This makes it possible to use the PCR-WE in a wide variety of fields, such as chemistry and physics.

Sequence function

The output voltage, frequency, and waveform can be changed over time. Power-supply-environment testing can be automated.

In addition to the AC output sequences, DC output and AC+DC output sequences are also available. A variety of standard tests can also be performed.

Sensing function and regulation adjustment function

Even if the load device is at a remote location, the PCR-WE/PCR-WE2 can stabilize the voltage across the load by correcting for voltage drops.

There are two types of sensing: hard sensing and soft sensing. The different types of sensing are used depending on the load conditions and how you will use the PCR-WE.

Output current control

The current limit function can be used to limit the output current (rms) to a fixed value to perform continuous operation. Continuity tests on electrical equipment (such as switchboards, breakers, and wiring devices) can be performed under stable conditions.

Power management function (power conservation function)

A sleep function, which turns the power modules off to reduce power consumption when output is not generated for the specified length of time, and a power-saving function, which operates the power modules at the bare minimum settings as required by the supply load, are available.

Memory function

Up to 3 entries of output frequency, voltage (AC and DC), and waveform bank settings can be saved to the internal preset memory.

Up to 10 entries of panel settings can be saved to the internal setup memory.

The internal memory, panel settings, power line abnormality simulations, sequence data, and waveform bank data can be saved to a USB memory device.

External communications

The PCR-WE/PCR-WE2 can be controlled remotely through its USB, LAN, and RS232C interfaces. If an optional interface board is used, the PCR-WE Series can be controlled remotely through a GPIB interface.

External analog signal control

The output can be controlled using external analog signals.

Contents

About Manuals	2
Open Source Software	2
Notations Used in This Document	3
Checking the Package Contents	3
Safety Precautions	4
Precautions When Choosing the Installation Location	4
Moving the Product	4
Product Overview	5
Component Names	10

Installation

Connecting the Power Cord	16
Connecting the PCR1000WE/PCR2000WE/ PCR3000WE2	19
Connecting the PCR6000WE2/PCR12000WE2... ..	20
Connecting the PCR18000WE2/PCR24000WE2/ PCR30000WE2/PCR36000WE2	22
Turning the Power On	24
Preventing the shutdown function from activating	24
Turning the POWER switch on	25
Setting the condition that the product will be in when the POWER switch is turned on	26
Turning the POWER switch off	26
Connecting the Load	27
Connecting to the OUTPUT terminal block	28
Connecting the PCR1000WE/PCR2000WE	29
Connecting the PCR3000WE2	30
Connecting the PCR6000WE2/PCR12000WE2... ..	32
Connecting the PCR18000WE2/PCR24000WE2/ PCR30000WE2/PCR36000WE2	34

Basic Functions

Panel Operation Basics	37
Control panel	37
Parts of the screen	39
Explanation of function keys in this manual	40
Home position	40
Canceling settings	40
Waiting for confirmation	40
Busy status	41
Returning the product to the factory default settings	41

Switching from remote mode to local mode	41
Displaying single-phase three-wire output and three- phase output (PCR-WE2 only)	42
Specifying values	44
Adjusting the screen brightness	45
Viewing the firmware version	46
Locking panel operations (key lock)	46
Selecting the Output Method	47
Setting the Output Voltage	48
Setting the output voltage range	48
About setting the output voltage	49
Output voltage setup procedure for single-phase out- put	51
Output voltage setup procedure for single-phase three-wire output	51
Output voltage setup procedure for three-phase out- put	53
Setting the voltage offset	54
Setting the Frequency	55
Turning the Output On/Off	56
Impedance when the output is off	57
Voltage surge suppression when the output is turned off	58
Output on/off phase control	59
AC coupling	60
Measurement Display	61
Displaying the voltage	61
Load level meter	63
Displaying the current, power, and power factor ..	64
Limit Function and Protection Function	66
Setting Limits	67
Upper and lower voltage limits	67
Upper and lower frequency limits	68
Current limit and peak current limits	68
Using Protection Functions	72
Using the Memory	74
Items that can be saved	74
Using internal preset memory	75
Setting the date and time (time zone)	77
Using the internal setup memory	78
Using a USB memory device	79

Advanced Functions

Using the Sync Function	84
Using the Compensation (Voltage compensation)	

Function.....	86
Wiring the hard sensing and soft sensing functions ..	88
Wiring the regulation adjustment function	92
Compensation function setup procedure	93
Ending the use of the compensation function	96
Using Power Line Abnormality Simulations.....	97
Power line abnormality simulation setup procedure..	99
Executing and stopping power line abnormality simu-	
lations.....	100
Using the Harmonic Analysis Function.....	101
Generating Special Waveforms (Waveform bank)	
102	
Setting the waveform bank.....	103
Generating special waveforms	104
Setting the Output Impedance.....	105
Configuring Soft Start and Soft Stop	106
Configuring soft start.....	106
Configuring soft stop	107
Selecting the Response.....	108
Using the Power Management Functions.....	109
Sleep function	109
Power-saving function.....	110
Power module management function.....	111

Sequence Function

Sequence Overview	112
Editing Steps	117
Common items	117
[1] Frequency and AC voltage.....	118
[2] Execution time, waveform bank	119
[3] DC voltage, output	120
[4] Status output, trigger output, trigger input (pause)	
121	
[5] Jump function.....	123
[6] Starting phase angle, ending phase angle, sud-	
den phase change.....	124
[7] Output impedance (for single-phase output)..	125
[7] Output impedance (for single-phase three-wire	
output and three-phase output, resistance compo-	
nent).....	125
[8] Output impedance (for single-phase three-wire	
output and three-phase output, reactance compo-	
nent).....	125
[9] Phase difference for three-phase output.....	126
Setting Sequence Conditions	128
Executing, Pausing, and Stopping Sequences....	
129	
Sequence Creation Tutorial.....	130
Sequence creation basics	132

Voltage sweep and frequency sweep	135
Switching steps at specific phase angles.....	137
Suddenly changing the phase.....	140
Single-phase three-wire output and three-phase out-	
put basics.....	142
Phase setting for multi-phase output	143
Phase sweep	147
Line voltage dip.....	149

External Control

Control Using Analog Signals.....	152
ANALOG IN connector pin arrangement	153
Selecting the parameter to control	154
Amplifying the input waveform (EXTDC mode) ..	155
Varying the output voltage or frequency using DC sig-	
nals (VPROG mode).....	158
Control Using Digital Signals.....	162
DIGITAL I/O connector pin arrangement and map-	
ping	163
Controlling the PCR-WE through external contacts..	
166	
Monitoring the operation status.....	171
Selectable I/O	174
Selectable signals when INP.SIG is selected	176
Selectable signals when OUTP.SIG is selected ..	176

Parallel Operation

Configuring the Master and Slave Units.....	178
Installation and Connection.....	179
Installation.....	179
Connecting PCR-WEs together	179
Turning the Power On and Checking the Opera-	
tion.....	183
Connecting the OUTPUT terminal block and relay	
terminals	183
Turning the power on.....	184
Operation Check.....	184
Connecting the Load	185
Ending parallel operation.....	186

System Settings

Setting the Watchdog Protection (WDP).....	187
Displaying/Changing the Interface Settings ...	188
Controlling the PCR-WE/WE2 from a PC	188
Displaying SCPI Errors.....	189
Factory Default Settings and Reset Settings..	190

Factory default settings	191
Updating	196

Maintenance

Cleaning the Dust Filter	197
Backup Battery Replacement	199
Calibration	199

Specifications

Main Unit Specifications	200
Input (AC rms)	201
Output	203
Output voltage stability (phase voltage)	204
Measurement	205
Limit values and protection functions	206
Power line abnormality simulations	207
Sequence operations	207
Special waveform output	207
Output impedance setting	208
Output on/off phase setting	208
Communication interface	209
Signal I/O	210
Parallel operation (PCR1000WE/ PCR2000WE/ PCR3000WE2 excluded)	214
Memory	214
Sync function	214
Compensation function	214
Response selection function	215
Ecological function	215
Soft start and soft stop functions	215
LIN, DSI connection I/O	215
General	216
Rated output current characteristics (derating) ..	218
Outline Drawing	219

External Control Connector	230
Rack Mount Brackets	230
GPIB interface board (IB07-PCR-WE)	234
Base hold angles (OP03-KRC)	235
Parallel operation cables (PC01-PCR-WE, LC01- PCR-LE)	235
Troubleshooting	236
Alarms and Trouble	239
Overview	239
Remedy	240
Error Messages	243
Index	245

Appendix

Terminology	222
Power Regeneration Function (PCR-WE2R only) 225	
Output and Load	226
Rated output current for AC output	226
AC output voltage frequency response	228
Frequency response for analog input	228
Options	229
Input power cords	229

Component Names

Front panel

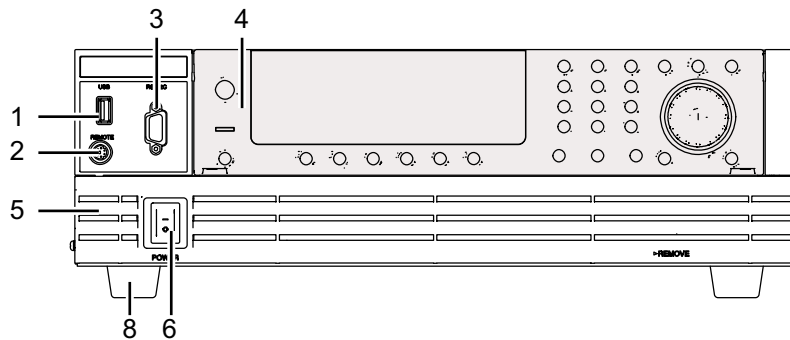

PCR1000WE
PCR2000WE
PCR3000WE2

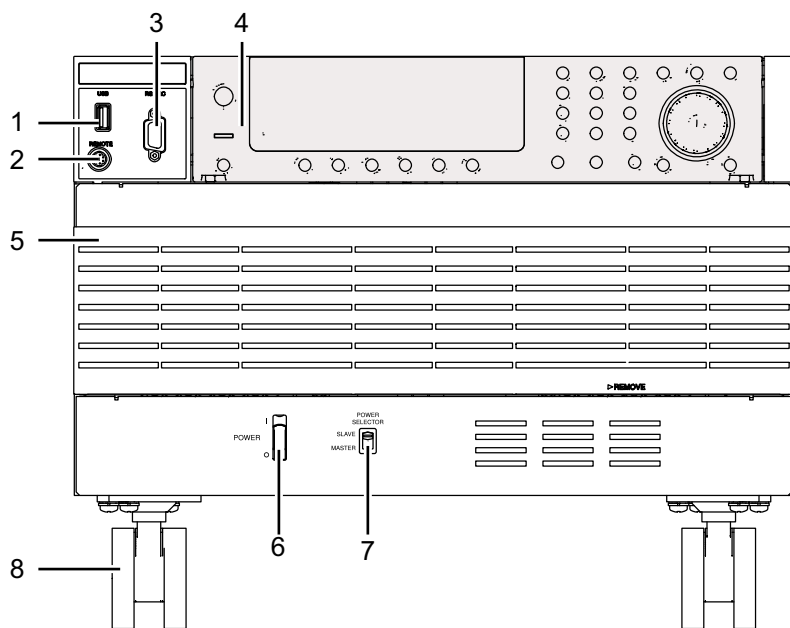

PCR6000WE2
PCR12000WE2
PCR18000WE2
PCR24000WE2
PCR30000WE2
PCR36000WE2
(PCR6000WE2 example)

No.	Name	Function	See
1	USB port (host)	Connects to an external keyboard. Saves to setup memory. Used for updating.	See p.79 p.196
2	REMOTE connector	Connector for the optional line impedance network or dip simulator.	—
3	RS232C port	RS232C port for remote control.	—
4	Control panel	Operation panel and display.	p.11
5	Power module air inlet	Inlet holes for cooling.	—
6	POWER switch	Flip the switch to the I side to turn the power on and to the O side to turn it off.	p.24
7	POWER SELECTOR switch	Power on/off sync switch for parallel operation.	p.181
8	Caster and leg	4 locations.	p.4

Control panel

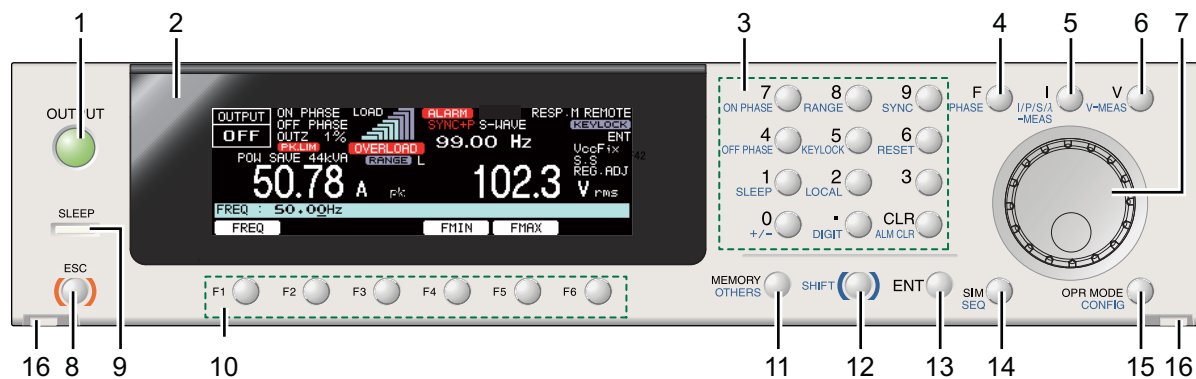





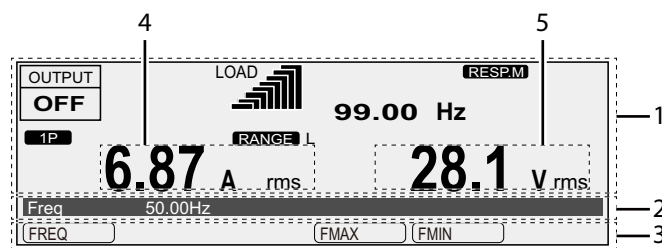



























No.	Name	Function	See
1	OUTPUT	Turn the output on and off.	p.56
2	Display	Displays the settings, measured values, and other information.	p.61
3	Numeric keypad	Enters values directly.	p.44
	CLR key	Clears the input entered with the numeric keypad.	
	ON PHASE key	Sets the output-on phase.	p.59
	RANGE key	Changes the output voltage range.	p.48
	SYNC key	Sets the sync function.	p.84
	OFF PHASE key	Sets the output-off phase.	p.59
	KEYLOCK key	Locks or unlocks the keys.	p.46
	RESET key	Resets the product.	p.190
	SLEEP key	Sets the sleep function.	p.109
	LOCAL key	Switches to local mode from remote mode.	p.41
	+/- key	Changes the voltage polarity of the DC output.	p.44
	DIGIT key	Moves to the left digit when setting a value.	p.45
	ALM CLR key	Clears the alarm.	p.72
4	F key	Sets the frequency.	p.55
	PHASE key	Switches the displayed phase during multi-phase operation. This is not available on the PCR1000WE or PCR2000WE.	p.42
5	I key	Set the current parameters.	p.68
	I/P/S/λ-MEAS key	Switches between current, power, and power factor displays.	p.64
6	V key	Sets voltage parameters.	p.48
	V-MEAS key	Switches the voltage display.	p.61
7	Rotary knob	Rotary knob.	p.44
8	ESC key	Returns to the previous level or cancels operations.	p.40
9	SLEEP LED	Blinks in sleep mode.	p.109
10	Function keys	Executes the function shown above the keys.	p.39
11	MEMORY key	Saves and recalls from memory.	p.74
	OTHER key	Sets advanced operations.	—
12	SHIFT key	Enables the functions that are written in blue characters in the bottom row to the left of each key.	p.3
13	ENT key	Confirms the settings.	p.40
14	SIM key	Sets the power line abnormality simulation.	p.97
	SEQ key	Sets the sequence operation.	p.112
15	OPR MODE key	Sets the operation.	—
	CONFIG key	Sets CONFIG parameters.	—
16	Control panel detachment button	Detaches the control panel (two locations).	p.37

Display and Icons



No.	Name	Function	See	
1	Status, measured-value, and setting display area	Displays the product's present status, measured values, and settings.	p.39	
2	Entry area	Area for entering various values and system settings.		
3	Function key name area	Displays the present functions above the function keys (F1 to F6).		
4	Current, power, or power factor display	A rms	Displays the rms current	p.64
		A pk	Displays the peak current	
		A dc	Displays the average current	
		W/ kW	Displays the power	
		VA	Displays the apparent power	
		λ	Displays the power factor	
5	Voltage display	V rms	Displays the rms voltage	p.61
		V pk	Displays the peak voltage	
		V dc	Displays the average voltage	

icons	Description	See
1P	Single-phase output	p.47
1P3W	Single-phase three-wire output	
3P	Three-phase output	
AC.C	AC coupling on	p.60
ALARM	Alarm generation	p.72
Busy...	Key operation is not possible while internal processing is in progress.	p.41
ENT SHIFT+ENT	Waiting for confirmation (blinking)	p.40
ERR	There is an SCPI error.	p.189
EXT	Amplifies the input waveform using an external signal.	p.155
EXTSYNC	Lights when the external sync function is in use. Blinks until synchronization is established.	p.84
EXTSYNCNG	Unable to sync to the external sync input signal.	
EXTSYNC+P	Lights when the external sync function is in use (with the delay phase angle set). Blinks until synchronization is established.	
FALL TIM	Soft stop on	p.107
INT+EXT	Amplifies the input waveform using the internal signal and external signal.	p.155
IPK.LIM	Peak current limit activated	p.69
KEYLOCK	Keys locked	p.46

icons	Description	See
	LAN status, red: not connected, orange: connecting, green: communication possible, blinking: identify status	—
	Load level meter	p.63
	Output-off phase setting	p.59
	Output-on phase setting	p.59
	Output on	p.56
	Output off “OFF” blinks when soft stop is in use.	p.56 p.106
	Output off, voltage surge suppression function on	p.58
	Output impedance setting	p.105
	Overload occurrence	p.70
	Power save mode	p.110
	Output voltage range	p.48
	Compensation: regulation adjustment	p.86
	Waiting for reset confirmation or reset in progress	p.190
	Response: High speed (FAST)	p.108
	Response: Normal speed (MEDIUM)	
	Response: High stability (SLOW)	
	The soft start function is turned on.	p.106
	Remote mode	p.41
	Soft sensing control error	p.86
	Compensation: hard sensing	p.86
	Compensation: soft sensing (displayed in red when compensation cannot be completed)	
	Lights when the sync function is in use. Blinks until synchronization is established.	p.84
	Lights when the sync function is in use (with the delay phase angle set). Blinks until synchronization is established.	
	Lights when synchronization cannot be established with the input power supply.	
	Non-zero waveform bank number	p.102
	The action taken when the current limit is exceeded is set to trip (output not turned off).	p.70
	Sequence ended with the U phase offset	p.53
	Unbalanced phase difference	p.42
	Unbalanced phase difference and voltage	
	Unbalanced voltage	
	All phase (phase voltage) display for three-phase output or single-phase three-wire output	p.42
	All phase (line voltage) display for three-phase output or single-phase three-wire output	

Rear Panel

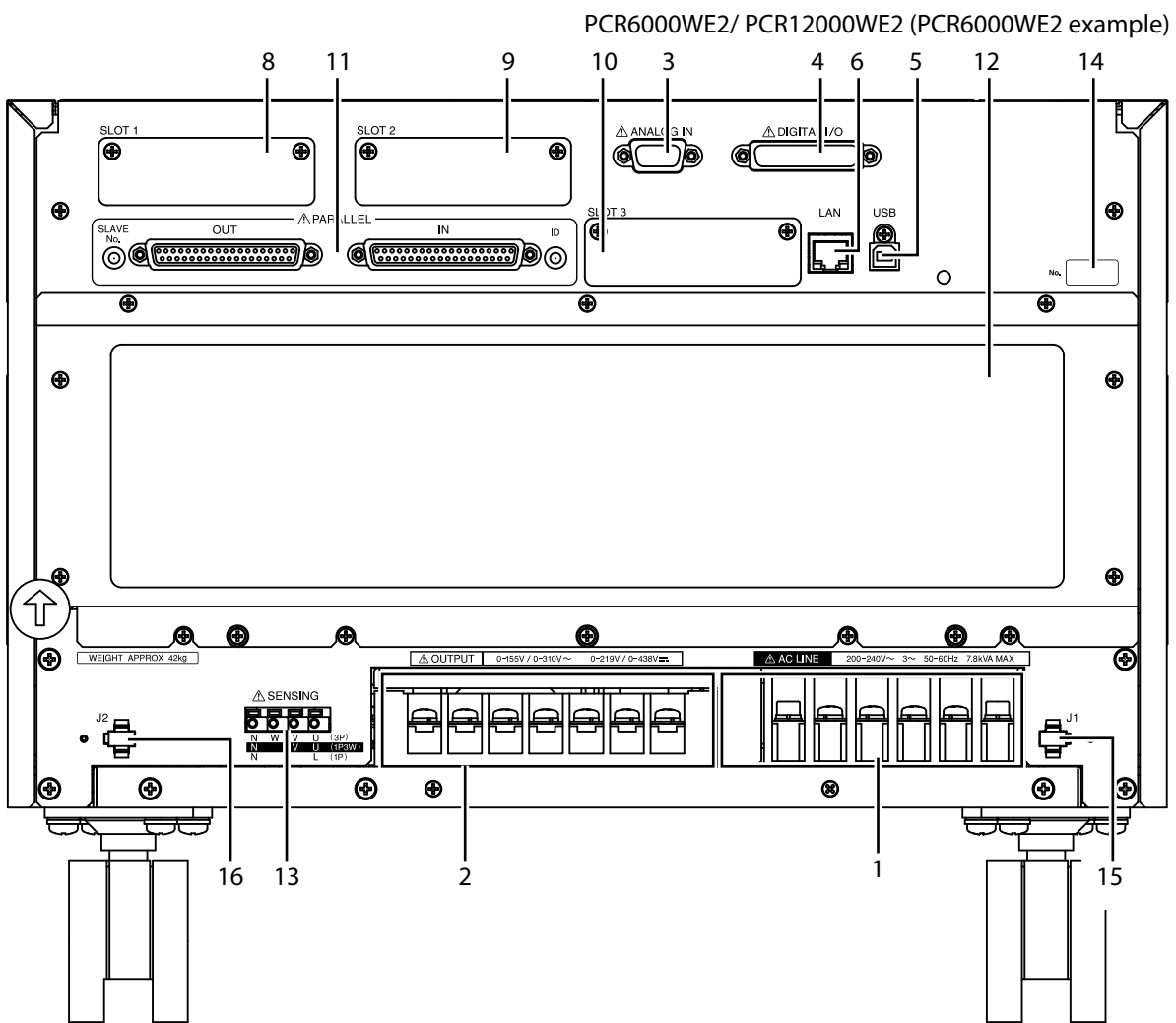
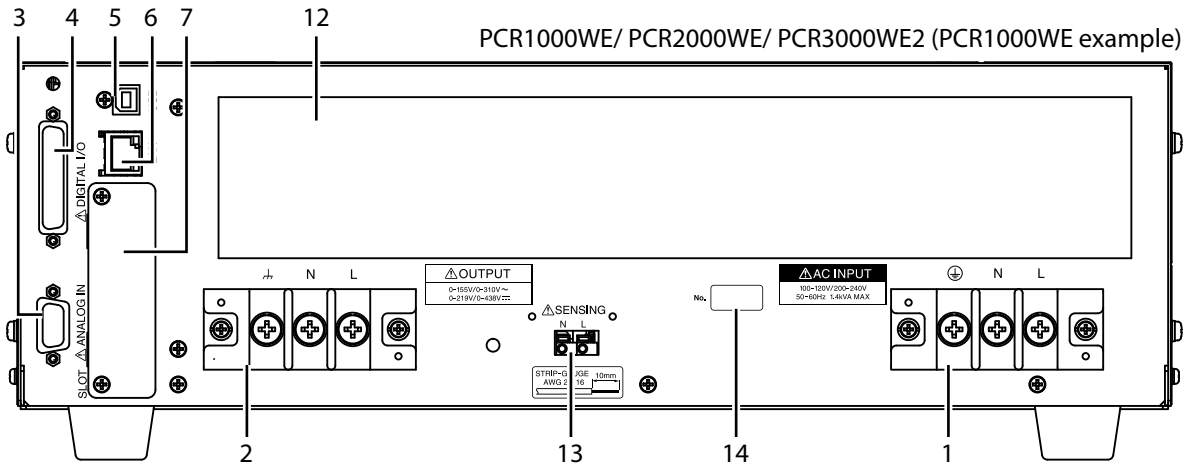

PCR18000WE2/ PCR24000WE2/
PCR30000WE2/ PCR36000WE2 (PCR36000WE2 example)

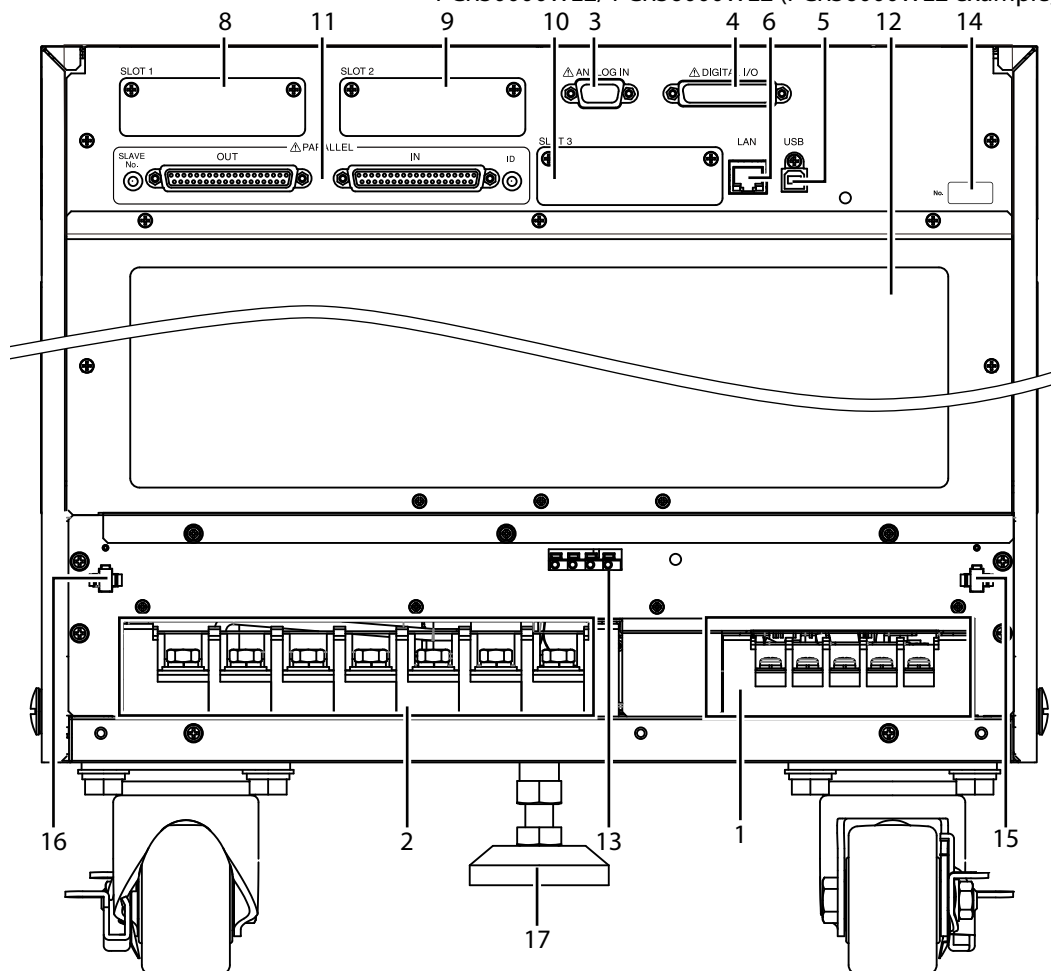

No.	Name	Function	See
1	AC INPUT terminal block	Power inlet with a cover.	p.16
2	OUTPUT terminal block*1	Output terminal block with a cover	p.27
3	ANALOG IN connector	Analog control connector	p.152
4	DIGITAL I/O connector	Digital control connector.	p.162
5	USB port (device)	USB port for remote control.	—
6	LAN port	LAN port for remote control.	—
7	SLOT	Expansion slot (PCR1000WE, PCR2000WE, PCR3000WE2 only)	—
8	SLOT1	Expansion slot (PCR-WE2 (excluding PCR3000WE2) only)	—
9	SLOT2	—	—
10	SLOT3	—	—
11	PARALLEL connector	Parallel operation connector (PCR-WE2 (excluding PCR3000WE2) only)	p.179
12	Power module air outlet	Vent for cooling the <series name>.	—
13	SENSING terminal block	Connect the sensing cables. The PCR1000WE, PCR2000WE, and PCR3000WE have a cover.	p.86
14	Serial number	PCR-WE/PCR-WE2 serial number.	—
15	J1 connector	Power sync connector for parallel operation (PCR-WE2 (excluding PCR3000WE2) only)	p.181
16	J2 connector	—	—
17	Stopper	Stopper for fixing the product to the floor (PCR18000WE2, PCR24000WE2, PCR30000WE2, and PCR36000WE2 only)	p.4

*1. The PCR3000WE2 is shipped from the factory with a short bar attached.

Installation

Connecting the Power Cord

This product is designed as an equipment of IEC Overvoltage Category II (energy-consuming equipment supplied from a fixed installation).



WARNING

Risk of electric shock.

- This product is IEC Safety Class I equipment (equipment with a protective conductor terminal). To prevent electric shock, be sure to connect the protective conductor terminal of the product to electrical ground (safety ground).
- Connect the protective conductor terminal to earth ground.
- Before you connect the power cord, turn off the switchboard breaker (a switch that cuts off the power supply from the switchboard).
- Do not use the terminal block with the terminal cover removed.
- Be sure to have a qualified engineer connect the power cable to the switchboard.
- The switchboard breaker must meet the requirements shown below.
- If this distance needs to be more than 3 m, connect the cable by inserting a separate circuit breaker within 3 m of the product. For the circuit breaker, use a type that can cut off the L and N wires or R, S, T, and N wires simultaneously.
- Use cables with a rated voltage of 600 V or higher.

Risk of fire

- Use a power cord whose capacity is adequate for the input current and with sturdy, flame-resistant insulation.



CAUTION

- If the voltage distortion of the AC power line is large, the product may malfunction. The product cannot be connected to a generator or a similar device.
- Inside the product, protective circuits such as input fuses are connected to match the polarity of the input terminal. Be sure to connect the wires correctly between the switchboard and the input terminals of the product.

Single-phase 200 V input: L, N, and \ominus (GND)

Three-phase 200 V input: R, S, T, and \ominus (GND)

Three-phase 400 V input: R, S, T, N, and \ominus (GND)

- Risk of heat buildup or spark emission. Fasten the wires securely at the recommended torque.



NOTE

In an emergency, turn off the switchboard breaker to separate the product from the AC power line.

A power cord is not included with this product.

Input power cords are available as options. When you are wiring the switchboard, attach crimping terminals that match the screws of the switchboard.

If you will not use one of the optional input power cords, prepare a power cord that meets the following specifications.

		Cable	Nominal cross-sectional area ^{*1}	Maximum input current	Input terminal
PCR1000WE	Single-phase 200 V input	Single core, 3 pcs.	5.5 mm ² or more	17 A	M6
PCR2000WE	Single-phase 200 V input	Single core, 3 pcs.	5.5 mm ² or more	32 A	M6
PCR3000WE2	Single-phase 200 V input	Single core, 3 pcs.	14 mm ² or more	48 A	M6
PCR6000WE2	Three-phase 200 V input	Single core, 4 pcs.	5.5 mm ² or more	27 A	M5
	Three-phase 400 V input	Single core, 5 pcs.	5.5 mm ² or more	14 A	M5
PCR12000WE2	Three-phase 200 V input	Single core, 4 pcs.	14 mm ² or more	53 A	M5
	Three-phase 400 V input	Single core, 5 pcs.	5.5 mm ² or more	28 A	M5
PCR18000WE2	Three-phase 200 V input	Single core, 4 pcs.	22 mm ² or more	80 A	M8
	Three-phase 400 V input	Single core, 5 pcs.	8 mm ² or more	42 A	M5
PCR24000WE2	Three-phase 200 V input	Single core, 4 pcs.	38 mm ² or more	106 A	M8
	Three-phase 400 V input	Single core, 5 pcs.	14 mm ² or more	56 A	M5
PCR30000WE2	Three-phase 200 V input	Single core, 4 pcs.	60 mm ² or more	133 A	M8
	Three-phase 400 V input	Single core, 5 pcs.	22 mm ² or more	70 A	M5
PCR36000WE2	Three-phase 200 V input	Single core, 4 pcs.	60 mm ² or more	159 A	M8
	Three-phase 400 V input	Single core, 5 pcs.	22 mm ² or more	84 A	M5

*1. For 60 mm² or more, using a cable complying with UL1284 rating 600 V 105 °C is assumed. For others, using a cable complying with UL1015 rating 600 V 105 °C is assumed. Consider the loss due to the current reduction factor (depending on the ambient temperature and cable laying), make sure that the maximum input current of the cable is not exceeded.

■ Tightening torque of input terminal connecting screws

The recommended and upper limit values are for when attaching the cable and short bar. Use within the upper limit.

	Recommended [N•m]	Upper limit [N•m]
M5	2.0	2.4
M6	2.5	3.0
M8	5.5	6.6

■ **Switchboard breaker requirements**

- Rated current:

The circuit breaker of which the rated current is more than the following current is disabled for safety.

PCR1000WE: 30 A (100 V system), 15 A (200 V system)

PCR2000WE: 50 A (100 V system), 30 A (200 V system)

PCR3000WE2: 75 A (100 V system), 40 A (200 V system)

PCR6000WE2: 50 A (three-phase three-wire input model), 30 A (three-phase four-wire input model)

PCR12000WE2: 75 A (three-phase three-wire input model), 40 A (three-phase four-wire input model)

PCR18000WE2: 125 A (three-phase three-wire input model), 60 A (three-phase four-wire input model)

PCR24000WE2: 150 A (three-phase three-wire input model), 75 A (three-phase four-wire input model)

PCR30000WE2: 175 A (three-phase three-wire input model), 100 A (three-phase four-wire input model)

PCR36000WE2: 200 A (three-phase three-wire input model), 125 A (three-phase four-wire input model)

- Only use the breaker with this product.
- Keep the breaker readily accessible at all times.
- Indicate that the circuit breaker is dedicated for use with this product and that it is used to disconnect the product from the AC power line.

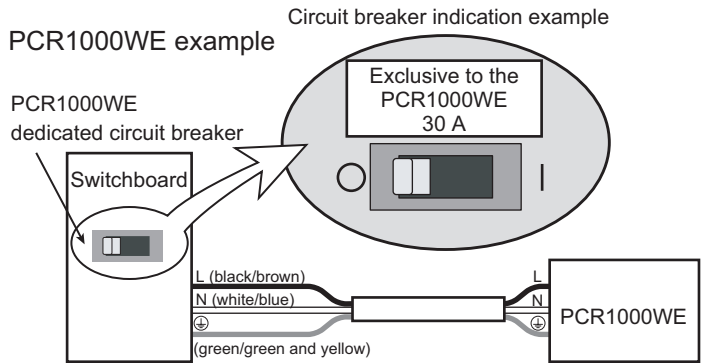

Connecting the PCR1000WE/PCR2000WE/PCR3000WE2

- 1** Turn off the switchboard's circuit breaker.
- 2** Check that the AC power line meets the nominal input rating of the product.
Acceptable input voltage (any nominal supply voltage in the following ranges):
Single-phase 100 V input: 100 Vac to 120 Vac
Single-phase 200 V input: 200 Vac to 240 Vac
Frequency: 50 Hz or 60 Hz
- 3** Turn the POWER switch off (O).
- 4** Unfasten the two M3 screws from the AC INPUT terminal cover, and remove the cover.

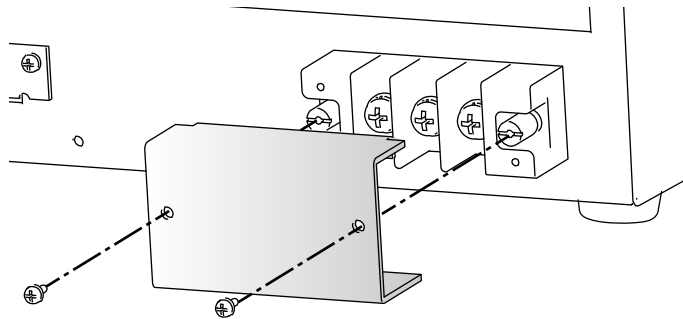

- 5** Connect the power cord according to the indications on the terminal block.

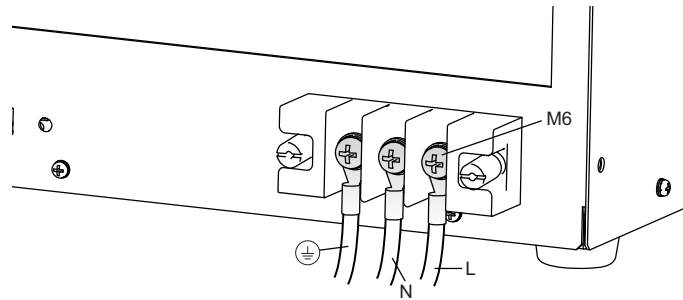

- 6** Fasten the cover that you removed in step 4 with the two screws.
- 7** Connect the power cord according to the indication on the switchboard.
- 8** Turn on the switchboard's breaker.
This completes the connections.

Connecting the PCR6000WE2/PCR12000WE2

- 1 Check that the AC power line meets the nominal input rating of the product.**
Acceptable input voltage (any nominal supply voltage in the following ranges):
Three-phase 200 V input: 200 Vac to 240 Vac (line voltage)
Three-phase 400 V input: 380 Vac to 480 Vac (line voltage)
Frequency: 50 Hz or 60 Hz
- 2 Turn the POWER switch off (O).**
- 3 Unfasten the three M4 screws from the terminal block cover, and remove the cover.**

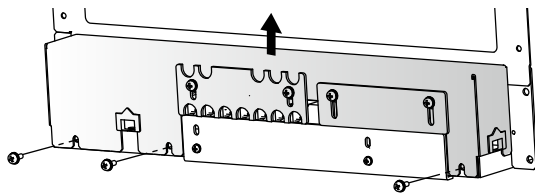

Example of PCR6000WE2 three-phase

- 4 Connect the power cord according to the indications on the AC INPUT terminal block.**

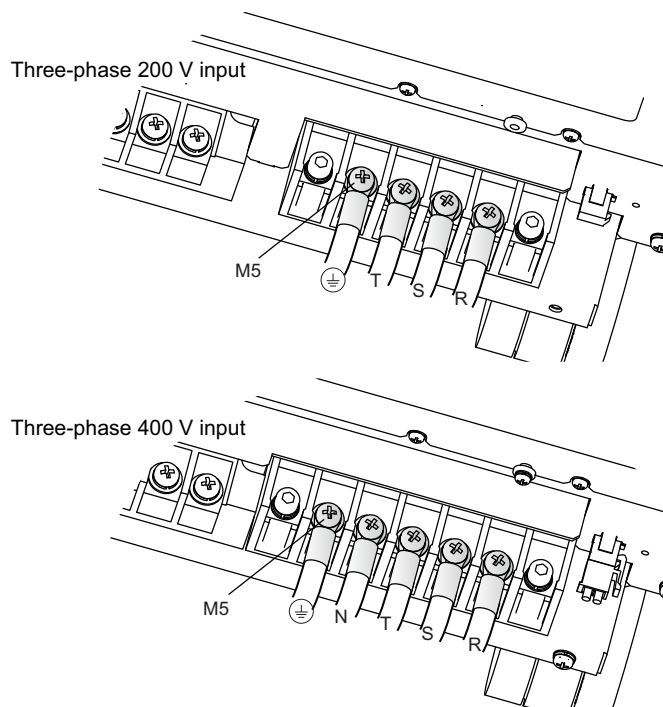

- 5** Unfasten the two M4 screws from the bottom terminal block cover, and remove the cover.

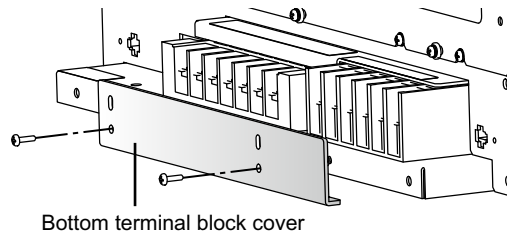

- 6** Change the direction of the bottom terminal block cover, and attach it. This will keep the crimping terminals from being exposed.

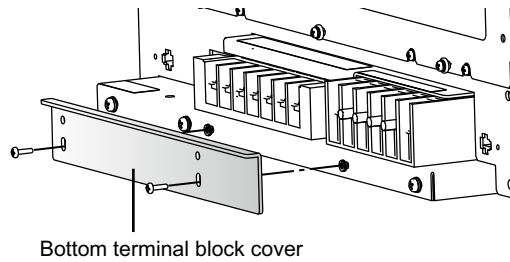

- 7** Turn off the switchboard's circuit breaker.
- 8** Connect the power cord according to the indication on the switchboard.
- 9** Loosen the two screws until the INPUT terminal cover can move.

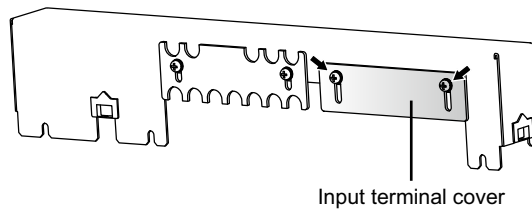

- 10** Fasten the terminal cover you removed in step 3 with the three screws.
- 11** Slide the INPUT terminal cover until it touches the wires, and then fasten the screws.

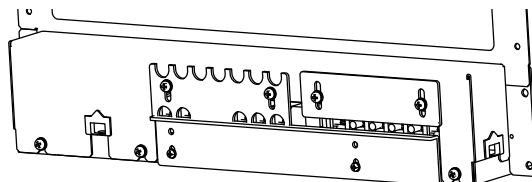

- 12** Turn on the switchboard's breaker. This completes the connections.

Connecting the PCR18000WE2/PCR24000WE2/ PCR30000WE2/PCR36000WE2

- 1 Check that the AC power line meets the nominal input rating of the product.**
Acceptable input voltage (any nominal supply voltage in the following ranges):
Three-phase 200 V input: 200 Vac to 240 Vac (line voltage)
Three-phase 400 V input: 380 Vac to 480 Vac (line voltage)
Frequency: 50 Hz or 60 Hz
- 2 Turn the POWER switch off (O).**
- 3 Unfasten the three M4 screws from the terminal block cover, and remove the cover.**

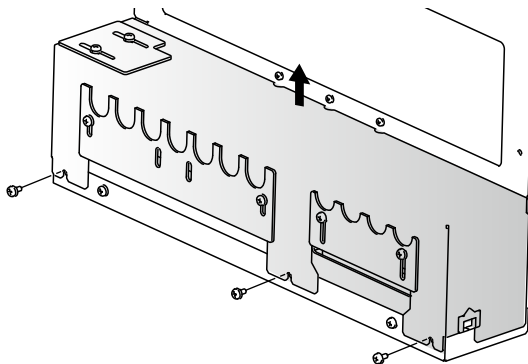

Example of three-phase 400 V input

- 4 Connect the power cord according to the indications on the AC INPUT terminal block.**

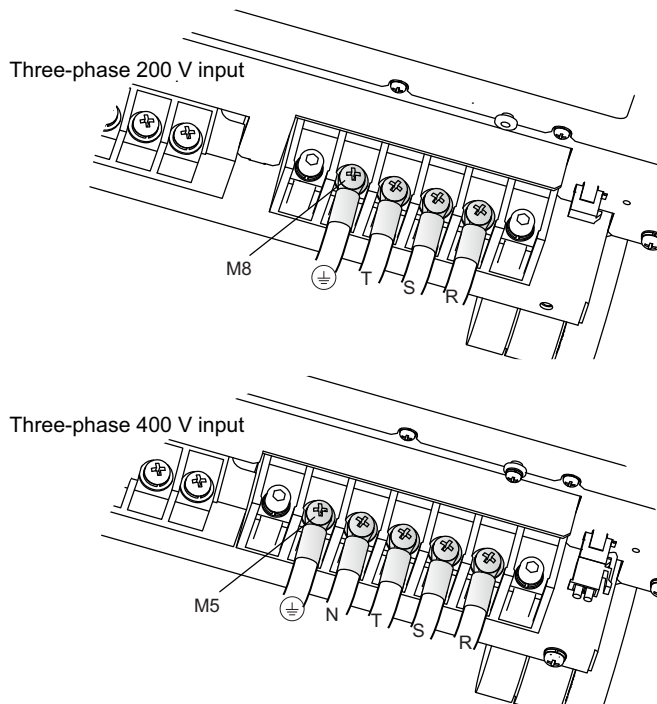

- 5 Turn off the switchboard's circuit breaker.**

6 Connect the power cord according to the indication on the switchboard.

7 For the three-phase 200 V input model (excluding the PCR36000WE2), remove the two M3 screws, change the orientation of the INPUT terminal cover, and fasten with the screws you just removed.

Tighten the screws loosely so that the INPUT terminal cover can still be moved.

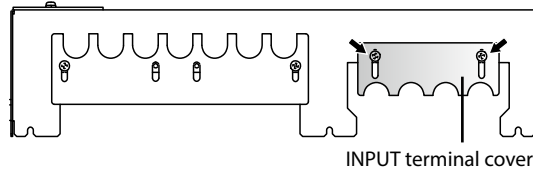

For three-phase 400 V input model or PCR36000WE2 (three-phase 200 V input), loosen the two M3 screws until the INPUT terminal cover can move.

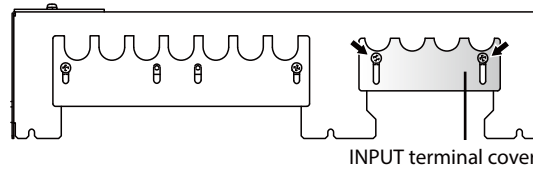

8 Fasten the terminal cover you removed in step 3 with the three screws.

9 Slide the INPUT terminal cover until it touches the wires, and then fasten the screws.

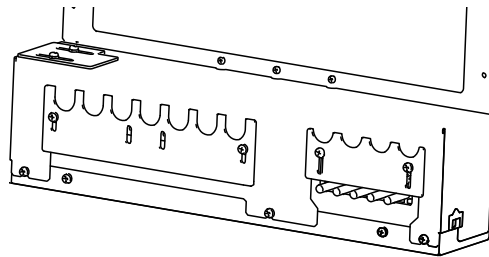

Example of PCR36000WE2 (three-phase 400 V input)

10 Turn on the switchboard's breaker.

This completes the connections.

Turning the Power On

When you turn on the POWER switch for the first time after purchase, do it without any load connected in order to check the status of the product.

Preventing the shutdown function from activating

Connect the included external control (DIGITAL I/O) connector to the DIGITAL I/O connector to release the shutdown function (p.166 , p.170).

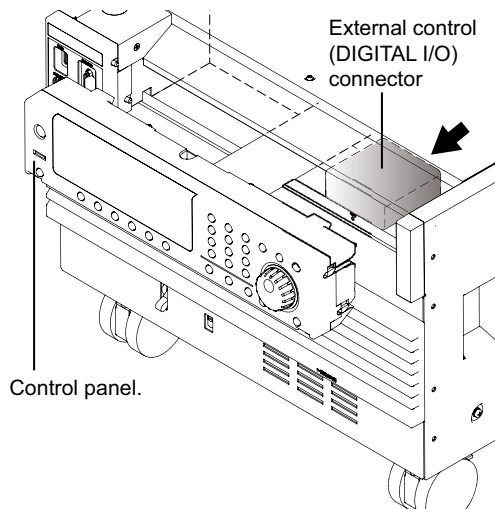

When shipped from the factory, the PCR6000WE2, PCR12000WE2, PCR18000WE2, PCR24000WE2, PCR30000WE2, and PCR36000WE2 have connectors stored on the back of the control panel.

If you turn on the POWER switch without connecting the connector, you will not be able to turn the output on because the shutdown function will be activated.

Turning the POWER switch on

- 1** Check that nothing is connected to the **OUTPUT** terminal block on the rear panel.
- 2** Check that the power cord is connected correctly.
- 3** Check whether the supplied external control connector is connected to the **DIGITAL I/O** connector on the rear panel.
- 4** Check that the **POWER SELECTOR** switch is set to "**MASTER.**"
- 5** Flip the **POWER** switch to the **(I)** side to turn the **PCR-WE** on.

The firmware version is displayed for a few seconds. If no errors are detected, the home position (basic screen) appears.

This completes the power-on procedure.



If the **POWER** switch is turned on for the first time after purchase, the product starts in the factory default condition. When the power is turned on the next time, the product starts with the settings that were in use the last time that the **POWER** switch was turned off. You can set the condition that the product will be in when the power is turned on.

If an alarm number or trouble number is displayed, see "Alarms and Trouble" ([p.239](#)).

Setting the condition that the product will be in when the POWER switch is turned on

In the factory default condition, when you turn the POWER switch on, the product starts in the same state as it was in the last time it was turned off (the output set to off). You can set the condition that the product will be in when the POWER switch is turned on.

Press CONFIG (SHIFT+OPR MODE) > PON STAT (F3) to set the condition that the panel settings will be in when the POWER switch is turned on.

Parameter	Title	Description
RST (F1)	PowerOn State	Starts by resetting the product and with the output set to off.
RCL(F2)		Starts according to the settings registered in setup memory 0.
AUTO(F3)		Starts in the same state as the product was in the last time it was turned off. The output condition is according to PowerOn Output State.

You can set the output condition for when the power is turned on. This is invalid when the power-on state is set to RST or RCL.

Press OTHERS (SHIFT+MEMORY) > 1/2(F6) > PON OUTP (F4) to set the output condition for when the POWER switch is turned on.

Parameter	Title	Description
SAFE(F2)	PowerOn Output State	Starts with the output turned off.
FORCE(F3)		Starts with the output turned on.

Turning the POWER switch off

Flip the POWER switch to the ○ side to turn the product off.

In the factory default condition, when the POWER switch is turned on, all settings except for the output condition (OUTPUT on/off) take on the values that were in use the last time that the POWER switch was turned off.

If the POWER switch is turned off immediately after the settings have been changed, the last settings may not be stored.

CAUTION Risk of malfunction. After turning the POWER switch off, wait at least 5 seconds before turning it back on.

Turning off the POWER switch in an emergency

In an emergency, turn off the switchboard breaker to separate the product from the AC power line.

Provide adequate space around the circuit breaker so that the POWER switch can be turned off at any time.

Connecting the Load

The maximum current that this product can generate varies depending on the model. It also varies depending on the output voltage and frequency. Ensure that the output power capacity is sufficient for the load capacity. The maximum output currents (for rms output voltage of 1 V to 100 V or 2 V to 200 V and frequency greater than 40 Hz or DC) for the different models are shown in the following table.

Model	Maximum output current			
	1P output		1P3W output, 3P output	
	L range	H range	L range	H range
PCR1000WE	10 A	5 A	—	—
PCR2000WE	20 A	10 A	—	—
PCR3000WE2	30 A	15 A	10 A	5 A
PCR6000WE2	60 A	30 A	20 A	10 A
PCR12000WE2	120 A	60 A	40 A	20 A
PCR18000WE2	180 A	90 A	60 A	30 A
PCR24000WE2	240 A	120 A	80 A	40 A
PCR30000WE2	300 A	150 A	100 A	50 A
PCR36000WE2	360 A	180 A	120 A	60 A



WARNING

Risk of electric shock

- Do not use the terminal block with the terminal cover removed.
- Use load cables with a voltage rating that meets or exceeds the product's isolation voltage (± 438 V).
- Risk of electric shock. Before you connect cables to the OUTPUT terminal block, be sure to turn the POWER switch off, and then turn off the switchboard.

Risk of fire

- Use load cables whose capacity is adequate for the maximum output current and with sturdy, flame-resistant insulation.



CAUTION

- A sudden load variation exceeding the rating may cause a large overshoot.
- Risk of heat buildup or spark emission. Fasten the wires securely at the recommended torque.
- If you connect a voltage source (e.g., battery) to the load, current will flow from the load through the product and may cause the product to break or degrade the lifespan of the load. If you are going to connect a voltage source of the load, provide a switch between the product and load, match the output voltage to the load voltage, and then connect the source.

NOTE

The L and N terminals of the OUTPUT terminal block are isolated from the input power supply. The polarity does not constitute a problem in terms of safety. The polarity matters in synchro mode (in which the product is synchronized with the input power supply) and DC mode, so check the polarity of the load before you connect it to the product. You can use either L or N to ground the product.

■ **Tightening torque of output terminal connecting screws**

The recommended and upper limit values are for when attaching the cable and short bar. Use within the upper limit.

	Recommended [N•m]	Upper limit [N•m]
M5	2.0	2.4
M6	2.5	3.0
M8	5.5	6.6

Connecting to the OUTPUT terminal block

We recommend that you run the load wires alongside each other and tie them together at several points with cable ties. Connect between the output terminal and load with the shortest wires possible.

Preparing wires

Use noncombustible wires that have diameters that correspond to the output current to connect to the load.

■ **Requirements of single-core wires that are used to connect to the load**

A cable's temperature is determined by the resistive loss based on the current, the ambient temperature, and the cable's external thermal resistance. The following table shows the current capacity of heat-resistant vinyl cables that have a maximum allowable temperature of 60 °C when one of the cables is separated and stretched out horizontally in air in an ambient temperature of 30 °C. The current must be reduced under certain conditions, such as when vinyl cables that have a low heat resistance are used, when the ambient temperature is 30 °C or greater, or when cables are bundled together and little heat is radiated.

Nominal cross-sectional area [mm ²]	AWG (reference cross-sectional area) [mm ²]	Allowable current*1 [A] (at Ta = 30 °C / 86 °F)
0.9	18 (0.82)	17
1.25	16 (1.31)	19
2	14 (2.08)	27
3.5	12 (3.31)	37
5.5	10 (5.26)	49
8	8 (8.37)	61
14	6 (13.3)	88
22	4 (21.15)	115
30	2 (33.62)	139
38	1 (42.41)	162
50	1/0 (53.49)	190
60	2/0 (67.42)	217
80	3/0 (85.03)	257
100	4/0 (107.2)	298

*1. * Excerpt from Japanese laws related to electrical equipment.

For cables other than those specified in this table, consult with a qualified engineer.

Connecting the PCR1000WE/PCR2000WE

- 1** Turn the **POWER** switch off (O).
- 2** Turn off the switchboard's circuit breaker.
- 3** Unfasten the two M3 screws from the **OUTPUT** terminal cover, and remove the cover.

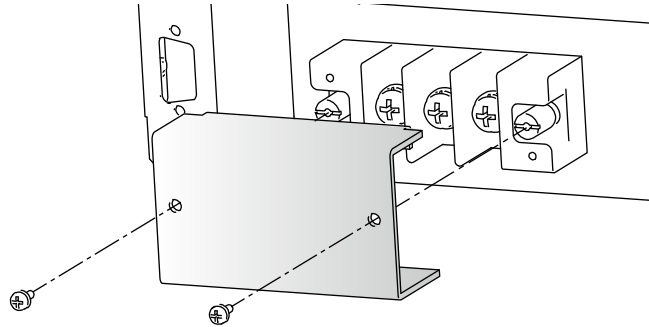

- 4** Securely connect the load cables to the **OUTPUT** terminal block.

If the load has a ground (GND) terminal, be sure to connect it to the  (ground) terminal of the product's OUTPUT terminal block. Be sure to use a wire whose diameter is greater than or equal to the diameter of the wires used to connect the load.

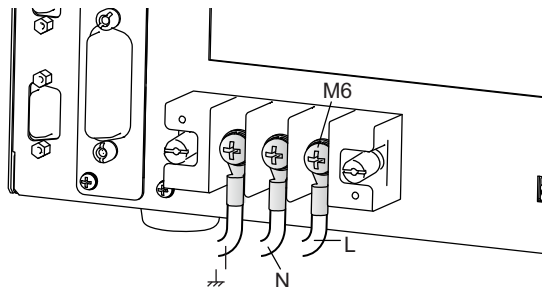

- 5** Fasten the cover that you removed in step 3 with the two screws.
This completes the connections.

Connecting the PCR3000WE2

For single-phase output

- 1** Turn the **POWER** switch off (O).
- 2** Turn off the switchboard's circuit breaker.
- 3** Unfasten the two M3 screws from the **OUTPUT** terminal cover, and remove the cover.

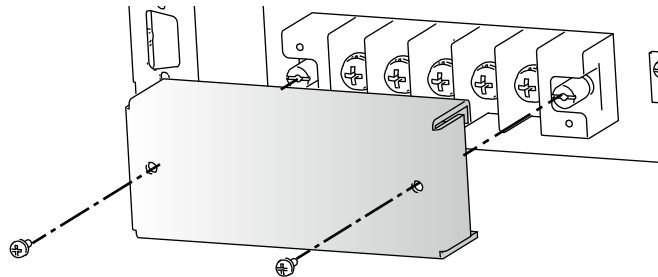

- 4** Attach the short bar.

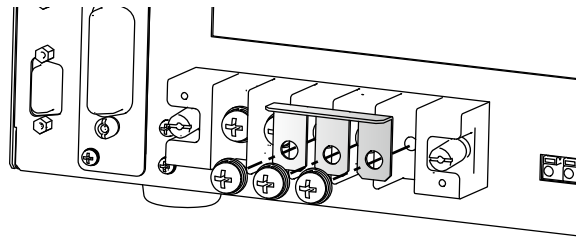

- 5** Securely connect the load cables to the **OUTPUT** terminal block.

If the load has a ground (GND) terminal, be sure to connect it to the ⚡ (ground) terminal of the product's OUTPUT terminal block. Be sure to use a wire whose diameter is greater than or equal to the diameter of the wires used to connect the load.

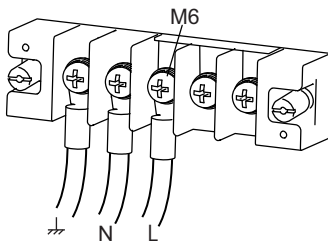

- 6** Fasten the cover that you removed in step 3 with the two screws.
This completes the connections.

For three-phase output and single-phase three-wire output

- 1** Turn the POWER switch off (O).
- 2** Turn off the switchboard's circuit breaker.
- 3** Unfasten the two M3 screws from the OUTPUT terminal cover, and remove the cover.

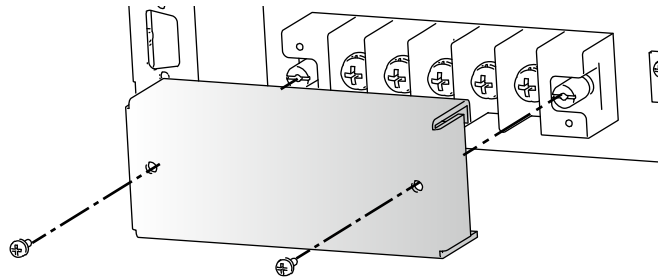

- 4** If a short bar is attached across the U, V, and W terminals, remove it.

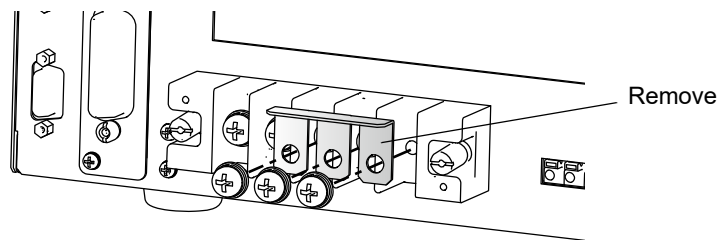

- 5** Securely connect the load cables to the OUTPUT terminal block.

If the load has a ground (GND) terminal, be sure to connect it to the ⚡ (ground) terminal of the product's OUTPUT terminal block. Be sure to use a wire whose diameter is greater than or equal to the diameter of the wires used to connect the load.

Three-phase output

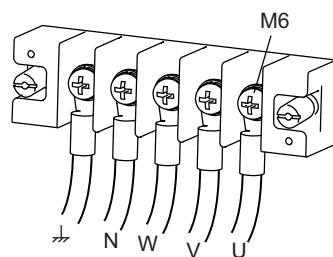

Single-phase three-wire output

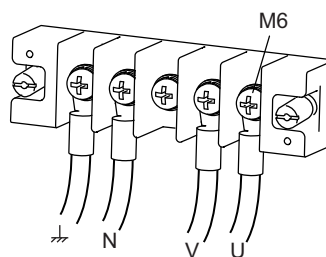

- 6** Fasten the cover that you removed in step 3 with the two screws.
This completes the connections.

Connecting the PCR6000WE2/PCR12000WE2



WARNING

Risk of electric shock.

- Attach the **OUTPUT** terminal cover so that the terminals are not exposed according to the output system.
- To use **single-phase output**, be sure to connect three cables each for **L** and **N**. There is a risk of touching the unused terminals through the gap of the **OUTPUT** terminal cover.

When the product is shipped from the factory, an **OUTPUT** terminal cover is attached to keep the **OUTPUT** terminals from becoming exposed. If you are not using the **OUTPUT** terminal block, attach the terminal cover so that the terminals are not exposed.

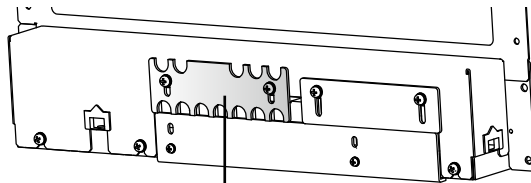

OUTPUT terminal cover

- 1** Turn the **POWER** switch off (O).
- 2** Turn off the switchboard's circuit breaker.
- 3** Unfasten the three **M4** screws from the terminal block cover, and remove the cover.

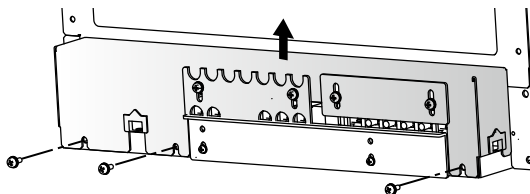

4 Securely connect the load cables to the OUTPUT terminal block.

If the load has a ground (GND) terminal, be sure to connect it to the ⚡ (ground) terminal of the product's OUTPUT terminal block. Be sure to use a wire whose diameter is greater than or equal to the diameter of the wires used to connect the load. For single-phase output, if you are using a bus bar or the like to make the connection, contact your Kikusui agent or distributor.

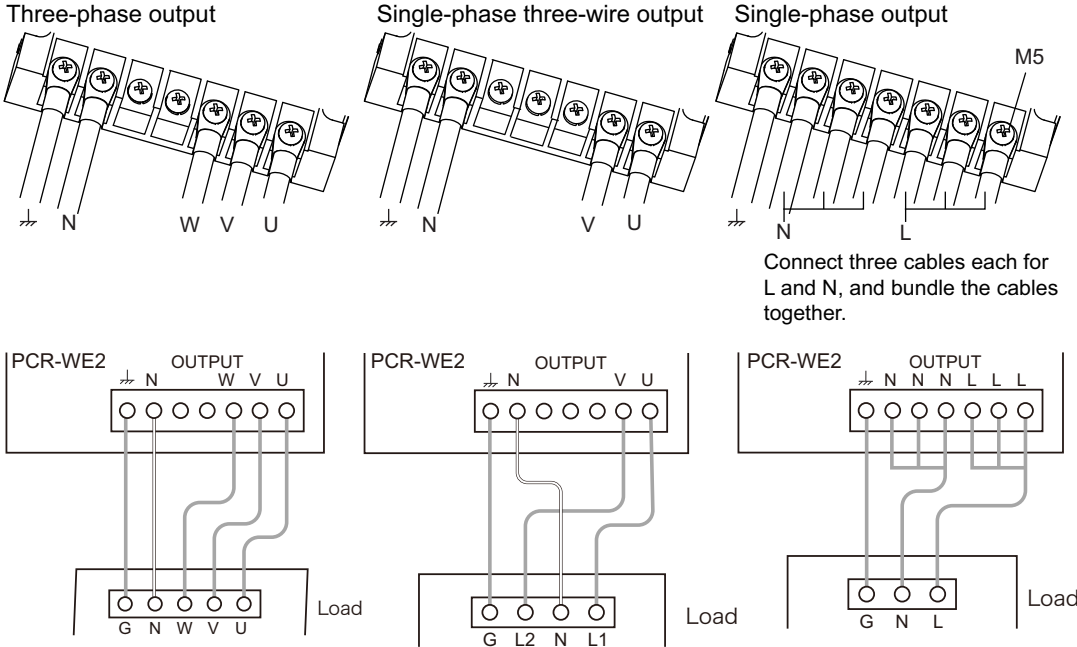

5 Adjust the OUTPUT terminal cover so that the unused terminals are not exposed.

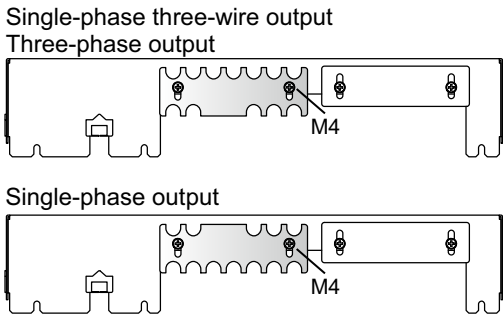

6 Fasten the terminal cover you removed in step 3 with the three screws.

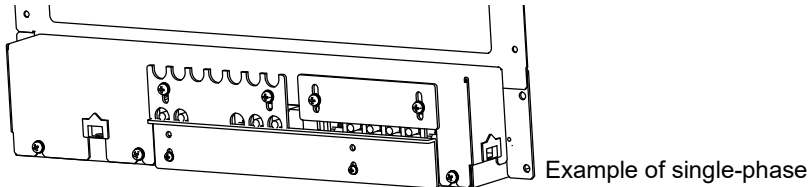

Connecting the PCR18000WE2/PCR24000WE2/ PCR30000WE2/PCR36000WE2



WARNING Risk of electric shock.

- Attach the **OUTPUT** terminal cover so that the terminals are not exposed according to the output system.
- To use **single-phase output**, be sure to connect three cables each for **L** and **N**. There is a risk of touching the unused terminals through the gap of the **OUTPUT** terminal cover.

When the product is shipped from the factory, an **OUTPUT** terminal cover is attached to keep the **OUTPUT** terminals from becoming exposed. If you are not using the **OUTPUT** terminal block, attach the terminal cover so that the terminals are not exposed.

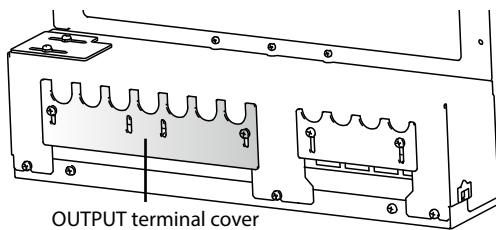

OUTPUT terminal cover

- 1** Turn the **POWER** switch off (O).
- 2** Turn off the switchboard's circuit breaker.
- 3** Unfasten the three **M4** screws from the terminal block cover, and remove the cover.

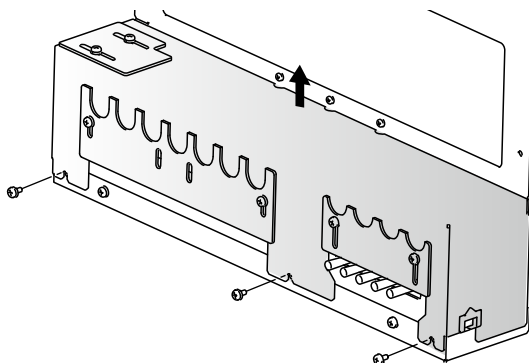

Example of PCR36000WE2 (three-phase
400 V input)

4 Securely connect the load cables to the OUTPUT terminal block.

If the load has a ground (GND) terminal, be sure to connect it to the ⏏ (ground) terminal of the product's OUTPUT terminal block. Be sure to use a wire whose diameter is greater than or equal to the diameter of the wires used to connect the load. For single-phase output, if you are using a bus bar or the like to make the connection, contact your Kikusui agent or distributor.

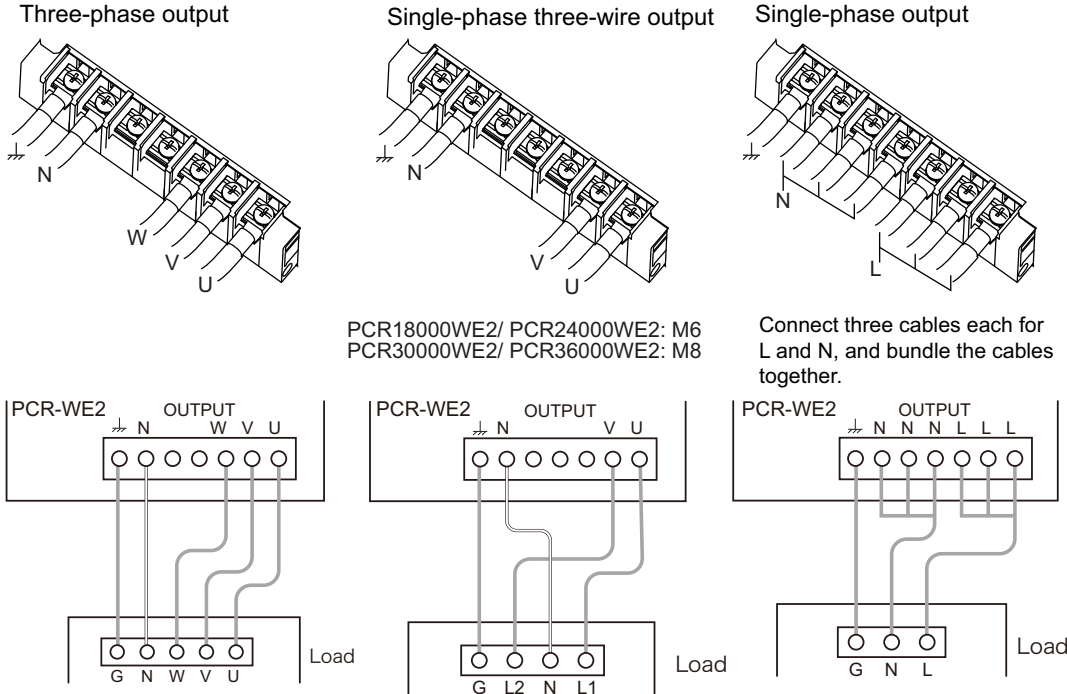

5 To use three-phase output or single-phase three-wire output, remove the OUTPUT (N) terminal cover from the terminal block cover.

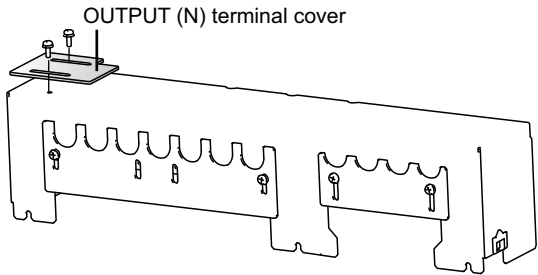

- 6** Remove the two M3 screws, change the orientation of the INPUT terminal cover, and fasten with the screws you just removed.

Tighten the screws just enough so that the OUTPUT terminal cover can still be moved.

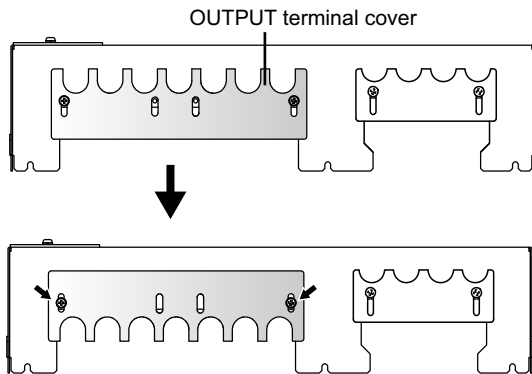

- 7** Fasten the terminal cover you removed in step 3 with the three screws.

- 8** Slide the OUTPUT terminal cover until it touches the wires, and then fasten the screws.

- 9** To use three-phase output or single-phase three-wire output, attach the OUTPUT (N) terminal cover so that the unused terminals are not exposed.

Single-phase three-wire output

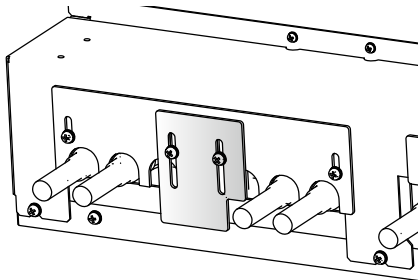

Three-phase output

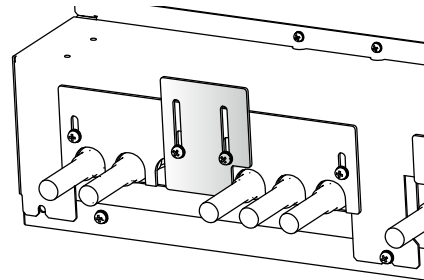

This completes the connections.

Basic Functions

Panel Operation Basics

This section explains the status indicators of the product and the basic operation of the product from the front panel.

Control panel

You can pull out the control panel and tilt it to one of the two available settings.

You cannot detach the control panel from the PCR1000WE/PCR2000WE/PCR3000WE2 because the tilt angle is fixed.

Detaching the control panel

Hold down the two control panel detachment buttons, and pull the control panel toward you.

The control panel will come free of the PCR-WE. The control panel and the PCR-WE are connected by a cable. Do not pull hard on the control panel.

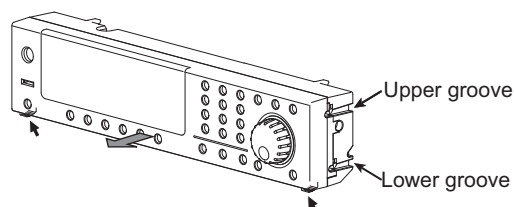

While pressing in the two locations indicated by the arrows, detach the panel by pulling it toward you.

Attaching the control panel

The control panel detachment buttons are not used when you attach the control panel to the PCR-WE. Simply press on the control panel until you hear a click.

- Factory default

Align the upper groove and the lower groove on the control panel with the upper pin and lower pin on the PCR-WE, respectively, and then push the control panel back into the PCR-WE.

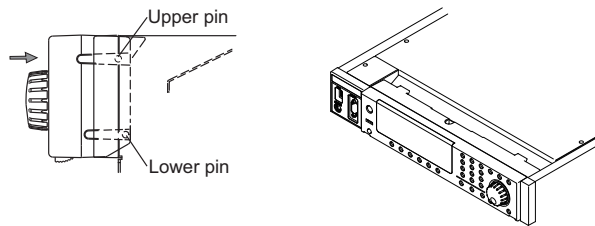

- Tilt slightly

Align the upper groove on the control panel with the upper pin on the PCR-WE, and then push the control panel back into the PCR-WE until the protruding part of the control panel lines up with the slanted surface of the PCR-WE.

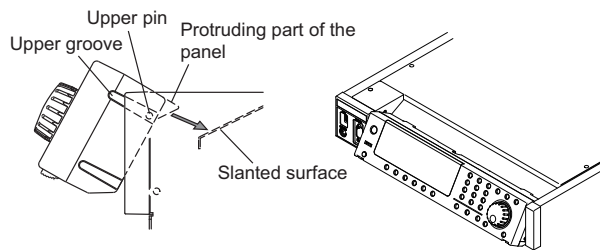

- Make it easily viewable from above.

Align the lower groove on the control panel with the upper pin on the PCR-WE, and then push the control panel back into the PCR-WE until the protruding part of the control panel sits on the slanted surface of the PCR-WE.

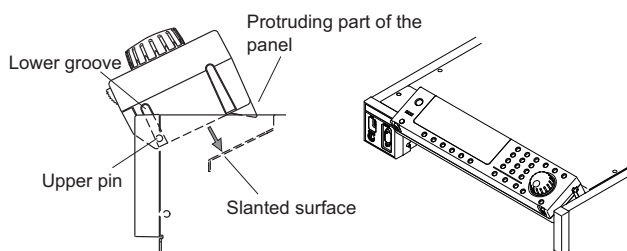

Parts of the screen

The screen consists of the following three parts.

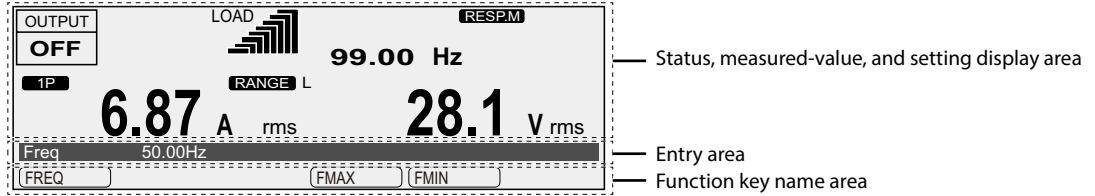

■ Status, measured-value, and setting display area

This area displays the product's present status, measured values, and settings.

■ Entry area

Settings and system settings are entered in this area.

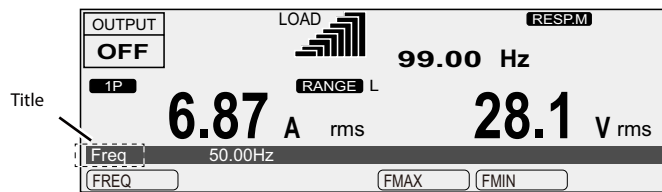





This area displays a title and its corresponding setting.

If an alarm or trouble occurs, the alarm code or the trouble number is displayed here.

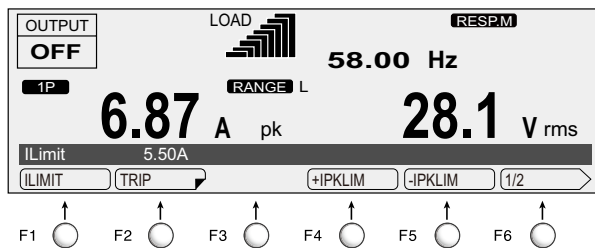
■ Function key name area

The present functions are displayed above the function keys (F1 to F6). The displayed contents vary depending on the selected output voltage mode.



-  This indicates that you can set the displayed item by pressing the function key.
-  This indicates that there is a sub level in the function menu hierarchy.
-  This indicates that there is another page in the function menu. The function key name indicates the following: "present page/total number of pages." The PCR-WE switches between the pages each time that you press this function key.

Explanation of function keys in this manual

The function keys in this manual are explained in a tabular form as shown below.

Item	Title	Description	Conditions that are not allowed
The item name that is displayed in the function key name area (function key)	The title that is displayed in the entry area	An explanation of the function key	When the PCR-WE is being used under the conditions listed here, the contents that are listed for the item cannot be selected.

Home position

The screen that is displayed when you turn the POWER switch on is called the “home position” (the basic screen).



The home position is the top level in the menu hierarchy. All functions are arranged within the menu hierarchy. The home position screen varies depending on the output method. The figure above is an example for the single-phase output mode.

No matter which function you are using, if you repeatedly press ESC, you will move back up through the menu hierarchy towards the home position.

Canceling settings

Press ESC to return to the previous screen.

If you want to cancel settings that you have made, repeatedly press ESC until you return to the home position. If you press ESC at the home position, a buzzer will sound.

Waiting for confirmation

This product has a “confirmation wait” state during which you can confirm the operation results (the ENT indicator blinks). The ENT wait state continues until the ENT key is pressed. Press ENT to apply the settings.



Press ESC to cancel the settings.

Busy status

Busy status refers to the condition in which the product's output cannot be turned on or its settings cannot be changed because of the ongoing hardware or firmware process. When the product is in the busy status, "Busy..." is displayed.



Returning the product to the factory default settings

There are two methods to initialize this product. One method returns all the settings to their factory defaults, and the other returns a portion of the settings to their factory defaults. For details, see "Factory Default Settings and Reset Settings" (p.190).

Switching from remote mode to local mode

When the product is in remote mode, "RMT" is displayed in the upper right of the screen. To switch the product to local mode from the panel, press LOCAL (SHIFT+2).

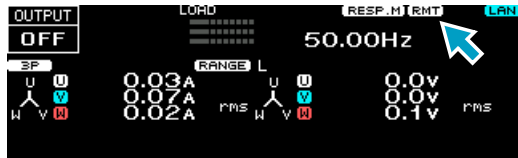

Displaying single-phase three-wire output and three-phase output (PCR-WE2 only)

Changing the phase display

You can display all phases or only a single phase.

Single-phase display (example of U-phase display)



All-phase

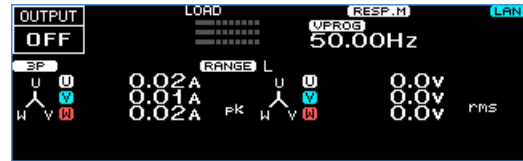

Press PHASE (SHIFT+F) to set the phase to display.





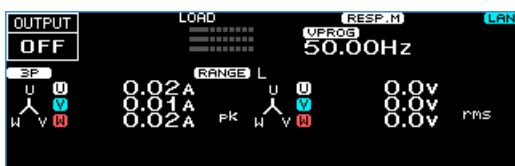

Parameter	Title	Description
U (F1)	DispPhase	The U phase is displayed. The line voltage is the voltage between U and V.
V (F2)		The V phase is displayed. The line voltage is the voltage between V and W.
W (F3) ^{*1}		The W phase is displayed. The line voltage is the voltage between W and U.
ALL (F4)		All phases are displayed.

*1. Displayed only for three-phase output

Switching between phase voltage and line voltage

Press V-MEAS (SHIFT+V) > LINE(F4) to select whether to display the phase voltage or line voltage.



Parameter	Title	Description
ON(F2)	V-Line	Displays the line voltage
OFF(F3)		Displays the phase voltage. This is the factory default setting.
V-LINE		OFF (Phase voltage display) ON (Line voltage display)
When a single phase is displayed	 U-phase example	 U-V example
When all phases are displayed (single-phase three-wire output)		
When all phases are displayed (three-phase output)		

NOTE Phase voltage and line voltage

In three-phase AC output, when the phase difference between U, V, and W is 120° and the output voltages are equal,
 Line voltage = $\sqrt{3} \times$ phase-voltage

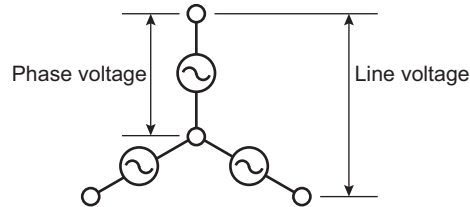

Specifying unbalance

If you set each phase to different voltages or set the phase difference to unbalanced, the unbalance icon appears.

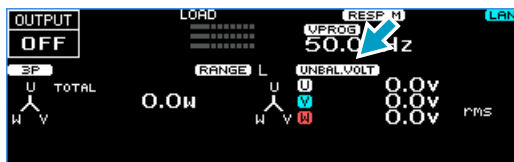

Output	Voltage of each phase	Phase difference		Display
		U-V	U-W	
Single-phase three-wire	Different	180°	—	UNBAL. VOLT
Three-phase	Same	Other than 120°	Other than 240°	UNBAL.PHAS*1
	Different	120°	240°	UNBAL.VOLT
	Different	Other than 120°	Other than 240°	UNBAL.PHAS, VOLT*1

*1. If either the “U and V” or “U and W” condition applies, the configuration is considered unbalanced.

Specifying values

To specify values, use the numeric keypad or the rotary knob. When the cursor is displayed in the entry area, you can use the numeric keypad or the rotary knob to specify a value.

Numeric keypad operations

If you use the numeric keypad to enter a value, the value that you entered is displayed in the entry area.

To enter a negative value, first press +/- (SHIFT+0).

Press CLR to clear any settings that you have made before pressing ENT.

Press ENT to apply the values that you have specified. If you press ESC before you press ENT, any settings that you have made will be canceled.



Rotary knob operations

Turn the rotary knob to the right to increase the displayed value. Turn the rotary knob to the left to decrease the displayed value. You do not need to press ENT.

CAUTION A voltage or frequency that is greater than is necessary may cause damage to the load or put the operator in danger. Be sure to set the voltage and frequency limits. For details, see "Setting Limits" (p.67).

External keyboard operations

If you connect a keyboard to the USB port on the front panel, you can enter numbers from the keyboard. You can change the value with the ↑ and ↓ keys, cancel numeric keypad input with Backspace, cancel input with Escape, and apply the value with Enter.

Only use the number keys, ↑ and ↓ keys, Backspace, Escape, and Enter.

Digit function

The digit function enables you to use the rotary knob to change only the specified digit and the higher digits when you are setting the voltage or frequency. This function is useful when you are changing the voltage or frequency in steps.



1 Check that the PCR-WE is in a state in which you can specify a value.

The digit function is valid when the cursor is displayed at a value in the entry area.

2 Press DIGIT (SHIFT+.) until the cursor is displayed at the digit that you want to change.

Only the digit that is indicated by the cursor and the higher digits will be changed (except when the value that you are changing reaches the maximum or minimum settable value).

Each time that you press DIGIT (SHIFT+.), the cursor moves to the left (to the tens digit for voltage). If the cursor is at the highest digit and you press DIGIT (SHIFT+.), the cursor will move to the lowest digit.

If you press ESC, the cursor will move to the lowest digit.

3 Use the rotary knob to set the value.

The digit function is not valid if you are using the numeric keypad to enter the value.

Adjusting the screen brightness

You can set the screen brightness to one of three levels (1 to 3). The larger the number, the brighter the screen.

Press CONFIG (SHIFT+OPR MODE) > DISPLAY (F4) to set the screen brightness.

Parameter	Title	Description
INTEN	Inten	Sets the screen brightness

Viewing the firmware version

To view the product's firmware version, press CONFIG (SHIFT+OPR MODE) > MODEL ID (F5). When parallel operation is in use, the model information of the slave unit is also displayed. When an option board is installed, its information is also displayed.

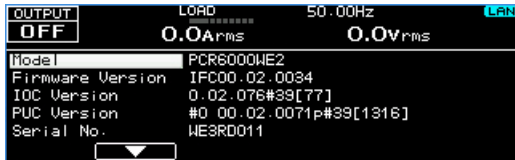

Parameter	Description
Model	Model name
Firmware Version	Firmware version
Serial No.	Serial number
Option I/F	Option board name
IFC Version	IFC version
IOC Version	IOC version
PUC Version	PUC version, displayed for each power module

Locking panel operations (key lock)

You can lock the PCR-WE's keys to prevent mistaken operations such as changes to the settings and overwriting of memory entries.



- Key lock
Press KEYLOCK (SHIFT+5) to lock the panel keys except the OUTPUT key and the KEYLOCK (SHIFT+F5) key. When the keys are locked, "KEYLOCK" is displayed on the screen.
- Release key lock
While the keys are locked, press KEYLOCK (SHIFT+5) again to unlock the keys.

Selecting the Output Method

Select the output method (single-phase output, single-phase three-wire output, or three-phase output). (PCR-WE2 only)

Current will not flow through unused terminals.

The OUTPUT terminal connection needs to be changed according to the output method setting. When making a change, be sure to turn off the POWER switch.

If the output state is set so that it is on when the POWER switch is turned on ([p.26](#)), the output turns on automatically when the output method is changed.

1 Press **OPR MODE > WIRING (F5)**.

2 Select the output method you want to use.

Parameter	Title	Description	Conditions that are not allowed
1P (F1)	Wiring	Single-phase output	Output on
1P3W (F2)		Single-phase three-wire output	
3P (F3)		Three-phase output. (This is the factory default setting.)	

3 Press **ENT**.

The output cannot be turned on for a few seconds after the output method is changed (busy status).

This completes the setting.

Setting the Output Voltage

Set the output voltage range and output voltage.

Setting the output voltage range

This product has the following output voltage ranges: L and H. (The factory default setting is L.)

Output voltage range setup procedure

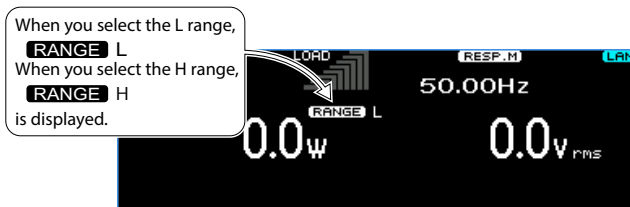

- 1** Press RANGE (SHIFT+8).
- 2** Select the output method you want to use.

Parameter	Title	Description	Conditions that are not allowed
L (F2)	VRange	The L range is selected.	AC voltage setting ≥ 157.5 V DC voltage setting ≤ -222.5 V or DC voltage setting ≥ 222.5 V Peak value of the AC+DC waveform outside the -222.8 V to 222.8 V range Output on
H (F3)		The H range is selected.	Output on

	Output voltage setting range	
	AC voltage	DC voltage
L range	0 V to 157.5 V	-222.5 V to +222.5 V
H range	0 V to 315 V	-445.0 V to +445.0 V

- 3** Press ENT.
The output cannot be turned on for approximately 0.6 s after the range is switched (busy status). This completes the switching of the range.

About setting the output voltage

You can set the output voltage regardless of whether the output is on or off. The measured value is always displayed.

Set the voltage limit to prevent the product from generating a voltage that is greater than is necessary (p.67).

Be sure to set the output method (single-phase output, single-phase three-wire output, or three-phase output) before you set the voltage (p.47).

The PCR-WE output impedance is extremely low, so depending on the load, a current may flow even if the voltage is set to 0.0 V. Be sure to turn the output off or turn the POWER switch off when you do not want any current to flow and before you connect a load.

- AC output.

Specify the AC voltage that you want to generate.

Set the DC voltage to 0 V.

- DC output

Specify the DC voltage that you want to generate.

Set the AC voltage to 0 V, and the output-on phase and output-off phase to free (p.59).

- AC+DC output

Voltage waveforms in which AC has been overlaid on top of DC and voltage waveforms in which DC has been overlaid on top of AC are generated.

Specify the AC and DC voltages that you want to generate.

The voltage can be set only when the AC and DC voltage settings are within the voltage limit values, and the peak value of the AC+DC waveform is between -445.5 V and 445.5 V for the H range or -222.8 V and 222.8 V for the L range.

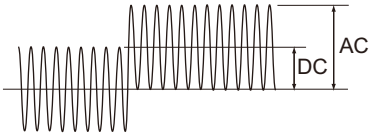
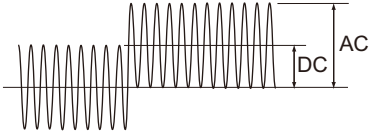
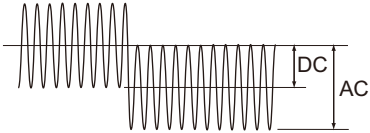
Output method	Example of output voltage
Single-phase output Each phase of three-phase output	
Single-phase three-wire output	<p>U phase</p>  <p>V phase *1</p> 

*1. The V phase is automatically set to the same amplitude as the U phase but with reverse polarity.

■ **When the output is on**

If the output is on, the measured value and the setting are displayed. You can adjust the output voltage while viewing the output voltage setting and the measured value.

If you are using the rotary knob to set the value, you may increase or decrease the value too much because the display response is slow. Until you have an intuitive understanding of the display response speed, change the output voltage while viewing the voltage setting or make small changes to the output voltage.

■ **Conditions that are not allowed**

You cannot set the voltage if the product is in any of the following conditions.

The voltage setting is outside the range defined by the AC voltage limits or DC voltage limits (including the 0 V setting).

The peak value of the AC+DC waveform is outside the -445.5 V to 445.5 V range for H range and -222.8 V to 222.8 V range for L range.

The external analog signal source is EXT.

The voltage is being changed with an external analog signal.

The compensation function is set to regulation adjustment (DC voltage only).

■ **Output voltage setting range**

Setting range for single-phase output and phase voltage setting range for single-phase three-wire output and three-phase output

Voltage setting range		
L range	AC voltage	0 V to 157.5 V
	DC voltage	-222.5 V to +222.5 V
H range	AC voltage	0 V to 315.0 V
	DC voltage	-445.0 V to +445.0 V

Line voltage setting range for single-phase three-wire output and three-phase output

Line voltage cannot be set when the phase difference is unbalanced.

The line voltage for single-phase three-wire output is twice the phase voltage.

The line voltage for three-phase output is $\sqrt{3}$ times the phase voltage.

The line voltage is computed from the AC voltage of the U phase and generated (rounded to two decimal places).

Setting range			
		Single-phase three-wire output	3P output
L range	AC voltage	0 V to 315.0 V	0 V to 272.7 V
	DC voltage	-445.0 V to +445.0 V	—
H range	AC voltage	0 V to 630.0 V	0 V to 545.5 V
	DC voltage	-890.0 V to +890.0 V	—

Output voltage setup procedure for single-phase output

Press V > ACVOLT (F1) to set the AC voltage.

Press V > DCVOLT (F2) to set the DC voltage.

The DC voltage can be set only when the peak value of the AC+DC waveform is between -445.5 V and 445.5 V for the H range or -222.8 V and 222.8 V for the L range.

Parameter	Title	Description	Conditions that are not allowed
ACVOLT (F1)	AC Volt	Sets the AC voltage	—
DCVOLT (F2)	DC Volt	Sets the DC voltage	The peak value of the AC+DC waveform is outside the -445.5 V to 445.5 V range for H range and -222.8 V to 222.8 V range for L range.

Output voltage setup procedure for single-phase three-wire output

Specifying the AC voltage with phase voltages

To set all the phases at the same time, press V > AC PH VOLT (F1). The line voltage is set to twice the specified value.

To set the U phase, press V > 1/3 (F6) > U ACVOLT (F1). To set the V phase, press V > 1/3 (F6) > V ACVOLT (F2). With an unbalanced configuration, the unbalance icon is displayed.

Parameter	Title	Description
AC PH VOLT (F1)	AC Phase Volt	Sets the AC voltage of all the phases
U ACVOLT(F1)	U AC Phase Volt	Sets the AC voltage of the U phase
V ACVOLT(F2)	V AC Phase Volt	Sets the AC voltage of the V phase

Specifying the AC voltage with line voltage

Press V > AC LIN VOLT (F2) to set the line voltage.

Parameter	Title	Description
AC LIN VOLT (F2)	AC Line to line Volt	Sets the line voltage

Specifying the DC voltage with phase voltage

Press V > DC PH VOLT (F3) to set the DC voltage to assign to the U phase. The V phase is automatically set to the same amplitude as the U phase but with reverse polarity. The line voltage is set to twice the specified value.

Parameter	Title	Description
DC PH VOLT(F3)	DC Phase Volt	Sets the DC voltage

Specifying the DC voltage with line voltage

Press V > DC LIN VOLT (F4) to set the line voltage.

Parameter	Title	Description
DC LIN VOLT (F4)	DC Line to line Volt	Sets the line voltage

Output voltage setup procedure for three-phase output

Specifying the AC voltage with phase voltages

To set all the phases at the same time, press V > AC PH VOLT (F1).

To set the U phase, press V > 1/4 (F6) > U ACVOLT (F1).

To set the V phase, press V > 1/4 (F6) > U ACVOLT (F2).

To set the W phase, press V > 1/4 (F6) > W ACVOLT (F3).

With an unbalanced configuration, the unbalance icon is displayed.

Parameter	Title	Description
AC PH VOLT (F1)	AC Phase Volt	Sets the AC voltage of all the phases
U ACVOLT(F1)	U AC Phase Volt	Sets the AC voltage of the U phase
V ACVOLT(F2)	V AC Phase Volt	Sets the AC voltage of the V phase
W ACVOLT(F3)	W AC Phase Volt	Sets the AC voltage of the W phase

■ Setting the phase difference

You can set the phase differences between U and V and between U and W.

To set the phase difference between U and V, press V > 1/4 (F6) > UV PHASE (F4). To set the phase difference between U and W, press V > 1/4 (F6) > UW PHASE (F5).

If the phase difference between U and V is set to a value other than 120° or the phase angle between U and W is set to a value other than 240°, the unbalance icon (UNBAL.PHAS) is displayed.

-360 deg = 0 deg = 360 deg.

Parameter	Title	Description
UV PHASE (F4)	UV Phase	Sets the phase difference between U and V (-360 deg to 360 deg)
UW PHASE (F5)	UW Phase	Sets the phase difference between U and W (-360 deg to 360 deg)

Normally, the U phase is the product's reference phase. If the sequence ends with a U phase offset, the U PH OFFS icon will appear.

If the icon is displayed, press SEQ (SHIFT+SIM) > 1/2 (F6) > U PHASE (F1) > OFFS INIT (F1) to clear the offset.

Specifying the AC voltage with line voltage

You can set the line voltage when the phase difference between U and V is 120° and the phase difference between U and W is 240°. Press V > AC LIN VOLT (F2) to set the voltage.

Parameter	Title	Description
AC LIN VOLT (F2)	AC Line to line Volt	Sets the line voltage

Setting the DC voltage

To set all the phases at the same time, press V > DC PH VOLT (F3).

To set the U phase, press V > 1/4 (F6) > 2/4 (F6) > U DCVOLT (F1). To set the V phase, press V > 1/4 (F6) > 2/4 (F6) > V DCVOLT (F2). To set the W phase, press V > 1/4 (F6) > 2/4 (F6) > W DCVOLT (F3). With an unbalanced configuration, the unbalance icon is displayed.

Parameter	Title	Description
DC PH VOLT (F3)	DC Phase Volt	Sets the DC voltage of all the phases
U DCVOLT(F1)	U DC Phase Volt	Sets the DC voltage of the U phase
V DCVOLT(F2)	V DC Phase Volt	Sets the DC voltage of the V phase
W DCVOLT(F3)	W DC Phase Volt	Sets the DC voltage of the W phase

Setting the voltage offset

You can set the output voltage offset. This is useful for finely adjusting 0 V.

For single-phase three-wire output and three-phase output, set a voltage offset for each phase.

Press CONFIG (SHIFT+OPR MODE) > 1/3 (F6) > ADJUST (F2) > VOLT ADJ (F2) to set the voltage offset.

Parameter	Title	Description	
O.TERM(F1)	O.TERM Voltage Adjust	Voltage offset when the sensing function is not in use	Single-phase output
U(F1)*1	O.TERM U Voltage Adjust		U phase
V(F2)*1	O.TERM V Voltage Adjust		V phase
W(F3)*2	O.TERM W Voltage Adjust		W phase
S.TERM(F2)	S.TERM Voltage Adjust	Voltage offset when the sensing function is in use	Single-phase output
U(F1)*1	S.TERM U Voltage Adjust		U phase
V(F2)*1	S.TERM V Voltage Adjust		V phase
W(F3)*2	S.TERM W Voltage Adjust		W phase

*1. Only for single-phase three-wire output and three-phase output

*2. Only for three-phase output

Setting the Frequency

You can set the frequency regardless of whether the output is on or off.

Set the frequency limit to prevent the product from generating a frequency that is greater than is necessary (p.68).

On the 500 Hz limit model, the upper limit is limited to 500 Hz only for three-phase output.

■ Frequency setup procedure

Press F > FREQ (F1) to set the frequency.

Parameter	Title	Description	Conditions that are not allowed
FREQ	Freq	Sets the frequency (1.00 Hz to 5000 Hz)	Synch function is on. The external analog signal source is EXT. The frequency is being changed with an external analog signal. The frequency is outside the range defined by the frequency limits.

Turning the Output On/Off



WARNING

Risk of electric shock.

Do not touch the OUTPUT terminal block or the sensing terminals.

If a capacitor, battery, or similar item is connected as the load, a voltage remains until the load's energy is discharged, even when the output is off. Do not touch parts that are connected to the OUTPUT terminal block or sensing terminals.



CAUTION

Depending on the current and load inductance, an undershoot or overshoot ranging from several hundred millivolts to several volts may be produced when the output is turned on or off.

Each time that you press OUTPUT, the output toggles between on and off.

- Output on

"OUTPUT ON" is shown on the display.

The output is produced with the specified voltage and frequency.



- Output off

"OUTPUT OFF" is shown on the display.

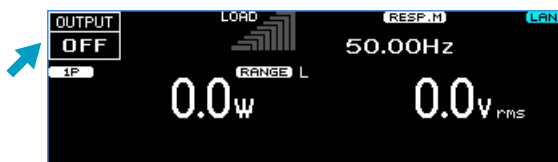

Impedance when the output is off

The internal circuits and the output of the PCR-WE are not separated by a mechanical switch or relay. The PCR-WE turns the output off by electrically increasing the output impedance. This enables you to turn the output on and off without chattering. When the output is off, the output is set to high impedance, and the output voltage is nearly 0 V.

Even when the output is on, the following impedances are present, so if the load is a battery or a similar device, a slight current may flow into the PCR-WE, and the load may be discharged.

	Single-phase output		1P3W output, 3P output	
	L range	H range	L range	H range
PCR1000WE	Approx. 160 k Ω	Approx. 643 k Ω	—	—
PCR2000WE	Approx. 81 k Ω	Approx. 346 k Ω	—	—
PCR3000WE2	Approx. 55 k Ω	Approx. 237 k Ω	Approx. 160 k Ω	Approx. 643 k Ω
PCR6000WE2	Approx. 55 k Ω	Approx. 237 k Ω	Approx. 160 k Ω	Approx. 643 k Ω
PCR12000WE2	Approx. 27 k Ω	Approx. 122 k Ω	Approx. 81 k Ω	Approx. 346 k Ω
PCR18000WE2	Approx. 18 k Ω	Approx. 82 k Ω	Approx. 55 k Ω	Approx. 237 k Ω
PCR24000WE2	Approx. 14 k Ω	Approx. 62 k Ω	Approx. 41 k Ω	Approx. 180 k Ω
PCR30000WE2	Approx. 11 k Ω	Approx. 49 k Ω	Approx. 33 k Ω	Approx. 148 k Ω
PCR36000WE2	Approx. 9 k Ω	Approx. 41 k Ω	Approx. 27 k Ω	Approx. 122 k Ω

Voltage surge suppression when the output is turned off

You can set the voltage surge suppression that is activated when the output is turned off.

When the output is off, the output of this product is at high impedance.

If voltage surge suppression is set to ON (factory default setting), immediately after the output is turned off, the output voltage is set to 0 V (low output impedance), and then the impedance is changed to high. To prevent large overshooting and undershooting by the load immediately after the output is turned off, we recommend that you use the PCR-WE with the voltage surge suppression set to on.

If the voltage surge suppression is on, an unexpected current may flow through the product immediately after the output is turned off depending on the connected load (power conditioner, regenerative inverter, battery, etc.). This may affect the test. Turn voltage surge suppression off for the above loads.

If the voltage surge suppression function is off, "OUTPUT*" is displayed.



Press CONFIG (SHIFT+OPR MODE) > 1/3 (F6) > SURGE S (F2) to set the voltage surge suppression.

Parameter	Title	Description
ON (F2)	Surge suppression	Voltage surge suppression on The output is turned off after the output voltage is set to 0 V.
OFF (F3)		Voltage surge suppression off The output is turned off with the output left at high impedance.

Output on/off phase control

You can set the output-on phase and output-off phase separately for AC output. For single-phase three-wire output and three-phase output, set the U-phase.

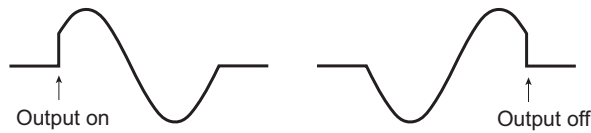

■ Output-on phase setup procedure

When you are controlling the output-on phase, set the phase angle as well. If the output-on phase is set, "ON PHASE" is displayed.



Press ON PHASE (SHIFT+7) to set the output-on phase.

Parameter	Title	Description
FIXED (F2)	ON Phase	The output-on phase is controlled. Sets the output-on phase angle (0 deg to 360 deg) 0 deg = 360 deg
FREE (F3)		The output-on phase is not controlled.

■ Output-off phase setup procedure

When you are controlling the output-off phase, set the phase angle as well. If the output-off phase is set, "OFF PHASE" is displayed.



Press OFF PHASE (SHIFT+4) to set the output-off phase.

Parameter	Title	Description
FIXED (F2)	OFF Phase	The output-off phase is controlled. Sets the output-off phase angle (0 deg to 360 deg) 0 deg = 360 deg
FREE (F3)		The output-off phase is not controlled.

AC coupling

This product uses an internal DC amplifier to achieve the functions of DC output and power line abnormality simulation.

The AC signal (AC REF) generated internally is input directly into the DC amplifier. The product can reliably amplify the power of the AC REF signal and output the signal, but the DC voltage component included in the AC REF signal is also amplified and output (a DC offset voltage is superimposed on the AC output voltage).

This is not a problem for general loads, but unexpected excitation (magnetization) current may flow with transformers or slide transformers with small saturation magnetic flux density.

If AC coupling is enabled, AC coupling is used between the AC REF signal and DC amplifier. The DC offset voltage is reduced to several tens of millivolts or less, suppressing the magnetization phenomenon in transformers or slide transformers. Because the amplifier is AC coupled, the output voltage is reduced slightly in the low frequency range. The frequency response is within $\pm 1\%$ in the 40 Hz to 999.9 Hz range with 200 Hz as the reference. Note that there are limitations to the performance when performing power line abnormality simulation or producing special waveforms.

When AC coupling is enabled, "AC.C" is displayed.



Press OPR MODE > ACCOUP (F1) to set AC coupling.

Parameter	Title	Description
Enable(F2)	AC Coupling	Enables AC coupling
Disable(F3)		Disables AC coupling Factory default

Measurement Display

You can monitor the present output value. When the output is off, this is nearly 0.

You can change the phase to display for single-phase three-wire output and three-phase output. (p.42)

Displaying the voltage

The measured voltage is displayed in the status, measured-value, and setting display area.

You can select whether to display the rms, peak, or average voltage.

Press V-MEAS (SHIFT+V) to select the item that you want to display.

For single-phase three-wire output and three-phase output, you can select to display the phase voltage or line voltage (p.42).

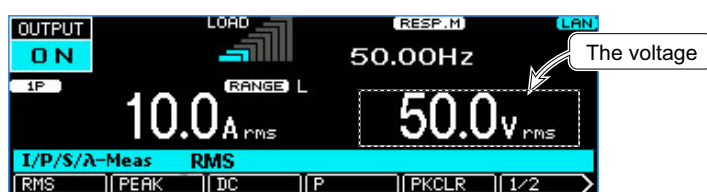

Parameter	Title	Unit	Description
RMS(F1)	V-Meas	V rms	Displays the rms voltage
PEAK(F2)		V pk	Displays the peak voltage
DC(F3)		V dc	Displays the average voltage
LINE*1 (F4)	ON(F2)	V-Line	Displays the line voltage
	OFF(F3)		Displays the phase voltage

*1. Only for single-phase three-wire output and three-phase output

Averaging voltage measurements

You can average the rms-voltage and average-voltage measurements and display the result.

Press V-MEAS (SHIFT+V) > 1/2 (F6) > AVERAGE (F4) to select whether to average the voltages.

Parameter	Title	Description
AVERAGE(F4)	Average Count	Values will be averaged. Average count (moving average): 1 to 32

Holding the peak voltage

If the measurement display is set to peak voltage, the peak voltage can be held.

Press V-MEAS (SHIFT+V) > 1/2 (F6) > VPK TIM (F5) to set the hold time.

Parameter	Title	Description	Factory default
VPK TIM(F5)	VPk Time	Sets the hold time (0 s to 10 s or ∞). If you use the numeric key pad to specify a value that is greater than or equal to 11, infinity (∞) will be specified.	0 s

■ Clearing the peak voltage

Press V-MEAS (SHIFT+V) > PKCLR (F5) to clear the peak voltage.

Parameter	Description
PKCLR(F5)	Clearing the peak voltage

Load level meter

The load level meter displays the ratio of the output current (which is detected as the current flowing through the load) to the rated current on a bar graph. This can be used to determine the approximate output current supply capability. The full scale of the load level meter is 1.1 times the rated current or the current limit, whichever is less.

For single-phase three-wire output, the load level meter displays the U phase at the top and then the V phase.

For three-phase output, the load level meter displays the U phase at the top followed by the V phase and W phase.

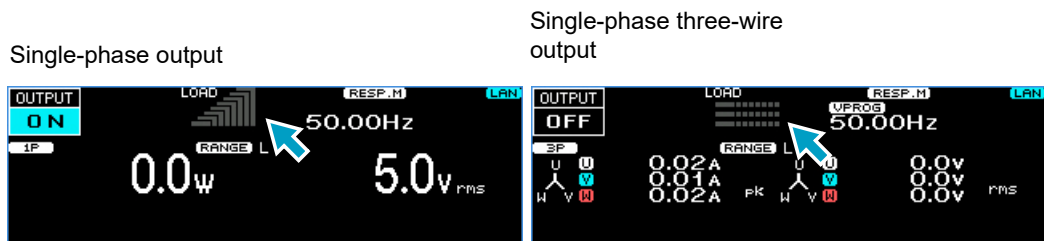

The full scale bar (the right-most bar that lights red) of the load level meter lights on the verge of an overload.

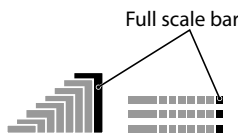

When the PCR-WE is on the verge of an overload, the internal temperature increases. Even if the load is reduced, the full scale bar may continue to light dimly in red. When cooling is complete, the full scale bar turns off.

If overload conditions occur repeatedly while the full scale bar is lit, an alarm (ALM-06: OVERLOAD) may be generated.

■ Rated current and load level meter display

The output current varies depending on the load. The rated current is automatically derated (reduced) depending on the output conditions (output voltage and frequency).

For details on determining the rated current, see “Output and Load” (p.226).

The full scale of the load level meter is set to 1.1 times the calculated rated current or the current limit, whichever is less.

Displaying the current, power, and power factor

You can select which value to display normally in the status, measured-value, and setting display area from rms current, peak current, average current, power, apparent power, and power factor.

To switch the display, press I/P/S/λ-MEAS (SHIFT+I) to select the item that you want to display.

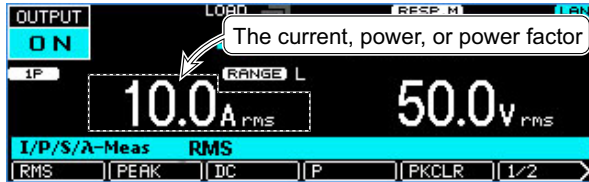

Parameter	Title	Unit	Description
RMS(F1)	I/P/S/λ-Meas	A rms	Displays the rms current
PEAK(F2)		A pk	Displays the peak current
DC(F3)		A dc	Displays the average current
P(F4)		W/ kW	Displays the power
1/3(F6) > S(F1)		VA/ kVA	Displays the apparent power
1/3(F6) > λ(F2)		λ	Displays the power factor
1/3(F6) > TOTAL P*1 (F3)		W/ kW	Displays the total power
1/3(F6) > TOTAL S*1 (F4)		VA/ kVA	Displays the total apparent power
1/3(F6) > TOTAL λ*1 (F5)		λ	Displays the total power factor

*1. Only for single-phase three-wire output and three-phase output

Averaging current and power measurements

You can display the averaged measurements of rms currents, average currents, power values, apparent power values, and power factors.

Press I/P/S/λ-MEAS (SHIFT+I) > 1/3 (F6) > 2/3 (F6) > AVERAGE (F4) to set whether to average currents, power values, and power factors.

Parameter	Title	Description
AVERAGE(F4)	Average Count	Values will be averaged. Average count (moving average): 1 to 32

Holding the peak current

The peak current is displayed as an absolute value of the maximum instantaneous current measured. Even if a negative DC voltage is being generated, the peak current is displayed as a positive value.

If the measurement display is set to peak current, the peak current can be held.

Press I/P/S/Λ-MEAS (SHIFT+I) > 1/3 (F6) > 2/3 (F6) > IPK TIM (F5) to set the hold time.

Parameter	Title	Description
IPK TIM(F5)	IPk Time	Sets the hold time (0 s to 10 s or ∞). If you use the numeric key pad to specify a value that is greater than or equal to 11, infinity (∞) will be specified.

■ Clearing the peak current

Press I/P/S/Λ-MEAS (SHIFT+I) > PKCLR (F5) to clear the peak current.

Parameter	Description
PKCLR(F5)	Clearing the peak current

Limit Function and Protection Function

This product has the following limit functions and protection functions.

- Limit function

Limits can be placed on the PCR-WE output voltage setting and frequency setting. They prevent damage to the load caused by mistaken operations and limit the current that flows through the load.

- Protection function

The protection function applies limits when there is a danger of damaging the product's internal circuitry or to protect the load.

When a protection function is activated, an alarm (ALM-xx) or a trouble indication (TRBL-xx) is generated, and the output is turned off.

Parameter	Function	Description	Output off
Upper voltage limit Lower voltage limit	Limit	You will not be able to specify voltages that are outside of the limit range.	No
Output overvoltage protection (OVP)	Protection	If the measured voltage exceeds the OVP value, an alarm occurs, and the output turns off.	Yes
Output undervoltage protection (UVP)	Protection	If the measured voltage falls below the UVP value, an alarm occurs, and the output turns off.	Yes
Upper frequency limit Lower frequency limit	Limit	You will not be able to specify frequencies that are outside of the limit range.	No
Current Limit	Limit	If the limit value (upper limit) is exceeded, the output turns off, or the output voltage is controlled so that the limit value is not exceeded. You cannot set the lower limit. You can set how the product behaves when the limit is exceeded (whether to turn off the output). If you select to turn off the output, you can set the amount of time that must elapse before the output is turned off when the current limit is exceeded. If you select to control the output voltage, the following functions will not be available. <ul style="list-style-type: none"> • Turn soft start on (set the rise time). • Turn soft stop off (set the fall time). • Execute power line abnormality simulations. • Run sequences. • Use the compensation function's soft sensing and regulation adjustment. 	Selectable
Peak current limit	Limit	This function instantly limits the peak output current. You can set positive and negative limits.	No
Input voltage drop protection	Protection	If the input voltage falls below the rating, a trouble indication occurs, and the output turns off.	Yes
Overload protection	Protection	If the output current exceeds the rated current or current limit, an alarm occurs, and the output turns off.	Yes
Overheat protection (OHP)	Protection	If the internal temperature increases abnormally, an alarm occurs, and the output turns off.	Yes

Setting Limits

Limits can be placed on the PCR-WE output voltage setting and frequency setting. They prevent damage to the load caused by mistaken operations and limit the current that flows through the load. You can set limits in advance according to the load conditions.

You can set limits regardless of whether the output is on or off.

Upper and lower voltage limits

Limits can be placed on the PCR-WE output setting. They prevent damage to the load caused by mistaken operations. You can set limits in advance according to the load conditions.

After you set the voltage limits, you will no longer be able to specify voltage values that are outside of the range that you have set.

Set the limits so that the lower limit is less than or equal to the upper limit.

There are AC limits and DC limits. Check the title in the entry area, and then set the value.

Limits apply to all phases for single-phase three-wire output and three-phase output. Set the voltage using phase voltage.

- Single-phase output

To set the upper voltage limit, press V > VMAX (F4).

To set the lower voltage limit, press V > VMIN (F5).

- Single-phase three-wire output

To set the upper voltage limit, press V > 1/3 (F6) > 2/3 (F6) > VMAX (F4).

To set the lower voltage limit, press V > 1/3 (F6) > 2/3 (F6) > VMIN (F5).

- Three-phase output

To set the upper voltage limit, press V > 1/4 (F6) > 2/4 (F6) > 3/4 (F6) > VMAX (F4).

To set the lower voltage limit, press V > 1/4 (F6) > 2/4 (F6) > 3/4 (F6) > VMIN (F5).

Parameter	Title	Description
ACV MAX (F1)	ACVoltMax AC PhaseVoltMax*1	Sets the upper AC voltage limit (0.0 V to 315.0 V)
ACV MIN(F1)	ACVoltMin AC PhaseVoltMin*1	Sets the lower AC voltage limit (0.0 V to 315.0 V)
DCV MAX(F2)	DCVoltMax DC PhaseVoltMax*1	Sets the upper DC voltage limit (-445.0 V to 445.0 V)
DCV MIN(F2)	DCVoltMin DC PhaseVoltMin*1	Sets the lower DC voltage limit (-445.0 V to 445.0 V)

*1. Display for single-phase three-wire output and three-phase output

Upper and lower frequency limits

Limits can be placed on the product's output frequency. They prevent damage to the load caused by mistaken operations. You can set limits in advance according to the load conditions.

After you set the frequency limits, you will no longer be able to specify frequency values that are outside of the range that you have set.

Set the limits so that the lower limit is less than or equal to the upper limit.

Limits apply to all phases for single-phase three-wire output and three-phase output.

On the 500 Hz limit model, only for three-phase output, the upper frequency limit is set to 500.0 Hz.

You cannot set limits when the sync function is on.

To set the upper frequency limit, press F > FMAX (F4) .

To set the lower frequency limit, press F > FMIN (F5) .

Parameter	Title	Description
FMAX(F4)	FreqMax	Sets the upper frequency limit (1.00 Hz to 5000 Hz)
FMIN(F5)	FreqMin	Sets the lower frequency limit (1.00 Hz to 5000 Hz)

Current limit and peak current limits

Limits can be placed on the current that flows through the load. There is a current limit, a positive peak current limit, and a negative peak current limit. You can set limits according to the load conditions.

The current that can actually be supplied is the maximum peak current ([p.222](#)) or the peak current limit, whichever is less.

- Current Limit

You can set the output current's upper limit. You cannot set the lower limit.

The limit operates on the rms value of the output current.

You can set the action to perform (whether to turn off the output) when the current exceeds the current limit.

You can set the amount of time that must elapse before the output is turned off when the current limit is exceeded.

Current limit setting range: Maximum output current of L range × 0.1 to maximum output current of L range × 1.1

The actual current limit is activated at 1.1 times the rated current or the current limit, whichever is less. The rated current is automatically derated depending on the output conditions (output voltage and frequency) ([p.218](#)). For details on the rated current, see "Output and Load" ([p.226](#)).

The full scale of the load level meter is 1.1 times the maximum rated output current or the current limit, whichever is less.

- Positive peak current limit and negative peak current limit

You can set positive and negative peak current limits.

This function instantly limits the peak output current.

When the current is being limited by the peak current limit, "IPK.LIM" is displayed.



Setting the peak current limits does not change the load level meter's full scale.

Positive peak current limit setting range

Maximum output current of L range x 0.1 to maximum output current of L range x 4.2

Negative peak current limit setting range

Maximum output current of L range x -4.2 to maximum output current of L range x -0.1

To set the current limit, press I > ILIMIT (F1).

To set the positive peak current limit, press I > +IPKLIM (F4).

To set the negative peak current limit, press I > -IPKLIM (F5).

Parameter	Title	Description	
ILIMIT(F1)	I Limit	Sets the current limit	
	U* ¹ (F1)	U ILimit	Sets the current limit of the U phase.
	V* ¹ (F2)	V ILimit	Sets the current limit of the V phase.
	W* ² (F3)	W ILimit	Sets the current limit of the W phase.
	ALL* ¹ (F4)	I Limit	Sets the current limit of the all phases.
+IPKLIM(F4)	+IPKLimit	Sets the positive peak current limit.	
	U* ¹ (F1)	U +IPKLimit	Sets the positive peak current limit of the U phase.
	V* ¹ (F2)	V +IPKLimit	Sets the positive peak current limit of the V phase.
	W* ² (F3)	W +IPKLimit	Sets the positive peak current limit of the W phase.
	ALL* ¹ (F4)	+IPKLimit	Sets the positive peak current limit of all phases.
-IPKLIM(F5)	-IPKLimit	Sets the negative peak current limit.	
	U* ¹ (F1)	U -IPKLimit	Sets the negative peak current limit of the U phase.
	V* ¹ (F2)	V -IPKLimit	Sets the negative peak current limit of the V phase.
	W* ² (F3)	W -IPKLimit	Sets the negative peak current limit of the W phase.
	ALL* ¹ (F4)	-IPKLimit	Sets the negative peak current limit of all phases.

*1. Only for single-phase three-wire output and three-phase output

*2. Only for three-phase output

Action that is performed when the current limit is exceeded

You can set the action to perform (whether the output is turned off) when the current exceeds the current limit. You can set the amount of time that must elapse before the output is turned off when the current limit is exceeded.

The current limit function operates on the rms value of the current.

Press I > TRIP (F2) to select the action to perform when the limit is exceeded.

Parameter	Title	Description
ENABLE(F2)	Trip	If the current exceeds the current limit for more than a given amount of time (the trip time value for AC output (p.71)), "OVERLOAD" lights, the output is turned off, and an alarm (ALM-06: OVERLOAD) is generated.
DISABLE(F3)		Controls the output voltage from exceeding the current limit *1

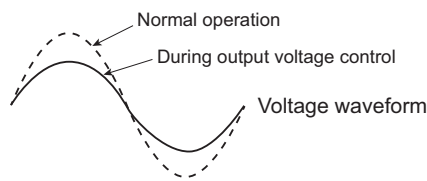

*1. This is calculated as an rms value. The current limit may be exceeded for a few seconds because of the relationship between the measurement processing time and the voltage resolution. The current may oscillate (increase and decrease) while it is being controlled.

- If ENABLE (turn off the output) is selected and the limit is exceeded

The output is turned off, and an alarm (ALM-06: OVERLOAD) is generated. Depending on the current measurement response speed, there may be a delay of approximately 0.1 seconds.

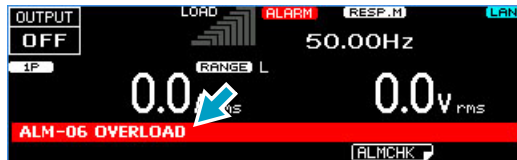

- If DISABLE (do not turn off the output) is selected and the limit is not exceeded

"TRIP DIS." is displayed.

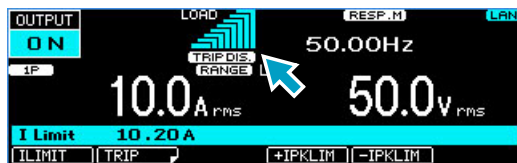

- If DISABLE (do not turn off the output) is selected and the limit is exceeded

"OVERLOAD" is displayed, and the output voltage is controlled from exceeding the limit.

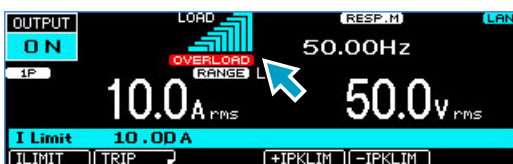

■ If ENABLE (turn off the output) is selected

To clear the alarm, press ALM CLR (SHIFT+CLR).

⚠ CAUTION Risk of malfunction. If an overload occurs, be sure to remove the cause of the problem, and then press OUTPUT.

■ If DISABLE (do not turn off the output) is selected

If you select DISABLE (do not turn off the output), you will not be able to:

- Turn soft start on (set the rise time).
- Turn soft stop on (set the fall time).
- Execute power line abnormality simulations.
- Run sequences.
- Use the compensation function's soft sensing and regulation adjustment.

Setting the amount of time that elapses before the output is turned off when the current limit is exceeded (trip time)

If the action to perform when the current limit is exceeded is set to ENABLE (turn off the output), you can set the amount of time that will elapse after the current limit is exceeded (the amount of time during which the current continuously exceeds the current limit) before the output is turned off. This is useful when you don't want the output to be turned off due to issues such as inrush current causing short-term overloads.

The amount time until the output is turned off may become large due to the state of the load or the timing of the PCR-WE internal current measurement. Depending on the current measurement response speed, there may be a delay of approximately 0.1 seconds.

If the full scale bar of the load level meter continues to be lit, the temperature inside the PCR-WE is high. If an overload occurs repeatedly, the time until the output is turned off may be shortened.

Press I > TRIP (F2) > TRIP TIM (F5) > TRIP TIM (F1) to set the amount of time that will elapse before the output is turned off.

Parameter	Title	Description
TRIP TIM	Trip Time	Sets the amount of time that will elapse (0 s to 10 s) before the output is turned off when the current limit is exceeded

Using Protection Functions

The PCR-WE has the following protection functions.

- Input voltage drop protection
- Overheat protection (OHP)
- Overload protection
- Output undervoltage protection (UVP)
- Output overvoltage protection (OVP)

If a protection function is activated, an alarm sounds, "ALARM" is displayed on the screen, and the output is turned off.

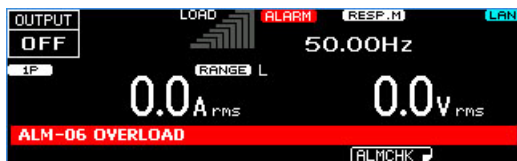

While a protection function is activated, you can only set CONFIG parameters and the key lock.

Clearing alarms

Press ALM CLR (SHIFT+CLR) to clear the alarm, and then fix the problem that caused the alarm.

If an alarm still occurs even after you have corrected all the causes of alarms, the product may be malfunctioning. Stop using it immediately, and contact your Kikusui agent or distributor. Tell the agent or distributor the displayed alarm number.

Input voltage drop protection

If the input voltage drops lower than the rating, the input voltage drop protection function is activated. Adjust the input voltage so that it is within the range in the specifications. If the input power supply wiring is long, use wires that have a large diameter to make the voltage drops smaller.

If the input voltage drops below the rating but recovers within 3 seconds, an alarm (ALM-29: AC INPUT LOW) will be generated.

If the input voltage is continuously below the rating, a trouble indication (TRBL-29: AC INPUT LOW) will be generated. Turn off the POWER switch, and eliminate the cause of the alarm. If the trouble indication is generated again when you turn on the POWER switch, stop using the product immediately, and contact your Kikusui agent or distributor to request repairs.

Overheat protection (OHP)

If the internal temperature rises to an abnormal level, the overheat protection is activated, and an alarm (ALM-02: P.U OHP) is generated. Leave the PCR-WE on, and wait for approximately 10 minutes.

If the alarm has stopped occurring after 10 minutes, the PCR-WE may have been installed incorrectly, or the dust filter may be clogged.

If there are no problems with the installation or the dust filter, stop using the PCR-WE immediately, and contact your Kikusui agent or distributor to request repairs.

Overload protection

If the output current exceeds the rated current or the current limit (and the action to perform when the limit is exceeded is set to turn off the output) (p. 70), the overload protection is activated, and an alarm (ALM-06: OVERLOAD) is generated.

Press ALM CLR (SHIFT+CLR) to clear the alarm, and then fix the problem that caused the alarm. Pressing OUTPUT again turns the output on.

Output undervoltage protection (UVP) and output overvoltage protection (OVP)

UVP and OVP are determined based on rms voltage measurements.

- Output undervoltage protection (UVP)

If the measured voltage drops below the UVP setting and remains there for approximately 1 second, UVP will be activated. An alarm (ALM-07: UVP) will be generated.

You can enable or disable UVP detection.

- Output overvoltage protection (OVP)

If the measured voltage exceeds the OVP setting (rms or peak) and remains there for approximately 1 second, OVP will be activated. An alarm (ALM-00: OVP) will be generated.

■ Setting UVP and OVP

Set UVP using an rms value. Set OVP using an rms value or peak value.

For single-phase three-wire output and three-phase output, set the limits using phase voltages. The values apply to all phases.

To set OVP (rms value), press V > PROTECT (F3) > OVP (F1).

To set OVP (positive peak value), press V > PROTECT (F3) > +PKOVP (F4).

To set OVP (negative peak value), press V > PROTECT (F3) > -PKOVP (F5).

To set UVP, press V > PROTECT (F3) > UVP (F2) > UVP (F5).

If PROTECT(F3) does not appear, hold down F6 until it appears.

Parameter	Title	Description
OVP(F1)	OVP	Sets the OVP value (14.0 V to 489.5 V)
UVP(F2) > UVP(F5)	UVP	Sets the UVP value (0.0 V to 489.5 V)
+PKOVP(F4)	+PKOVP	Sets the positive peak OVP value (14.0 V to 489.5 V)
-PKOVP(F5)	-PKOVP	Sets the negative peak OVP value (-489.5 V to -14.0 V)

■ Setting the UVP operation

You can enable or disable UVP detection.

To set UVP, press V > PROTECT (F3) > UVP (F2).

If PROTECT(F3) does not appear, hold down F6 until it appears.

Parameter	Title	Description
ENABLE(F2)	UVP	Enables UVP.
DISABLE(F3)		Disables UVP. This is the default setting.

Using the Memory

The product's settings can be saved to memory (internal memory or USB memory device).

Items that can be saved

Internal memory

The product has a preset memory and setup memory.

- Preset memory

The following items can be saved to the internal preset memory (A, B, C).

Because you can easily recall saved settings, this feature is useful when you want to switch between three different settings (sudden voltage change or sudden frequency change).

Frequency

AC voltage

DC voltage

Waveform bank number

- Setup memory

Panel settings (p. 192) can be saved to the internal setup memory.

USB memory device

The following items can be saved to a USB memory device.

Panel settings (p. 192)

Power line abnormality simulation settings

Sequence data

Waveform bank data

Using internal preset memory

The frequency, AC voltage, DC voltage, and waveform bank number can be stored to and recalled from the internal preset memory (up to three sets in A, B, and C). This is useful when you are testing drastic changes in voltage or frequency.

For single-phase three-wire output and three-phase output, phase voltages are stored. Line voltages are calculated from phase voltages.

Saving to preset memory

1 Set up the configuration you want to save.

2 Press MEMORY > PRESET (F1) > SAVE (F3).

3 Select the memory (A, B, C) you want to save to.

If you want to save to memory A, press F1. If you want to save to memory B, press F2. If you want to save to memory C, press F3.

The settings that will be stored (frequency, AC voltage, DC voltage, and waveform bank number) are displayed in the entry area.

4 Press SAVE (F4) to save the settings.

The present settings are stored. To cancel saving, press CANCEL (F5).

Recalling from preset memory

Recalling is not possible in the following situations.

Power line abnormality simulation is in progress.

Sequences are running.

Soft start or soft stop is in progress.

The settings to be recalled are outside the range of the present limit function or protection function.

The output voltage range is L, and the voltage setting to be recalled exceeds the L range.

The peak value of the AC+DC waveform is outside the output voltage range.

There are two recall methods. One method is to check the contents of the memory first and then recall them (this is the default setting), and the other is to recall without checking the contents first.

■ Setting the preset memory recall method

1 Press **MEMORY > PRESET (F1) > RECCONF (F5)**.

2 To check the contents of the memory first and the recall, press **ON (F2)**.
To recall without checking the contents of the memory, press **OFF (F3)**.

This completes the setting.

■ Recalling settings from preset memory

1 Press **MEMORY > PRESET (F1) > RECALL (F1)**.

2 Select the memory (**A, B, C**) you want to recall from.

If you want to recall from memory A, press F1. If you want to recall from memory B, press F2. If you want to recall from memory C, press F3.

If the product is configured to recall the contents of the memory without checking them first, the contents are recalled and applied.

If the product is configured to check the contents of the memory first and then recall them, the settings that will be recalled (frequency, AC voltage, DC voltage, and waveform bank number) are displayed in the entry area. Proceed to step 3.

3 Press **RECALL (F4)** to recall the contents from memory.

The contents are recalled and applied. To cancel recalling, press **CANCEL (F5)**.

Setting the date and time (time zone)

The date and time are used to assign the time of creation of the files saved to the setup memory or USB memory device.

If you change the time zone, the year, month, and day change accordingly.

If the product is connected to LAN and can access the Internet, the year, month, and day will be updated automatically when you set the time zone.

1 Press CONFIG (SHIFT+OPR MODE) > 1/3 (F6) > DATE TIM (F1).

2 Set the time zone and the date and time. After you have finished configuring the settings, press ESC.

A border is displayed around the item that you are setting. Use ▲ (F1), ▼ (F2), or rotary knob to switch between the items you want to set.

Press EDIT (F3) and then use the numeric keypad or rotary knob to edit the content.

Press ADJUST (F4) to adjust the date and time.

To cancel editing, press CANCEL (F6).

Parameter		Description
Auto clock adjust	OFF(F5)	Disables auto clock adjustment.
	ON(F6)	Enables auto clock adjustment.
DateTime	OK(F5)	Sets the date and time. YYYY/MM/DD HH:MM:SS This is valid when Auto clock adjust is set to OFF.
	CANCEL(F6)	Cancels the setting of the date and time.
Time Zone	OK(F4)	Sets the time zone.
	CANCEL(F5)	Cancels the setting of the time zone.
NTP Server name	OK(F4)	Sets the NTP server. This is valid when Auto clock adjust is set to ON.
	CANCEL(F5)	Cancels the setting of the NTP server.

3 Press APPLY (F5) to confirm the date and time.

The new values will be applied. If you specify a day that does not exist (for example, February 30), the settings will be changed to the first day of the following month.

Using the internal setup memory

Up to 10 sets of panel settings (p.192) can be saved to the internal setup memory and recalled.

Saving to the setup memory

Set the date and time before saving to the setup memory (p.77).

- 1 Set up the configuration you want to save.**
- 2 Press MEMORY > SETUP (F3) > SAVNo (F3).**
- 3 Use the numeric keypad or the rotary knob to select the memory number where you want to store the configuration.**
The memory number is shown in the entry area.
- 4 Press SAVE (F4) to save the settings.**
The present settings are stored. To cancel saving, press CANCEL (F5).

Recalling from the setup memory

Recalling is not possible when the output is on, while power line abnormality simulation or sequences are running, or when soft start or soft stop is being performed.

- 1 Press MEMORY > SETUP (F3) > RCL No (F1).**
- 2 Use the numeric keypad or the rotary knob to select the memory number that you want to recall.**
The memory number is shown in the entry area.
- 3 Press RECALL (F4) to recall the contents from memory.**
The contents are recalled and applied. To cancel recalling, press CANCEL (F5).

Using a USB memory device

The following items can be saved to a USB memory device.

- Panel settings (items that can be saved to the setup memory)

- Power line abnormality simulation settings

- Sequence data

- Selected waveform bank data

All items that can be saved (present output method, panel settings, power line abnormality simulation settings, sequence data, all waveform bank data)

You cannot use a USB memory device that has a capacity greater than 16 GB.

Use a PC to format the USB memory device (into FAT32 format).

Some USB memory devices may not operate correctly.

USB error messages

If there is a problem with the USB memory device, an error will occur. Error messages are displayed when errors occur.

Error message	Description
Data out of range. (Line = the line number)	A setting is outside of its range.
Disk access error. (Error code)	A USB memory device read or write error occurred.
Disk error. (Error code; line = the line number)	An error not listed here occurred.
Disk full.	There is no free space in the USB memory device.
Disk mount error.	The mounting of the USB memory device failed.
File not found.	The file could not be found.
Illegal parameter. (Line = the line number)	A parameter was illegal.
No disk.	A USB memory device is not connected.
Not supported. (Line = the line number)	The read operation is not supported.
Path not found.	The path (folder) could not be found.
Settings conflict. (Line = the line number)	Conditions that are not allowed
Syntax error. (Line = the line number)	The delimiter character could not be found.

Folders where the files are saved and file names

The following folders are created in the root folder of the USB memory device, and the data is saved.

You cannot delete or rename folders from the product. Use a PC to perform these operations.

Use alphanumeric characters for the folder names. You cannot use the following characters: \, /, *, ?, ", <, >, |

Do not change the file name.

Saved contents	Created folder* ¹	File name* ¹	Conditions that are not allowed
Panel settings	PCRWE\SET\SETxxx	SET_1P.json SET_3W.json SET_3P.json	Output on sequence is running Soft start or soft stop is in progress.
Power line abnormality simulations	PCRWE\SIM\SIMxxx	SIM_1P.json SIM_3W.json SIM_3P.json	—
Sequence data	PCRWE\SEQ\SEQxxx	SEQ_1P.json SEQ_3W.json SEQ_3P.json	—
Waveform bank contents	PCRWEWAVE	WAVExxx.json	sequence is running Soft start or soft stop is in progress.
All	PCRWE\ALL\ALLxxx	wiring.json* ²	Output on
	PCRWE\ALL\ALLxxx\SETxxx	SET_1P.json SET_3W.json SET_3P.json	sequence is running Soft start or soft stop is in progress.
	PCRWE\ALL\ALLxxx\SIMxxx	SIM_1P.json SIM_3W.json SIM_3P.json	
	PCRWE\ALL\ALLxxx\SEQxxx	SEQ_1P.json SEQ_3W.json SEQ_3P.json	
	PCRWE\ALL\ALLxxx\WAVE	WAVE001.json to WAVE256.json	

*1. The "xxx" in the folder or file name is a sequence number (001 to 999) that is automatically appended to the file name.

*2. Output method when saving

Saving to a USB memory device

Set the date and time before saving to the a USB memory device (p.77).

- 1** Set up the configuration you want to save.
- 2** Connect a USB memory device to the USB port on the front panel.
- 3** Press OTHERS (SHIFT+MEMORY) > 1/2 (F6) > FILE (F5) > SAVE (F3).
- 4** Select the item that you want to save.

Parameter	Description
SET(F1)	Panel settings
SIM(F2)	Power line abnormality simulations
SEQ(F3)	Sequence data
WAVE(F4)	Waveform bank contents
ALL(F5)	All contents that can be saved

The name of the file that the data will be saved to is displayed in the entry area. When you are saving a waveform bank, the number of the waveform bank that you are saving and the file name are displayed.

- 5** To save a waveform bank, use the rotary knob to select the number of the waveform bank that you want to save to.

For single-phase three-wire output or three-phase output, if you are saving a user-defined waveform, select the phase that you want to save using PHASE SEL (F3).

You cannot use the numeric keypad.

- 6** Press SAVE (F4) to save the settings.

Do not remove the USB memory device until "File was saved" disappears.

The present settings are stored. To cancel saving, press CANCEL (F5).

- 7** Remove the USB memory device from the USB port.

Recalling panel settings, power line abnormality simulation, or sequence data from a USB memory device

Panel settings cannot be recalled when the output is on, while power line abnormality simulation or sequences are running, or when soft start or soft stop is being performed.

If you recall power line abnormality simulation data while a simulation is in progress, the recall data is applied the next time the simulation is run.

If you recall sequence data while a sequence is running, the recall data is applied the next time the sequence is run.

- 1** Connect a USB memory device to the USB port on the front panel.
- 2** Press OTHERS (SHIFT+MEMORY) > 1/2 (F6) > FILE (F5) > LOAD (F1).
- 3** Select the item that you want to recall.

Parameter	Description
SET(F1)	Panel settings
SIM(F2)	Power line abnormality simulations
SEQ(F3)	Sequence data

The name of the file saved to the USB memory device is displayed.

- 4** Use the rotary knob to select the file that you want to recall.
- 5** Press LOAD (F4) to recall the file.
Do not remove the USB memory device until "File was loaded" disappears.
The contents are recalled and applied. To cancel recalling, press CANCEL (F5).
- 6** Remove the USB memory device from the USB port.

Recalling waveform bank data or all contents that can be saved

Recalling is not possible when the output is on, while power line abnormality simulation or sequences are running, or when soft start or soft stop is being performed.

- 1** Connect a USB memory device to the USB port on the front panel.
- 2** Press OTHERS (SHIFT+MEMORY) > 1/2 (F6) > FILE (F5) > LOAD (F1).
- 3** Select the item that you want to recall.

Parameter	Description
WAVE(F4)	Waveform bank contents
ALL(F5)	All contents that can be saved

The name of the file saved to the USB memory device is displayed.

- 4** Use the rotary knob to specify the number of the waveform bank that the recalled waveform bank will be saved in, and then press FILE SEL (F2).

You cannot use the numeric keypad.

For single-phase three-wire output or three-phase output, if you are recalling a user-defined waveform, select the phase that you want to recall using PHASE SEL (F3).

- 5** Use the rotary knob to select the file that you want to recall.

Press WB No. (F1) to change the number of the waveform bank that the recalled waveform bank will be saved in. You cannot use the numeric keypad.

- 6** Press LOAD (F4) to recall the file.

Do not remove the USB memory device until "File was loaded" disappears.

The contents are recalled and applied. To cancel recalling, press CANCEL (F5).

- 7** Remove the USB memory device from the USB port.

Advanced Functions

Using the Sync Function

The sync function synchronizes the frequency and phase of the product's output voltage to a 50 Hz or 60 Hz input power supply or external sync input signal (EXT SYNCHRO).

This is useful in situations such as when the display of an external measuring instrument is not stable.

To finely control the synchronization phase of the input voltage on three-phase input models, set the synchronization delay phase angle.

This function operates when the lower frequency limit is less than 45 Hz and the upper frequency limit is greater than 65 Hz.

This is invalid when the product is being controlled with an external analog signal and the signal source is set to external signal (EXT) only or when the product is being controlled with an external analog signal and the frequency is being varied using an external DC signal.

■ Selecting the input sync signal

You can select whether to synchronize to the input power supply or external sync input signal.

To synchronize to an external sync input signal, you need to set selectable I/O to SYNC CLK IN ([p.174](#)).

Press SYNC (SHIFT+9) > SOURCE (F5) to select the input sync signal.

Parameter	Title		Description
LINE(F2)	Sync Source	Line	Synchronizes to the input power supply
EXT(F3)		External	Synchronizes to an external sync input signal

■ Setting the synchronization delay phase angle

Press SYNC (SHIFT+9) > DELAY (F4) to set the value.

Parameter	Title	Description
DELAY(F4)	Sync delay angle	Sets the synchronization delay phase angle (0.0 deg to 360.0 deg)

■ Turning the sync function on and off

If the input voltage frequency is outside of the rated range or if the input power supply voltage distortion and the noise are extremely large, synchronization is not possible. SYNC NG or EXT SYNC NG will be displayed.

Press SYNC (SHIFT+9) to turn the sync function on and off.



Parameter	Title	Description
ON(F2)	Sync	Using the Sync Function When the input sync signal is set to LINE SYNC or SYNC+P*1 blinks until synchronization is established. After a few seconds, the frequency and the phase are synchronized, SYNC or SYNC+P lights, and the synchronized frequency is displayed. When the input sync signal is set to EXT EXT SYNC or EXT SYNC+P*1 blinks until synchronization is established. After a few seconds, the frequency and the phase are synchronized, EXT SYNC or EXT SYNC+P lights, and the synchronized frequency is displayed.
OFF(F3)		The sync function is disabled.

*1. +P is displayed when the synchronization delay phase angle is set.

■ The frequency that is used when the sync function is cleared

If the frequency when you are using the sync function is within the frequency limits, the frequency is set to the 50 Hz or 60 Hz, whichever the PCR-WE was synchronized to.

For example, if the input frequency is 48 Hz, the panel displays “50.--” and synchronizes at 48 Hz. If you release the sync function, the frequency value is set to 50.00 Hz.

■ Phase

The figure below shows the phase synchronization behavior for different input-wiring and output configurations.

Input wiring	1P output 1P3W output	3P output
<p>1P input</p>	<p>In-phase with the input</p>	<p>V_{U-N} and V_{L-N} are in phase.</p>
<p>3P3W 200 V input</p>	<p>In-phase with input V_{R-S}</p>	<p>V_{U-N} and V_{R-S} are in phase.</p>
<p>3P4W 400 V input</p>	<p>In-phase with input V_{R-N}</p>	<p>In-phase with the input</p>

Using the Compensation (Voltage compensation) Function

The compensation function compensates for voltage drops in the load cables when the load is connected to the product over a long distance. This product has three types of compensation functions: hard sensing, soft sensing, and regulation adjustment. Use the different compensation functions depending on how you need to use the PCR-WE.

Regulation adjustment is invalid for single-phase three-wire output and three-phase output.



WARNING Risk of electric shock.

- **Before you connect the load or sensing cables, turn the POWER switch off, and then turn off the switchboard.**
- **Firmly attach the terminal box cover.**

- Hard sensing

Connect the PCR-WE's internal output voltage compensation point directly across the load. Because compensation is performed in real time, the output voltage can be stabilized at a high speed.

Hard sensing can compensate the voltage up to approximately 1.5 V for a single line.

Because the impedance (the combination of the resistance and the inductance) of the power line across the load will be included in the compensation circuit, the power circuit's stability decreases. The PCR-WE operations may become unstable (for example, it may oscillate) depending on the wiring and the load type. Because the power wires of each phase (L and N) are not paired for single-phase three-wire output or three-phase output, the operation tends to be more unstable than for single-phase output. If the operations become unstable, use soft sensing.

It is recommended that you use soft sensing if you are using a load that does not require a fast output voltage response speed.

Hard sensing cannot be set if the output impedance is turned on.

- Soft sensing

The voltage of the sensing point is measured by the PCR-WE measurement functions, and any insufficiencies in the voltage are automatically compensated for. The performance of the product such as the stability of the voltage, output voltage response to sudden changes in the load current, and waveform quality (distortion ratio) is lower than the product's normal performance.

Soft sensing can compensate the voltage up to $\pm 10\%$ of the product's set voltage. The maximum output voltage during compensation is limited by the rated voltage of the PCR-WE.

If compensation cannot be completed within 3 seconds (response speed: 100 ms), "SENS.-S" is displayed in red on the panel.

Soft sensing cannot be set in the following situations.

Output impedance is turned on.

The action to perform when the current limit is exceeded is set to DISABLE.

Soft start and soft stop are on.

When the external analog input function (EXTDC, VPROG) is in use.

Soft sensing does not operate in the following situations. "SENS.-S" is displayed in red on the panel.

A waveform bank number other than zero is specified.

The controlled parameter is AC, the DC voltage setting is greater than 0 V, the AC voltage setting is less than 10 V, and the frequency setting is less than 40 Hz.

The controlled parameter is DC, the AC voltage setting is greater than 0 V, the DC voltage setting is less than 10 V.

When the external analog input function (EXTDC, VPROG) is in use.

- Regulation adjustment

This function calculates the voltage drops that are caused by the output current and increases the output voltage just by the calculated voltage drops.

Use this function when there is a great distance between the PCR-WE and the load and you want to stabilize the voltage across the load. This function does not require you to connect the sensing cables that the hard sensing and soft sensing functions require.

The performance of the stabilization accuracy, distortion ratio, and response speed of the voltage is lower than the normal performance of the PCR-WE. Depending on how you are using the PCR-WE, you may not be able to use this function. Check the operation that you will perform before you use the regulation adjustment function.

Regulation adjustment can compensate the voltage up to +10 % of the product's output voltage. The maximum output voltage during compensation is limited by the rated voltage of the PCR-WE. If the output current is 10 % or less of the maximum rated current, the voltage is not compensated.

Regulation adjustment is not possible in the following situations.

Output impedance is turned on.

The action to perform when the current limit is exceeded is set to DISABLE.

A waveform bank number other than zero is specified.

Soft start and/or soft stop are on.

When the external analog input function (EXTDC, VPROG) is in use.

Wiring the hard sensing and soft sensing functions

We recommend that you run the load wires alongside each other and tie them together at several points with cable ties. Connect between the output terminal and load with the shortest wires possible.

Hard sensing can compensate up to approximately 1.5 V for a single line. Soft sensing can compensate up to approximately $\pm 10\%$ of the voltage setting. Select a load cable that has sufficient current capacity to prevent the voltage drop in the cable from exceeding the compensation voltage.

As the PCR-WE output voltage becomes small, so too does the detected voltage. If the product's output voltage is small, reduce the voltage drops in the cables by using cables that have large diameters to wire the load, connecting the load so that the cables are as short as possible, and taking other similar precautions.

CAUTION Risk of damage to the product and the load. If the sensing cables become disconnected or the polarities are incorrect, an overvoltage will be generated in the output. The protection function will be activated and the output will be turned off, but an overvoltage will be generated for the several hundreds of milliseconds before the protection function is activated.

Use AWG22 to AWG16 cables when connecting to the sensing terminals. Strip approximately 10 mm of coating from the end of the cable.

OUTPUT terminal block and SENSING terminal block (PCR1000WE example)

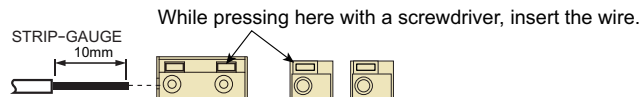
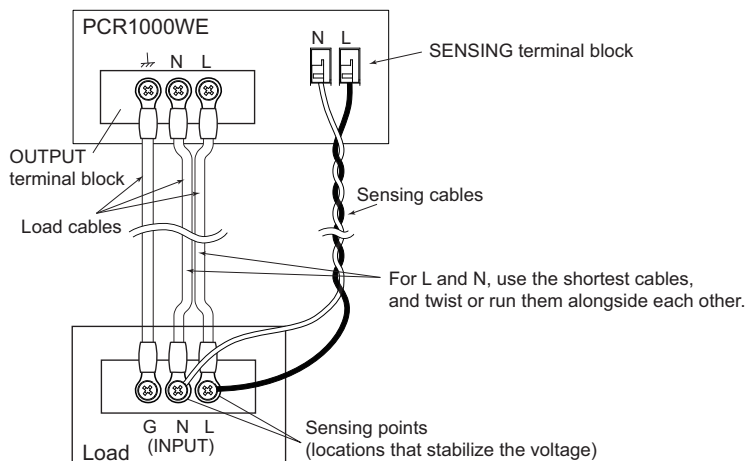

The shapes of the terminal blocks vary depending on the model.

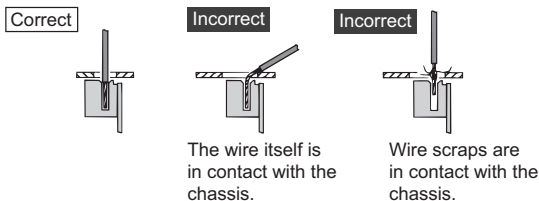

1 Turn the **POWER** switch off.

2 Turn off the load's power switch.

If the load's power switch cannot be turned off, provide a dedicated terminal block for sensing. Do not connect the load to the dedicated terminal block for sensing.

3 In the case of the **PCR1000WE/PCR2000WE/PCR3000WE2**, remove the two **M3** screws from the **SENSING** terminal cover, and then remove the cover.

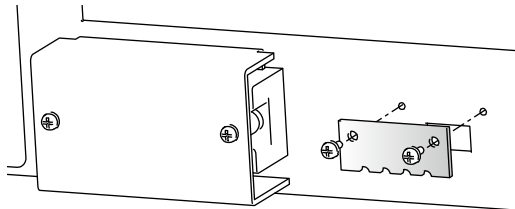

Example of PCR1000WE

In the case of the **PCR-WE2** (except the PCR3000WE2), remove the three **M4** screws from the terminal cover, and then remove the cover.

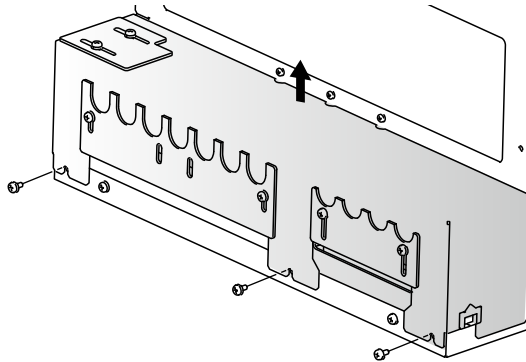

Example of PCR36000WE
(three phase 400 V input)

4 Connect the cables by referring to the following sensing wiring diagrams.

Connect the cables as close to the load as possible.

- 1P output

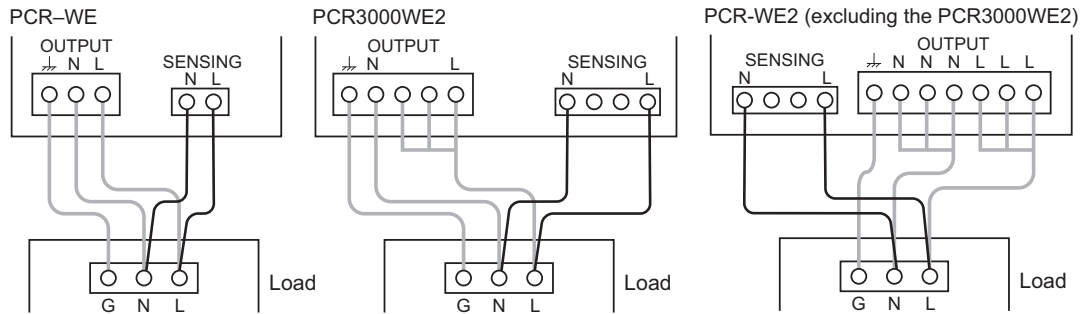

- 1P3W output

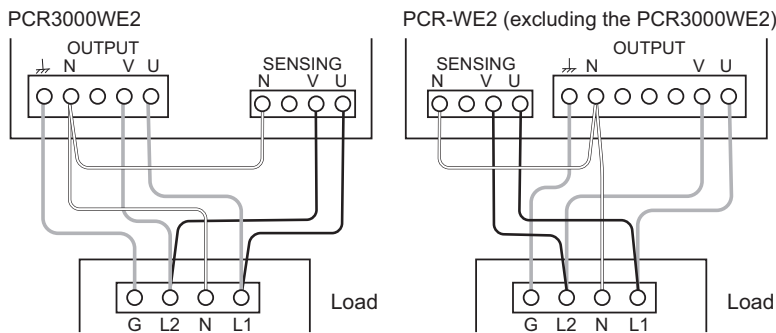

- 3P output

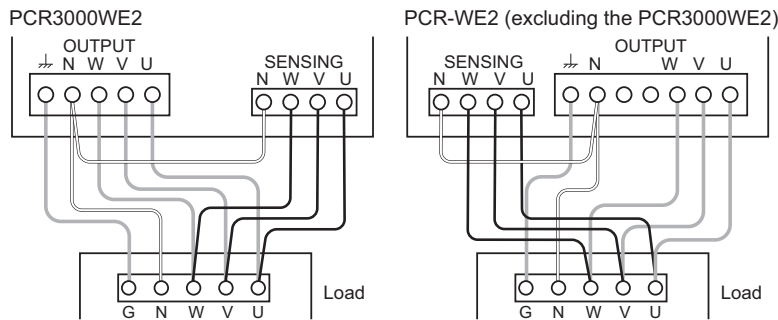

5 Use the included cable tie to gently tie the cables as shown below.

The cable tie can be reused. Do not cut the extraneous portion of the tie.

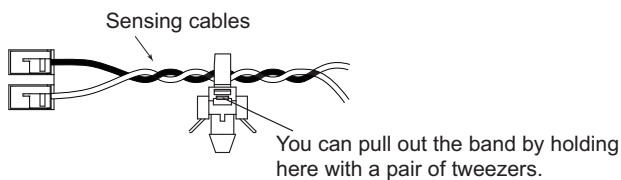

6 Attach the tip of the cable tie to the product as shown below.

PCR1000WE
PCR2000WE
PCR3000WE2

PCR6000WE2/ PCR12000WE2
PCR18000WE2/ PCR24000WE2
PCR30000WE2/ PCR36000 WE2

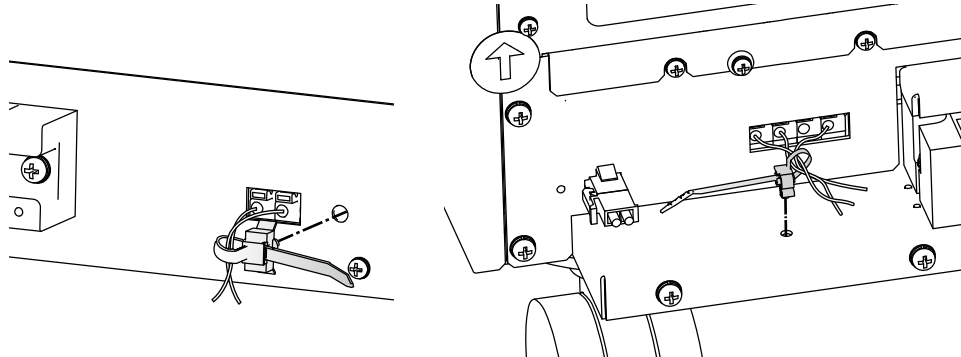

7 Firmly tighten the cable tie so that the sensing cables do not come loose.

8 In the case of the PCR1000WE/PCR2000WE/PCR3000WE2, attach the SENSING terminal cover. In the case of the PCR-WE2 (excluding the PCR3000WE2), attach the terminal cover.

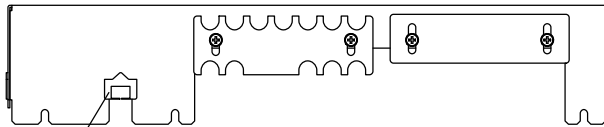

For the PCR6000WE2/PCR12000WE2, run the sensing cables through here.
For the PCR18000WE2/PCR24000WE2/PCR30000WE2/PCR36000WE2, run the sensing cables through the gap in the OUTPUT terminal block.

Checking the sensing cables

When you are using the hard sensing function or soft sensing function, after you finish wiring the sensing cables, check that there are no wiring errors. Turn the load's power switch off before you perform this check.

- 1** Turn the **POWER** switch on.
- 2** Set the output undervoltage protection (UVP) to 5 V.
- 3** Set the output overvoltage protection (OVP) to 20 V.
- 4** Set the output voltage range to the H range.
- 5** Set the output voltage to 10 V, and then turn the output on.
- 6** Check whether a voltage of several tens of volts is being generated.

An output being generated in this situation indicates that there are connection errors. Check whether the sensing cables are connected and whether the polarities are correct. If the sensing cables are disconnected or the polarities are incorrect, a voltage will be applied across the load (at the sensing point) for approximately 1 second until the protection function is activated.

If the sensing cables are not firmly connected, an alarm (ALM-07: UVP or ALM-22: SENSING FAILURE) may be generated. If the polarities of the sensing cables are not correct, an alarm (ALM-00: OVP) may be generated. Connect the cables correctly.

If you are using a dedicated terminal block for sensing, check the sensing function and then connect the load to the terminal block.

Wiring the regulation adjustment function

After you finish connecting the load, turn the output on. Then, set the output voltage to the voltage that is required across the load. Because of voltage drops in the load wiring, the voltage across the load is lower than the voltage generated by the PCR-WE. Use a voltmeter (or other instrument that enables you to measure voltage) to check whether the voltage across the load is the required voltage during regulation adjustment.

Regulation adjustment can compensate the voltage up to +10 % of the product's output voltage.

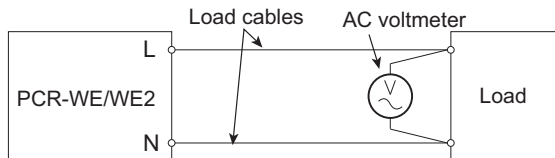

Compensation function setup procedure

Set the voltage and the frequency that you want to stabilize at the sensing point. For DC output, set only the voltage.

The hard sensing function is used.

Hard sensing cannot be used if the output impedance is turned on.

- 1 Turn off the output.**
- 2 Press OTHER (SHIFT+MEMORY) > 1/2 (F6) > COMPEN (F2) > SENS.-H (F2) to select hard sensing.**
- 3 Press ENT.**

“SENS.-H” is displayed on the panel.



This completes the setting.

The soft sensing function is used.

Soft sensing cannot be set in the following situations.

- Output impedance is turned on.

- The action to perform when the current limit is exceeded is set to DISABLE.

- Soft start and/or soft stop are on.

- When the external analog input function (EXTDC, VPROG) is in use.

Soft sensing does not operate in the following situations.

- A waveform bank number other than zero is specified.

- The controlled parameter is AC, the DC voltage setting is greater than 0 V, the AC voltage setting is less than 10 V, and the frequency setting is less than 40 Hz.

- The controlled parameter is DC, the AC voltage setting is greater than 0 V, the DC voltage setting is less than 10 V.

1 Turn off the output.

2 Set the output voltage.

You cannot change the output voltage while the soft sensing function is in use.

3 Press OTHER (SHIFT+MEMORY) > 1/2 (F6) > COMPEN (F2) > SENS.-S (F3).

4 Press ENT.

“SENS.-S” is displayed on the panel.



5 Press 1/2 (F6) > SOFT.SENS (F2) > S.POINT (F5) to set the sensing point.

Set the sensing point.

Parameter	Title	Description
O.TERM(F2)	Sensing Point	Output terminal (output voltage correction function)
S.TERM(F3)		Sensing terminal (load wire voltage drop correction function)

6 Press ESC > V.CTRL (F2) to set the controlled parameter.

Parameter	Title	Description
AC(F2)	Voltage Control	AC voltage is to be corrected.
DC(F3)		DC voltage is to be corrected.

This completes the setting.

The regulation adjustment function is used.

Regulation adjustment is not possible in the following situations.

Output impedance is turned on.

The action to perform when the current limit is exceeded is set to DISABLE.

A waveform bank number other than zero is specified.

Soft start and/or soft stop are on.

For single-phase three-wire output or three-phase output

- 1** Turn off the output.
- 2** Press OTHER (SHIFT+MEMORY) > 1/2 (F6) > COMPEN(F2) > REG ADJ (F4) to select regulation adjustment.
- 3** Press ENT.
“REG-ADJ” is displayed on the panel.

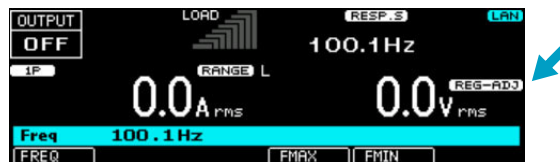

This completes the setting. Next, perform adjustments.

- 4** Turn on the output.
- 5** Run a current that is at least 10 % of the maximum rated current through the load. Then, check the voltmeter that is connected across the load, and use the rotary knob to adjust the voltage to the same value that is displayed.

This completes the adjustment procedure. Press ESC to return to the home position.

Ending the use of the compensation function



Press OTHER (SHIFT+MEMORY) > 1/2 (F6) > COMPEN (F2) > OFF (F1) to end the use of the compensation function.

Using Power Line Abnormality Simulations

You can simulate power supply line errors by stopping the PCR-WE output (to simulate power failures) and decreasing and increasing the voltage (to simulate voltage dips and pops).

You can use this to test switching power supplies and other electronic devices.

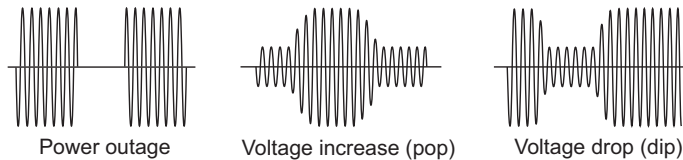

A sine wave is generated during the power line abnormality simulations. Even if a special waveform is set with the waveform bank, a sine wave will be generated as soon as you execute the power line abnormality simulation.

You can set this function regardless of whether the output is on or off.

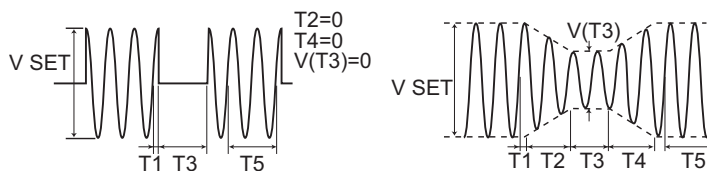

Parameter	Description
POL	Voltage regulation start polarity
T1	Voltage regulation start time or voltage regulation start phase. This is the time or the phase from the waveform's zero crossing (the point where the signal crosses the zero axis) to the point where voltage regulations—such as increases or decreases—start to occur.
T2	Slope time 1. For pops, this indicates how much time is required to raise the voltage to the pop voltage. For dips, this indicates how much time is required to lower the voltage to the dip voltage.
T3	Voltage regulation time. For pops, this indicates the length of time that the voltage will be kept at the voltage that it has been raised to (the pop voltage). For dips, this indicates the length of time that the voltage will be kept at the voltage that it has been lowered to (the dip voltage).
T4	Slope time 2. For pops, this indicates how much time is required to lower the voltage from the pop voltage to the voltage that is in use during the period indicated by T5. For dips, this indicates how much time is required to raise the voltage from the dip voltage to the voltage that is in use during the period indicated by T5.
T5	Return time or return cycles. This indicates how long (either as a length of time or as a number of cycles of the present frequency) the voltage will be kept at the level that it returns to after a pop or dip is completed.
T3VOLT	Regulated voltage. For pops, this is the voltage level that the voltage will be raised to (the pop voltage). For dips, this is the voltage level that the voltage will be lowered to (the dip voltage).
LOOP	Number of times to repeat repetition count T1 to T5.

NOTE

Voltage regulation start polarity

You can set the zero crossing (the time at which the voltage becomes zero) that will be the reference for T1 to positive zero crossing or negative zero crossing by switching the voltage regulation start polarity (POL). You can use this function to change the phase by 180°. Output voltage (waveform) of L is indicated relative to N of the PCR-WE's OUTPUT terminal block.

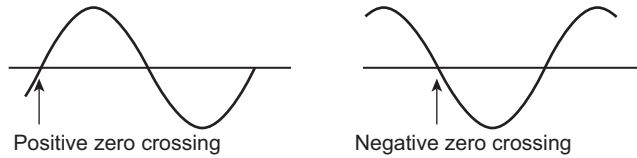

Power line abnormality simulation setup procedure

You cannot set limits when the sync function is on. You can set this function regardless of whether the output is on or off.

1 Set the steady-state voltage and frequency.

2 Press SIM > COND (F4) to set the conditions.

A border is displayed around the item that you are setting. Use \uparrow , \downarrow , or rotary knob to switch between the items you want to set.

Parameter		Description
POL	-	Sets the voltage regulation start polarity to negative zero crossing
	+	Sets the voltage regulation start polarity to positive zero crossing
T1 TYPE	TIME	Sets the voltage regulation start using time
	ANGLE	Sets the voltage regulation start using phase
T5 TYPE	TIME	Sets the period that the voltage remains at the returned level using time
	CYCLE	Sets the period that the voltage remains at the returned level using cycles

3 Press ESC to return to the previous screen.

4 Press EDIT (F5) to set the parameters (T1 to T5 and T3 VOLT).

A border is displayed around the item that you are setting. Use \uparrow , \downarrow , or rotary knob to switch between the items you want to set.

Parameter	Title	Description
T1	T1 Time	Sets the voltage regulation start time (0.0 ms to 999.9 ms)
	T1 Angle	Sets the voltage regulation start phase (0 deg to 359.9 deg)
T2	T2 Time	Sets slope time 1 (0 ms to 99 990 ms)
T3	T3 Time	Sets the voltage regulation time (0.1 ms to 9 999.0 ms)
T4	T4 Time	Sets slope time 2 (0 ms to 99 990 ms)
T5*1	T5 Time	Sets the return time (0 ms to 99 990 ms)
	T5 Cycle	Sets the number of return cycles (0 to 999 900)
T3 VOLT	T3 Volt	Sets the regulated voltage (L range: 0 V to 157.5V, H range: 0 V to 315.0 V)

*1. Depending on how T1 to T4 are set, this may lead or lag by one cycle.
If you set this to a value that is not an integer multiple of one cycle, the return time will last longer than the time you have specified because the PCR-WE will wait for a zero crossing during the T1 execution time.

5 Press ESC to return to the previous screen.

6 Select LOOP (F3) to set the number of repetitions.

Parameter	Title	Description
LOOP	Loop	Sets the number of repetitions (1 to 9 999, where 9 999 indicates unlimited repetitions)

This completes the setting.

Executing and stopping power line abnormality simulations

You cannot execute power line abnormality simulation in the following situations.

- The action to perform when the current limit is exceeded is set to DISABLE.
- The regulation adjustment or soft sensing compensation function is in use.
- L range is selected and T3 VOLT is set to a value outside of its range.
- T3 VOLT is set to a value outside the voltage limits.

1 Press **OUTPUT** to turn output on.

2 Press **SIM > RUN (F1)** to execute a power line abnormality simulation.

During execution, press **STOP (F1)** to stop the simulation. Press **OUTPUT** to turn output off and stop the simulation.

Status signal output

Status signals are only generated during the periods defined by T2, T3, and T4 (period T3 when T2 and T4 both equal zero).

The status signal output must be mapped to the DIGITAL I/O connector on the product's rear panel. For details, see "DIGITAL I/O connector pin arrangement and mapping" ([p. 163](#)).

There is a slight time difference (approximately 100 μ s) between the status signal output and changes to the actual output.

Status signals may be output when you change the settings of the various parameters.

Using the Harmonic Analysis Function

You can perform harmonic analysis on the output voltage and output current. A simplified measurement method is used, so this method does not conform to standards such as IEC. For standard-compliant measurements, use the Kikusui Harmonic/Flicker Analyzer KHA3000.

The analyzed harmonic varies depending on the output frequency.

Frequency	Analyzed harmonic
1 Hz to 100 Hz	50th
100.1 Hz to 200 Hz	25th
200.1 Hz to 300 Hz	16th
300.1 Hz to 400 Hz	12th
400.1 Hz to 500 Hz	10th
500.1 Hz to 600 Hz	8th
600.1 Hz to 700 Hz	7th
700.1 Hz to 800 Hz	6th
800.1 Hz to 1000 Hz	5th

Press OTHERS (SHIFT+MEMORY) > FFT (F5) to set the parameter you want to view.

Parameter	Description
ALL	Displays all harmonics
ODD	Displays odd harmonics
EVEN	Displays even harmonics
AMPER	Displays the harmonic current
VOLT	Displays the harmonic voltage

The measured value of the 0th harmonic is a DC value. The measured values of 1st to the 50th harmonic are rms values.

THD is the total harmonic distortion (ratio of the harmonic components up to the 50th harmonic relative to the fundamental component).

U degree is the phase difference (± 180 deg) from the U-phase fundamental voltage waveform.

Order	U degree	U Vrms
1	0.00	0.00
3	0.00	0.00
4	0.00	0.00

Generating Special Waveforms (Waveform bank)

Peak clipped waveforms and flat curve waveforms can be output.

You can use remote control to configure user-defined waveforms. For details, see the Communication Interface Manual on the included CD-R.

This product creates reference waveforms for output voltage by performing D/A conversion on the data that is stored in its internal memory.

A cycle (360° phase angle) is 12 bits horizontal and 16 bit vertical.

The reference voltage waveform of the PCR-WE is a sine wave. A sine wave whose positive peak is 32767 and negative peak is -32767 is assigned.

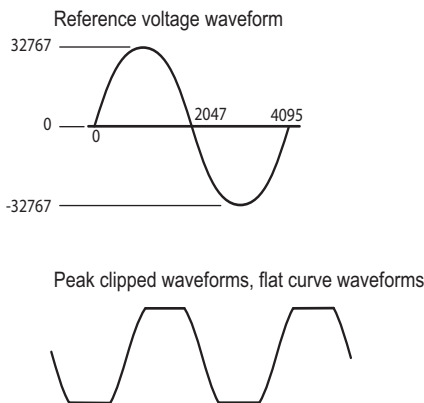

- Waveform bank

The stored waveform data in memory that corresponds to one waveform is referred to as a waveform bank. This product has 257 waveform banks. Each bank is assigned a number from 0 to 256, which is used to select the waveform. Waveform bank 0 consists of calculated sine wave data with a phase setting resolution of 0.01°. This bank cannot be overwritten.

In the factory default condition, all waveform banks contain sine waves.

- Peak-clipped waveform

The peak portion of waveforms is clipped by the specified crest factor value. The sine waveform is adjusted so that the specified rms value and the rms value of the waveform that is actually output are the same.

The crest factor is the ratio of the AC waveform's peak value to its rms value.

Crest factor = peak value/rms value.

For a sine wave, the crest factor is 1.41. In the voltage waveforms of commercial power lines, the peaks are clipped, so the crest factor is between 1.2 and 1.4.

- Flat curve waveform

This is a waveform defined in IEC61000-4-13.

The peak of the waveform is clipped by the specified clip factor (the waveform peak is defined to be 1). The specified rms value and the rms value of the waveform that is actually output are not the same.

For single-phase three-wire output, the same waveform is assigned to all phases. For three-phase output, all phases can be set collectively or each phase can be set separately.

If the compensation function is set to regulation adjustment, only waveform bank 0 can be selected.

Setting the waveform bank

You cannot set the waveform bank when the sync function is running or when the external analog input function (EXTDC, VPROG) is in use.

The PCR-WE cannot use waveforms created with the PCR-LE.

- 1** Press **OTHERS (SHIFT+MEMORY) > WAVE (F2) > EDIT (F5)**.
- 2** Press **EWB No. (F1)** to select the number (1 to 256) of the waveform bank you want to set.
- 3** **Select the waveform.**
If you select the peak clipped waveform, also set the crest factor. If you select the flat curve waveform, also set the clip factor.

Parameter	Title	Description
SIN(F3)	Edit WB No.	Selects the sine wave
P.C(F4)		Sets the crest factor of the peak-clipped waveform (1.10 to 1.40)
FLT.C(F5)		Sets the clip factor (0.4 to 1.0) of the flat curve waveform

- 4** **Press APPLY (F4).**
This completes the setting. To cancel the setting, press **CANCEL (F5)**.

Generating special waveforms

You can generate special waveforms regardless of whether the output is on or off.

When you set the compensation function to regulation adjustment or soft sensing, you cannot change the waveform bank number while the soft start is being performed, soft stop is being performed, or when the product is being controlled with an external analog signal and the signal source is set to external signal (EXT) only.

1 For single-phase output, for single-phase three-wire output, and for three-phase output when setting all phases collectively, press OTHERS (SHIFT+MEMORY) > WAVE(F2). For three-phase output when setting each phase separately, press OTHERS (SHIFT+MEMORY) > WAVE (F2) > 1/2 (F6).

2 Select the number (0 to 256) of the waveform bank you want to output.

3 Press APPLY (F4).

To cancel the setting, press CANCEL (F5).

For single-phase output and single-phase three-wire output, when the output waveform bank number is not zero, "S.WAVE" will be displayed. For three-phase output, when the waveform bank numbers of all phases U, V, and W are not zero, "S.WAVE" will be displayed.

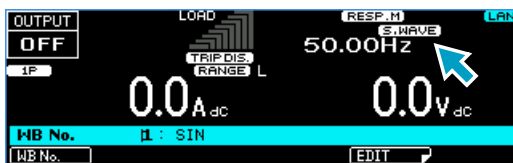

Parameter	Title	Description
WB No.(F1)	WB No.	Specifies the number of the waveform bank that you want to output
2/2(F6) > U WB No.(F1)	U WB No.	Specifies the number of the waveform bank that you want to output for the U phase
2/2(F6) > V WB No.(F2)	V WB No.	Specifies the number of the waveform bank that you want to output for the V phase
2/2(F6) > W WB No.(F3)	W WB No.	Specifies the number of the waveform bank that you want to output for the W phase

This completes the setting.

If the output is on, the selected waveform will be generated. If the output is off, press OUTPUT to turn the output on and generate the selected waveform.

Stopping the generation of the special waveform (returning to a sine wave)

To stop generating the special waveform, select waveform bank number 0.

Setting the Output Impedance

This product's output impedance is approximately $0\ \Omega$. Commercial power supplies have an impedance of several milliohms to several ohms. You can change the output impedance of this product. This enables you to simulate the same environment as that which is provided by commercial power supplies.

If you require official IEC standard test data, use the Kikusui Line Impedance Network (LIN Series).

The output impedance can be turned on only when the compensation function is off.

Press OTHERS (SHIFT+MEMORY) > OUT IMP (F3) to set the output impedance (resistance component).

Parameter	Title	Description
RESI(F1)	Resistance	Sets the output impedance (resistance component). Sets the output impedance (resistance component) of all phases for single-phase three-wire output and three-phase output.
1/3(F6) > RESI U ^{*1} (F1)	Resistance U	Sets the output impedance (resistance component) of the U phase.
1/3(F6) > RESI V ^{*1} (F2)	Resistance V	Sets the output impedance (resistance component) of the V phase.
1/3(F6) > RESI W ^{*1} (F3)	Resistance W	Sets the output impedance (resistance component) of the W phase.

*1. Only for three-phase output

Press OTHERS (SHIFT+MEMORY) > OUT IMP (F3) to set the output impedance (reactance component).

Parameter	Title	Description
REAC(F2)	Reactive	Sets the output impedance (reactance component). Sets the output impedance (reactance component) of all phases for single-phase three-wire output and three-phase output.
1/3(F6) > REAC U ^{*1} (F1)	Reactive U	Sets the output impedance (reactance component) of the U phase.
1/3(F6) > REAC V ^{*1} (F2)	Reactive V	Sets the output impedance (reactance component) of the V phase.
1/3(F6) > REAC W ^{*1} (F3)	Reactive W	Sets the output impedance (reactance component) of the W phase.

*1. Only for three-phase output

Press OTHERS (SHIFT+MEMORY) > OUT IMP (F3) to set the output impedance to on or off. For single-phase three-wire output and three-phase output, all phases are set collectively. They cannot be set separately.

If you select ON, "OUT Z" will be displayed.

When the setting value is outside the specifications range (p.208), "OUT Z" is displayed in red. If the value exceeds the upper limit of the specifications, this operates at the upper limit. If the value is less than the lower limit, this operates at the lower limit.

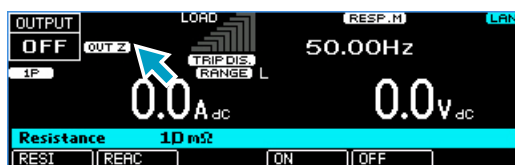

Parameter	Title	Description	Conditions that are not allowed
ON(F4)	Resistance/ Reactive	Enables the output impedance	Compensation function: Enabled
OFF(F5)		Disables the output impedance	—

Configuring Soft Start and Soft Stop

The output voltage can be gradually increased when the output is turned on to control the load device's inrush current (soft start). The output voltage can be gradually decreased when the output is turned off to control the inductive kickback that occurs when the current is cut off (soft stop).

Suppressing the inrush current prevents the voltage from dropping and the output from being turned off as a result of an alarm activation.

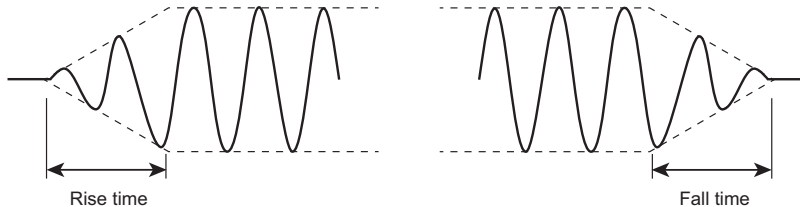

Soft start and soft stop cannot be set when the product is being controlled with an external analog signal and the signal source is set to external signal (EXT) only or when the product is being controlled with an external analog signal and the voltage is being varied using an external DC signal.

When you set soft start to on, "RISE TIM" will be displayed.

When you set soft stop to on, "FALL TIM" will be displayed. When soft stop is being performed, "FALL TIM" blinks.

If you press OUTPUT (turn off the output) when soft start is being performed and soft stop is set to off, the output will be turned off. If soft stop is set to on, soft stop will be performed.

The OUTPUT key is invalid when soft stop is being performed.

Configuring soft start

Press OTHERS (SHIFT+MEMORY) > RISE TIM (F1) to configure soft start.

If you select ON, "RISE TIM" will be displayed.



Parameter	Title	Description	Conditions that are not allowed
ON (F2)	Rise Time	Sets the rise time (0.1 s to 30.0 s) The soft start function is turned on.	Action to perform when the current limit is exceeded: DISABLE Compensation function: soft sensing or regulation adjustment
OFF (F3)		The soft start function is turned off.	None

Configuring soft stop

Press OTHERS (SHIFT+MEMORY) > 1/2 (F6) > FALL TIM (F1) to configure soft stop.
If you select ON, "FALL TIM" will be displayed.



Parameter	Title	Description	Conditions that are not allowed
ON (F2)	Fall Time	Sets the fall time (0.1 s to 3.0 s) Soft stop on	Action to perform when the current limit is exceeded: DISABLE Compensation function: soft sensing or regulation adjustment
OFF (F3)		Soft stop off	None

Selecting the Response

You can set the response speed of the internal amplifier (to one of the following three levels) according to the load conditions and how you will use the PCR-WE.

You can prevent the output from becoming unstable or from oscillating depending on the load circuits (especially in the case of capacitive loads) and the wiring conditions. The factory default setting is normal speed (MEDIUM).

- High-speed response (FAST)

This is mostly used in research and development, such as in special tests that require fast rise and fall speeds of power supplies. Depending on the load conditions, the output may become unstable (it may oscillate). Check the output voltage waveform before you actually perform the tests. If the output is unstable, set the response to MEDIUM or SLOW.

- Normal speed (MEDIUM)

This is used in power-supply-environment testing to cover a range of frequencies from commercial power line frequencies to the frequencies used by ship and aircraft power supplies.

- High stability (SLOW)

This is used to provide stable power to a variety of loads. For example, this setting would be used on the power supplies at an EMC test sight. Even if a capacitor that has a large capacity (such as a large noise filter) is connected to the output of the PCR-WE, this setting can be used to provide stable operations. This setting provides a sufficient response speed to generate commercial power line frequencies, so it can also be used in typical evaluation tests.

1 Press OTHERS (SHIFT+MEMORY) > 1/2 (F6) > RESP (F3).

2 Sets the response speed you want to use.

Parameter	Title	Description	Conditions that are not allowed
SLOW(F1)	CV Response	Selects the highly stable response speed	Output on
MEDIUM(F2)		Selects the normal speed	Output on Compensation function: regulation adjustment
FAST*1 (F3)		Selects the high-speed response	

*1. Not available during parallel operation

3 Press ENT.

If SLOW is selected, "RESP.S" will be displayed on the panel. If MEDIUM is selected, "RESP.M" will be displayed. If FAST is selected, "RESP.F" will be displayed.

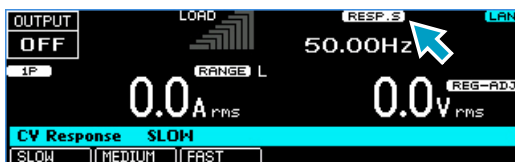

This completes the setting.

Using the Power Management Functions

The PCR-WE has the following two power management functions: a sleep function and a power-saving function

Sleep function

You can set the PCR-WE so that it enters sleep mode after a certain amount of time passes with its power on but no output being generated (the output is off).

When sleep mode is enabled and the specified time elapses, the internal power modules turn off, which reduces power consumption.

During sleep mode, “zzz...zzz...Please push ESC key” is displayed faintly on the screen (it scrolls across the screen).

Press ESC to exit sleep mode. You cannot turn the output on for approximately 1 minute between when sleep mode is exited and the internal power modules turn on (busy status).

If an SCPI command is received or if an alarm or trouble occurs, sleep mode is cleared.

Press SLEEP (SHIFT+1) to set the sleep function.

Parameter	Title	Description
ON(F2)	Sleep Timer	The sleep function turns on. Sets the amount of time that elapses before the product enters sleep mode (1 min to 60 min).
OFF(F3)		The sleep function turns off.
EXEC(F5)	—	Starts sleep mode immediately

Power-saving function

This product consists of power modules that cover the rated output capacity.

If you are using the product at less than the rated output capacity, the product can operate using only the necessary power modules. Even if you are not supplying power to a load, the power modules suffer power loss. Operating the product with the minimum number of power modules reduces power consumption.

With the power-saving function, you set the maximum expected power that will be used. If the specified power capacity is exceeded, the protection functions will be activated.

There is a separate setting for each output method (single-phase output, single-phase three-wire output, three-phase output).

On the PCR1000WE/PCR2000WE/PCR3000WE2, the power-saving function is invalid.

If there are power modules that are paused by the power module management function (p.111), the upper limit of the maximum expected power setting range is changed according to the number of power modules that are running.

The output cannot be turned on (busy status) for about 1 minute after changing the maximum expected power setting.

Press OPR MODE > POW SAV (F4).

Parameter	Title	Description
POW SAV(F4)	Power Save	Sets the maximum expected power (0 kVA to the rated output capacity; resolution: 6 kVA). After setting the value, press APPLY.

To clear the power-saving function, set the MAX setting to the rated output capacity.

Power module management function

This product consists of power modules that cover the rated output capacity.

If you do not want to use a failed power module, you can specify the module by module ID and pause it. You can view failed power modules by pressing ALM CHK (F5) when an alarm (ALM-08-01) is activated.

The output cannot be turned on (busy status) for about 1 minute after changing the setting.

If the maximum expected power value of the power-saving function is less than the maximum power of the running modules, the maximum expected power is displayed.

- 1** Press CONFIG (SHIFT+OPR MODE) > 1/3 (F6) > PU MGMT (F3) > EDIT (F3).
- 2** Use the rotary knob to select the module you want to run or pause.
- 3** To run the module, press ON (F2). To pause the module, press OFF (F3).

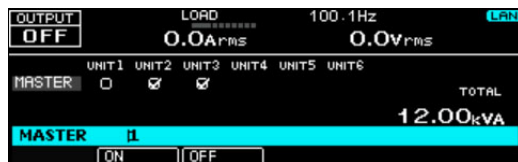

- 4** Press ESC > APPLY (F5).
To cancel the setting, press CANCEL (F5). This completes the setting.

Sequence Function

Sequence Overview

A sequence is a series of settings—values such as the output voltage, frequency, and time—that are saved in advance and are then recalled and automatically carried out in order at a later time.

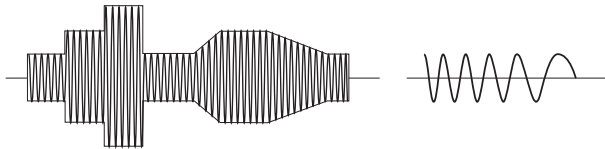

Sequences are groups of executable units called steps. When a sequence is executed (run), its steps are executed in order, starting with the specified starting step. A single execution of a sequence is completed after the sequence's specified last step has been executed.

You can use the jump function to skip steps and repeatedly execute all the steps in the sequence except for those that have been skipped.

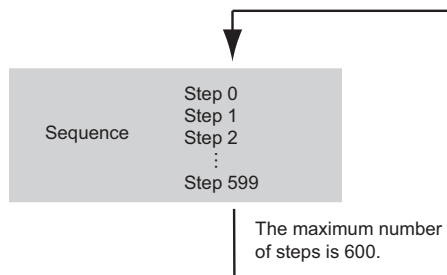

First, set the starting step, and then set the sequence conditions.

When a sequence is completed, the product's settings are those of the last step. If the output is on in the last step of the sequence, the output will remain on when the sequence is completed.

The step editing screen is shown on page 8 (page 9 for single-phase three-wire output and three-phase output). The following table shows the parameters that can be set in each step and on what page it can be set.

Parameter that can be set in a step	Step editing screen
AC voltage	1
AC voltage of each phase	1
AC voltage signal change	1
Frequency	1
Frequency signal change	1
DC voltage	3
DC voltage of each phase	3
DC voltage signal change	3
Output impedance	7, 8 ^{*1}
Step execution time	2
Number of the waveform bank to use	2
Output on/off	3
Status output	4
Trigger output	4
Trigger input	4
Jump function	5
Starting phase angle	6
Ending phase angle	6
Sudden phase change	6
U phase offset	9 ^{*2}
U phase change	9 ^{*2}
UV phase difference	9 ^{*2}
V phase change	9 ^{*2}
UW phase difference	9 ^{*2}
W phase change	9 ^{*2}

*1. Single-phase three-wire output and three-phase output only

*2. Three-phase output only

■ Step's signal change (ramp)

To change (sweep) the frequency or voltage linearly over the specified time, select "RAMP ON." To change the value as a step, select "RAMP OFF."

If you specify "RAMP ON" in step 0, the signal will change linearly from the current voltage or frequency.

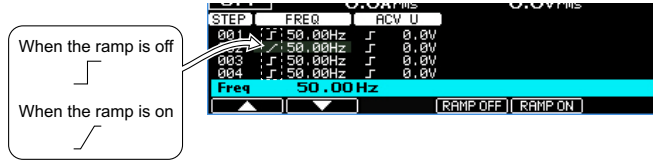

• Voltage signal change

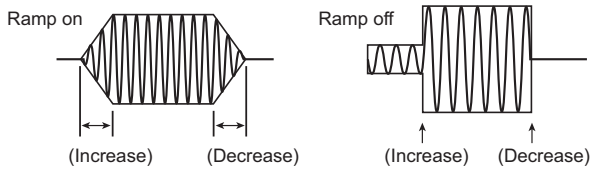

• Frequency signal change

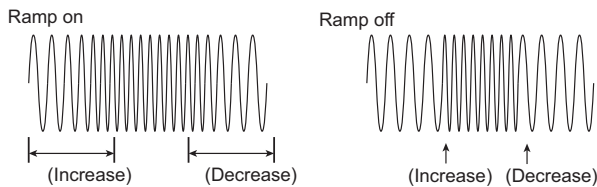

• Phase signal change

For three-phase output, you can set the phase ramp (leading or lagging). This is effective for varying the line voltage.

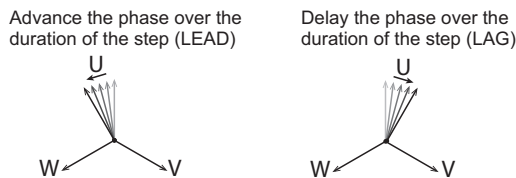

■ Signal output and Resuming

If the status signal is enabled, a status signal will be output while a step is being executed.

If the trigger signal output is enabled, a signal is output for several tens of microseconds when a step is executed.

You can apply a trigger signal to resume a paused sequence.

■ Starting phase angle and ending phase angle

Steps are managed in terms of time.

If you set the starting phase angle, steps will start from the specified phase angle.

Phase wait time is the duration from the point when the step time of the last step has elapsed to the point where the phase angle reaches the starting phase angle. The phase wait time is dependent on frequency.

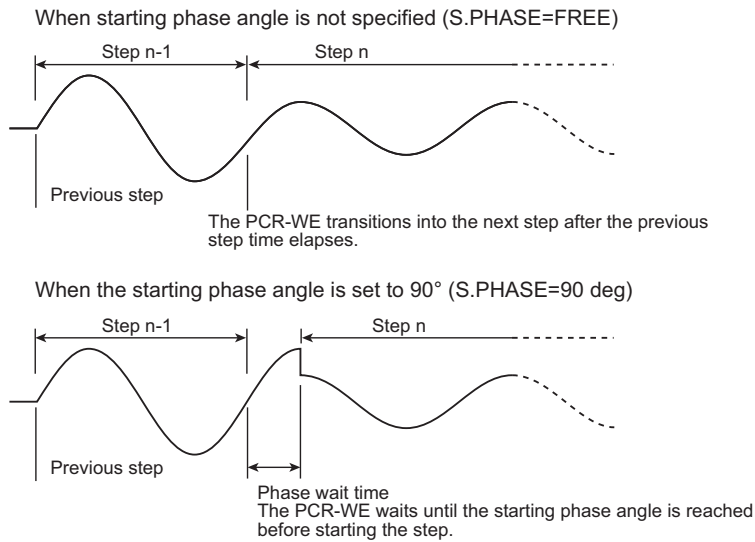

If you set the ending phase angle, the PCR-WE will end the step when the specified phase is reached.

Phase wait time is the duration from the point when the step time has elapsed to the point where the phase angle reaches the ending phase angle. The phase wait time is dependent on frequency.

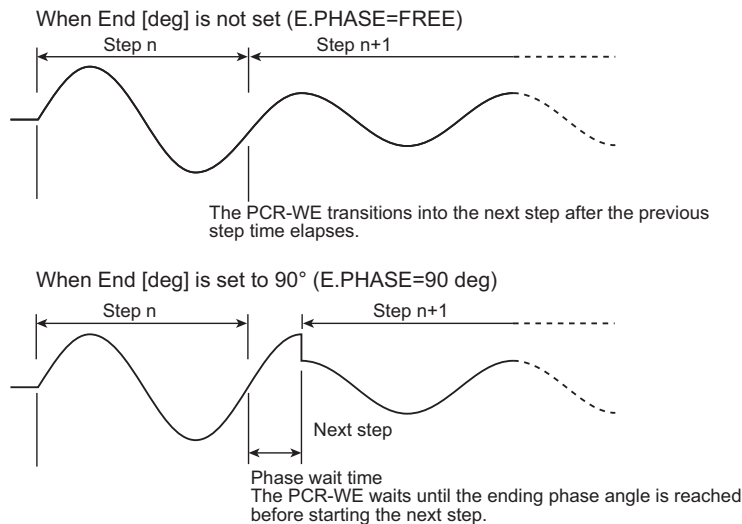

You can output the same waveform regardless of whether you set the starting phase angle or the ending phase angle.

When a waveform is to be output continuously (the phase does not change suddenly) and you set both the starting and ending phase angles, the waveform may be offset by one period. To avoid confusion, we recommend that you set the starting phase angle and not the ending phase angle (FREE).

■ Display and signal output during the phase wait time

During the phase wait time, the screen shows the next step number. The elapsed time remains at zero until the next step starts.

The status signal is output while the waveform of the step that is enabled is being output.

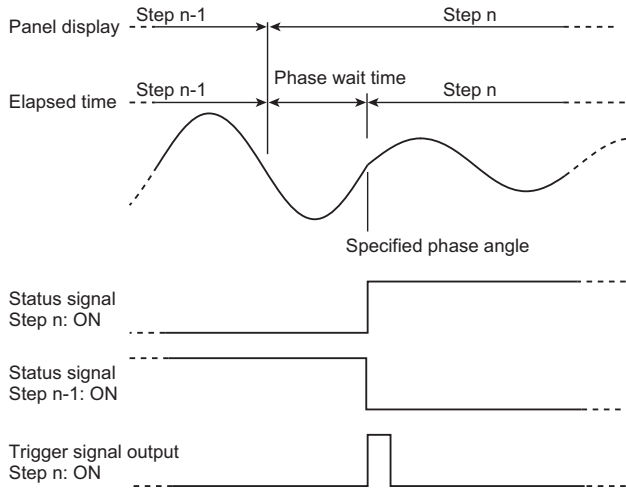

■ Sudden phase change

If you set both the starting and ending phase angles and specify sudden phase change, the phase will suddenly change.

If you set sudden phase change to ON, you can switch between two steps according to the set phase angles. For example, if you set the step n-1's ending phase angle to 90°, the step n's starting phase angle to 270°, and set sudden phase change to ON, when the step time of step n-1 elapses and 90° is reached, a transition is made to step n (270° phase angle).

■ Jump function

The steps in a sequence are normally executed in order starting with the starting step. However, you can use the jump function to skip over steps and repeat sets of steps by repeatedly executing jumps.

Editing Steps

The step editing screen is shown on page 7 (page 9 for single-phase three-wire output and three-phase output).

Press SEQ (SHIFT+SIM) > EDIT (F5) to display the step editing screen.

You cannot edit steps when the sync function is on.

Common items

The step or parameter that you are configuring is indicated with a different background color. First use the rotary knob to specify the step that you want to configure, and then configure its settings.

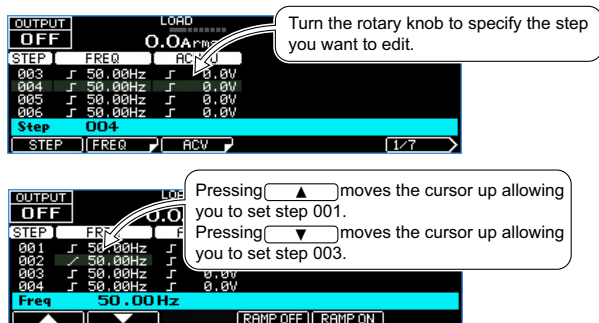

Parameter	Title	Description
STEP(F1)	STEP	Sets the step (0 to 599) that you want to configure
▲ (F1)	—	Sets the previous step as the one that you want to configure
▼ (F2)	—	Sets the next step as the one that you want to configure

[1] Frequency and AC voltage

Use this screen to set the frequency and the AC voltage. The step signal change can also be set for the frequency and the AC voltage.

If the peak AC+DC output voltage exceeds the product's rated output voltage, the output voltage waveform (the peak section) may be distorted (clipped).

If you are setting the phase voltages separately for single-phase three-wire output or three-phase output, press ACV (F3) to first set all the phases at the same time, and then press ACV V (F4) and ACV W (F5) to set the V phase and W phase, respectively. AC voltage signal change applies to all phases.

Parameter	Title	Description
FREQ(F2)	Freq	Set the step frequency
	RAMP OFF(F4)	Disables the ramped frequency signal change
	RAMP ON(F5)	Enables the ramped frequency signal change
ACV(F3) ^{*1}	ACVolt	Sets the AC voltage of the step
	AC PhaseVolt ^{*2}	Disables the ramped AC voltage signal change
		Enables the ramped AC voltage signal change
ACV V(F4) ^{*2}	AC V PhaseVolt	Sets the AC voltage of the step (V phase)
	RAMP OFF(F4) ^{*3}	Disables the ramped AC voltage signal change
	RAMP ON(F5) ^{*3}	Enables the ramped AC voltage signal change
ACV W(F5) ^{*4}	AC W PhaseVolt	Sets the AC voltage of the step (W phase)
	RAMP OFF(F4) ^{*3}	Disables the ramped AC voltage signal change
	RAMP ON(F5) ^{*3}	Enables the ramped AC voltage signal change

*1. For single-phase three-wire output and three-phase output, set the phase voltage of all phases at once.

*2. For single-phase three-wire output and three-phase output

*3. This is shared between all phases. You cannot set it for each phase.

*4. Three-phase output

[2] Execution time, waveform bank

Use this screen to set the step execution time, the waveform bank, and the output.

If you are setting the waveform bank to use for each phase for three-phase output, press WB NO (F3) to first set all the phases at the same time, and then press V WB NO (F4) or W WB NO (F5) to set the V phase and W phase, respectively.

Parameter		Title	Description
TIME(F2)	HOUR(F2)	Time(HOUR)	Sets the step time's hours (0 hours to 1 000 hours)
	MIN(F3)	Time(MIN)	Sets the step time's minutes (0 minutes to 59 minutes)
	SEC(F4)	Time(SEC)	Sets the step time's seconds (0 seconds to 59 seconds)
	100US(F5)	Time(100us)	Sets the step time's microseconds in units of 100 μ s (0 μ s to 999 900 μ s)
WB NO(F3)		WB No.	Sets the waveform bank number to use
V WB NO(F4) ^{*1}		V WB No.	Sets the waveform bank number to use for the V phase.
W WB NO(F5) ^{*1}		W WB No.	Sets the waveform bank number to use for the W phase.

*1. For three-phase output

[3] DC voltage, output

Use this screen to set the DC voltage. The step signal change can also be set for the DC voltage.

If the peak AC+DC output voltage exceeds the product's rated output voltage, the output voltage waveform (the peak section) may be distorted (clipped).

If you are setting the voltage of each phase separately for three-phase output, press DCV (F3) to first set all the phases at the same time, and then press DCV V (F4) and DCV W (F5) to set the V phase and W phase, respectively. DC voltage signal change applies to all phases.

Parameter	Title	Description
OUTPUT(F2)	OFF(F4)	Output
	ON(F5)	
DCV(F3) ^{*1}	DCVolt	DC Voltage
	RAMP OFF(F4)	DC PhaseVolt ^{*2}
	RAMP ON(F5)	
DCV V(F4) ^{*2}	DC V PhaseVolt	DC Voltage
	RAMP OFF(F4) ^{*3}	
	RAMP ON(F5) ^{*3}	
DCV W(F5) ^{*4}	DC W PhaseVolt	DC Voltage
	RAMP OFF(F4) ^{*3}	
	RAMP ON(F5) ^{*3}	

*1. For single-phase three-wire output, set the U phase voltage (the V phase will automatically be set to the negative value of the U phase).
For three-phase output, set the phase voltage of all phases at once.

*2. For single-phase three-wire output and three-phase output

*3. This is applies to all phases. You cannot set it separately for each phase.

*4. Three-phase output

[4] Status output, trigger output, trigger input (pause)



Risk of electric shock. Use the DIGITAL I/O connector with an isolation voltage of 42 Vpeak or less.

Use this screen to set the status signal output, trigger signal output, and trigger signal input wait. Set the signal polarity with the external control function.

Parameter		Title	Description
STAT.OUT(F2)	OFF(F4)	Status Out	Sets the status signal output to off
	ON(F5)		Sets the status signal output to on
TRIG.OUT(F3)	OFF(F4)	Trig Out	Set the trigger signal output to off
	ON(F5)		Set the trigger signal output to on
TRIG.IN*1 (F4)	OFF(F4)	Trig In	Disables trigger signal input wait
	ON(F5)		Enables trigger signal input wait (pause)

*1. In the same step, do not turn on both the trigger input setting and the sudden phase change setting (PHAS.CHG). If you do, the sequence cannot be executed.

The DIGITAL I/O connector is isolated from the product's INPUT and OUTPUT terminal blocks. The common line of the TRIG and STAT signals is shared internally, so it is not isolated from the DIGITAL I/O connector.

If the signal line that is connected to the connector has an electrical potential compared to ground, the connected device or the product may be damaged when a current flows through the signal line.

- Status signal output (STAT.OUT)

When the status signal output is turned on, the signal is output only while the step's waveform is being output.

Use monitoring ([p. 171](#)) or selectable I/O ([p. 174](#)) to map the status output (SEQ Status Out) to a channel.

- Trigger signal output (TRIG.OUT)

When the trigger signal output is turned on, the signal is output for several tens of microseconds when a step is executed.

Use selectable I/O ([p. 174](#)) to map the trigger output (SEQ Trigger Out) to a channel.

There is a time difference of approximately 100 μ s between the trigger signal output and changes to the actual output.

Trigger input (TRIG.IN)

When the trigger input is turned on, the sequence is paused after the previous step is finished, and the product enters a trigger input wait state. If a trigger signal (pulse width of at least 10 μ s) is received through the DIGITAL I/O terminal, the paused is released, and the step is executed.

Use selectable I/O ([p. 174](#)) to map the trigger input (SEQ Trigger In) to a channel.

During the trigger input wait time, the screen shows the next step. The elapsed time remains at zero until the next step starts.

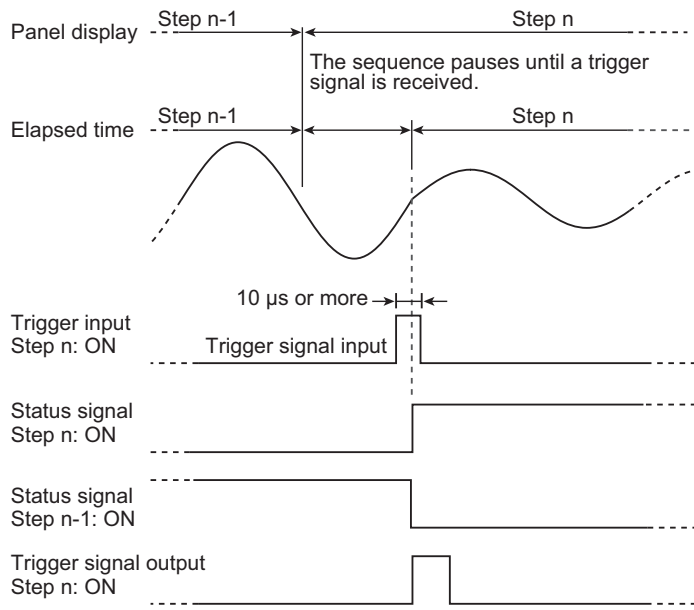

[5] Jump function

Use this screen to set whether to skip over steps or repeat steps.

Parameter	Title	Description
TYPE(F2)	NORM(F4)	Step Type
	JUMP(F5)	
JUMP STEP(F3)	Jump Step	After this step is completed, the subsequent step will be executed. After this step is completed, the specified step will be executed.
JUMP CNT(F4)	Jump Count	Sets the jump destination step (0 to 599) Sets the number of jump repetitions (1 to 99 999; 99 999 indicates unlimited repetitions)

Jump function

The steps in a sequence are normally executed in order starting with the starting step. However, you can use the jump function to skip over steps and repeat sets of steps by repeatedly executing jumps.

- Example of not using the jump function

If you set TYPE to NORM, both JUMP STEP and JUMP CNT will be disabled.

Step	TYPE	JUMP STEP	JUMP CNT
0 to 7	NORM	0	1

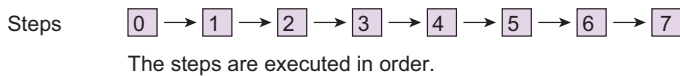

- Example of using the jump function (skipping steps)

Step	TYPE	JUMP STEP	JUMP CNT
0, 1, 3 to 7	NORM	0	1
2	JUMP	5	1

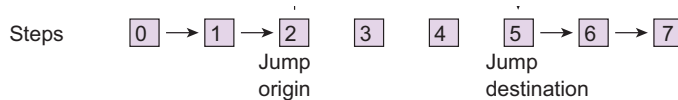

The execution jumps over steps 3 and 4.

The step execution order is 0→1→2→5→6→7.

- Example of using the jump function (repeating steps)

Step	TYPE	JUMP STEP	JUMP CNT
0 to 4, 6, 7	NORM	0	1
5	JUMP	2	2

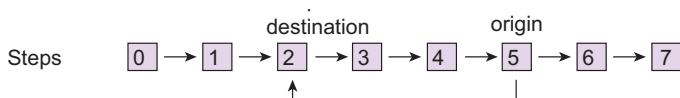

The execution jumps from step 5 to step 2.

Order of step execution:

0→1→2→3→4→5→2→3→4→5→2→3→4→5→2→3→4→5→6→7

[6] Starting phase angle, ending phase angle, sudden phase change

Use this screen to set the starting phase angle, ending phase angle, and sudden phase change.

Parameter	Title	Description
S.PHASE(F2)	FREE(F5)	Start Phase
	FIXED(F4)	Does not set the starting phase angle
E.PHASE(F3)	FREE(F5)	End Phase
	FIXED(F4)	Sets the starting phase angle (0.0 deg to 360.0 deg, 0=360)
PHAS. CHG*1 (F4)	OFF(F4)	Phase Change
	ON(F5)	Disables sudden phase change
		Enables sudden phase change

*1. In the same step, do not turn on both the sudden phase change setting and the trigger wait setting (TRIG.IN). If you do, the sequence cannot be executed.

NOTE

Setup example for making sudden phase changes

First, set the ending phase angle of the step immediately before the sudden phase change to 90°. If the sudden phase change is set to off, the sequence moves to the next step when the phase angle reaches 90° after the step time of the previous step elapses, as shown below.

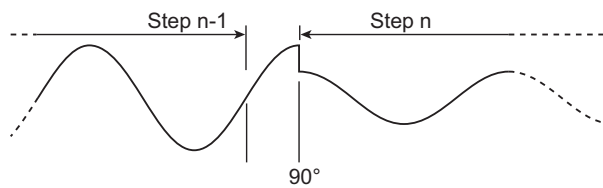

Next, set the starting phase angle of the step in which you want to perform the sudden phase change to 270°. Even when the phase angle reaches 90° after the step time of the previous step elapses, the sequence does not move to the next step. The sequence moves to the next step when the phase angle reaches 270°.

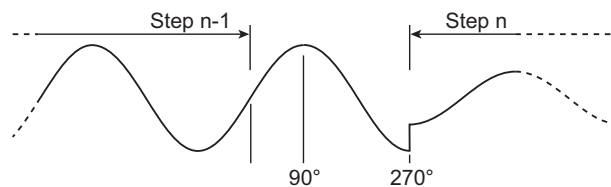

Lastly, set the sudden phase change to on. When the phase angle of the previous step reaches 90°, the sequence changes to the next step. The next step begins at 270°.

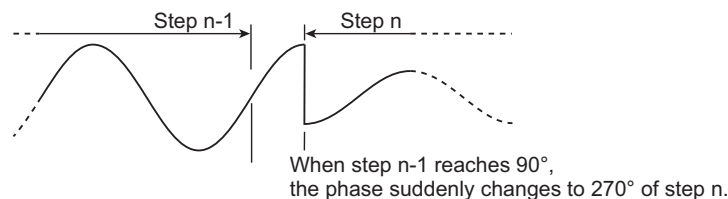

[7] Output impedance (for single-phase output)

Use this screen to set the output impedance.

Parameter	Title	Description
OUT IMP.(F2)	OFF(F4)	Out Z Disables the output impedance
	ON(F5)	Enables the output impedance
RESIST(F3)	Resistance	Sets the output impedance (resistance component).
REACT(F4)	Reactive	Sets the output impedance (reactance component).

[7] Output impedance (for single-phase three-wire output and three-phase output, resistance component)

Use this screen to set the output impedances (resistance component).

If you are setting the output impedances separately, press RESIST (F3) to first set all the phases at the same time, and then press RESIST V (F4) and RESIST V (F5) to set the V phase and W phase, respectively.

Parameter	Title	Description
OUT IMP.(F2)	OFF(F4)	Out Z Disables the output impedance
	ON(F5)	Enables the output impedance
RESIST(F3)	Resistance	Sets the output impedance (resistance component).
RESIST V(F4)	V Resistance	Sets the output impedance (resistance component) of the V phase.
RESIST W(F5)*1	W Resistance	Sets the output impedance (resistance component) of the W phase.

*1. Three-phase output

[8] Output impedance (for single-phase three-wire output and three-phase output, reactance component)

Use this screen to set the output impedances (reactance component).

If you are setting the output impedances separately, press REACT (F3) to first set all the phases at the same time, and then press REACT V (F4) and REACT V (F5) to set the V phase and W phase, respectively.

Parameter	Title	Description
OUT IMP.(F2)	OFF(F4)	Out Z Disables the output impedance
	ON(F5)	Enables the output impedance
REACT(F3)	Reactive	Sets the output impedance (reactance component).
REACT V(F4)	V Reactive	Sets the output impedance (reactance component) of the V phase.
REACT W(F5)*1	W Reactive	Sets the output impedance (reactance component) of the W phase.

*1. Three-phase output

[9] Phase difference for three-phase output

Use this screen to set the U-phase offset phase angle and the phase differences of the V phase and W phase relative to the U phase. Also set the step's signal change.

Set this when only one or two phases are to change suddenly or when performing a phase sweep.

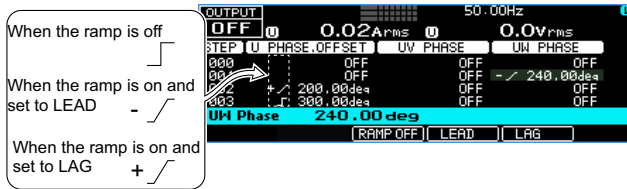

Parameter	Title	Description
U PHA.OFFS(F2)	RAMP(F3) ^{*1}	Disables the ramped U phase change (sudden phase change)
	LEAD(F4)	Sets the U phase change to leading (phase sweep)
	LAG(F5)	Sets the U phase change to lagging (phase sweep)
	OFF(F4)	Disables the U phase offset.
	ON(F5)	Sets the U phase offset (0.00 deg to 360.00 deg) 0=360
UV PHASE(F3)	RAMP(F3) ^{*1}	Disables the ramped V phase change (sudden phase change)
	LEAD(F4)	Sets the V phase change to leading (phase sweep)
	LAG(F5)	Sets the V phase change to lagging (phase sweep)
	OFF(F4)	Disables the U-V phase difference setting. The phase will not change from the previous step.
	ON(F5)	Sets the U-V phase difference (0 deg to 360 deg) Resolution: 0.1 (0.01 when the waveform bank is 0)
UW PHASE(F4)	RAMP(F3) ^{*1}	Disables the ramped W phase change (sudden phase change)
	LEAD(F4)	Sets the W phase change to leading (phase sweep)
	LAG(F5)	Sets the W phase change to lagging (phase sweep)
	OFF(F4)	The phase difference between U and W is not set. The phase will not change from the previous step.
	ON(F5)	The phase difference between U and W (0 deg to 360 deg) is set. Resolution: 0.1 (0.01 when the waveform bank is 0)

*1. When ON (F5) is selected

■ **U phase offset setting.**

If you set the U phase offset, the U phase will be offset from the reference phase. As a result, the U-V/U-W phase difference settings will be offset from the actual phase difference.

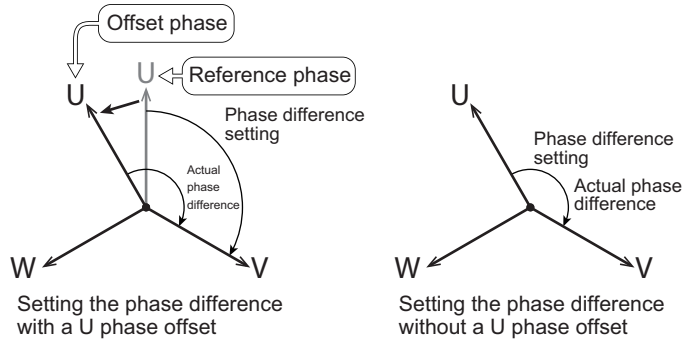

To avoid confusion, we recommend that you turn off the U phase offset when you use the phase sweep feature. For details, see "Phase setting for multi-phase output" (p.143) in the sequence tutorial.

■ **Ramp setting**

Phase ramp can be set to leading (LEAD) or lagging (LAG). This is effective for varying the line voltage.

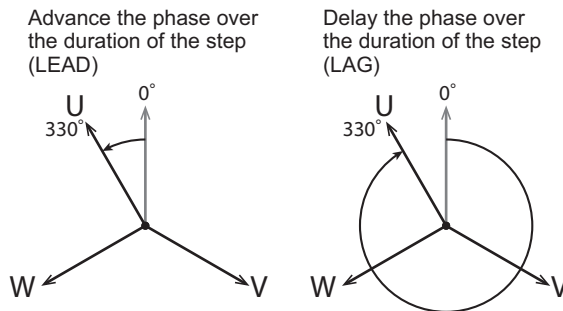

Set an absolute angle for the phase angle.

For details, see "Phase sweep" in the sequence tutorial (p.147).

Setting Sequence Conditions

The items that you set here are shared between all steps.

■ Setting the starting step number and the ending step number

On the sequence screen, press COND (F4) to set the starting step number and the ending step number (starting step number < ending step number).

Parameter	Title	Description
START STEP	Start Step	Sets the starting step number (0 to 599)
END STEP	End Step	Sets the ending step number (0 to 599)

■ Setting the number of repetitions

On the sequence screen, press LOOP (F3) to set the number of times that the sequence will be repeated.

Parameter	Title	Description
LOOP(F3)	Loop	Sets the number of repetitions (1 to 99 999; 99 999 indicates unlimited repetitions)

■ Setting the control logic of the trigger and status output

To use status output, you need to map the status signal output to the DIGITAL I/O terminal. For details, see “Monitoring the operation status” ([p.171](#)) or “Selectable I/O” ([p.174](#)).

To use triggers, you need to map the trigger I/O to the DIGITAL I/O terminal. For details, see “Selectable I/O” ([p.174](#)).

Executing, Pausing, and Stopping Sequences

After you have finished setting the steps and the sequence conditions, you can execute the sequence.

Press SEQ (SHIFT + SIM) > RUN (F1) to run the sequence.

You cannot run a sequence in the following situations.

- The voltage range is set to the L range and there is a step whose voltage exceeds the output voltage setting range (switch the range to the H range, or set the output voltage so that it is within the L range).
- The regulation adjustment or soft sensing compensation function is in use.
- The voltage or frequency is set to a value outside the corresponding limits.
- There is a step where the trigger wait setting (TRIG.IN) and the sudden phase change setting (PHAS.CHG) are both turned on.
- The output impedance setting is out of range.
- The external analog input function (VPROG) is in use.
- The external analog input function (EXTDC) is in use, and the signal source is EXT.
- The sync function is running.
- Soft start or soft stop is in progress.
- Power line abnormality simulation is in progress.

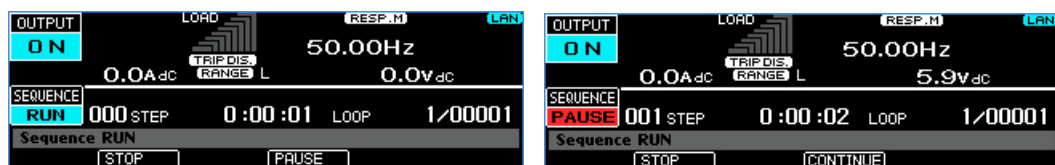

Parameter	Title	Description
STOP(F2)	Sequence	Stops the running sequence (the output remains in the state of step being run).
PAUSE(F4)		Pauses a sequence that is being executed
CONTINUE(F4)		Resumes a sequence that has been paused

You can also resume the execution of a paused sequence by applying a trigger signal.

Press OUTPUT while a sequence is running stops the sequence with the output turned off.

A sequence is complete when all steps are complete. When a sequence is completed, the product's settings are those of the last step.

If the output is on in the last step of the sequence, the output will remain on when the sequence is completed.

If the U phase is offset in the last step of the sequence, the offset (the U PH OFS icon) will remain even when the sequence is complete. Be sure to press 1/2 > U PHASE on the sequence screen to clear the offset. The icon will disappear when you clear the offset.

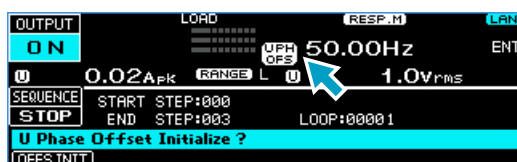

Sequence Creation Tutorial

The following information will be explained.

- Sequence creation basics (p.132)

Describes basic sequence settings (voltage, frequency, and ramp).

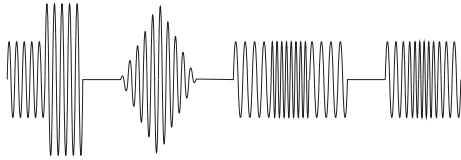

- Voltage sweep and frequency sweep (p.135)

Describes how to sweep a waveform using the ramp function.



- Switching steps at specific phase angles (p.137)

Describes how to start subsequent steps from specified angles after previous steps are completed. The phase is continuous.



- Suddenly changing the phase (p.140)

Describes how to suddenly change the phase between steps.

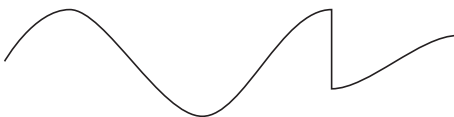

- Single-phase three-wire output and three-phase output basics (p.142)

Describes the waveforms that are produced for single-phase three-wire output and three-phase output.

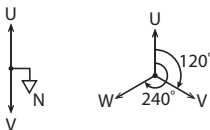

- Phase setting for multi-phase output (p.143)

Describes how to set a sequence so that the phase suddenly changes for multi-phase output.



- Phase sweep ([p. 147](#))

Describes how to set a sequence so that the phase is swept for multi-phase output.

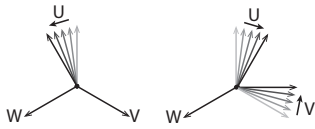

- Line voltage dip ([p. 149](#))

Describes how to set a line voltage dip.

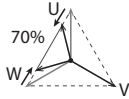

Sequence creation basics

This section explains how to use a sequence to output the following waveform.

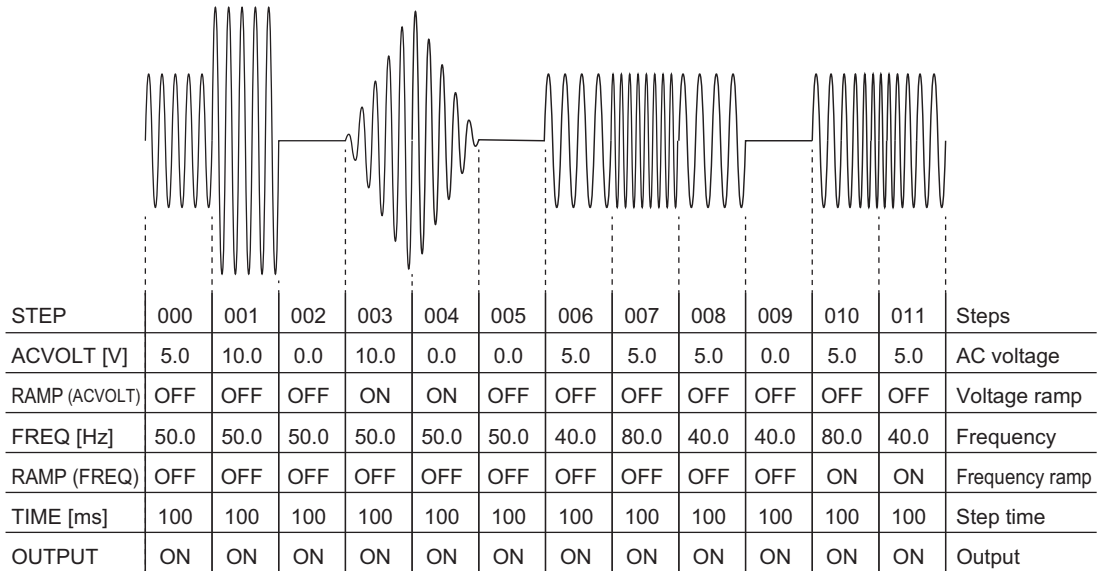

In this example, use default values for items that are not specified.

■ Setting Procedure

Use the rotary knob or the numeric keypad enter values for items that you want to set. When using the numeric keypad, press ENT after you enter values.

Press SEQ (SHIFT+SIM) to display the sequence screen. Press EDIT (F5) to display the step editing screen.

You can edit the step with a parameter or value with a colored background.

At first, step 000 is selected. If 000 is not selected, use the rotary knob to select it. You can also select steps by pressing STEP (F1) and then using the rotary knob.

Set the AC voltage. Press AC VOLT (F3).

A border is displayed around the ACV item of step 000. Use the rotary knob to specify 5.0 V.

Press ▼ to move the cursor to the voltage of step 001. Then, use the rotary knob to specify 10.0 V.

The default AC voltage is 0.0 V. The voltage of step 002 is 0.0 V (if it is not, set it to 0.0 V), so press twice to move the cursor to the voltage of step 003.

In step 003, the voltage changes from 0.0 V to 10.0 V over 100 ms. This is because the voltage ramp setting is on. Use the rotary knob to set the voltage to 10.0 V, and then press RAMP ON (F5). The voltage ramp indication changes to .

In step 004, the voltage changes from 10.0 V to 0.0 V over 100 ms. Set the voltage of step 004 to 0 V, and set the voltage ramp to on.

Set the voltages of steps 006 to 008 and steps 010 and 011 to 5.0 V. This completes the voltage settings.

Press ESC to return to the previous screen. Press FREQ (F2) to set the frequency.

The default frequency is 50.0 Hz. Press ▲ repeatedly until you reach the frequency of step 006. (If steps 001 to 005 are not set to 50.0 Hz, start by setting the frequencies from step 001.) Then, use the rotary knob to specify 40.0 Hz.

Press ▼ to move the cursor to the frequency of step 007. Then, use the rotary knob to specify 80.0 Hz. Likewise, set steps 008 and 009 to 40 Hz. Then, press ▼ to move the cursor to the frequency of step 010.

In step 010, the frequency changes from 40 Hz to 80 Hz over 100 ms. This is because the frequency ramp setting is on. Use the rotary knob to set the frequency to 40 Hz, and then press RAMP ON (F5). The frequency ramp indication changes to .

In step 011, the frequency changes from 80 Hz to 40 Hz over 100 ms. Set the frequency of step 011 to 40 Hz, and set the frequency ramp to on. This completes the frequency settings.

Press ESC to return to the previous screen. Press 1/5(F6) to move to the next step editing screen.

Press TIME (F2) to set the step execution time. Press ▲ repeatedly until you reach the time setting of step 000. Press 100US (F6), use the numeric keys to enter 1000 (0:00:00.1000), and press ENT. The microsecond resolution is 100 μs.

The minimum step execution time that you can set is 100 μs. Do not set the step execution time to 0 s.

For steps 001 to 011, set the step execution time to 100 ms.

Press ESC to return to the previous screen. The default output setting is on, so there is no need to change it. If it is not on, press OUTPUT (F5). The default settings will be used for the rest of the items. This completes the step settings. If steps 000 to 011 are not set to their default values, set them to default values.

- Default values of other items

Parameter	PCR-WE/ WE2	Sequence setup screen
DCV (DC voltage)	0.0 V, RAMP OFF	3
TYPE (jump type)	NORM	4
JUMP STEP (jump destination step)	0	4
JUMP CNT (number of jump repetitions)	1	4
OUT IMP. (output impedance)	OFF	5
WB NO (waveform bank number)	0	2
STAT.OUT (status output)	OFF	3
TRIG.OUT (trigger output)	OFF	3
TRIG.IN (trigger input)	OFF	3
S.PHASE (starting phase)	FREE	5
E.PHASE (ending phase)	FREE	5
PHAS.CHG (sudden phase change)	OFF	5

Next, set the sequence conditions.

Press ESC repeatedly until the sequence screen appears. Press COND (F4) to set the starting step number and the ending step number.

The highlighted parameter is what you are setting.

The default starting step number is 000. If START STEP is not 000, use the rotary knob to set it to 000.

Press ▼ to move the cursor to END STEP. The ending step is 011, so use the rotary knob to specify 011.

This completes the sequence settings. Let's run the sequence.

Press ESC to display the sequence screen.

Press RUN (F1) to run the sequence. You cannot execute the sequence in the following conditions.

- The voltage range is set to the L range and there is a step whose voltage exceeds the output voltage setting range (switch the range to the H range, or set the output voltage so that it is within the L range).
- The regulation adjustment or soft sensing compensation function is in use.
- The voltage or frequency is set to a value outside the corresponding limits.
- There is a step where the trigger wait setting (TRIG.IN) and the sudden phase change setting (PHAS.CHG) are both turned on.
- The output impedance setting is out of range.

- The external analog input function (VPROG) is in use.
- The external analog input function (EXTDC) is in use, and the signal source is EXT.
- The sync function is running.
- Soft start or soft stop is in progress.
- Power line abnormality simulation is in progress.

The minimum unit for displaying step execution times is seconds. Steps whose execution time is less than 1 second are displayed as "0:00:00."

A sequence is complete when all steps are complete. When a sequence is completed, the product's settings are those of the last step.

If the output is on in the last step of the sequence, the output will remain on when the sequence is completed.

When you have finished setting the sequence, we recommend that you save the settings to a USB memory device.

Connect a USB memory device to the USB port on the front panel. Press OTHERS (SHIFT+MEMORY) > 1/2(F6) > FILE(F5) > SAVE(F3) > SEQ. The name of the file that the sequence will be saved to is displayed in the entry area.

Press SAVE (F4) to save the settings. When the message "File was saved" disappears, remove the USB memory device from the USB port.

Voltage sweep and frequency sweep

This section describes a sequence for outputting a continuous waveform that linearly changes from 0 V to 10 V.

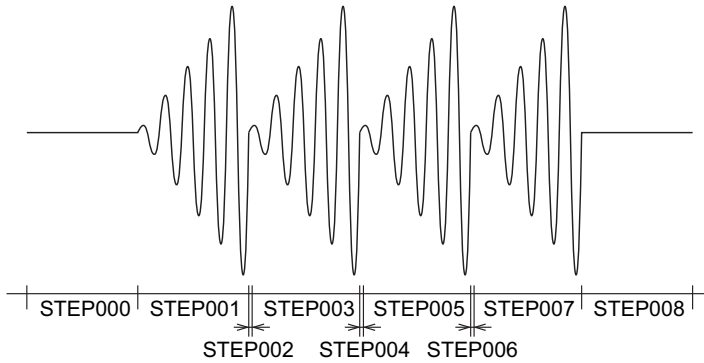

Step	000	001	002	003	004	005	006	007	008
ACVOLT [V] AC voltage	0.0	10.0	0.0	10.0	0.0	10.0	0.0	10.0	0.0
RAMP (ACVOLT) Voltage ramp	OFF	ON	OFF	ON	OFF	ON	OFF	ON	OFF
FREQ [Hz] Frequency	50.0	50.0	50.0	50.0	50.0	50.0	50.0	50.0	50.0
RAMP (FREQ) Frequency ramp	OFF	OFF	OFF	OFF	OFF	OFF	OFF	OFF	OFF
TIME [ms] Step time	100	100	1	100	1	100	1	100	100
OUTPUT Output	ON	ON	ON	ON	ON	ON	ON	ON	ON

In a step whose ramp is set to on, the voltage changes linearly from the voltage setting of the previous step to the specified voltage.

Because we want to change the voltage from 0 V to 10 V, the step before the step that will be set to 10 V must be set to 0 V. For this purpose, we will set short starting voltage steps before steps that will be set to 10 V. In this example, steps 002, 004, and 006 are the starting voltage steps. The minimum step execution time that you can set is 100 μ s. Do not set the step execution time to 0 s.

If you create a sequence without starting voltage steps, the waveform shown below will be output. Because the voltage setting of step 002 is the same as the previous step (10 V), a ramp waveform will not be produced.

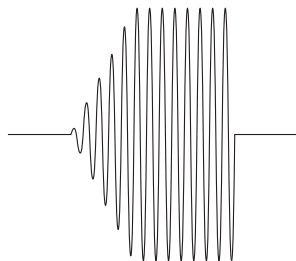

Step	000	001	002	003
ACVOLT [V] AC voltage	0.0	10.0	10.0	0.0
RAMP (ACVOLT) Voltage ramp	OFF	ON	ON	OFF

For the procedure to set steps on this product, see “Sequence creation basics” (p.132).

Likewise, frequency sweeps also need starting frequency steps.

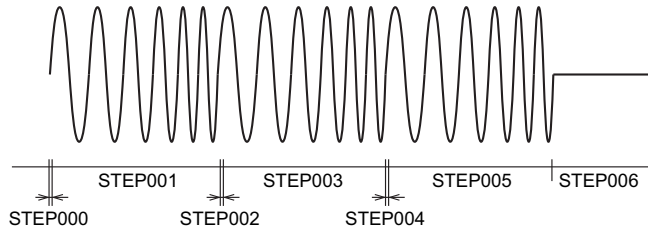

Step	000	001	002	003	004	005	006
ACVOLT [V] AC voltage	0.0	10.0	10.0	10.0	10.0	10.0	0.0
RAMP (ACVOLT) Voltage ramp	OFF	OFF	OFF	OFF	OFF	OFF	OFF
FREQ [Hz] Frequency	40.0	80.0	40.0	80.0	40.0	80.0	40.0
RAMP (FREQ) Frequency ramp	OFF	ON	OFF	ON	OFF	ON	OFF
TIME [ms] Step time	1	100	1	100	1	100	100
OUTPUT Output	ON	ON	ON	ON	ON	ON	ON

Here, steps 000, 002, and 004 are the starting frequency steps.

Switching steps at specific phase angles

This section explains how to switch steps at specific phase angles to produce a continuous waveform. Steps are managed in terms of time. If the starting phase angle and ending phase angle are set to FREE (default setting), the next step will start when the step time elapses. The phase is continuous.

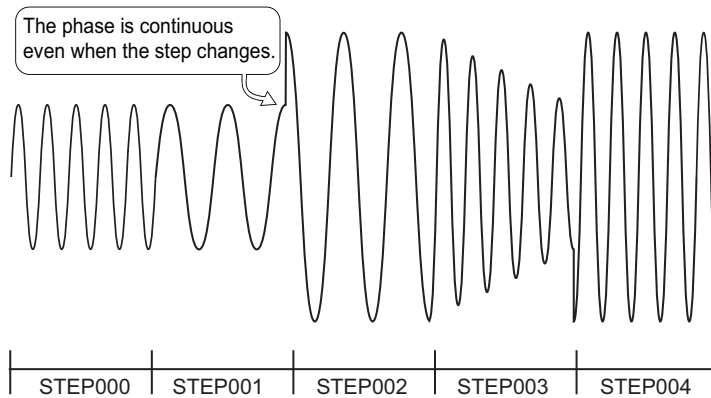

Step	000	001	002	003	004
ACVOLT [V] AC voltage	5.0	5.0	10.0	5.0	10.0
RAMP (ACVOLT) Voltage ramp	OFF	OFF	OFF	ON	OFF
FREQ [Hz] Frequency	50.0	25.0	25.0	50.0	50.0
TIME [ms] Step time	100	90	100	100	100
OUTPUT Output	ON	ON	ON	ON	ON
S.PHASE [deg] Starting phase angle	0	FREE	FREE	FREE	FREE

In this example, step 001 ends at 90°, so step 002 begins at 90°. Now, we change the starting phase angle so that steps 002 and 003 begin at 0°, and step 004 begins at 270°.

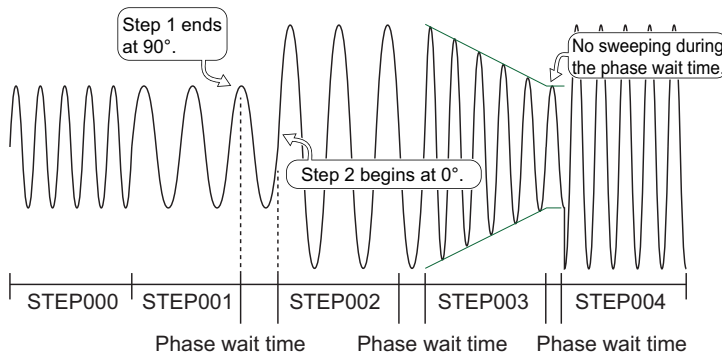

Step	000	001	002	003	004
ACVOLT [V] AC voltage	5.0	5.0	10.0	5.0	10.0
RAMP (ACVOLT) Ramp	OFF	OFF	OFF	ON	OFF
FREQ [Hz] Frequency	50.0	25.0	25.0	50.0	50.0
TIME [ms] Step time	100	90	100	100	100
S.PHASE [deg] Starting phase angle	0	FREE	0	0	270

The phase angle of step 001 when its step time elapses is 90°. Because the starting phase angle of step 002 is 0°, the PCR-WE waits until the phase angle of step 001 becomes 0° before executing step 002. This duration is the phase wait time. When the phase angle of step 001 reaches 0°, step 002 begins. The PCR-WE does not sweep during the phase wait time.

If you set the starting phase angle, the time to run the entire sequence is extended by the phase wait time. The phase wait time depends on the specified frequency.

During the phase wait time, the panel shows the next step number.

The status signal is output while the waveform of the step with STAT.OUT set to ON is being output.

The trigger signal is produced when the step begins.

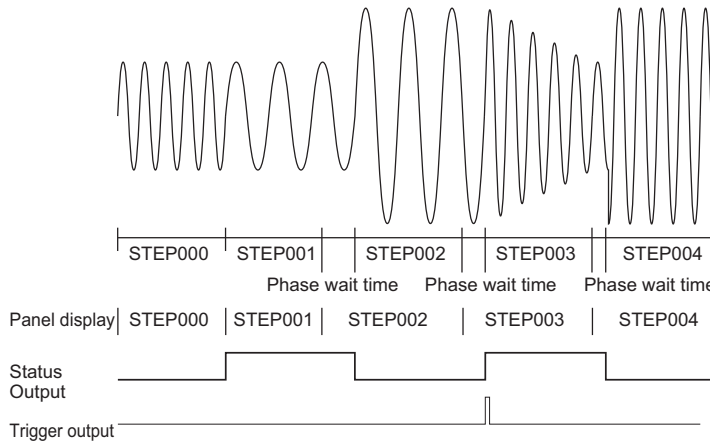

Step	000	001	002	003	004
FREQ [Hz] Frequency	50.0	25.0	25.0	50.0	50.0
S.PHASE [deg] Starting phase angle	0	FREE	0	0	270
STAT.OUT Status output	OFF	ON	OFF	ON	OFF
TRIG.OUT Trigger output	OFF	OFF	OFF	ON	OFF

You can also set the starting phase angle to FREE and the ending phase angle to a specific angle to product the same effect, but to avoid confusion, we recommend that you set the starting phase angle to a specific angle and the ending angle to FREE.

To output a waveform with continuous phase, be sure to set either the starting or ending phase angle to FREE. If you set both the starting and ending phase angles, the waveform may be offset by one period.

In this example, the starting phase angle of step 001 is FREE, so there is no phase wait time. Theoretically, there should not be any phase wait time if the starting phase angle is set to 0°, but depending on the conditions, the waveform may be offset by one period. If the time and phase angle are matched, we recommend that you use FREE. However, if you want to output an waveform accurately according to calculations, you need to shorten the previous step a little (1 ms in this example).

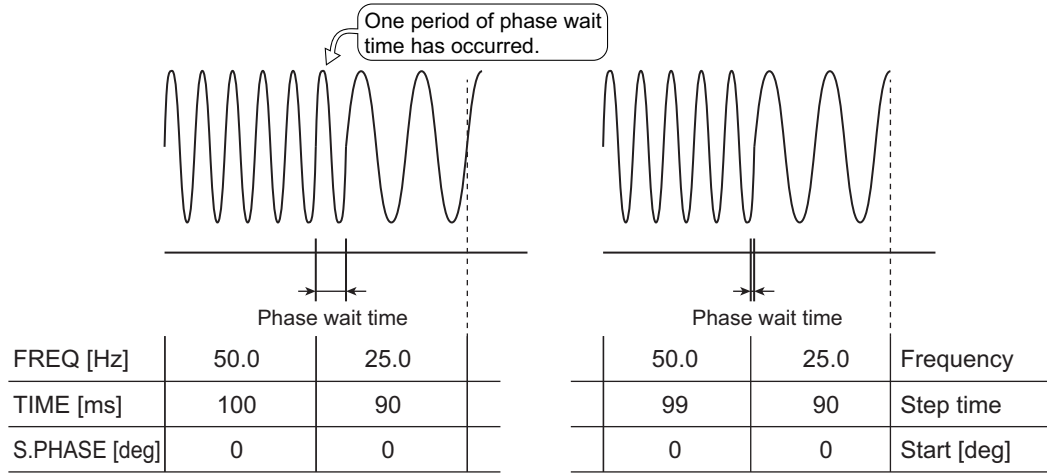

Suddenly changing the phase

To suddenly change the phase, specify a sudden phase change after setting the starting and ending phase angles.

This section explains an example of how to suddenly change the phase from 90° to 270° when the step changes from 002 to 003.

Because step 002 is set to 100 ms and 25 Hz, the phase angle will end at 180° if the ending phase angle is not specified (FREE). Because we want the phase to suddenly change from 90° to 270° between steps 002 and 003, we set the ending phase angle of step 002 to 90°. Step 003 will not begin until the phase angle changes from 180° to 90°, so there will be a phase wait time.

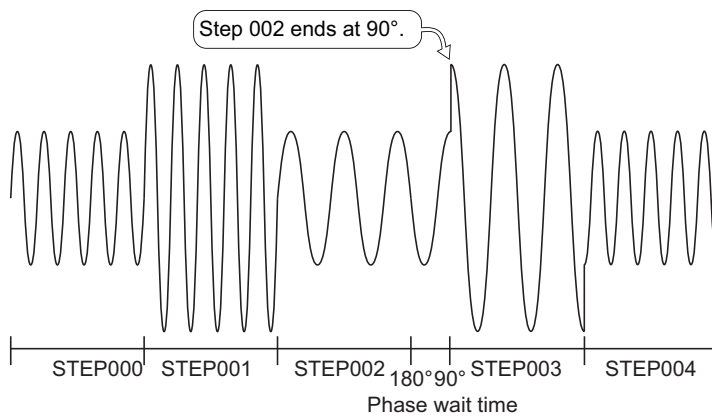

Step	000	001	002	003	004
ACVOLT [V] AC voltage	5.0	10.0	5.0	10.0	5.0
FREQ [Hz] Frequency	50.0	50.0	25.0	25.0	50.0
TIME [ms] Step time	100	100	100	100	100
OUTPUT Output	ON	ON	ON	ON	ON
S.PHASE [deg] Starting phase angle	0	FREE	FREE	FREE	FREE
E.PHASE [deg] Ending phase angle	FREE	FREE	90	FREE	FREE
PHAS.CHG Sudden phase change	OFF	OFF	OFF	OFF	OFF

We want the phase to suddenly change to 270° in step 003, so we set the starting phase angle of step 003 to 270° and set the sudden phase change function to on. Step 002 will end at 90°, and step 003 will begin immediately from 270°.

To use sudden phase change, be sure to set the ending phase angle of the previous step and the starting phase angle of the step in which you want the phase to suddenly change. If you specify sudden phase change with either phase angle set to FREE, the phase will not change with the correct angles.

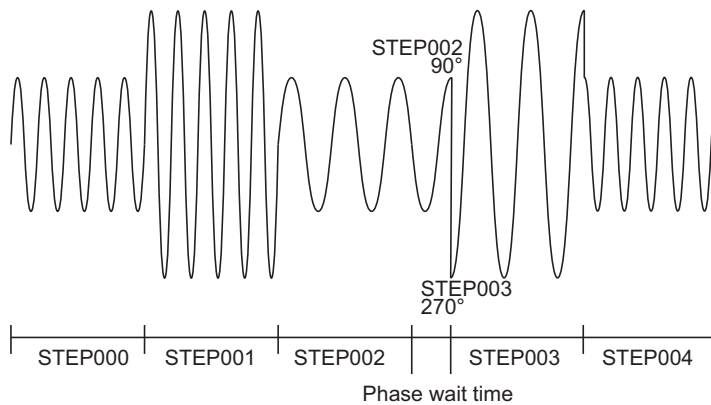

Step	000	001	002	003	004
ACVOLT [V] AC voltage	5.0	10.0	5.0	10.0	5.0
FREQ [Hz] Frequency	50.0	50.0	25.0	25.0	50.0
TIME [ms] Step time	100	100	100	100	100
OUTPUT Output	ON	ON	ON	ON	ON
S.PHASE [deg] Starting phase angle	0	FREE	FREE	270	FREE
E.PHASE [deg] Ending phase angle	FREE	FREE	90	FREE	FREE
PHAS.CHG Sudden phase change	OFF	OFF	OFF	ON	OFF

Note that even if you set both the starting and ending phase angles, if you do not set the sudden phase change function to on, the phase will not change suddenly.

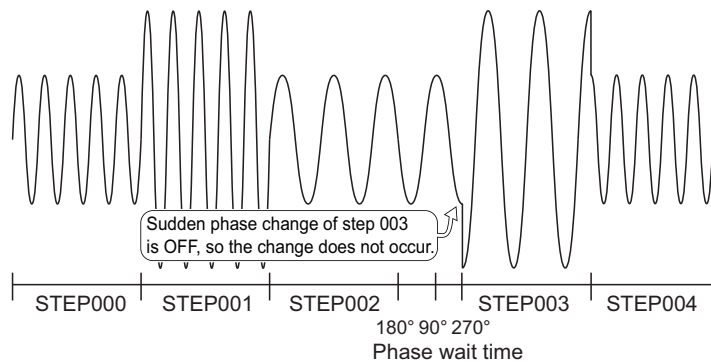

Step	000	001	002	003	004
S.PHASE [deg] Starting phase angle	0	FREE	FREE	270	FREE
E.PHASE [deg] Ending phase angle	FREE	FREE	90	FREE	FREE
PHAS.CHG Sudden phase change	OFF	OFF	OFF	OFF	OFF

Single-phase three-wire output and three-phase output basics

■ Single-phase three-wire output

In single-phase three-wire output, the V-phase waveform is an inverted waveform of the U phase.

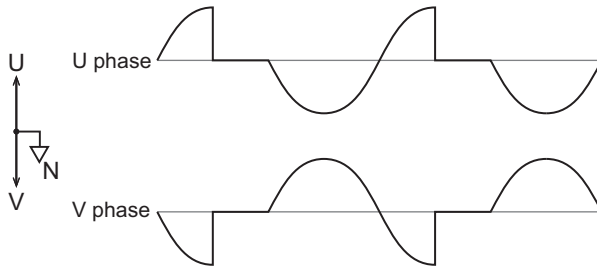

■ Three-phase output

The figure below shows the output of a three-step sequence where the U-V phase difference is 120° and the U-W phase difference is 240° (factory default setting).

The V phase lags the U phase by 120° . The W phase lags the U phase by 240° . You can set the U-V phase difference and the U-W phase difference in the sequence step settings.

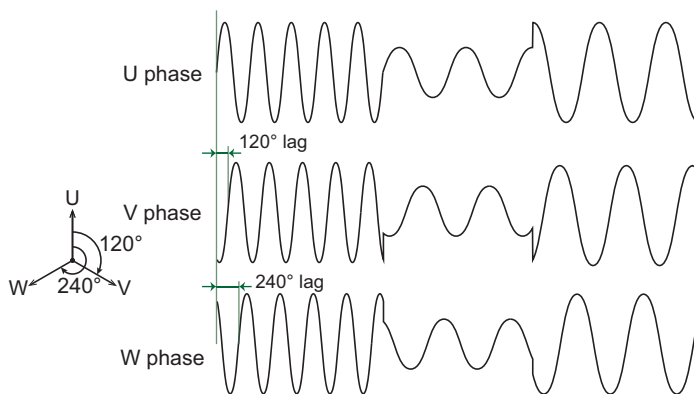

Phase setting for multi-phase output

This section explains how to set phase angles for multi-phase output. For details on the operation of starting and ending phase angles, see “Switching steps at specific phase angles” (p.137). For details on the operation of sudden phase changes, see “Suddenly changing the phase” (p.140).

NOTE For the U phase sudden phase change settings, set the starting phase, ending phase, and sudden phase change.
 For the V phase sudden-phase-change settings, set the U-V phase difference.
 For the W phase sudden-phase-change settings, set the U-W phase difference.

In the example below, the U phase suddenly changes from 0° to 180° when step 001 begins.

Because the U-V and U-W phase differences in step 001 are set to OFF, the U-V phase difference remains at 120° and the U-W phase difference remains at 240°. When the U phase is 0°, the V phase lags by 120°, so specify 240°. The W phase lags by 240°, so specify 120°. The V phase suddenly changes from 240° to 60° when step 001 begins. The W phase suddenly changes from 120° to 300°.

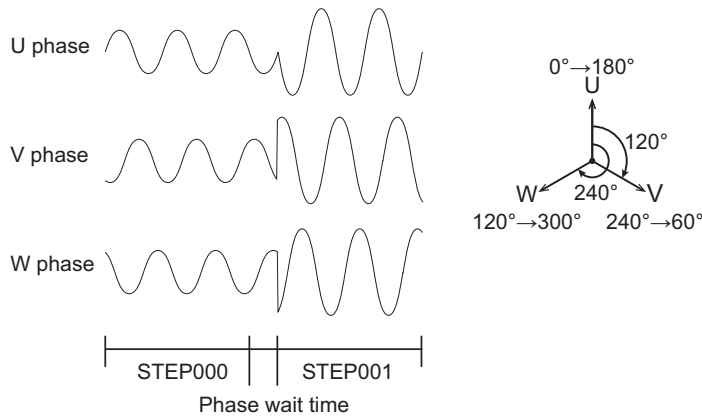

Step	000	001
S.PHASE [deg] Starting phase angle	FREE	180
E.PHASE [deg] Ending phase angle	0	FREE
PHAS. CNG sudden phase change	OFF	ON
U-V PHAS [deg] U-V phase difference	OFF	OFF
U-W PHAS [deg] U-W phase difference	OFF	OFF
U PHA.OFFS U phase offset	OFF	OFF

Next, we will explain how to set the steps so that only the U phase suddenly changes.

In the example below, the U phase is suddenly changed from 0° to 30° when step 001 begins. The waveforms of the V and W phases are continuous.

When step 001 begins, the U phase changes from 0° to 30°. If the U-V and U-W phase differences are set to OFF, the V phase will suddenly change from 240° to 270°, and the W phase will suddenly change from 120° to 150°. Because we want only the U phase to change suddenly, we add 30° to the phase differences (150° for the V phase and 270° for the W phase) so that the V and W phases will be continuous. When these settings are made, the waveforms of the V and W phases will be continuous.

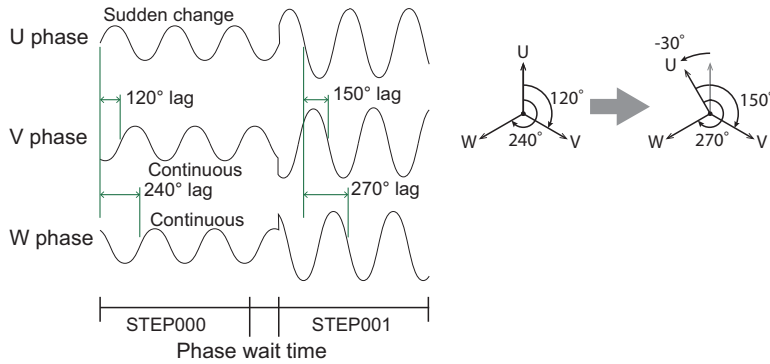

Step	000	001
S.PHASE [deg] Starting phase angle	FREE	30
E.PHASE [deg] Ending phase angle	0	FREE
PHAS. CNG sudden phase change	OFF	ON
U-V PHAS [deg] U-V phase difference	OFF	150
U-W PHAS [deg] U-W phase difference	OFF	270
U PHA.OFFS U phase offset	OFF	OFF

You can also set the U phase offset to cause the U phase to suddenly change, but in this case, the U-V/U-W phase difference settings will be offset from the actual phase difference. To avoid confusion, we recommend that you turn off the U phase offset.

For details, see ""Phase sweep" ([p.147](#))."

Lastly, we will explain how to set the steps so that the V and W phases suddenly change. To suddenly change the V phase, set the U-V phase difference. To suddenly change the W phase, set the U-W phase difference.

In the example below, the U-V phase difference is suddenly changed from 120° to 90° when step 001 begins. The waveforms of the U and W phases are continuous.

Step 000 ends when the U phase is 180°. When the U phase is 180° in step 000, the V-phase is 60°, because the U-V phase difference is 120°. Because the U-V phase difference is changed to 90° in step 001, the V-phase starts at $180^\circ - 90^\circ = 90^\circ$. This means that only the V phase suddenly changes from 60° to 90° when step 001 begins.

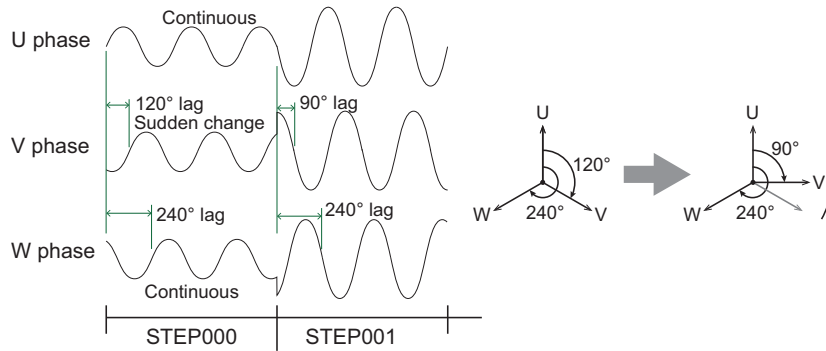

Step	0	1
S.PHASE [deg] Starting phase angle	FREE	FREE
E.PHASE [deg] Ending phase angle	FREE	FREE
PHAS. CNG sudden phase change	OFF	OFF
U-V PHAS [deg] U-V phase difference	OFF	90
U-W PHAS [deg] U-W phase difference	OFF	OFF
U PHA.OFFS U phase offset	OFF	OFF

The example below shows a sudden phase change in which step 001 begins at 0° when step 000 ends with the V phase at 90°. The waveforms of the U and W phases are continuous.

Because the U-V phase difference is 120°, the V phase is 90° when the U phase is 210°. We want the V phase to change at 90°, so we set the starting phase angle of step 001 to 210°. The U phase angle is 210° when step 001 begins. To make the V phase suddenly change to 0°, we set the U-V phase angle to 210°. The W phase is continuous, so we leave the U-W phase difference at OFF.

When the U phase angle of step 000 reaches 210°, step 001 begins. The V phase suddenly changes from 90° to 0°.

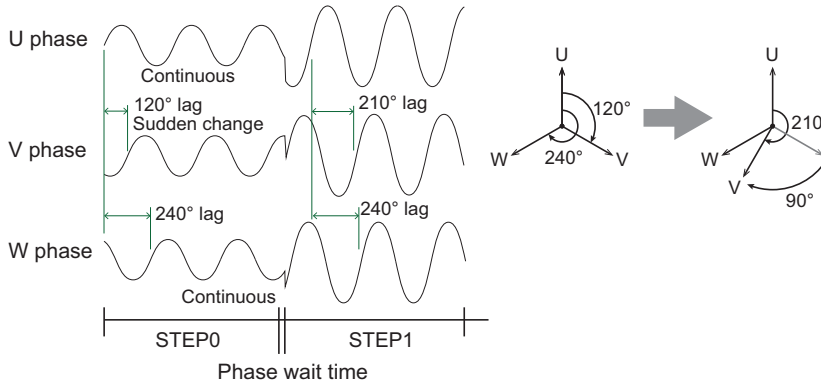

Step	000	001
S.PHASE [deg] Starting phase angle	FREE	210
E.PHASE [deg] Ending phase angle	FREE	FREE
PHAS. CNG sudden phase change	OFF	OFF
U-V PHAS [deg] U-V phase difference	OFF	210
U-W PHAS [deg] U-W phase difference	OFF	OFF
U PHA.OFFS U phase offset	OFF	OFF

Phase sweep

First, we will explain the phase sweeping of the U phase.

To sweep the U phase, you have to set the U phase offset.

When a U phase offset is specified, the U-V phase difference, U-W phase difference, starting phase angle, and ending phase angle settings are relative to the U phase reference phase.

Setting a U phase offset causes the U-V/U-W phase difference settings to be offset from the actual phase difference.

In the following example, U phase is swept from 0° to 330° (leading) from step 001 to step 002. V and W phases will not be changed.

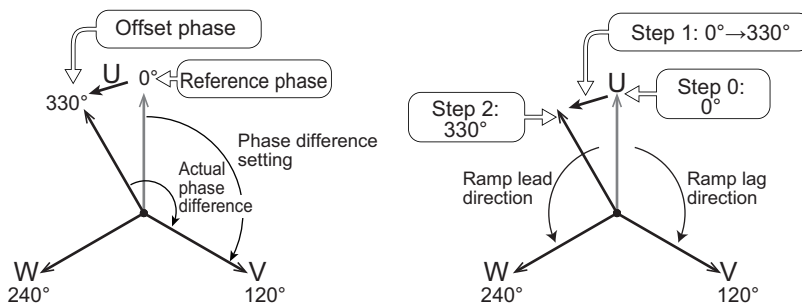

Specify the phase to sweep the U phase with the U phase offset.

Step	000	001	002
S.PHASE [deg] Starting phase angle	FREE	FREE	FREE
E.PHASE [deg] Ending phase angle	FREE	FREE	FREE
U PHA.OFFS [deg] U phase offset	0	330	330
RAMP (U PHA.OFFS) U phase ramp	OFF	LEAD	OFF
U-V PHAS [deg] U-V phase difference	OFF	OFF	OFF
RAMP (U-V PHAS) V phase ramp	--	--	--
U-W PHAS [deg] U-W phase difference	OFF	OFF	OFF
RAMP (U-W PHAS) W phase ramp	--	--	--
PHAS. CNG sudden phase change	OFF	OFF	OFF

Because we want to advance the phase from 0° to 330° in step 001, we set the U phase offset of step 001 to 330°.

Phase sweep ramp can be set to leading (LEAD) or lagging (LAG).

Set the ramp of step 001 to LEAD. “-” is displayed for U PHASE OFFSET.

The U-V phase difference and U-W phase difference are the phase difference from the U phase reference phase. Because we are not changing the V phase and W phase, we leave their settings at off (U-V phase difference: 120°, U-W phase difference: 240°).

The U-V phase difference and U-W phase difference are phase differences from the U phase reference phase, so if we set an offset for the U phase in step 001, even if the U-V phase difference setting is 120°, the actual phase difference will be 150° (120° + 30°), which means that the phase difference setting will be offset from the actual phase difference. Likewise, the U-W phase difference setting will be offset from the actual phase difference.

The output state when the sequence is complete is the state specified in the last step. If the sequence ends with a U phase offset, as in this example, the U PH OFS icon will appear.

If the icon is displayed, press SEQ (SHIFT+SIM) > 1/2 > U PHASE to clear the offset.

Next, we will explain the phase sweeping of the V and W phases.

Specify the phase to sweep the V phase with the U-V phase difference. Specify the phase to sweep the W phase with the U-W phase difference.

Below is an example of sweeping the V phase and an example of sweeping the U and V phases.

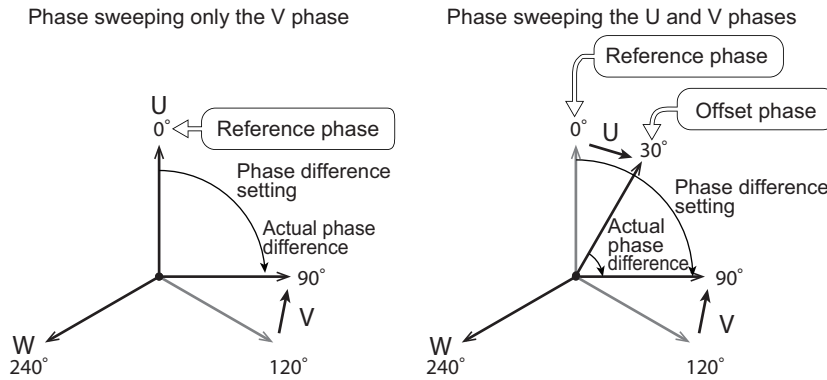

■ Phase sweeping only the V phase

Step	000	001	002
S.PHASE [deg] Starting phase angle	FREE	FREE	FREE
E.PHASE [deg] Ending phase angle	FREE	FREE	FREE
U PHA.OFFS [deg] U phase offset	OFF	OFF	OFF
RAMP (U PHA.OFFS) U phase ramp	OFF	OFF	OFF
U-V PHAS [deg] U-V phase difference	120	90	OFF
RAMP (U-V PHAS) V phase ramp	OFF	LEAD	OFF
U-W PHAS [deg] U-W phase difference	OFF	OFF	OFF
RAMP (U-W PHAS) W phase ramp	--	--	--
PHAS. CNG sudden phase change	OFF	OFF	OFF

■ Phase sweeping the U and V phases

To sweep the U and V phases, you have to set the U phase offset. In step 001, to sweep the U phase from 0° to 30° and the V phase from 120° to 90°, even though the actual U-V phase difference is 60°, we set the U-V phase difference to 90° because this value must be set relative to the U phase reference phase when a U phase offset is set. The U-V phase difference setting is offset from the actual phase difference.

Step	000	001	002
S.PHASE [deg] Starting phase angle	FREE	FREE	FREE
E.PHASE [deg] Ending phase angle	FREE	FREE	FREE
U PHA.OFFS [deg] U phase offset	0	30	30
RAMP (U PHA.OFFS) U phase ramp	OFF	LAG	OFF
U-V PHAS [deg] U-V phase difference	120	90	90
RAMP (U-V PHAS) V phase ramp	OFF	LEAD	OFF
U-W PHAS [deg] U-W phase difference	OFF	OFF	OFF
RAMP (U-W PHAS) W phase ramp	--	--	--
PHAS. CNG sudden phase change	OFF	OFF	OFF

Line voltage dip

The following example shows how to set line voltage dips (short two phases: 70% residual voltage).

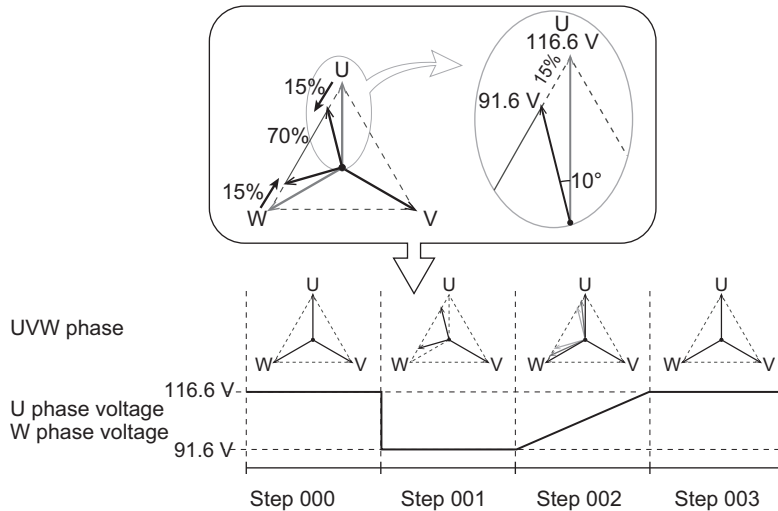

Step	000	001	002	003
ACVOLT [V] U phase AC voltage	116.6	91.6	116.6	116.6
RAMP (ACVOLT) U phase voltage ramp	OFF	OFF	ON	OFF
ACV V[V] V phase AC voltage	116.6	116.6	116.6	116.6
RAMP (ACV V) V phase voltage ramp	OFF	OFF	ON	OFF
ACV W [V] W phase AC voltage	116.6	91.6	116.6	116.6
RAMP (ACV W) W phase voltage ramp	OFF	OFF	ON	OFF
TIME [ms] Step time	100	100	100	100
S.PHASE [deg] Starting phase angle	FREE	FREE	FREE	FREE
E.PHASE [deg] Ending phase angle	FREE	FREE	FREE	FREE
U PHA.OFFS [deg] U phase offset	0	350	0	OFF
RAMP (U PHA.OFFS) U phase ramp	OFF	OFF	LAG	OFF
U-V PHAS [deg] U-V phase difference	120	OFF	OFF	OFF
RAMP (U-V PHAS) V phase ramp	OFF	--	--	---
U-W PHAS [deg] U-W phase difference	240	250	240	OFF
RAMP (U-W PHAS) W phase ramp	OFF	OFF	LEAD	---
PHAS. CNG sudden phase change	OFF	OFF	OFF	OFF

In step 001, we will suddenly change phases, and in step 002, we will sweep phases. For sudden phase changes, we normally do not use the U phase offset, but because we will use both sudden phase change and phase sweep in this example, we will set the sudden phase change using the U phase offset.

In step 001, we set the U-W line voltage to 70 %.

We set the U and W phase voltages to 91.6 V (ramp off), the U phase (U phase offset) to 350° (360° - 10°), and the W phase (U-W phase difference) to 250° (240° + 10°). Because these will be sudden changes, the U and W phase ramp settings are set to off.

In step 002, the U-W line voltage is varied from 70 % to 100 % over the duration of the step (1 second).

We set the U and W phase voltages to 116.6 V and the voltage ramp to on.

To sweep the U phase clockwise to 0°, we set the U phase (U phase offset) to 0° and set the ramp to LAG.

To sweep the W phase counterclockwise to 240°, we set the W phase (U-W phase difference) to 240° and set the ramp to LEAD.

External Control

The PCR-WE can be controlled and monitored from an external device.

Control	Functions that can be controlled/monitored	Connector
Analog control	Amplify the input waveform	ANALOG IN
	Change the voltage or frequency	
Digital control	Control using external contacts	DIGITAL I/O
	Monitor operating status	

■ External control connector

If you want to amplify the input waveform or change the voltage or frequency using analog signals, use the ANALOG IN connector.

If you want to use digital control, use the DIGITAL I/O connector.

If you want to use the ANALOG IN connector, use the optional analog control connector (OP02-PCR-WE).

If you want to use the DIGITAL I/O connector, use the included external control (DIGITAL I/O) connector. When shipped from the factory, the PCR6000WE2, PCR12000WE2, PCR18000WE2, PCR24000WE2, PCR30000WE2, and PCR36000WE2 have connectors inside the control panel.

For details on how to use the connectors, see the Hirose Electric catalog.

	ANALOG IN connector (OP02-PCR-WE)	DIGITAL I/O connector	Notes
Plug model	HDEB-9P(05)	HDBB-25P(05)	By Hirose Electric
Plug case	HDE-CTH(4-40)(10)	HDB-CTH(4-40)(10)	
Wire size	AWG28 to AWG20		Soldering (≤ 40 W, ≤ 4 seconds)

Control Using Analog Signals

External analog signals can be used to perform the following controls.

- Amplify the input waveform

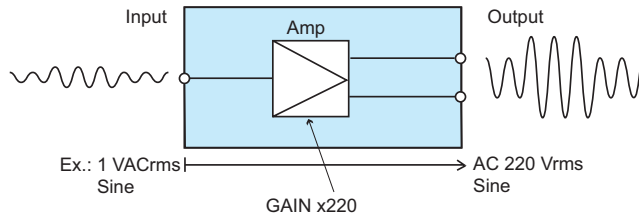

- Change the AC voltage, DC voltage, or frequency to output using a DC signal

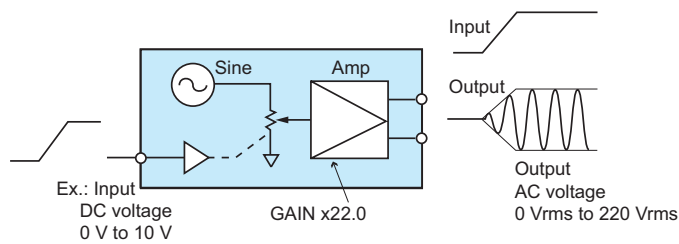

When the product is being controlled using external analog signals, voltage limits cannot be set. Applying an excessive external voltage by mistake can damage the load.

ANALOG IN connector pin arrangement

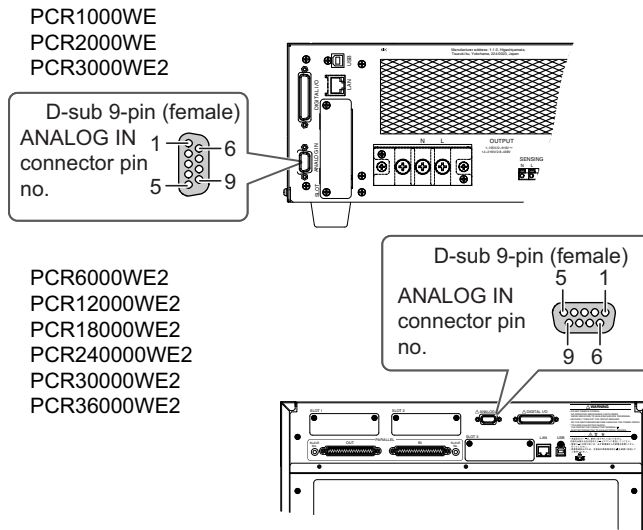

Pin no.	Terminal name
1	Ch. A
2	Ch. B
3	Ch. C
4	—
5	—
6	Ch. A COM
7	Ch. B COM
8	Ch. C COM
9	—

Selecting the parameter to control

Press OTHERS (SHIFT+MEMORY) > EXT ANLG (F4) > INPUT (F1) to set the parameter to control with the external analog signal.

Parameter	Title	Description
OFF(F1)	EXT Signal	Disables the use of the external analog signal
EXTDC(F2)		Amplifies the input waveform
VPROG(F3)		Varies the voltage or frequency of the output AC waveform

After selecting, press APPLY (F4) to apply the setting. Press CANCEL (F5) to cancel the settings.

If only the external signal source is in use when EXTDC is selected, "EXT" is displayed. If both the internal signal source and external signal source are in use, "INT+EXT" is displayed. If you select VPROG, "VPROG" is displayed.



Amplifying the input waveform (EXTDC mode)

You can use the PCR-WE as a power amplifier that simply amplifies the input waveform or use it to add an external signal to the PCR-WE signal source.

For single-phase output and single-phase three-wire output, Ch. A is used. Ch. B and Ch. C are disabled.

For three-phase output, Ch. A to Ch. C are used.

- Ch. A U phase control
- Ch. B V phase control
- Ch. C W phase control

Set the parameter to control with the external signal to "EXTDC." After selecting, set the signal source, polarity, and measurement time.

Selecting the signal source

Select which signal source to use to control the PCR-WE.

- Internal signal source and external signal source (INT+EXT)
An external signal source is added to the PCR-WE's internal signal source.
- External signal source (EXT)

The external signal (0 Vpk to 10 Vpk) is amplified 5 to 220 times.

Press OTHERS (SHIFT+MEMORY) > EXT ANLG (F4) > INPUT (F1) > EDIT (F5) > EXTDC (F2) > SOURCE (F1) to set the signal source.

Parameter	Title	Description
EXT(F2)	Signal Source	Uses an external signal
INT+EXT(F3)		Uses the internal signal and an external signal

Selecting the polarity

Select whether to output a signal whose polarity is the same as or opposite to that of the input signal.

For single-phase output and single-phase three-wire output, press OTHERS (SHIFT+MEMORY) > EXT ANLG (F4) > INPUT (F1) > EDIT (F5) > EXTDC (F2) > POL (F2) > Ch A (F1) to set the polarity.

For three-phase output, press OTHERS (SHIFT+MEMORY) > EXT ANLG (F4) > INPUT (F1) > EDIT (F5) > EXTDC (F2) > POL (F2), select the phase you want to set (Ch A, Ch B, Ch C), and then set the polarity. Ch A (F1) is the U phase, Ch B (F2) the V phase, and Ch C (F3) the W phase.

Parameter	Title	Description
NORM(F1)	Signal Polarity	Output a signal whose polarity is the same as the input signal.
INVERT(F2)	U Signal Polarity* ¹ V Signal Polarity* ¹ W Signal Polarity* ¹	Output a signal whose polarity is opposite to that of the input signal.

*1. Displayed for three-phase output

Setting the measurement time

If the measurement time is not set, the voltage and current that are being output may be different from what are displayed on the panel.

With a longer measurement time, the measurements become more stable, but it takes longer to update the display of the measured values. Guidelines for the measurement time when the signal includes an AC component are given below.

- When the period of the AC is known, you can obtain the most accurate measurement results if you set the measurement time to an integer multiple of the period.

Example: If the period of the AC component is 0.1 s, you can obtain the best results in the shortest time if you set the measurement time to 0.1 s.

- When the period of the AC component is unknown, you can obtain comparatively stable measurement results if you set the measurement time to a value that is at least 10 times the expected period.

Press OTHERS (SHIFT+MEMORY) > EXT ANLG (F4) > INPUT (F1) > EDIT (F5) > EXTDC (F2) > APERTURE (F3) to set the measurement time.

Parameter	Title	Description
APERTURE	Aperture Time	Sets the measurement time (0.1 s to 1.0 s, resolution: 0.1 s).

Generating output

After you set the signal source, polarity, and measurement time, apply an external signal to the ANALOG IN connector.

- 1** Turn the POWER switch off.
- 2** Connect an external signal (generator) to the ANALOG IN connector.
- 3** Turn the POWER switch on.
- 4** Press RANGE (SHIFT+8) to select the voltage range (L or H).
- 5** Apply the external signal to the ANALOG IN connector.
- 6** Turn the output on.

Adjusting the offset

You can adjust the offset. With the ANALOG IN connector shorted, adjust the offset so that the output voltage is as close to 0 Vdc as possible.

For single-phase output, press OTHERS (SHIFT+MEMORY) > EXT ANLG (F4) > INPUT (F1) > EDIT (F5) > EXTDC (F2) > USR ADJ (F2) > Ch A (F1) > OFFSET (F2).

For single-phase three-wire output and three-phase output, press OTHERS (SHIFT+MEMORY) > EXT ANLG (F4) > INPUT (F1) > EDIT (F5) > EXTDC (F2) > USR ADJ (F2), and then select the phase you want to set (Ch A, Ch B, Ch). Ch A (F1) is the U phase, Ch B (F2) the V phase, and Ch C (F3) the W phase. Then press OFFSET (F2).

Parameter	Title	Description
OFFSET	Ch A/B/C Offset	Sets the offset (-200 mV to 200 mV, resolution: 1 mV)

Adjusting the gain

You can set the gain between x5 to x220.

If you want to output 150 Vac (L range), apply 1.5 Vac to the ANALOG IN connector, and set the gain around x100.

For single-phase output, press OTHERS (SHIFT+MEMORY) > EXT ANLG (F4) > INPUT (F1) > EDIT (F5) > EXTDC (F2) > USR ADJ (F2) > Ch A (F1) > GAIN (F3).

For single-phase three-wire output and three-phase output, press OTHERS (SHIFT+MEMORY) > EXT ANLG (F4) > INPUT (F1) > EDIT (F5) > EXTDC (F2) > USR ADJ (F2), and then select the phase you want to set (Ch A, Ch B, Ch). Ch A (F1) is the U phase, Ch B (F2) the V phase, and Ch C (F3) the W phase. Then press GAIN (F3).

Parameter	Title	Description
GAIN	Ch A/B/C Gain	Sets the gain (x5 to x220, resolution: x0.01)

Limit function

If you use an external signal, you will not be able to use the following functions, in addition to the settings that were changed when you selected the signal source.

- When the internal signal source and an external signal source (INT+EXT) are in use

Harmonic current analysis function

Soft start, soft stop

Compensation (soft sensing, regulation adjustment)

- When an external signal source (EXT) is in use

Setting the output voltage or voltage limits

Setting the frequency or frequency limits

Memory usage

Generating special waveforms

Harmonic current analysis function

Power line abnormality simulations

Sequence function

Phase difference (only for single-phase three-wire output and three-phase output)

Soft start, soft stop

Compensation (soft sensing, regulation adjustment)

Varying the output voltage or frequency using DC signals (VPROG mode)

The following parameters can be varied using DC signals.

- AC voltage
In response to the external DC signal (0 Vdc to 10 Vdc) input, 0 Vac to 155 Vac (for L range) or 0 Vac to 310 Vac (for H range) is output.
- DC voltage
In response to the external DC signal (0 Vdc to 10 Vdc) input, 0 Vdc to 219 Vdc (for L range) or 0 Vdc to 438 Vdc (for H range) is output.
- Frequency
In response to the external DC signal (0 Vdc to 10 Vdc) input, 45 Hz to 65 Hz is output.

Set the parameter to control with the external signal to "VPROG" (p.154). After selecting, set the controlled parameter.

Selecting the controlled parameter for single-phase output and single-phase three-wire output

Set the channel to control using external analog signals.

- Channel configuration
Ch.A AC voltage control
Ch.B DC voltage control
Ch.C Frequency control

Press OTHERS (SHIFT+MEMORY) > EXT ANLG (F4) > INPUT (F1) > EDIT (F5) > VPROG (F3) > STATE (F2), select the channel (Ch A, Ch B, Ch C) you want to set, and then set whether to control it.

Parameter	Title	Description
ON(F1)	VProgram ChX State	Enables control
OFF(F2)		Disables control

Selecting the controlled parameter for three-phase output

Press OTHERS (SHIFT+MEMORY) > EXT ANLG (F4) > INPUT (F1) > EDIT (F5) > VPROG (F3) > MAP (F1) to select the channel configuration.

Parameter	Title	Description
ALL(F1)	VProgram map	Ch A: AC voltage, Ch B: DC voltage, Ch C: Frequency
ACVOLT(F2)		Ch A: AC voltage of U phase, Ch B: AC voltage of V phase, Ch C: AC voltage of W phase
DCVOLT(F3)		Ch A: DC voltage of U phase, Ch B: DC voltage of V phase, Ch C: DC voltage of W phase

Set the channel to control using external analog signals.

Press OTHERS (SHIFT+MEMORY) > EXT ANLG (F4) > INPUT (F1) > EDIT (F5) > VPROG (F3) > STATE (F2), select the channel (Ch A, Ch B, Ch C) you want to set, and then set whether to control it.

Parameter	Title	Description
ON(F1)	VProgram ChX State	Enables control
OFF(F2)		Disables control

Generating output

After you set the signal source, apply an external signal to the ANALOG IN connector.

- 1** Turn the **POWER** switch off.
- 2** Connect an external signal (generator) to the **ANALOG IN** connector.
- 3** Turn the **POWER** switch on.
- 4** Press **RANGE (SHIFT+8)** to select the voltage range (L or H).
- 5** Press **F > FREQ (F1)** to set the frequency (1.0 Hz to 5000 Hz).
- 6** Apply the external signal to the **ANALOG IN** connector.
- 7** Turn the output on.

Finely adjusting the offset and gain

You can finely adjust the voltage offset and gain. This is not applied to the frequency.

■ Adjusting the offset

You can adjust the offset. With the ANALOG IN connector shorted, adjust the offset so that the output voltage is as close to 0 Vdc as possible.

For single-phase output, press OTHERS (SHIFT+MEMORY) > EXT ANLG (F4) > INPUT (F1) > EDIT (F5) > VPROG (F3) > USR ADJ (F4) > Ch A (F1) > OFFSET (F2).

For single-phase three-wire output and three-phase output, press OTHERS (SHIFT+MEMORY) > EXT ANLG (F4) > INPUT (F1) > EDIT (F5) > VPROG (F3) > USR ADJ (F4), and then select the phase you want to set (Ch A, Ch B, Ch). Ch A (F1) is the U phase, Ch B (F2) the V phase, and Ch C (F3) the W phase. Then press OFFSET (F2).

Parameter	Title	Description
OFFSET	Ch A/B/C Offset	Sets the offset (-200 to 200, resolution: 1)

■ Adjusting the gain

You can set the gain between x5 to x50.

If the controlled parameter is AC voltage and you want to output 150 Vac (L range), apply 10 Vdc to the ANALOG IN connector, and set the gain around x15.

For single-phase output, press OTHERS (SHIFT+MEMORY) > EXT ANLG (F4) > INPUT (F1) > EDIT (F5) > VPROG (F3) > USR ADJ (F4) > Ch A (F1) > GAIN (F3).

For single-phase three-wire output and three-phase output, press OTHERS (SHIFT+MEMORY) > EXT ANLG (F4) > INPUT (F1) > EDIT (F5) > VPROG (F3) > USR ADJ (F4), and then select the phase you want to set (Ch A, Ch B, Ch). Ch A (F1) is the U phase, Ch B (F2) the V phase, and Ch C (F3) the W phase. Then press GAIN (F3).

Parameter	Title	Description
GAIN	Ch A/B/C Gain	Sets the gain (x5 to x50, resolution: x0.01)

- 1** Short the ANALOG IN connector.
- 2** Turn the output on.
- 3** Adjust the offset so that the output voltage is as close to 0 Vdc as possible.
- 4** Apply 10 Vdc to the ANALOG IN terminal.
- 5** Adjust the gain so that the output voltage is 150 Vdc (L range).
- 6** Apply 1 Vdc to the ANALOG IN terminal, and check that the output voltage is 15 Vdc (L range). If it is not, repeat steps 1 to 5 until the output voltage is 15 Vdc (L range).

When you adjust either the offset or the gain, the other value that you adjusted before may shift. Be sure to check it.

- 7** The output is turned off.

Limit function

If an external signal is used, you will not be able to use the following functions.

- Soft start
- Power line abnormality simulations
- Sequence function
- Harmonic analysis function

Control Using Digital Signals

External digital signals can be used to perform the following controls.

- Controlling the PCR-WE through external contacts
- Monitoring the operation status

DIGITAL I/O connector pin arrangement and mapping

There are four channels (CTRL.1 to CTRL.4) that are controlled using external contacts, four channels (STAT.1 to STAT.4) that monitor the operating status, and two channels (DIO.1, DIO.2) that you can select whether to control using external contacts or monitor the operating status (Selectable I/O).

These channels are accessible through the DIGITAL I/O connector.

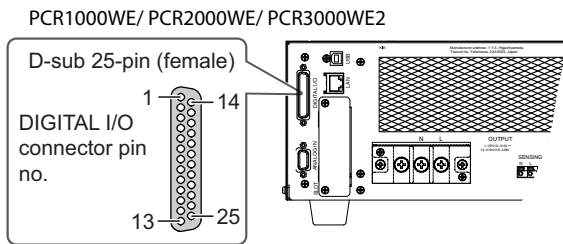

PCR6000WE2/ PCR12000WE2/ PCR18000WE2/
PCR24000WE2/ PCR30000WE2/ PCR36000WE2

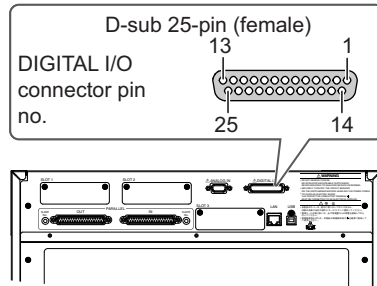

Pin no.	In/Out	Terminal name
1	IN	CTRL.1
2	IN	CTRL.2
3	IN	CTRL.3
4	IN	CTRL.4
5		—
6	OUT	STAT.1
7	OUT	STAT.2
8	OUT	STAT.3
9	OUT	STAT.4
10		—
11	IN/ OUT	DIO.1
12	IN/ OUT	DIO.2
13		—
14	IN	CTRL.1 COM
15	IN	CTRL.2 COM
16	IN	CTRL.3 COM
17	IN	CTRL.4 COM
18		—
19	OUT	STAT.1 COM
20	OUT	STAT.2 COM
21	OUT	STAT.3 COM
22	OUT	STAT.4 COM
23		—
24	IN/ OUT	DIO.1 COM
25	IN/ OUT	DIO.2 COM

Control signals that can be mapped to the pins

The signals to be controlled can be mapped to the channels of the DIGITAL I/O connector. The following table shows the signals that can be mapped. CTRL.4 and STAT.4 cannot be mapped.

For details, see “Controlling the PCR-WE through external contacts” (p. 166), “Monitoring the operation status” (p. 171), and “Selectable I/O” (p. 174).

When using external contacts for control or the selectable I/O as input, the same control signal cannot be assigned to multiple channels (CTRL.1 to CTRL.4, DIO.1, DIO.2).

When monitoring the operating status or the selectable I/O as output, the same control signal can be assigned to multiple channels (STAT.1 to STAT.4, DIO.1, DIO.2).

Control signal		CTRL.1 to CTRL.3	CTRL.4	STAT.1 to STAT.3	STAT.4	DIO.1 DIO.2
Output on/off	IN	✓				✓
Sequence run/stop	IN	✓				✓
Alarm clear	IN	✓				✓
External alarm input	IN	✓				✓
Output method change (single-phase)	IN	✓				✓
Output method change (single-phase three-wire)	IN	✓				✓
Output method change (three-phase)	IN	✓				✓
Output range change	IN	✓				✓
Preset memory A recall	IN	✓				✓
Preset memory B recall	IN	✓				✓
Preset memory C recall	IN	✓				✓
Output on inhibit	IN	✓				✓
Programmable signal in	IN	✓				✓
Shutdown	IN		✓			
Output reference phase input	IN					✓
Sequence trigger input	IN					✓
Output on status	OUT			✓		✓
Peak current limit status	OUT			✓		✓
Overload status	OUT			✓		✓
Busy status	OUT			✓		✓
Output method status (single-phase)	OUT			✓		✓
Output method status (single-phase three-wire)	OUT			✓		✓
Output method status (three-phase)	OUT			✓		✓
Output voltage H range status	OUT			✓		✓
POWER switch on status	OUT			✓		✓
Sequence/power line abnormality simulation status output	OUT			✓		✓
Programmable signal status	OUT			✓		✓
Alarm status	OUT			✓	✓	✓
Output reference phase output	OUT					✓
Sequence trigger output	OUT					✓

Controlling with external contacts using CTRL channels

To reduce the influence of noise on the output, connect a 2-core shielded wire or a twisted-pair wire, and keep the wire as short as possible. If the wiring is long, it becomes easy for noise to influence the operation of the PCR-WE. Even if you use cables that are designed to suppress noise, the PCR-WE may not operate properly.

The maximum open-circuit voltage across input pins is approximately 12 V, and the maximum short-circuit current is approximately 7.1 mA (the internal circuits are pulled up to 12 V with 1.7 kΩ resistors).

Use external contacts that have a contact rating greater than or equal to 7.1 mA at 12 Vdc.

High-level input voltage: 11 V to 12 V, or open

Low-level input voltage: 0 V to 1 V

You can set the active signal polarity for each channel.

If you are using a shielded cable, connect the shield to the connector shell.

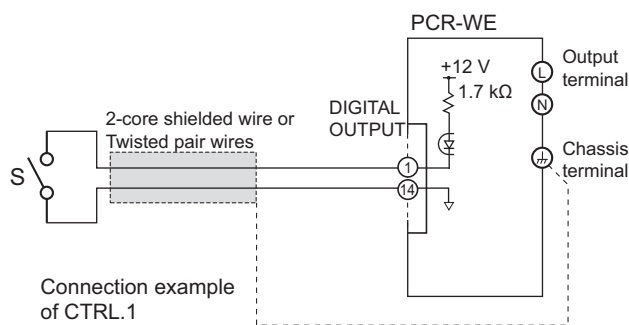

■ For long-distance wiring

When you are wiring over a great distance, use a small relay and extend the coil side of the relay.

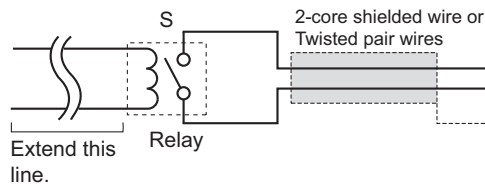

Monitoring the operating status using STAT channels

The output signal is an open-collector output from a photocoupler (30 Vdc, 8 mA max.). It is isolated from the inside of the product.

You can set the active signal polarity for each channel.

Maximum voltage: 30 V

Maximum current (sink): 8 mA

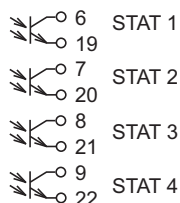

Controlling the PCR-WE through external contacts

There are four channels (CTRL.1 to CTRL.4) that can be controlled through external contacts.

For CTRL.1 to CTRL.3, you can select (map) control signals. CTRL.4 is fixed to shutdown signal.

There are two additional channels (DIO.1, DIO.2) that you can select whether to control using external contacts or monitor the operating status ([p. 174](#)).

The same control signal cannot be assigned to multiple channels (CTRL1 to CTRL4, DIO.1, DIO.2).

Signals controllable through external contacts		
Output on/off	Output Control	
Sequence run/stop	SEQ Execution Control	
Alarm clear	Alarm Clear	
External alarm input	External Alarm	
Output method change (single-phase)	Wiring Control 1P	
Output method change (single-phase three-wire)	Wiring Control 1P3W	
Output method change (three-phase)	Wiring Control 3P	
Output range change	Volt Range	
Preset memory A recall	Recall A Memory	
Preset memory B recall	Recall B Memory	
Preset memory C recall	Recall C Memory	
Output-on inhibit	Output Inhibit	
Programmable signal in	Programmable Signal	
Shutdown	Shutdown	Fixed to CTRL.4

Output reference phase input and sequence trigger input can be controlled by specifying “Selectable I/O” ([p. 174](#)).

- 1** Press **CONFIG (SHIFT+OPR MODE) > EXT.DIO (F2) > CTRL.IN (F1)**.
- 2** Select the channel (**CTRL.1(F1)/ CTRL.2(F2)/ CTRL.3(F3)**) you want to assign the parameter to.
CTRL.4 is fixed (shutdown). You cannot set this value.
- 3** Press **ENABLE (F1)** to enable external contact control on the assigned channel.
If you want to disable it, press **DISABLE (F2)**.
- 4** Use the rotary knob to select the signal to control with an external contact.

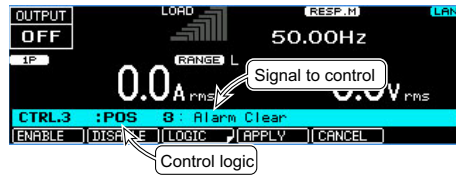

- 5** Select the control logic.
To set logical true to high, select **POS (F3)**. To set logical true to low, select **NEG (F4)**.
- 6** Press **APPLY (F4)**.
To cancel, press **CANCEL (F5)**.
This completes the setting.

■ Turning output on and off (Output Control)

If two or more units are floating, and you are using a single external contact to turn output on and off for all the units, use a relay or similar device for the external contact signal to isolate the signal transmitted to each unit.

The figure below shows an example of output on/off control when a high level signal turns the output on.

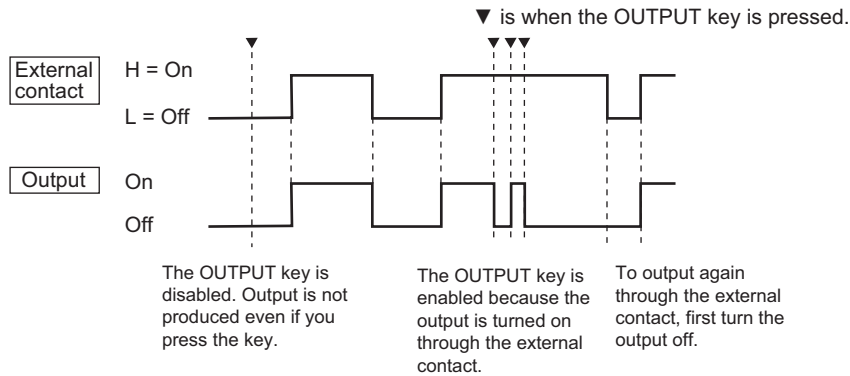

When a sequence is running or when soft start/soft stop is set to on, the output on/off control through external contacts is invalid.

■ Running and stopping a sequence (SEQ Execution Control)

Sequence execution can be controlled through external contacts.

When a sequence is stopped through external contacts, RUN (F1) on the front panel is invalid. If you do not want to control the sequence through external contacts, select DISABLE.

The following figure shows an example of sequence execution control when a high level signal is used to run the sequence.

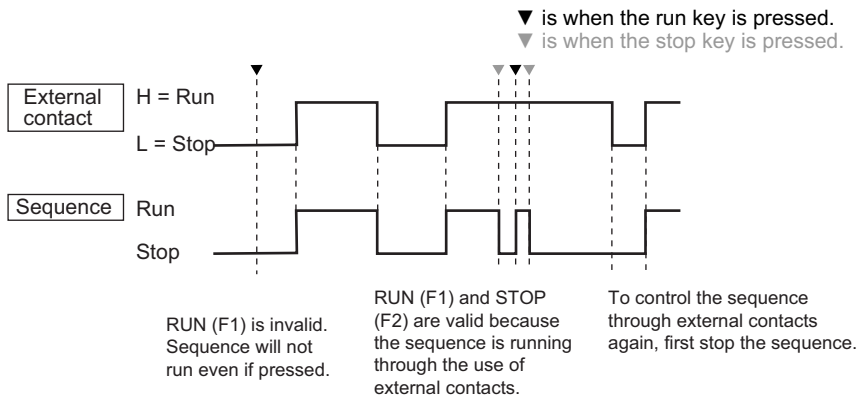

■ Clearing alarms (Alarm Clear)

Alarms can be cleared through external contacts.

■ **External alarm input (External Alarm)**

Alarms can be generated through external contacts. "ALM-19 EXT ALARM" is displayed, and the output turns off.

■ **Changing the output method (Wiring Control)**

The output method can be changed through external contacts (excluding the PCR1000WE and PCR2000WE).

■ **Switching the output voltage range (Volt Range)**

The output voltage range can be changed through external contacts. Logical true sets the output voltage range to H range.

■ **Recalling settings from preset memory (Recall)**

Settings can be recalled from preset memory through external contacts.

■ **Inhibiting the output from being turned on (Output Inhibit)**

The output-on inhibit function can be controlled through external contacts.

When output-on inhibit is enabled, the output will not turn on even when the OUTPUT key is pressed. Nor can it be turned on through external control.

The following example shows an example of output control when output-on inhibit is enabled and a high level signal is used to turn on the output.

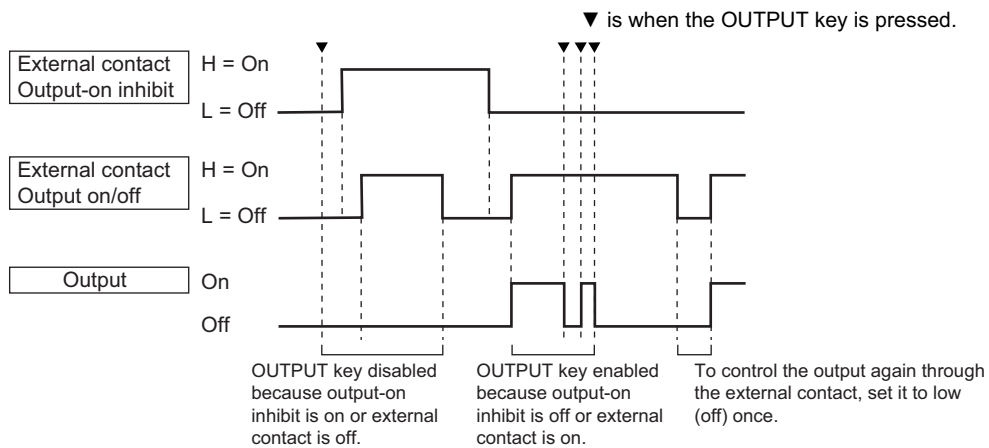

■ **Programmable signal in (Programmable Signal)**

You can query the status of the external signal applied to the pin using SCPI commands.

If you connect the EUT status information, you will be able to monitor the EUT status using commands.

CTRL.1 : Programmable Signal1 In

CTRL.2 : Programmable Signal2 In

CTRL.3 : Programmable Signal3 In

■ Shutdown

CTRL.4 is used for shutdown.

The output can be turned off by force through external contacts. This takes precedence over the feature that turns the output on and off through external contacts. The power module operation is also stopped.

The logical polarity is fixed (positive).

When an active signal is received, "TRBL-19 EXT. SHUTDOWN" is displayed on the panel.

- Recovery

Turn the POWER switch off.

Clear the active signal input, and then turn the POWER switch on.

Monitoring the operation status

You can externally monitor the following operation status of the product.

There are four channels for monitoring (STAT.1 to STAT.4).

For STAT.1 to STAT.3, you can select (map) control signals. STAT.4 is fixed to alarm status.

There are two additional channels (DIO.1, DIO.2) that you can select whether to control using external contacts or monitor the operating status ([p. 174](#)).

The same control signal can be assigned to multiple channels (STAT.1 to STAT.4, DIO.1, DIO.2).

Signal for monitoring the operating status		
Output on status	Output ON Status	
Peak current limit status	I Pk Limit Status	
Overload status	Overload Status	
Busy status	Busy Status	
Output method status (single-phase)	Wiring 1P Status	
Output method status (single-phase three-wire)	Wiring 1P3W Status	
Output method status (three-phase)	Wiring 3P Status	
Output voltage H range status	Volt Range H Status	
POWER switch on status	Power ON Status	
Sequence/power line abnormality simulation status output	SEQ Status Out	
Programmable signal status	Programmable Signal	
Alarm status	Alarm Status	Fixed to STAT.4

Output reference phase output status and sequence trigger output can be controlled by specifying "Selectable I/O" ([p. 174](#)).

- 1** Press **CONFIG (SHIFT+OPR MODE) > EXT.DIO (F2) > STAT.OUT (F2)**.
- 2** Select the channel (**STAT.1(F1)/ STAT.2(F2)/ STAT.3(F3)**) you want to assign the parameter to.
STAT.4 is fixed (alarm status). You cannot set this value.
- 3** Press **ENABLE (F1)** to enable monitoring on the assigned channel.
If you want to disable it, press **DISABLE (F2)**.
- 4** Use the rotary knob to select the signal for monitoring the operating status.

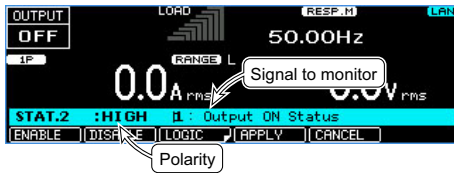

- 5** Select the status polarity (**HIGH(F3)/ LOW(F4)**).
- 6** Press **APPLY (F4)**.
To cancel, press **CANCEL (F5)**.
This completes the setting.

■ **Output (Output ON Status)**

The signal turns on when the output is on.

■ **Peak current limit (I Pk Limit Status)**

The signal turns on when the peak current limit is exceeded and the current peak is being limited (IPKLIM indication).

■ **Overload (Overload Status)**

The signal turns on when the current limit is exceeded.

■ **Busy (Busy Status)**

The signal turns on when the output cannot be turned on (busy status).

■ Output method status (Wiring Status, excluding the PCR1000WE and PCR2000WE)

Wiring 1P Status is set to on for single-phase output.

Wiring 1P3W Status is set to on for single-phase three-wire output.

Wiring 3P Status is set to on for three-phase output.

When you use two channels, you can check the output method.

■ Output voltage H range status (Volt Range H Status)

The signal turns on when the PCR-WE is set to H range.

■ POWER switch on status (Power ON Status)

The signal turns on when the POWER switch is turned on.

■ Sequence status (SEQ Status Out)

The signal turns on when the status is being output while a sequence is running.

The signal turns on for the periods T2, T3, and T4 in power line abnormality simulations.

■ Programmable signal status (Programmable Signal)

Digital signals can be output using SCPI commands.

STAT.1 : Programmable Signal1 Out

STAT.2 : Programmable Signal2 Out

STAT.3 : Programmable Signal3 Out

■ Alarm status

The signal turns on when an alarm or trouble is detected.

When the cause of the alarm is resolved, the signal turns off.

Selectable I/O

There are two selectable I/O channels (DIO.1, DIO.2) that you can select whether to control using external contacts or monitor the operating status .

You can select (map) control signals.

When using external contacts for control, the same control signal cannot be assigned to multiple channels (CTRL.1 to CTRL.4, DIO.1, DIO.2).

When monitoring the operating status, the same control signal can be assigned to multiple channels (STAT.1 to STAT.4, DIO.1, DIO.2).

Signals controllable through external contacts	
Output reference phase input	Sync Clock In
Sequence trigger input	SEQ Trigger In
Output on/off	Output Control
Sequence run/stop	SEQ Execution Control
Alarm clear	Alarm Clear
External alarm input	External Alarm
Output method change (single-phase)	Wiring Control 1P
Output method change (single-phase three-wire)	Wiring Control 1P3W
Output method change (three-phase)	Wiring Control 3P
Output range change	Volt Range
Preset memory A recall	Recall A Memory
Preset memory B recall	Recall B Memory
Preset memory C recall	Recall C Memory
Output on inhibit	Output Inhibit
Programmable signal in	Programmable Signal

Signal for monitoring the operating status	
Output reference phase output	Standard Clock Out
Sequence trigger output	SEQ Trigger Out
Output on status	Output ON Status
Peak current limit status	I Pk Limit Status
Overload status	Overload Status
Busy status	Busy Status
Output method status (single-phase)	Wiring 1P Status
Output method status (single-phase three-wire)	Wiring 1P3W Status
Output method status (three-phase)	Wiring 3P Status
Output voltage H range status	Volt Range H Status
POWER switch on status	Power ON Status
Sequence/power line abnormality simulation status output	SEQ Status Out
Programmable signal status	Programmable Signal

- 1** Press CONFIG (SHIFT+OPR MODE) > EXT.DIO (F2) > SEL DIO (F3).
- 2** Select the channel (DIO.1(F1)/ DIO.2(F2)) you want to assign the parameter to.
- 3** If you want to control through external contacts press INP.SIG (F1). If you want to monitor the operating status, press OUTP.SIG (F2). To disable the channel, press DISABLE (F3).
- 4** Use the rotary knob to select the signal to control or monitor.

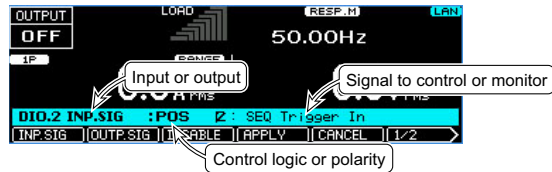

- 5** Press 2/2 (F6) > LOGIC (F3) to select the control logic or status polarity.

If you want to control through external contacts and set the polarity to high, press POS (F3). If you want to set the polarity to low, press NEG (F4).

If you want to monitor the operating status, press HIGH (F3) or LOW (F4). If you want to set the status polarity to NORMAL, press NORM (F3). If you want to set it to INVERTED, press INV (F4).
- 6** Press APPLY (F4).

To cancel, press CANCEL (F5).

This completes the setting.

Selectable signals when INP.SIG is selected

For details on topics other than the output reference phase input, sequence trigger input, and programmable signal in, see “Control Using Digital Signals” ([p.162](#)).

■ Output reference phase signal (Sync Clock In)

Apply a signal when you want to synchronize the sync function with an external signal.

■ Sequence trigger input (SEQ Trigger In)

If a sequence is paused and is waiting for a trigger and a signal is received, the sequence resumes.

■ Programmable signal in (Programmable Signal)

You can query the status of the external signal applied to the pin using SCPI commands.

If you connect the EUT status information, you will be able to monitor the EUT status using commands.

DIO.1 : Programmable Signal4 In

DIO.2 : Programmable Signal5 In

Selectable signals when OUTP.SIG is selected

For details on topics other than the output reference phase output, sequence trigger output, and programmable signal status, see “Monitoring the operation status” ([p.171](#)).

■ Output reference phase output

A signal for sync function (a signal that inverts its logic at output phase 0° and 180°) is generated.

If the “U PH OFS” icon is displayed (sequence ended with a U phase offset), a phase difference will exist between the reference phase and U phase.

■ Trigger output while a sequence is running

While a sequence is running, a trigger signal is generated when a step whose trigger output is set to on is executed.

■ Programmable signal status (Programmable Signal)

Digital signals can be output using SCPI commands.

DIO.1 : Programmable Signal4 Out

DIO.2 : Programmable Signal5 Out

Parallel Operation

This product is capable of master-slave parallel operation, which allows all slave units to be controlled by a master unit (excluding the PCR1000WE, PCR2000WE, and PCR3000WE2, up to four units). If the input wiring system is the same, parallel operation is possible even among models with different power capacities.

The power capacity of each phase is limited to 48 kVA, and the maximum current is limited to 480 A. When four PCR36000WE2 units are used, the power capacity for three-phase output is 144 kVA and 48 kVA for single-phase output.

If the response is set to high-speed (FAST), it is changed to normal speed (MEDIUM) during parallel operation.

Configuring the Master and Slave Units

In parallel operation, the master unit controls all slave units.

The master unit's panel shows the measurements, and the slave units' panels show their slave unit numbers.

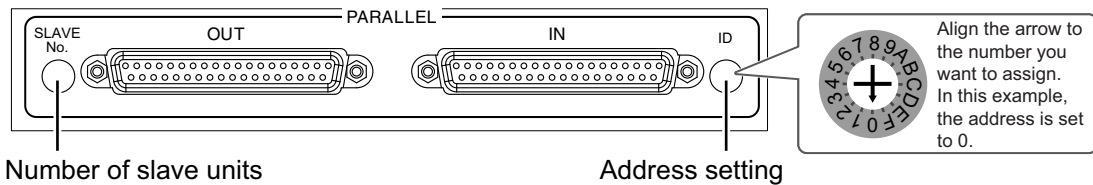

1 Turn the POWER switch off (O).

2 On the PCR-WE, you set the addresses of the master and slave units and the number of slave units.

Using a screwdriver, align the rotary switch arrow of the PARALLEL connector on the rear panel to the number of your choice.

Assign unique addresses to each unit.

- Settings for performing parallel operation with two units

	Master	Slave 1
Address	0	1
Number of slave units	1	1

- Settings for performing parallel operation with three units

	Master	Slave 1	Slave 2
Address	0	1	2
Number of slave units	2	2	2

- Settings for performing parallel operation with four units

	Master	Slave 1	Slave 2	Slave 3
Address	0	1	2	3
Number of slave units	3	3	3	3

If the address or the number of slave units is not set correctly, a trouble indication (TRBL-31: P.D SYSTRM ERR) is generated.

Installation and Connection

Installation

Use the master unit to control all the slave units. It is convenient to place the master unit in an easy-to-operate location.

Using the optional parallel operation connection cable (PC01-PCR-WE), connect the PCR-WEs. Arrange the PCR-WEs so that they are as close to each other as possible (so that tension is not applied to the connecting cables).

To synchronize the power supply, the optional power synchronize cable (LC01-PCR-LE) is required.

Connecting PCR-WEs together



Risk of electric shock.

- **Be sure to turn off the switchboard before connecting cables.**
- **Do not use the terminal block with the terminal cover removed.**



Risk of malfunction.

Use load cables with a thickness (conductor cross-sectional area) equivalent to that of the load cable for each PCR-WE.



To acquire stable measurements, be sure to use a relay terminal board to connect the load.

- 1 Turn the **POWER** switch off.
- 2 Securely connect the master unit's **PARALLEL OUT** connector to the slave unit's **PARALLEL IN** connector using a parallel operation connection cable. To perform parallel operation with three or more units, connect all **PARALLEL** connectors using connection cables in the same manner.

Signals flow from the OUT connector to the IN connector. Make sure the IN and OUT connections are correct.

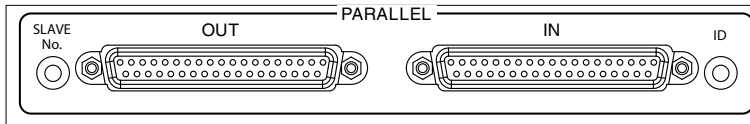

Example of parallel operation using three PCR-WEs

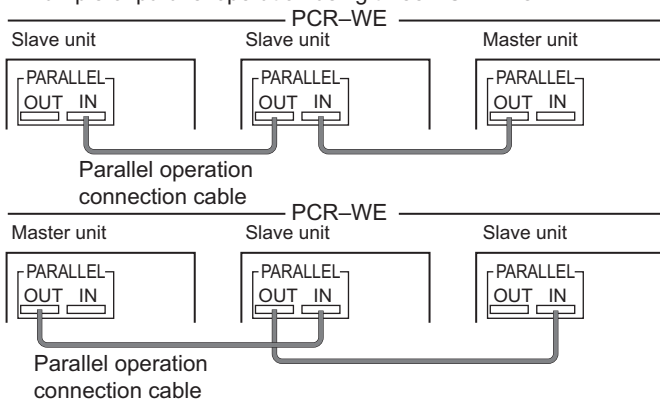

This completes the parallel connections.

Connection and configuration for synchronizing the power supply

To synchronize the power supply, the optional power synchronize cable (LC01-PCR-LE) is required. You can configure the system so that when you turn on the master unit, all the slaves also turn on.

- 1 Remove the terminal covers.**
- 2 Securely connect the master unit's J2 connector to the slave unit's J1 connector using the optional power signal cable. To perform parallel operation with three or more units, connect all J1 and J2 connectors using connection cables in the same manner.**

Signals flow from the J2 connector to the J1 connector. Make sure the J1 and J2 connections are correct.

Push the power synchronize cables in until they are locked in place.

Example of parallel operation using three PCR-WEs

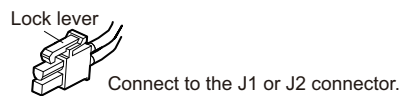
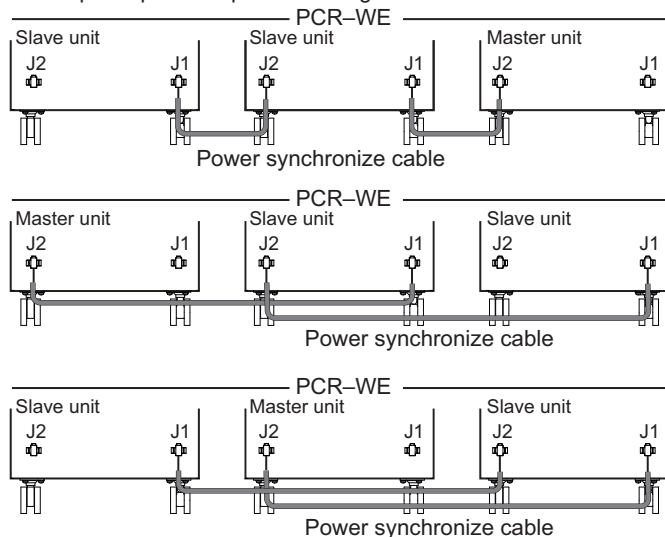

- 3 Attach the terminal covers.**

Do not allow the power synchronize cables to be caught in the terminal cover.

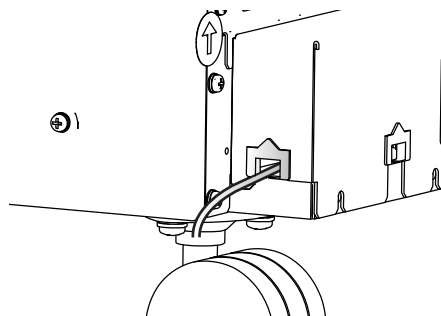

4 Set the master unit's POWER SELECTOR switch to MASTER.

The POWER SELECTOR switch is on the front panel.

5 Set the all slave units' POWER SELECTOR switches to SLAVE.

6 Turn on all slave units' POWER switches.

This completes power synchronize cable connections.

To disable the power supply synchronization, set the slave units' POWER SELECTOR switches to MASTER.

NOTE The power supply sync signal flows from the J2 connector to the J1 connector. When you operate the master unit's POWER switch, the slave units' power supplies operate in sync.

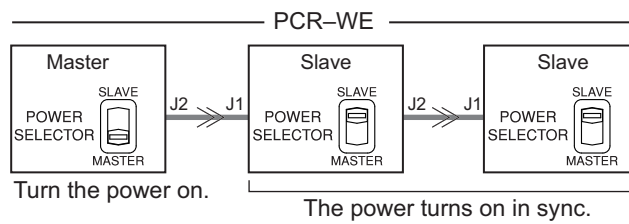

Turning the Power On and Checking the Operation

Parallel operation is controlled from the master unit.

The master unit displays the total output current of the system.

Connecting the OUTPUT terminal block and relay terminals

Refer to the following figure, and connect the OUTPUT terminal block and relay terminals. For details on connecting the load, see "Connecting the Load" (p. 27).

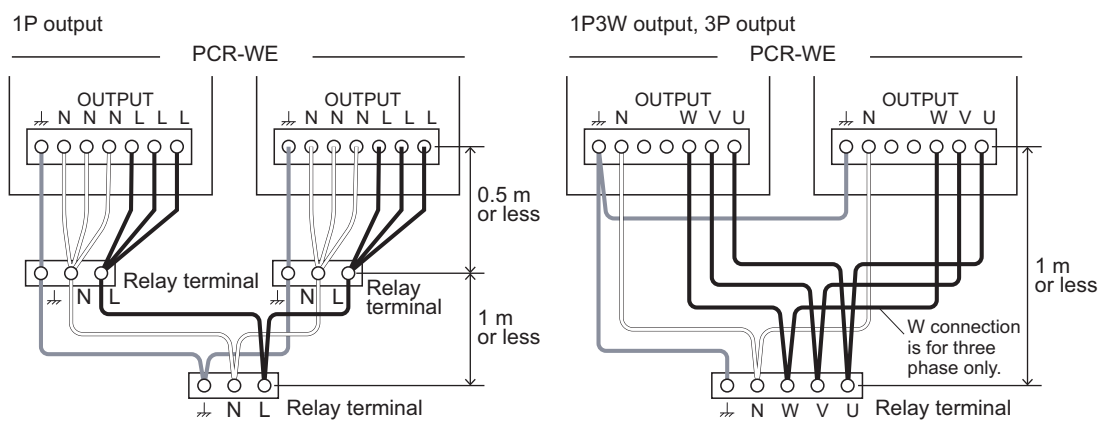

If the output method to the load changes, connect all terminals.

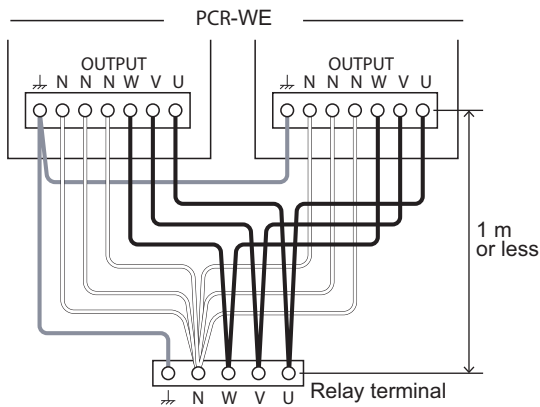

Turning the power on

■ Power on

If power supply syncing is enabled, turn on the master unit's POWER switch.

If power supply syncing is disabled, turn on the POWER switches on the master unit and all slave units within 10 seconds.

The firmware version is displayed for a few seconds. If there are no errors, the master unit displays the home position (the basic screen), and the slave units display "SLAVE-x" (where x is the slave unit number).

Parallel operation is controlled from the master unit. You cannot control from a slave unit's panel.

■ Turning the power off

If power supply syncing is enabled, turn off the master unit's POWER switch.

If power supply syncing is disabled, turn off the POWER switches on the master unit and all slave units.

For emergency situations, we recommend that you insert a circuit breaker that separates the entire system from the switchboard.

Operation Check

Check the operation of the PCR-WE before connecting the load.

Check the following items with no load connected.

- POWER switch on
- Voltage setting
- OUTPUT on/off
- Voltage range switching

If a problem is occurring on even one unit, you will not be able to perform parallel operation.

Connecting the Load

Connect the relay terminals and the load.



Risk of electric shock.

- Before you connect cables, be sure to turn the **POWER** switch off, and then remove the power plug from the outlet or turn off the switchboard.
- Do not use the terminal block with the terminal cover removed.



Risk of malfunction.

- Do not reverse the L and N polarities.
- Use noncombustible cables with a thickness appropriate for the output current to connect from the relay terminal to the load.

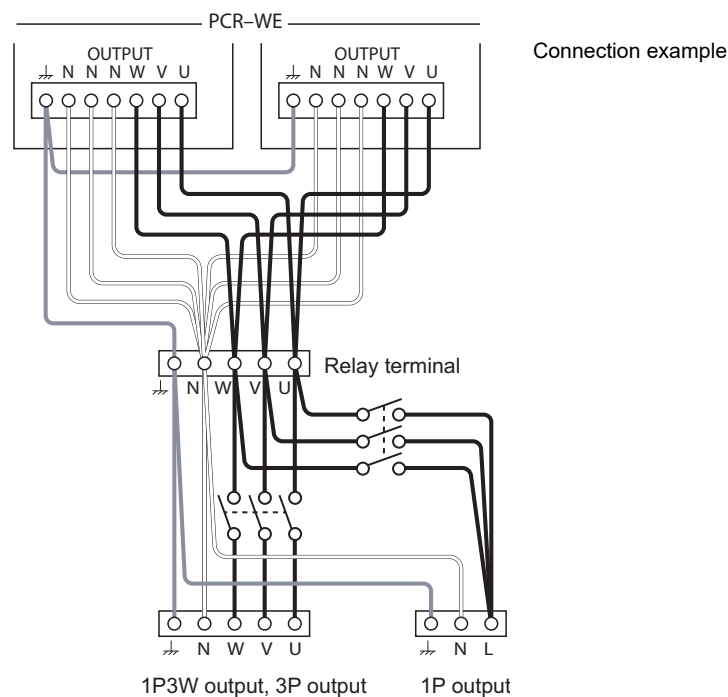

Ending parallel operation

To end parallel operation, turn off the power, and then remove the connection cables from the PARALLEL connectors and the power synchronize cables from the J1 and J2 connectors. Hold down the lock lever of the power synchronize cable, and pull it free of the unit.

Set rotary switches of the number of slave units and addresses to zero.

If the power supplies are synchronized, set the POWER SELECTOR switches to MASTER with the POWER switch turned off.

If the current limit setting on the master unit exceeds the rated current, the current limit will be changed to the maximum value for that PCR-WE alone.

System Settings

Setting the Watchdog Protection (WDP)

This function turns off PCR-WE output when SCPI communication is not performed for a length of time that is equal to or exceeds the WDP setting.

Press CONFIG (SHIFT+OPR MODE) > COM-I/F (F1) > 1/2 (F6) > WT DOG (F1) to set the watchdog protection.

Parameter	Title	Description
ON(F1)	WT DOG State	Enables watchdog protection
OFF(F2)		Disables watchdog protection
DELAY(F3)	WT DOG Delay	Sets the time until the watchdog protection is activated (1 s to 3600 s)

Displaying/Changing the Interface Settings

For details on connections and configuration, see the Communication Interface Manual (in the included CD-ROM).

Controlling the PCR-WE/WE2 from a PC

You can control the PCR-WE/WE2 from a PC by using the Web browser interface.

To use the Web browser interface, you need to connect the PCR-WE/WE2 to a PC through a LAN. For details, see the Communication Interface Manual (in the included CD-ROM).

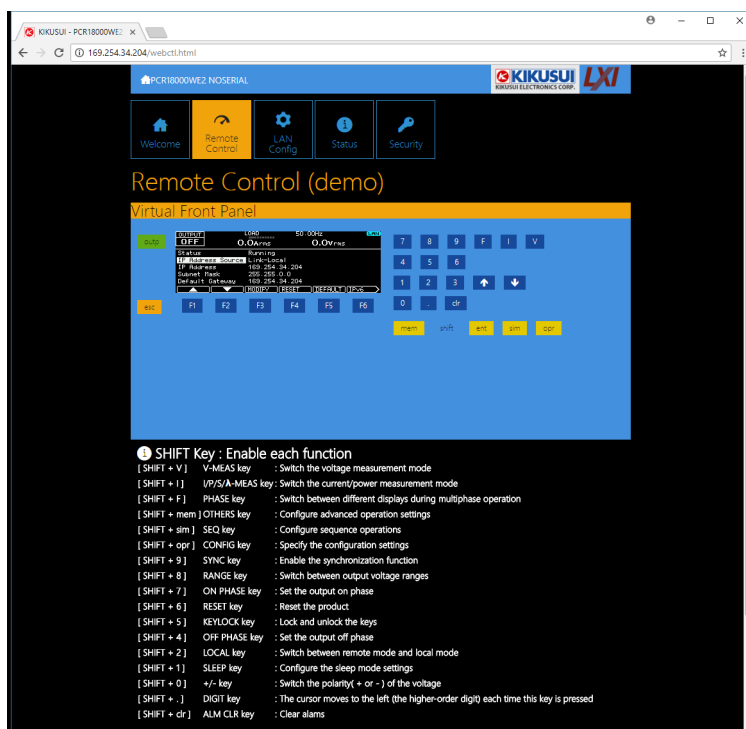

Displaying SCPI Errors

You can check the content of the SCPI error when an SCPI error occurs during remote control.

Up to 16 errors are displayed. If the 17th error occurs, the 16th error changes to “-350 Queue overflow,” and subsequent errors are not displayed.

For details on errors, see the Communication Interface Manual on the included CD-ROM.

Press CONFIG (SHIFT+OPR MODE) > COM-I/F (F1) > ERROR (F5) to display SCPI errors.

Parameter	Description
SUMMARY(F3)	Displays the SCPI error summary
DETAIL(F4)	Displays the SCPI error details
REFRESH(F5)	Updates to the latest error

Pressing Clear or restarting the PCR-WE will clear the error.

Factory Default Settings and Reset Settings

On this product, you can return all the settings to their factory default conditions or return just a portion of the settings to their factory default conditions.

- Returning all settings to their factory defaults (sanitize)

Press CONFIG (SHIFT+OPR MODE) > 1/3 (F6) > SANITIZE (F4) > EXEC (F5) > OK (F4).

The PCR-WE will restart with the factory default settings.

When parallel operation in use, set the rotary switches for the address and the number of slave units on the master unit and all slave units to zero, and then sanitize the PCR-WEs.

- Returning the panel setting of the output method to its factory default condition (reset)

Press RESET (SHIFT+6).

For example, assume that the output method is set to single-phase output and the AC voltage (panel setting) is set to 100 V. Change the output method to three-phase output and the AC voltage to 50 V. Pressing RESET (SHIFT+6) causes the AC voltage to be reset to 0 V. With reset, only the panel setting of the present output method is reset. Therefore, if you change the output method to single-phase output, the AC voltage will remain at the previous 100 V setting.

With reset, only the panel settings are reset to their factory default conditions, nothing else.

■ Settings of each output method

For parameters with “Yes” marked in the output method column, there is a separate setting for each output method (single-phase output, single-phase three-wire output, three-phase output).

Parameter	Output method
system settings	No
Panel settings	Yes
Setup memory	Yes
Waveform bank data	No
Power line abnormality simulations	Yes
Sequence function	Yes

Factory default settings

■ system settings

Settings are not returned to their factory default conditions even when the product is reset. The settings apply to all output methods.

Parameter	Factory default	
Output method*1	Three-phase output	
Key lock	Off	
Date and time	Auto clock adjustment	On
	Sets the NTP server.	ntp.nict.jp
	Time zone	UTC
RS232C settings	Enabled	
	Baud rate	19200 bps
LAN configuration	Enabled	
	IP address assignment method	Automatic.
USB	Enabled	
GPIB (option)	Enabled	
Voltage surge suppression	On	
Voltage offset	0	
Screen brightness	3	
Panel setting state when the POWER switch is turned on	AUTO	
Watchdog protection	Disabled, 60 s	
External clock (factory option)	Internal	

*1. PCR-WE2 only

• External digital I/O

Parameter	Factory default		
CTRL.1 to CTRL.4	Enabled/disabled (for each channel)	Disabled	
	Signal to control	CTRL.1	Output Control
		CTRL.2	SEQ Execution Control
		CTRL.3	Alarm Clear
	Polarity (for each channel)	POS	
STAT.1 to STAT.4	Enabled/disabled (for each channel)	Disabled	
	Signal to control	STAT.1	SEQ Status out
		STAT.2	Output ON Status
		STAT.3	Busy Status
	Polarity (for each channel)	HIGH	
DIO.1/ DIO.2	Enabled/disabled (for each channel)	Disabled	
	Signal to control	DIO.1	When INP.SIG is selected: Sync Clock In When OUTP.SIG is selected: SEQ Trigger Out
		DIO.2	When INP.SIG is selected: SEQ Trigger In When OUTP.SIG is selected: Standard Clock Out
	Polarity (for each channel)	HIGH	

■ Panel settings

Settings are returned to their factory default conditions even when the product is reset. There is a separate setting for each output method.

Parameter	Factory default									
	PCR 1000WE	PCR 2000WE	PCR 3000WE2	PCR 6000WE2	PCR 12000WE2	PCR 18000WE2	PCR 24000WE2	PCR 30000WE2	PCR 36000WE2	
Frequency	50.00 Hz									
AC voltage	0.0 V									
DC voltage	0.0 V									
Output condition when the POWER switch is turned on	SAFE									
Output voltage range	L									
Upper AC voltage limit	315.0 V									
Lower AC voltage limit	0.0 V									
Upper DC voltage limit	445.0 V									
Lower DC voltage limit	-445.0 V									
Upper frequency limit	5000 Hz (500 Hz on the 500 Hz limit model)									
Lower frequency limit	1.00 Hz									
AC current limit	1P output	11.0 A	22.0 A	33.0 A	66.0 A	132.0 A	198.0 A	264.0 A	330.0 A	396.0 A
	1P3W output	—	—	11.0 A	22.0 A	44.0 A	66.0 A	88.0 A	110.0 A	132.0 A
	3P output									
Positive current peak limit	1P output	42.0 A	84.0 A	126.0 A	252.0 A	504.0 A	756.0 A	1008.0 A	1260.0 A	1512.0 A
	1P3W output	—	—	42.0 A	84.0 A	168.0 A	252.0 A	336.0 A	420.0 A	504.0 A
	3P output									
Negative current peak limit	1P output	-42.0 A	-84.0 A	-126.0 A	-252.0 A	-504.0 A	-756.0 A	-1008.0 A	-1260.0 A	-1512.0 A
	1P3W output	—	—	-42.0 A	-84.0 A	-168.0 A	-252.0 A	-336.0 A	-420.0 A	-504.0 A
	3P output									
Current limit operation	TRIP									
Current limit trip time	10 s									
Output overvoltage protection (OVP)	489.5 V									
Positive peak OVP	489.5 V									
Negative peak OVP	-489.5 V									
Output undervoltage protection (UVP)	0.0 V, not judged									
Sync function	Off, 0.0 deg, synchronizes to the input power supply									
Output-on phase	Phase control disabled, 0.0 deg									
Output-off phase	Phase control disabled, 0.0 deg									
U-V phase difference	—	—	120.00°							
U-W phase difference	—	—	240.00°							
Number of the waveform bank to execute	0 (sine wave)									
Number of the waveform bank to edit	1									
Soft start	Off, 0.1 s									
Soft stop	Off, 0.1 s									
Response	MEDIUM									
Compensation	Off, regulation adjustment correction value: 0									
Output impedance	Off, 0 mΩ, 0 μH									

Parameter		Factory default									
		PCR 1000WE	PCR 2000WE	PCR 3000WE2	PCR 6000WE2	PCR 12000WE2	PCR 18000WE2	PCR 24000WE2	PCR 30000WE2	PCR 36000WE2	
Panel display	Phase	—	—	All (Phase voltage display)							
	Voltage	Rms voltage									
	Current, power, power factor	Rms current									
Peak voltage hold time		0 s									
Peak current hold time		0 s									
Measurement average	Voltage	1									
	Current, power, power factor	1									
Sleep function		OFF, 60 min									
AC coupling		Disabled									
Harmonic analysis		Current, all harmonics									
Maximum expected power		—	—	—	—	12000 VA	18000 VA	24000 VA	30000 VA	36000 VA	
Preset memory recall		Confirm and recall									
Preset memory (all memories A, B, and C)	AC voltage	0.0 V									
	DC voltage	0.0 V									
	Frequency	50.00 Hz									
	Waveform bank number	0									

- External analog input

Parameter	Factory default
External analog signal	Not use

■ Setup memory

Settings are not returned to their factory default conditions even when the product is reset. There is a separate setting for each output method.

Panel settings are saved. For details on the settings, see the factory default setting of each parameter.

■ Waveform bank

Settings are not returned to their factory default conditions even when the product is reset. The settings apply to all output methods.

Parameter	Factory default
Waveform type	Sine
User-defined waveform (set only from remote control)	Sine
Crest factor	1.40
Clip factor	1.0

■ Power line abnormality simulations

Settings are not returned to their factory default conditions even when the product is reset. There is a separate setting for each output method.

Parameter	Factory default
T1 setting unit	Hours
Voltage regulation polarity	Positive
T5 setting unit	Hours
Regulated voltage T3	0.0 V
Repetition count	9999 (infinity)
T1 time	100.0 ms
T1 angle	0.0 deg
T2 time	0 ms
T3 time	100.0 ms
T4 time	0 ms
T5 time	100 ms
T5 return cycles	0

■ Sequence function

Settings are not returned to their factory default conditions even when the product is reset. There is a separate setting for each output method.

- Sequence condition settings

Parameter	Factory default
Starting step number	0
Ending step number	599
Repetition count	1

- Step settings (all steps)

Parameter	Factory default
AC voltage	0.0 V, ramp off
Frequency	50.00 Hz, ramp off
DC voltage	0.0 V, ramp off
Jump type	Next step
Jump destination step	0
Number of jump repetitions	1
Output impedance	Off, 0 mΩ, 0 μH
Execution time	10 ms
waveform bank number	0
Output	On
Status output	On
Trigger output	Off
Trigger input	Off
Start phase	Free, 0.0 deg
End phase	Free, 0.0 deg
Sudden phase change	Off
U phase offset	Off, 0.00 deg, ramp off
UV phase difference	Off, 120.00 deg, ramp off
UW phase difference	Off, 240.00 deg, ramp off

Updating

You can update the PCR-WE firmware by using a USB memory device.

If there is an update, you can obtain it from the download service on the Kikusui website (<http://www.kikusui.co.jp/en/download/>).

NOTE Save the update files (Update.img, CHECKSUM.md5) in the root directory of the USB memory device. Do not change the names of the update files.

After updating, you need to sanitize the PCR-WE. Sanitizing the PCR-WE returns the present settings to their factory default conditions. Before updating, we recommend that you save the PCR-WE's settings in a USB memory device ([p. 79](#)).

- 1** Press **CONFIG (SHIFT+OPR MODE) > 1/3 (F6) > UPDATE (F5)**.
- 2** Insert a USB memory device containing the update file into the USB port on the PCR-WE front panel.
- 3** Press **EXEC (F5) > OK (F4)**.
Do not turn off the POWER switch or remove the USB memory device while updating is in progress.
- 4** When the update is complete, remove the USB memory device.
- 5** Press **CONFIG (SHIFT+OPR MODE) > 1/3 (F6) > SANITIZE (F4)**.
- 6** Press **EXEC (F5) > OK (F4)**.
The PCR-WE will restart with the factory default settings.
- 7** Check that the updated firmware version is the default version.
The default version is the version indicated for the update file on the Kikusui Electronics Corporation website.
Updating is complete.

After updating, use the PCR-WE manual that corresponds to the updated version. Download the corresponding manual from the Kikusui Electronics Corporation website.

If your PCR-WE doesn't start even though you followed the procedure written here or if there are any items that are not clear, contact your Kikusui agent or distributor.

Maintenance

Cleaning the Dust Filter

A dust filter is installed on the inside of the louver on the front panel. Periodically clean the filter to prevent clogging.

NOTE

- If the dust filter is clogged, the product's internal cooling capabilities will be reduced. This may lead to malfunction or the reduction of the product's service life.
- Dry the dust filter completely before attaching it. If moisture is present in the dust filter, the temperature or humidity inside the PCR-WE increases and may cause malfunctions.

1 Detach all the louvers from the panel.

While using your fingers to push the lock lever under the detachment mark up, slide the entire louver to the right, and then pull the louver towards you to detach it.

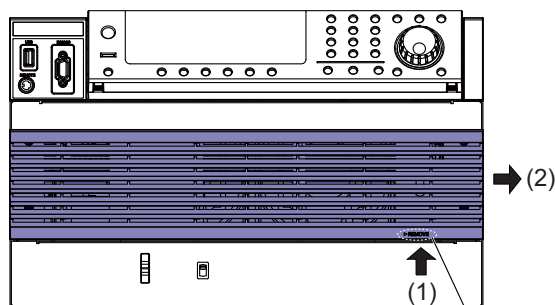

Detachment mark

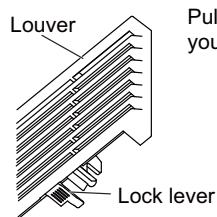

Pull up on the lock lever under the detachment mark with your fingertips (1), and slide the louver to the right (2)

2 Remove the dust filter from the inside of the louver.

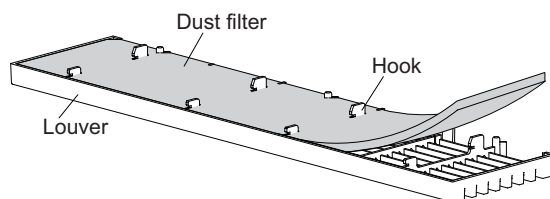

3 Clean the dust filter.

Use a vacuum cleaner to dispose of the dust and foreign particles that are attached to the dust filter. If the filter is extremely dirty, clean it using water-diluted neutral detergent, and dry it completely.

4 Attach the dust filter to the louver.

The dust filter has a top side and a bottom side. The side that has sections cut out of it is the bottom side. Firmly attach the dust filter so that the louver's tabs protrude out of the top of the dust filter.

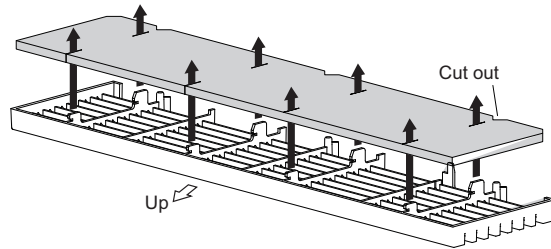

5 Check the top and bottom parts of the louvers, and then attach all of them to the product.

Align the lock lever with the lock lever insertion hole. Align the hooks on the inside of the louver with the corresponding holes on the panel, and then slide the louver to the left to attach it.

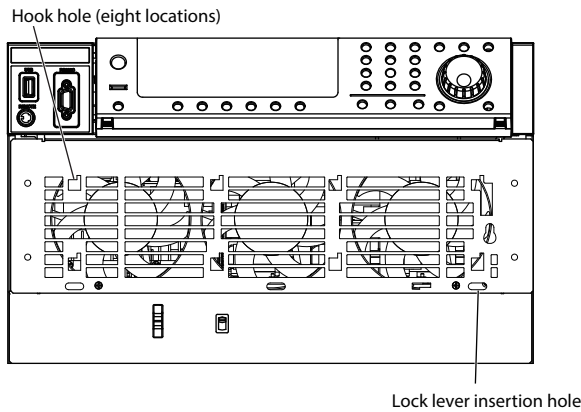

Backup Battery Replacement

The product has a battery inside. The battery's service life differs depending on the environment that the product is used in, but three years after it is purchased is a rough estimate for the battery's service life. When the battery is exhausted, the time becomes inaccurate. For information about replacing the battery, contact your Kikusui agent or distributor.

Calibration

The product is calibrated before shipment. To maintain long-term performance, we recommend periodic calibration.

To have your product calibrated, contact your Kikusui agent or distributor.

Specifications

Main Unit Specifications

Unless specified otherwise, the specifications are for the following settings and conditions.

- The warm-up time is 30 minutes (with current flowing).
- TYP: These are typical values that are representative of situations where the product operates in an environment with an ambient temperature of 23 °C. These values do not guarantee the performance of the PCR-WE/WE2.
- setting: Indicates a setting.
- reading: Indicates the readout value.
- f.s: Indicates full scale.
- For the PCR6000WE2R, read “PCR6000WE2” as “PCR6000WE2R” in this document.
For the PCR12000WE2R, read “PCR12000WE2” as “PCR12000WE2R” in this document.
For the PCR18000WE2R, read “PCR18000WE2” as “PCR18000WE2R” in this document.
For the PCR24000WE2R, read “PCR24000WE2” as “PCR24000WE2R” in this document.
For the PCR30000WE2R, read “PCR30000WE2” as “PCR30000WE2R” in this document.
For the PCR36000WE2R, read “PCR36000WE2” as “PCR36000WE2R” in this document.

Input (AC rms)

		Single-phase output			Single-phase/three-phase switchable model					
		PCR 1000WE	PCR 2000WE	PCR 3000WE2	PCR 6000WE2	PCR 12000WE2	PCR 18000WE2	PCR 24000WE2	PCR 30000WE2	PCR 36000WE2
Voltage (nominal)	1P2W input model	100 Vrms to 120 Vrms, 200 Vrms to 240 Vrms ^{*1}			—					
	3P3W input model	—			200 Vrms to 240 Vrms (3 phase line voltage)					
	3P4W input model	—			380 Vrms to 480 Vrms (3 phase line voltage)					
Voltage (allowable variation range)	1P2W input model	85 Vrms to 132 Vrms, 170 Vrms to 250 Vrms ^{*1}			—					
	3P3W input model	—			170 Vrms to 250 Vrms (3 phase line voltage)					
	3P4W input model	—			323 Vrms to 519 Vrms (3 phase line voltage)					
Frequency (nominal)		50 Hz to 60 Hz								
Frequency (allowable variation range)		45 Hz to 65 Hz								
Apparent power		1.4 kVA or less	2.7 kVA or less	4 kVA or less	7.8 kVA or less	15.6 kVA or less	23.4 kVA or less	31.2 kVA or less	39 kVA or less	46.8 kVA or less
Power factor ^{*2}	1P2W input model	0.95 (TYP)			—					
	3P3W input model	—			0.97 (TYP)					
	3P4W input model	—			0.95 (TYP)					
Maximum current ^{*3}	1P2W input model	17 A/ 8.5 A	32 A/ 16 A	48 A/ 24 A	—					
	3P3W input model	—			27 A	53 A	80 A	106 A	133 A	159 A
	3P4W input model	—			14 A	28 A	42 A	56 A	70 A	84 A
Hold-up time for power interruption ^{*2}		10 ms								
Protective conductor current ^{*4}	1P2W input model	3.5 mA or less			—					
	3P3W input model	—			10 mA or less	15 mA or less	20 mA or less	25 mA or less	30 mA or less	35 mA or less
	3P4W input model	—			3.5 mA or less					

*1. 100 V/200 V input system (auto select)

*2. At output voltage 100 V/200 V, rated output current, sine wave, load power factor 1, output frequency 40 Hz to 1 kHz

*3. Current at the minimum voltage (within the allowable variation range)

*4. At output voltage 100 V/200 V, rated output current, sine wave, load power factor 1, output frequency 45 Hz to 65 Hz

Regeneration function

The models in the following table have a regeneration function.

		PCR 6000WE2R	PCR 12000WE2R	PCR 18000WE2R	PCR 24000WE2R	PCR 30000WE2R	PCR 36000WE2R
Maximum regenerated power*1		6 kVA	12 kVA	18 kVA	24 kVA	30 kVA	36 kVA
Maximum reverse power flow current *1 *2	1P2W	60 A/ 30 A	120 A/ 60 A	180 A/ 90 A	240 A/ 120 A	300 A/ 150 A	360 A/ 180 A
	1P3W 3P	20 A/ 10 A	40 A/ 20 A	60 A/ 30 A	80 A/ 40 A	100 A/ 50 A	120 A/ 60 A
Regeneration efficiency*3		85 % (TYP)					
Output current harmonic distortion		THD: 5 % or less, each harmonic: 3 % or less (2nd to 40th)					

- *1. When the output phase voltage is between 100 Vac and 157.5 Vac or 200 Vac and 315 Vac, the output current is reduced by the output voltage. When the output frequency is between 1 Hz and 40 Hz, the output current is reduced by the output frequency. The output current is 70 % at 1 Hz.
- *2. When the output voltage is 100 V or 200 V and the signal is DC or the output frequency is between 40 Hz and 1 kHz (when the current phase is -90 deg to -180 deg or 90 deg to 180 deg relative to the output voltage)
- *3. At output voltage 100 V/200 V, rated output current, sine wave, load power factor 1, DC or output frequency 45 Hz to 65 Hz

Output

	Single-phase output		Single-phase/three-phase switchable model						
	PCR 1000WE	PCR 2000WE	PCR 3000WE2	PCR 6000WE2	PCR 12000WE2	PCR 18000WE2	PCR 24000WE2	PCR 30000WE2	PCR 36000WE2
Maximum peak current ^{*1}	4 times the maximum output current								
Inrush current capacity ^{*2}	Current at 3 times the maximum output current for 0.07 s			Current at 1.4 times the maximum output current for 0.5 s					
Efficiency ^{*3}	82 % (TYP)			85 % (TYP)					

*1. Repeated output is possible when the crest factor is 4.

*2. At an ambient temperature of 23 °C±5 °C.

*3. At output voltage 100 V/200 V, rated output current, sine wave, load power factor 1, output frequency 40 Hz to 1 kHz

■ AC voltage

		Single-phase output		Single-phase/three-phase switchable model						
		PCR 1000WE	PCR 2000WE	PCR 3000WE2	PCR 6000WE2	PCR 12000WE2	PCR 18000WE2	PCR 24000WE2	PCR 30000WE2	PCR 36000WE2
AC voltage ^{*1}	Rating	155 V / 310 V ^{*2}								
	Setting range	0 V to 157.5 V, 0 V to 315.0 V								
	Resolution	0.1 V								
	Setting accuracy ^{*3 *4}	Phase voltage: ±(0.3 % of setting + 0.3 V), ±(0.3 % of setting + 0.6 V) Line voltage: ±(0.3 % of setting + 0.3 V), ±(0.3 % of setting + 0.6 V) ^{*5}								
Maximum current ^{*1 *6}	Single-phase output	10 A / 5 A	20 A / 10 A	30 A / 15 A	60 A / 30 A	120 A / 60 A	180 A / 90 A	240 A / 120 A	300 A / 150 A	360 A / 180 A
	Single-phase three-wire output	—		10 A / 5 A	20 A / 10 A	40 A / 20 A	60 A / 30 A	80 A / 40 A	100 A / 50 A	120 A / 60 A
	Three-phase output	—		—	—	—	—	—	—	—
Phase	1P		1P2W, 1P3W, 3P4W switchable							
Power capacity	Single-phase output	1 kVA	2 kVA	3 kVA	6 kVA	12 kVA	18 kVA	24 kVA	30 kVA	36 kVA
	3P output	—		3 kVA	6 kVA	12 kVA	18 kVA	24 kVA	30 kVA	36 kVA
	Single-phase three-wire output	—		2 kVA	4 kVA	8 kVA	12 kVA	16 kVA	20 kVA	24 kVA
Load power factor	0 to 1 (leading or lagging)									
Frequency	Setting range	1 Hz to 5 kHz ^{*7} (5 kHz -3dB, <40 Hz derating required)								
	Resolution	0.01 Hz (1.00 Hz to 100.0 Hz), 0.1 Hz (100.0 Hz to 1000 Hz), 1 Hz (1000 Hz to 5000 Hz)								
	Setting accuracy	±0.01 % ^{*3} , temperature coefficient: ±0.005 %/°C								
Phase	Resolution	—		0.1° (1 Hz to 500 Hz), 1° (500 Hz to 4 kHz), 2° (4 kHz or more)						
	Setting accuracy ^{*3}	—		Within 120° ± (0.4°+2.5 μs) ^{*8} Within (120° ± (0.4° + fo×0.9×10 ⁻³)) fo: frequency [kHz]						

*1. Output L range, H range

*2. The spec guaranteed voltage range is 1 V to 155 V and 2 V to 310 V.

*3. At an ambient temperature of 23 °C±5 °C.

*4. At no load, output frequency 45 Hz to 65 Hz

*5. At the phase angle of 120° of each phase

*6. When the output voltage is between 100 Vac and 155 Vac or 200 Vac and 310 Vac, the output current is reduced by the output voltage. When the output frequency is between 1 Hz and 40 Hz, the output current is reduced by the output frequency. The output current is 70 % at 1 Hz.

*7. On the 500 Hz limit model, the frequency is limited to 1 Hz to 500.0 Hz for three-phase output.

*8. Example in which angle conversion is performed at a given frequency, within 120° ± 0.5° (at 60 Hz output), within 120° ± 0.8° (at 400 Hz output)

■ DC voltage

		Single-phase output		Single-phase/three-phase switchable model						
		PCR 1000WE	PCR 2000WE	PCR 3000WE2	PCR 6000WE2	PCR 12000WE2	PCR 18000WE2	PCR 24000WE2	PCR 30000WE2	PCR 36000WE2
DC voltage	Rating* ¹	-219 V to +219 V, -438 V to +438 V* ²								
	Setting range* ¹	-222.5 V to +222.5 V, -445.0 V to +445.0 V								
	Resolution	0.1 V								
	Setting accuracy* ³	±(0.05 % of setting + 0.1 V)								
Maximum current* ⁴		10 A / 5 A	20 A / 10 A	30 A / 15 A	60 A / 30 A	120 A / 60 A	180 A / 90 A	240 A / 120 A	300 A / 150 A	360 A / 180 A
Power capacity		1 kW	2 kW	3 kW	6 kW	12 kW	18 kW	24 kW	30 kW	36 kW

- *1. Output L range, H range
- *2. The spec guaranteed voltage range is 1.4 Vdc to 219 Vdc, 2.8 Vdc to 438 Vdc.
- *3. At no load, 23 °C±5 °C.
- *4. When the output voltage is between 100 Vdc and 200 Vdc or 219 Vdc and 438 Vac, the output current is reduced by the output voltage.

Output voltage stability (phase voltage)

At an ambient temperature of 23 °C±5 °C

	PCR 1000WE	PCR 2000WE	PCR 3000WE2	PCR 6000WE2	PCR 12000WE2	PCR 18000WE2	PCR 24000WE2	PCR 30000WE2	PCR 36000WE2
Line regulation* ¹	Within ±0.1 %								
Load regulation* ²	Within ±0.1 V/±0.2 V (1 Hz to 100 Hz) Within ±0.3 V/±0.6 V (100.1 Hz to 500 Hz) Within ±1 V/±2 V (500.1 Hz to 1 kHz)					Within ±0.2 V/±0.4 V (1 Hz to 100 Hz) Within ±0.3 V/±0.6 V (100.1 Hz to 500 Hz) Within ±1 V/±2 V (500.1 Hz to 1 kHz)			
Variation according to output frequency* ³	When the output voltage correction function is enabled: within ±0.3 % (1 Hz to 1 kHz), within ±10 % (1001 Hz to 5 kHz) When the output voltage correction function is disabled: ≤ -3 dB (5 kHz)								
Ripple noise* ⁴	≤ 0.25 Vrms				≤ 0.3 Vrms	≤ 0.4 Vrms	≤ 0.5 Vrms	≤ 0.6 Vrms	≤ 0.7 Vrms
Temperature coefficient* ⁵	100ppm/°C (TYP)								
Total harmonic distortion* ⁶	0.3 % or less (1 Hz to 100 Hz), 0.5 % or less (100.1 Hz to 330 Hz), 1.5 %/kHz or less (330.1 Hz to 5 kHz)								
Transient response* ⁷	Response FAST: 55 μs (TYP)								
Response speed Tr/Tf* ⁸	Response FAST: 55 μs (TYP) Response MEDIUM: 100 μs (TYP) Response SLOW: 300 μs (TYP)								

- *1. For input voltage changes within the rated range
- *2. For output current changes within 0 to 100 % of the rating
Output L range, H range
When the output phase voltage is between 80 V and 155 V or 160 V and 310 V, the load power factor is 1, and the response is FAST At the output terminal block.
When the compensation function is not used
- *3. Voltage variation over 40 Hz to 5 kHz in AC mode with 55 Hz as the reference
When the output phase voltage is between 80 V and 155 V or 160 V and 310 V, the load power factor is 1, and the response is FAST At the output terminal block.
- *4. 5 Hz to 1 MHz components in DC mode
- *5. For changes within the operating temperature range
At output phase voltage 100 V/200 V, no load
- *6. When the output phase voltage is between 80 V and 155 V or 160 V and 310 V, the load power factor is 1, and the response is FAST At the output terminal block.
- *7. When the output voltage is 100 V or 200 V, the load power factor is 1, and the output current changes from 0 A to the rated value and from the rated value to 0 A.
- *8. At 10 % to 90 % of the output voltage

Measurement

		Single-phase output		Single-phase/three-phase switchable model						
		PCR 1000WE	PCR 2000WE	PCR 3000WE2	PCR 6000WE2	PCR 12000WE2	PCR 18000WE2	PCR 24000WE2	PCR 30000WE2	PCR 36000WE2
Voltage Rms value	Resolution	0.1 V								
	Accuracy ^{*1}	DC, 40 Hz to 999.9 Hz: $\pm(0.3\%$ of reading + 1 V) 1 kHz to 5 kHz: $\pm(0.5\%$ of reading + 1 V)								
Current Rms value	Resolution	0.01 A			0.1 A					
	Accuracy ^{*1 *2}	45 Hz to 65 Hz: $\pm(0.3\%$ of reading + 0.3 % of f.s) DC, 40 Hz to 999.9 Hz: $\pm(0.6\%$ of reading + 0.6 % of f.s) 1 kHz to 5 kHz: $\pm(1.2\%$ of reading + 1.2 % of f.s)								
Current Peak value	Resolution	0.01 A			0.1 A			1 A		
	Accuracy ^{*1 *3}	4 % of f.s								
Active power	Resolution	1 W			10 W					
	Accuracy ^{*1, *2 *4}	45 Hz to 65 Hz: $\pm(0.3\%$ of reading + 0.3 % of f.s)								
Apparent power	Resolution	1 VA			10 VA					
Power factor	Resolution	0.01								
Phase difference	Resolution	0.1°								
Harmonic measurement	Frequency range (funda- mental wave)	10 Hz to 1 kHz								
	Upper limit of harmonic analysis	5th to 50th								
	FFT data length	4096								
	Measurement items	Rms voltage and current, phase angle, THD								
Recommended calibration period	1 year									

*1. At an ambient temperature of 23 °C \pm 5 °C.

*2. At 10 % to 100 % of maximum rated current, sine wave

*3. Pulse height of sine wave

*4. At a power factor of 1

Limit values and protection functions

		Setting range	Resolution	
Voltage protection	Upper AC voltage limit Lower AC voltage limit	0.0 V to 315.0 V	0.1 V	
	Upper DC voltage limit Lower DC voltage limit	-445.5 V to 445.5 V	0.1 V	
	Output overvoltage protection (OVP)	Rms value	14.0 V to 489.5 V	0.1 V
		Positive peak value	14.0 V to 489.5 V	0.1 V
		Negative peak value	-489.5 V to -14.0 V	0.1 V
	Power module overvoltage protection	Fixed	—	
Output undervoltage protection (UVP)	0.0 V to 489.5 V	0.1 V		
Frequency protection	Upper frequency limit Lower frequency limit	1 Hz to 5000 Hz 1 Hz to 500 Hz on the 500Hz LMT model (for three-phase output)	0.01 Hz (1.00 Hz to 100.0 Hz), 0.1 Hz (100.0 Hz to 1000 Hz), 1 Hz (1000 Hz to 5000 Hz)	
Current protection	Current limit*1	Maximum output current × 0.1 to maximum output current × 1.1	0.01 A (0.35 A to 100.0 A), 0.1 A (100.0 A to 1000 A)	
	Positive peak current limit Negative peak current limit*2	Maximum output current × 0.1 to maximum output current × 4.2		
Overheat protection	Power module overheat protection	Fixed	—	
	Fan error	Fixed	—	
Overload protection		Rated current or current limit	Current limit resolution	
Independent operation detection		Fixed	—	
System overvoltage, system undervoltage		Fixed	—	
System frequency increase, system frequency decrease		Fixed	—	
Sensing error detection		±(10 % +10 V) with respect to the output terminal voltage	—	

*1. The current that can actually be supplied is 1.1 times the rated current or the current limit, whichever is less.

*2. The current that can actually be supplied is the maximum peak current or the peak current limit, whichever is less.

Power line abnormality simulations

		Setting range	Resolution	Setting accuracy
T1	DEG	0 deg to 359.9 deg	0.1 deg	$\pm 1 \text{ deg } (\leq 1 \text{ kHz})^{*1}$
	TIME	0.0 ms to 999.9 ms	0.1 ms	$\pm(1 \times 10^{-3} + 0.1 \text{ ms})$
T2		0 ms to 99990 ms	1 ms	$\pm(1 \times 10^{-3} + 0.1 \text{ ms})$
T3		0.1 ms to 9999.0 ms	0.1 ms	$\pm(1 \times 10^{-3} + 0.1 \text{ ms})$
T4		0 ms to 99990 ms	1 ms	$\pm(1 \times 10^{-3} + 0.1 \text{ ms})$
T5/N	TIME	0 ms to 99990 ms	1 ms	$\pm(1 \times 10^{-3} + 0.1 \text{ ms})$
	CYCLE	0 cycles to 999 900 cycles	1 cycle	$\pm 1 \text{ cycle}$
T3 VOLT		The same as the output voltage setting range		
RPT		0 to 9 998 repetitions or infinite repetitions	1 repetition	$\pm 1 \text{ repetition}$

*1. Lag due to response speed not included.

Sequence operations

	Setting range	Resolution	Setting accuracy
STEP	0 to 599	1	—
FREQ	The same as the output frequency setting range		
ACV	The same as the output voltage setting range		
TIME	0.1 ms to 1 000 hours	0.1 ms	$\pm(1 \times 10^{-3} + 0.1 \text{ ms})$
W.B. No.	The same as the special waveform output setting range		
IMPEDANCE	The same as the output impedance setting range		
DCV	The same as the output voltage setting range		
PHASE	0.0 deg to 360.0 deg	0.1 deg	$\pm 1 \text{ deg } (\leq 1 \text{ kHz})^{*1}$

*1. Lag due to response speed not included.

Special waveform output

	Setting range	Resolution	Setting accuracy
Waveform bank (amplitude: 16 bit, 1 waveform: 4096 points)	0 to 256 (the waveform bank in 0 is read-only)	1	—
Crest factor	1.10 to 1.40	0.01	$\pm 0.01^{*1}$
Flat curve	0.4 to 1.0	0.1	—

*1. Crest factor of the generated waveform data

Output impedance setting

			Single-phase output		Single-phase/three-phase switchable model						
			PCR 1000WE	PCR 2000WE	PCR 3000WE2	PCR 6000WE2	PCR 12000WE2	PCR 18000WE2	PCR 24000WE2	PCR 30000WE2	PCR 36000WE2
L Range	Resistance component	1P	0 Ω to 2000 mΩ	0 Ω to 1000 mΩ	0 Ω to 667 mΩ	0 Ω to 333 mΩ	0 Ω to 167 mΩ	0 Ω to 111 mΩ	0 Ω to 83 mΩ	0 Ω to 67 mΩ	0 Ω to 56 mΩ
		1P3W 3P	—	—	0 Ω to 2000 mΩ	0 Ω to 1000 mΩ	0 Ω to 500 mΩ	0 Ω to 333 mΩ	0 Ω to 250 mΩ	0 Ω to 200 mΩ	0 Ω to 167 mΩ
	Reactance component	1P	80 μH to 2000 μH	40 μH to 1000 μH	27 μH to 667 μH	13 μH to 333 μH	7 μH to 167 μH	4 μH to 111 μH	3 μH to 83 μH	3 μH to 67 μH	2 μH to 56 μH
		1P3W 3P	—	—	80 μH to 2000 μH	40 μH to 1000 μH	20 μH to 500 μH	13 μH to 333 μH	10 μH to 250 μH	8 μH to 200 μH	7 μH to 167 μH
H Range	Resistance component	1P	0 Ω to 8000 mΩ	0 Ω to 4000 mΩ	0 Ω to 2667 mΩ	0 Ω to 1333 mΩ	0 Ω to 667 mΩ	0 Ω to 444 mΩ	0 Ω to 333 mΩ	0 Ω to 267 mΩ	0 Ω to 222 mΩ
		1P3W 3P	—	—	0 Ω to 8000 mΩ	0 Ω to 4000 mΩ	0 Ω to 2000 mΩ	0 Ω to 1333 mΩ	0 Ω to 1000 mΩ	0 Ω to 800 mΩ	0 Ω to 667 mΩ
	Reactance component	1P	320 μH to 8000 μH	160 μH to 4000 μH	107 μH to 2667 μH	53 μH to 1333 μH	27 μH to 667 μH	18 μH to 444 μH	13 μH to 333 μH	11 μH to 267 μH	9 μH to 222 μH
		1P3W 3P	—	—	320 μH to 8000 μH	160 μH to 4000 μH	80 μH to 2000 μH	53 μH to 1333 μH	40 μH to 1000 μH	32 μH to 800 μH	27 μH to 667 μH

Output on/off phase setting

	Setting range	Resolution	Setting accuracy
Phase angle setting	0.0 deg to 360.0 deg (0.0 deg = 360.0 deg)	0.1 deg	±1 deg (≤1 kHz)*1

*1. Lag due to response speed not included.

Communication interface

Software protocol	IEEE Std 488.2-1992
Command language	Complies with SCPI Specification 1999.0
USB	Complies with the USB 2.0 specifications; data rate: 480 Mbps (high speed), socket B type, self-powered
Message terminator	LF or EOM during reception, LF + EOM during transmission
Device class	Complies with the USBTMC-USB488 device class specifications
LAN	IEEE802.3, 100Base-TX Ethernet LXI Rev.1.5 2016 (Extended Functions: VXI-11, HiSLIP, IPv6), data rate: 100 Mbps (auto negotiation, Full Speed) AUTO MDIX function IPv4, RJ45 connector, category 5, straight cable
Communication protocol	VXI-11, HiSLIP, SCPI-RAW, SCPI-Telnet
Message terminator	VXI-11 and HiSLIP: LF or END during reception, LF + END during transmission SCPI-RAW: LF
RS232C	Complies with the EIA232D specifications, asynchronous full duplex, D-SUB 9-pin connector (male), crossover cable (null modem)
Baud rate	9600 bps/ 19200 bps/ 38400 bps/ 57600 bps/ 115200 bps
Data length	8 bits
Stop bits	1 bits
Parity	None (fixed)
Flow control	Xon/ Xoff
Message terminator	LF during reception, CR/LF during transmission
GPIB (option)	Complies with IEEE Std 488.1-1987 SH1, AH1, T8, L4, SR0, RL0, PP0, DC0, DT0, C0, E1 24-pin connector (receptacle)
Message terminator	LF or EOI during reception, LF + EOI during transmission
Primary address	1 to 30

Signal I/O

Insulation resistance	Between primary and terminals	500 Vdc, 10 MΩ or more
	Between secondary and terminals	500 Vdc, 10 MΩ or more
	Between input and output terminals	Non-isolated (shared common circuit)
Withstanding voltage	Between primary and terminals	1.5 kVac for 1 minute
	Between secondary and terminals	1.5 kVac for 1 minute
Isolation voltage		±42 Vpeak

Analog INPUT (ANALOG IN connector, Ch.A to Ch.C)

At an ambient temperature of 23 °C±5 °C

■ Analog input

Number of channels	3ch*1	
Terminal	DSUB 9-pin connector (female), #4-40 inch screws	
Input resistance	10 kΩ ±10 % (unbalanced)	
Maximum allowable input voltage	±12 V	
Control system selection	EXTDC mode: Amplifies the input waveform VPROG mode: Change the AC voltage, DC voltage, or frequency to output using a DC signal	
Input voltage range	±10 V	
Gain	Setting range	EXTDC mode: x5.00 to x220.00 VPROG mode: x5.00 to x50.00
	Resolution	0.01
offset	Adjustment range	±200 (equivalent to ±200 mV through input voltage conversion)
EXTDC mode	Response speed Tr/Tf*2	Main unit specifications + 50 μs (TYP)
	Output distortion	Main unit specifications + 0.2 % (0.1 % or less, when receiving sine wave) (TYP)
Output voltage error	±3.6 V (When gain and offset are at default values)	
Output voltage temperature coefficient	200 ppm/°C (TYP)	
Setting delay time	10 μs (TYP)	

*1. The common lines of the analog input signals, digital input signals, and selectable I/O signals are not isolated.

*2. At 10 % to 90 % of the output voltage

Digital I/O (DIGITAL IO connector)

Terminal	DSUB 9-pin connector (female), #4-40 inch screws
----------	--

■ Digital input (CTRL.1 to CTRL.4)

Number of channels		4ch (1ch is fixed input)*1
Input		The maximum open-circuit voltage across input pins is approximately 12 V, and the maximum short-circuit current is approximately 6.4 mA. The internal circuit is pulled up to 12 V by a 1.7 kΩ resistor. High-level input voltage: 11 V to 12 V, or open Low-level input voltage: 0 V to 1 V
Selectable input signals	DISABLE	No enabled functions
	Output Control	Output on/off
	SEQ Execution Control	Sequence run/stop
	Alarm Clear	Alarm clear
	External Alarm	External alarm input
	Wiring Control 1P	Output method change (single-phase)
	Wiring Control 1P3W	Output method change (single-phase three-wire)
	Wiring Control 3P	Output method change (three-phase)
	Volt Range	Output range change
	Recall A Memory	Preset memory A recall
	Recall B Memory	Preset memory B recall
	Recall C Memory	Preset memory C recall
	Output Inhibit	Output-on inhibit
Programmable Signal	Programmable signal in	
Fixed input signal	Shutdown	Shut down (fixed to positive logic)
Logical polarity		Invertible

*1. The common lines of the analog input signals, digital input signals, and selectable I/O signals are not isolated.

■ Digital output (STAT.1 to STAT.4)

Number of channels		4ch (1ch is fixed output)*1
Output		Photocoupler open collector output (30 Vdc, 8 mAmax)
Selectable output signals	DISABLE	No enabled functions
	Output ON Status	Output on status
	I Pk Limit Status	Peak current limit status
	Overload Status	Overload status
	Busy Status	Busy status
	Wiring 1P Status	Output method status (single-phase)
	Wiring 1P3W Status	Output method status (single-phase three-wire)
	Wiring 3P Status	Output method status (three-phase)
	Volt Range H Status	Output voltage H range status
	Power ON Status	POWER switch on status
	SEQ Status Out	Sequence/power line abnormality simulation status output
Fixed output signal	Alarm Status	Alarm status
Logical polarity		Invertible

*1. The common is separate for each channel. Keep the voltage across commons below 30 V.

■ Selectable I/O (DIO.1 to DIO.2)

Number of channels		2ch*1
Input	L level input voltage	0 V to 0.8 V
	H level input voltage	2 V to 5 V
Output	L level output voltage	0 V to 0.55 V
	H level output voltage	3.8 V to 5 V
	Maximum low-level sink current	12 mA
Selectable input signals	DISABLE	No enabled functions
	Sync Clock In	Output reference phase input
	SEQ Trigger In	Sequence trigger input
	Output Control	Output on/off
	SEQ Execution Control	Sequence run/stop
	Alarm Clear	Alarm clear
	External Alarm	External alarm input
	Wiring Control 1P	Output method change (single-phase)
	Wiring Control 1P3W	Output method change (single-phase three-wire)
	Wiring Control 3P	Output method change (three-phase)
	Volt Range	Output range change
	Recall A Memory	Preset memory A recall
	Recall B Memory	Preset memory B recall
	Recall C Memory	Preset memory C recall
	Output Inhibit	Output-on inhibit
Programmable Signal	Programmable signal in	
Selectable output signals	DISABLE	No enabled functions
	Standard Clock Out	Output reference phase output
	SEQ Trigger Out	Sequence trigger output
	Output ON Status	Output on status
	I Pk Limit Status	Current peak limit status
	Overload Status	Overload status
	Busy Status	Busy status
	Wiring 1P Status	Output method status (single-phase)
	Wiring 1P3W Status	Output method status (single-phase three-wire)
	Wiring 3P Status	Output method status (three-phase)
	Volt Range H Status	Output voltage H range status
	Power ON Status	POWER switch on status
	SEQ Status Out	Sequence/power line abnormality simulation status output
Programmable Signal	Programmable signal status	
Logical polarity		Invertible

*1. The common lines of the analog input signals, digital input signals, and selectable I/O signals are not isolated.

Parallel operation (PCR1000WE/ PCR2000WE/ PCR3000WE2 excluded)

Maximum number of units in parallel operation		N: (number of units in parallel operation) ≤ 4
I/O power (current) capacity ^{*1}		[Capacity of 1 PCR-WE]×N
Output voltage stability	Load regulation With respect to 0 % to 100 % variation in the rating	≤ ±0.5 V ^{*2}
	Variation according to output frequency For variation within the rated range	≤ ±1.2 % (≤ 1 kHz) ^{*2*3}
	Total harmonic distortion	≤ 0.5 % (≤ 100 Hz) ^{*2}
	Response speed	100 μs, 300 μs (TYP) ^{*4}
Ammeter, wattmeter		Displays the total value of parallel operation on the master unit ^{*5}

- *1. The maximum rating is limited to 48 kVA for single phase and 96 kVA for single-phase three-wire, regardless of the number of units in parallel.
- *2. Value at the OUTPUT terminal block of the master unit for output voltage 80 V to 150 V or 160 V to 300 V, load power factor 1
- *3. Voltage variation over 40 Hz to 5 kHz in AC mode with 55 Hz as the reference
- *4. At 10 % to 90 % of the output
- *5. The resolution varies depending on the output capacity during parallel operation.

Memory

- Internal memory
ABC memory (3 memories) and 10 setup memories
- USB memory device
Items that can be saved: Waveform bank data, internal memory, panel settings, power line abnormality simulation, sequence data

Sync function

Synchronizes the frequency and phase of the product's output voltage to the input power supply or external input clock (50 Hz or 60 Hz)

Compensation function

- Hard sensing
- Soft sensing
- Regulation adjustment

Response selection function

- High-speed response (FAST) mode
- Normal response (MED) mode
- High stability response (SLOW) mode

Ecological function

- Sleep function
- Power-saving function
- Power module management function

Soft start and soft stop functions

- Soft start
 - Rise time setting range: 0.1 to 30 s
- Soft stop
 - Fall time setting range: 0.1 to 3 s

LIN, DSI connection I/O

- Frequency clock (Phase_Clock): Open-collector output from a photocoupler
- Alarm signal input: Activates the alarm when a low level TTL signal is received.

General

		Single-phase output		Single-phase/three-phase switchable model						
		PCR 1000WE	PCR 2000WE	PCR 3000WE2	PCR 6000WE2	PCR 12000WE2	PCR 18000WE2	PCR 24000WE2	PCR 30000WE2	PCR 36000WE2
Insulation resistance	Between input and chassis, output and chassis, and input and output	500 Vdc, 10 MΩ or more								
Withstanding voltage	Between input and chassis, output and chassis, and input and output	1.5 kVac, 2.15 kVdc for 1 minute								
Isolation voltage		315 Vrms/ 445 Vdc								
Electromagnetic compatibility (EMC) ^{*1 *2}		Complies with the requirements of the following directive and standards. EMC Directive 2014/30/EU EN 61326-1 (Class A ^{*3}) EN 55011 (Class A ^{*3} , Group 1 ^{*4}) EN 61000-3-2 ^{*5} EN 61000-3-3 ^{*5} Applicable under the following conditions The maximum length of all cabling and wiring connected to the product must be less than 3 m.				Complies with the requirements of the following directive and standards. EMC Directive 2014/30/EU EN 61326-1 (Class A ^{*6}) EN 55011 (Class A ^{*3} , Group 1 ^{*7}) Applicable under the following conditions The maximum length of all cabling and wiring connected to the product must be less than 3 m.				
Safety ^{*1}		Complies with the requirements of the following directive and standards. Low Voltage Directive 2014/35/EU ^{*2} EN 61010-1 (Class I ^{*8} , Pollution Degree 2 ^{*9})								
Environmental conditions	Operating environment	Indoor use, overvoltage category II								
	Operating temperature range	0 °C to +50 °C (32 °F to +122 °F)								
	Storage temperature range	-10 °C to +60 °C (14 °F to +140 °F)								
	Operating humidity range	20 %rh to 80 %rh (no condensation).								
	Storage humidity range	90 %rh or less (no condensation).								
	Altitude	Up to 2000 m								
Dimensions (chassis)		See (p. 219).								
Weight		16 kg (35.3 lb)	20 kg (44.1 lb)	23 kg (50.7 lb)	43 kg ^{*10} (94.8 lb)	65 kg ^{*11} (143.3 lb)	120 kg (264.6 lb)	130 kg (286.6 lb)	160 kg (352.7 lb)	170 kg ^{*12} (374.8 lb)
Input terminal		M6			M5		200 V input model: M8 400 V input model: M5			
Output terminals		M6			M5		M6		M8	
Accessories		See (p. 3).								

*1. Does not apply to specially ordered or modified products.

*2. Only on models that have the CE marking on the panel.

*3. This is a Class A instrument. This product is intended for use in an industrial environment. This product may cause interference if used in residential areas. Such use must be avoided unless the user takes special measures to reduce electromagnetic emissions to prevent interference to the reception of radio and television broadcasts.

*4. This is a Group 1 instrument. This product does not generate and/or use intentionally radio-frequency energy, in the form of electromagnetic radiation, inductive and/or capacitive coupling, for the treatment of material or inspection/analysis purpose.

*5. Does not apply to the PCR6000WE2R.

*6. This is a Class A instrument. This product is intended for use in an industrial environment. This product may cause interference if used in residential areas. Such use must be avoided unless the user takes special measures to reduce electromagnetic emissions to prevent interference to the reception of radio and television broadcasts.

- *7. This is a Group 1 instrument. This product does not generate and/or use intentionally radio-frequency energy, in the form of electromagnetic radiation, inductive and/or capacitive coupling, for the treatment of material or inspection/analysis purpose.
- *8. This product conforms to Class I. Be sure to ground the protective conductor terminal of this product. If not grounded properly, safety is not guaranteed.
- *9. Pollution is addition of foreign matter (solid, liquid or gaseous) that may produce a reduction of dielectric strength or surface resistivity. Pollution Degree 2 assumes that only non-conductive pollution will occur except for an occasional temporary conductivity caused by condensation.
- *10. The PCR6000WE2R is 42 kg (92.6 lb).
- *11. The PCR12000WE2R is 66 kg (145.5 lb).
- *12. The PCR36000WE2R is 180 kg (396.8 lb).

Rated output current characteristics (derating)

The rated output current depends on the output conditions (output voltage, output frequency). The rated output current under given output conditions is the value obtained by converting the smaller of the two values: the output current ratio derived from fig. 1 (output voltage) or the output current ratio derived from fig. 2 (output frequency).

The output voltage ratio is a percentage where 100 % represents an output voltage of 100 V (output L range) or 200 V (output H range). The output current ratio is a percentage where 100 % represents the maximum rated output current.

Figure 1 Output voltage ratio vs. output current ratio

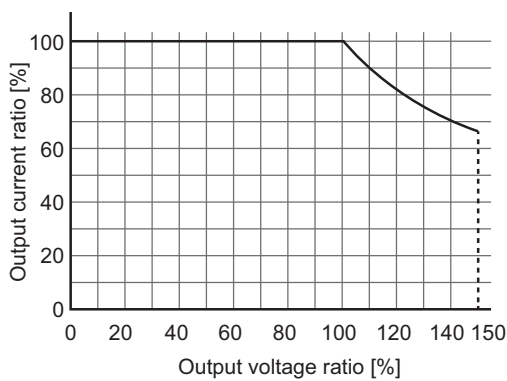
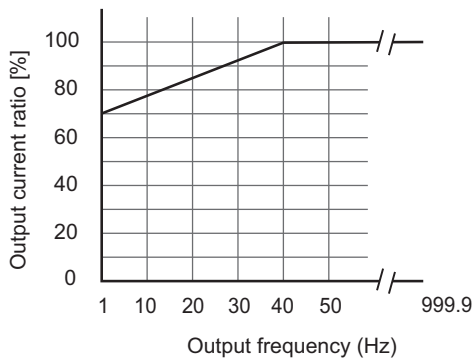

Figure 2 Output frequency vs. output current ratio



Outline Drawing

Unit: mm (inches)

■ PCR1000WE/ PCR2000WE/ PCR3000WE2

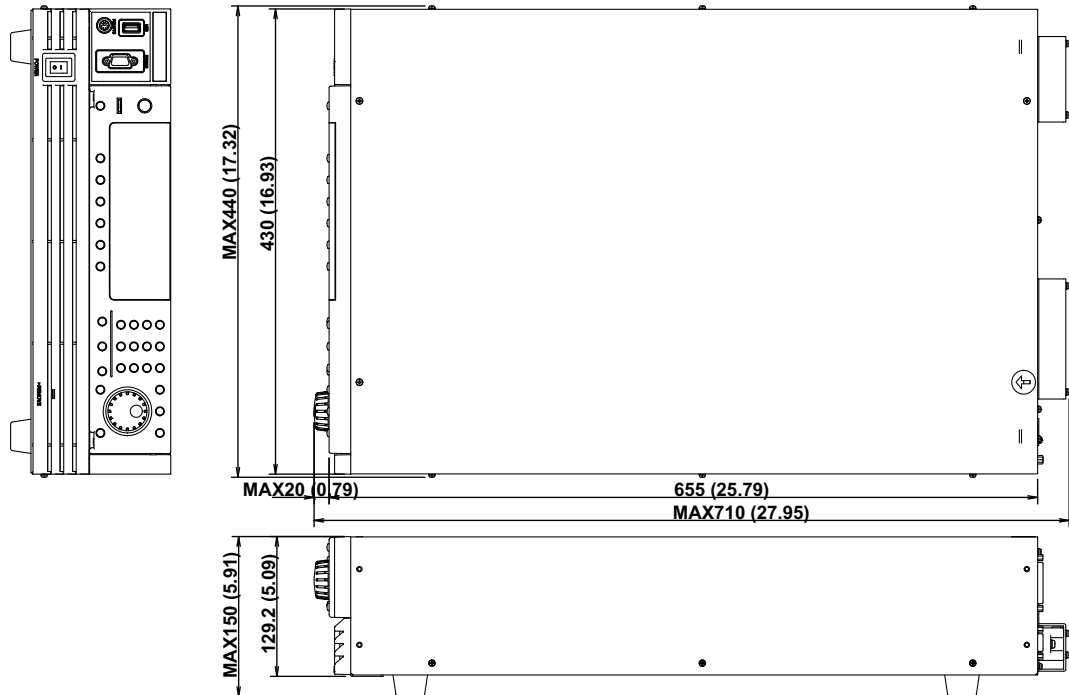

■ PCR6000WE2

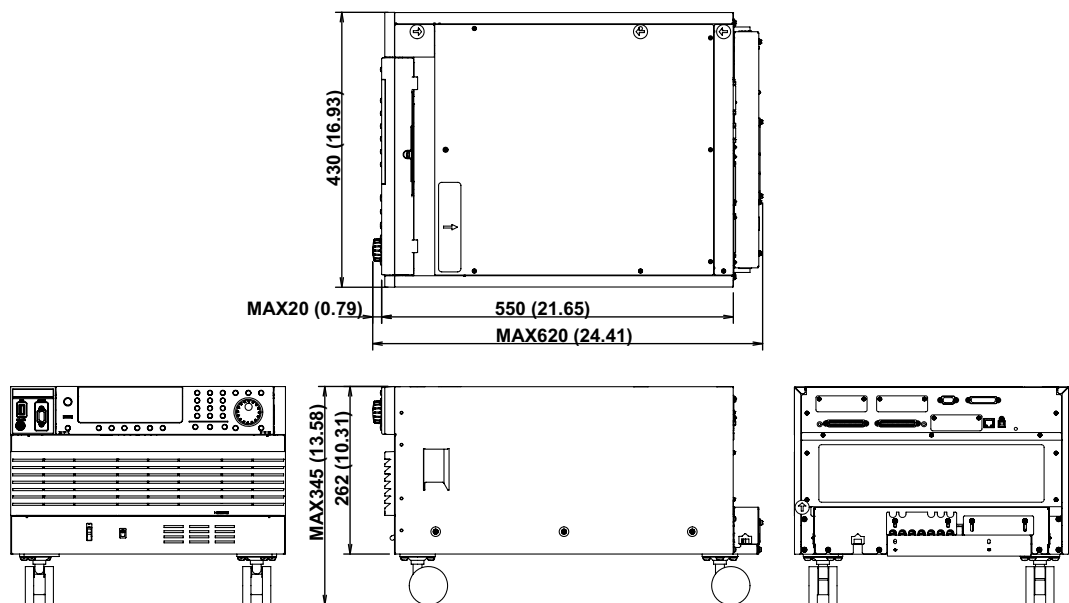

■ PCR12000WE2

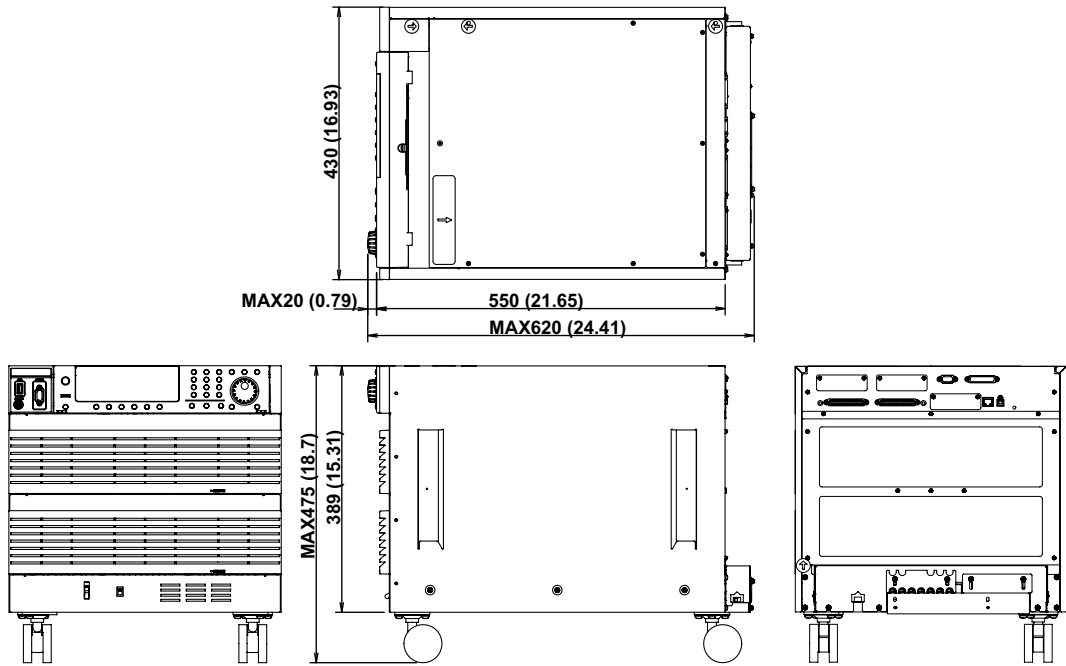

■ PCR18000WE2/ PCR24000WE2

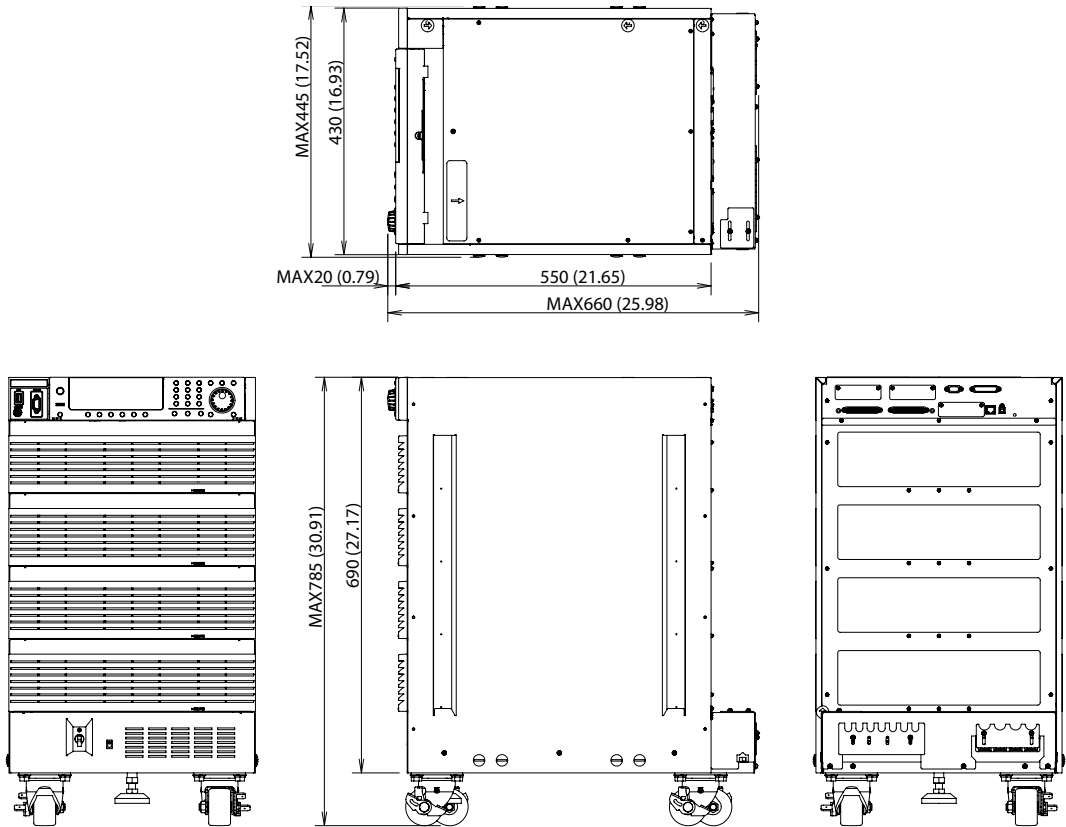

■ PCR3000WE2/ PCR3600WE2

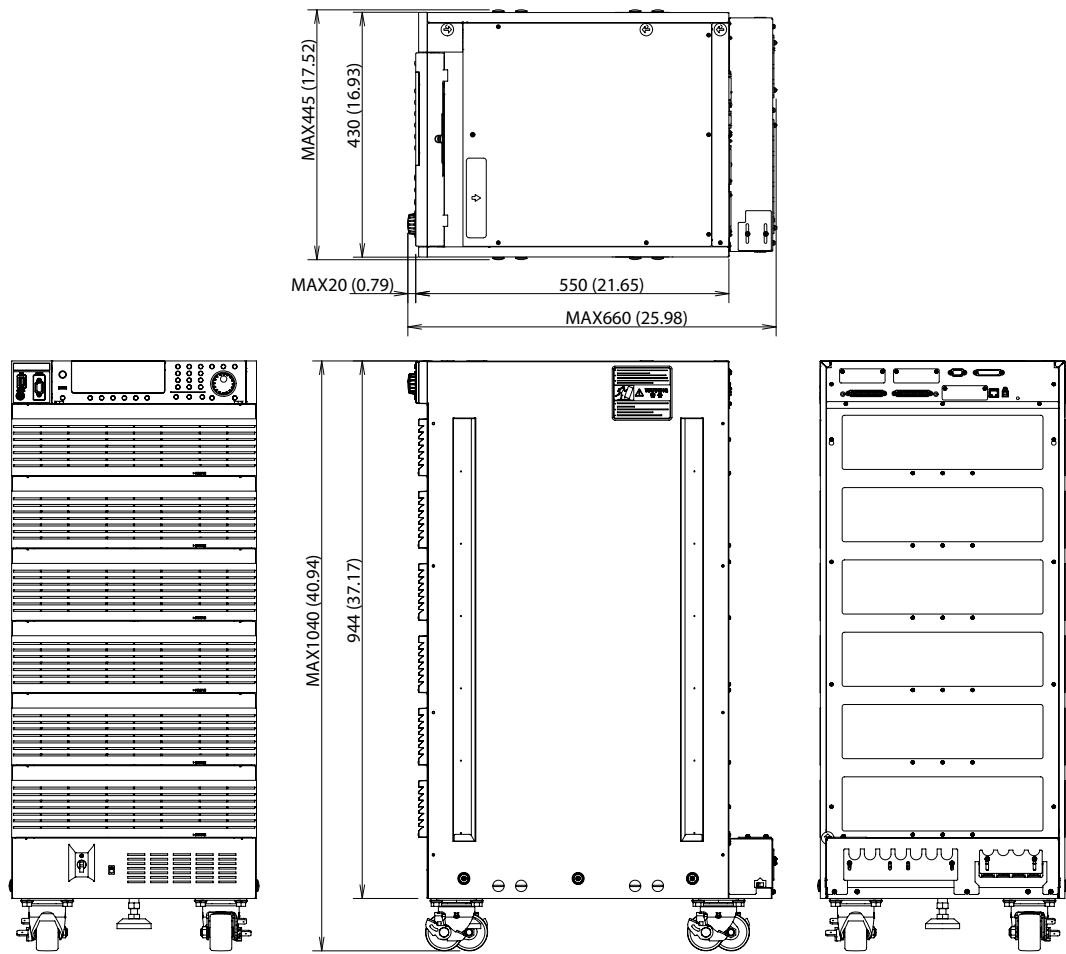

Terminology

■ Rated output capacity

The maximum output power capacity (in VA) that can be supplied continuously. For example, this is 6 kVA on the PCR6000WE2.

■ Rated output current

The maximum rms current (in A) that can be output continuously.

The rated output current varies depending on the output conditions (the number of power modules in use, output voltage range, output voltage, output frequency).

The output current requires derating (reduction) according to the output conditions (output voltage, output frequency).

■ Rated maximum output current

This is the maximum rms output current (in A) that can be supplied continuously in the following ranges. For example, on the PCR6000WE2, this is 60 A for single-phase output when the output range is L.

$$\text{Rated maximum output current} = \frac{\text{Rated output capacity [VA]}}{\text{Voltage at 100 \% of the output voltage ratio [V]}^*}$$

* See "Output voltage ratio" (p.222). Output L range is 100 V, and output H range 200 V.

■ Inrush current capacity

The current that can be supplied to a load (e.g., motor) that you want to supply power exceeding the rating for a short period and the duration.

■ Maximum peak current

The peak output current (in A_{peak}) that can be supplied continuously to produce a crest factor of 4.

$$\text{Maximum peak current} = \text{rated maximum output current (rms)} \times 4.$$

$$\text{Crest factor} = \frac{\text{Peak value}}{\text{Rms value}} \leq 4 \text{ only}$$

■ Output current ratio

The output current as a percentage where the rated maximum output current is 100 %.

■ Output voltage ratio

The output voltage as a percentage where 100 V for the output L range or 200 V for the output H range is 100 %.

■ Output voltage waveform distortion ratio

The total harmonic distortion (in %) of the output voltage waveform when the output voltage is between 80 V and 155 V (for output L range) or between 160 V and 310 V (for output H range) and the load power factor is 1.

■ Output voltage transient response

The time (in μs) from when the output voltage variation exceeds 10 % of the total variation to when it returns within 10 % when the output current ratio is varied from 0 % to 100 % with the output voltage at 100 V (output L range) or 200 V (output H range) and the load power factor at 1.

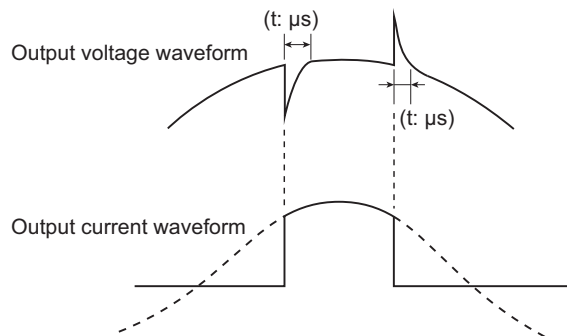

■ Capacitor-input rectifier load (circuit)

A load whose rectifier circuit part is constructed as shown below. The rectifier circuit is used to convert the input AC voltage into the DC voltage that the device needs to operate.

The peak input current is normally approximately two to four times the rms value. The conduction angle (the period that the current is flowing for) centered on the peak output voltage (phase angle of 90° or 270°) is approximately 20° to 90° .

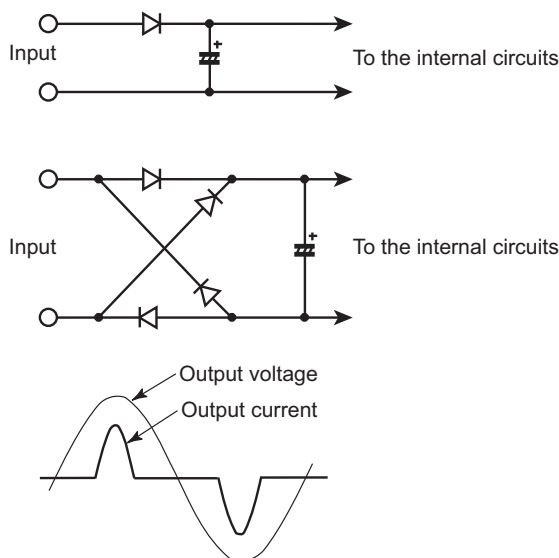

■ Derating

"Derating" means "reducing." In general, this refers to using a device at reduced maximum rated values (such as the voltage and the current) depending on the ambient conditions (such as the temperature and load).

■ **Voltage dip**

This refers to situations in which the voltage in a commercial power line drops momentarily due to the effects of lightning and other similar phenomena.

Generally, these voltage drops last for several tens of milliseconds to several hundreds of milliseconds, and the voltage drops by 20 % to 80 %.

Power Regeneration Function (PCR-WE2R only)

The PCR-WE2R has a power function that regenerates power, which could not be consumed with the normal inverter system, to the AC LINE. If you use the PCR-WE2R as a power system simulator, you do not need a regenerative resistive load. This also helps to suppress the level of exhaust heat and saves energy. It can be used also in DC mode.

The PCR-WE2R is designed for local regeneration; it cannot be used to generate reverse power flow from the site back to the power company's system.

NOTE The PCR-WE2R is designed for local regeneration applications. It cannot be used if the local power consumption is less than the regenerated power.

The load connection (p.27) is the same for regeneration.

If the output becomes unstable or oscillates depending on the load circuits (especially in the case of capacitive loads) and the wiring conditions, change the response.

The limit and protection functions (p.66) also work the same for regeneration.

NOTE Operation of the current limit function during regeneration
Even when DISABLE (do not turn off the output) is selected, if a current exceeding the current limit flows, the output is turned off.

A protection function based on an internal setting (fixed) is activated to protect the regeneration function, and an alarm (ALM-11: P.U INPUT VOLT or ALM-12: P.U INPUT ERR) is generated.

System overvoltage and undervoltage

System frequency increase and decrease

Standalone operation inhibit

NOTE The protection function for the regeneration function does not comply with the Grid-interconnection Code (Japanese regulation).

Output and Load

Rated output current for AC output

The rated current is automatically derated (reduced) depending on the output conditions (output voltage and frequency).

Output voltage ratio:

A percentage where 100 % represents an output voltage of 100 V (L range) or 200 V (H range).

Output current ratio:

A percentage where 100 % represents the maximum rated output current.

Rated maximum output current:

Single-phase output

	PCR 1000WE	PCR 2000WE	PCR 3000WE2	PCR 6000WE2	PCR 12000WE2	PCR 18000WE2	PCR 24000WE2	PCR 30000WE2	PCR 36000WE2
L range	10 A	20 A	30 A	60 A	120 A	180 A	240 A	300 A	360 A
H range	5 A	10 A	15 A	30 A	60 A	90 A	120 A	150 A	180A

1P3W output, 3P output

	PCR 3000WE2	PCR 6000WE2	PCR 12000WE2	PCR 18000WE2	PCR 24000WE2	PCR 30000WE2	PCR 36000WE2
L range	10 A	20 A	40 A	60 A	80 A	100 A	120 A
H range	5 A	10 A	20 A	30 A	40 A	50 A	60A

- Figure 3 Output voltage ratio vs. output current ratio (AC output)

Output current ratio [%] when the output voltage setting (ACvolt) is between 0 V and 100 V (L range) or between 0 V and 200 V (H range): 100

Output current ratio [%] when the output voltage setting (ACvolt) is 100 V or higher (L range) or 200 V or higher (H range): $100/\text{output voltage ratio} \times 100$

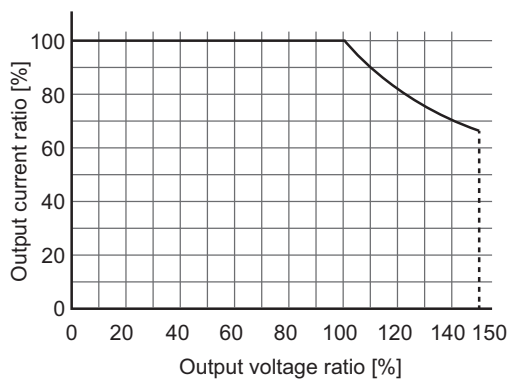

- Figure 4 Output frequency vs. output current ratio

Output current ratio [%] when the output frequency (Freq) is less than 40 Hz: $70 + (\text{output frequency} - 1) \times 30/39$

Output current ratio [%] when the output frequency (Freq) is greater than or equal to 40 Hz: 100

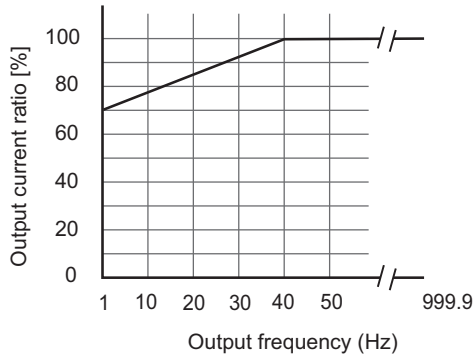

How to determine the rated current

The rated output current for AC output depends on the output conditions (output voltage, output frequency). The rated output current under given output conditions is the value obtained by converting the smaller of the two values: the output current ratio derived from fig. 3 (output voltage) or the output current ratio derived from fig. 4 (output frequency).

On the control panel, the full scale of the load level meter is 1.1 times the rated current or the current limit, whichever is less.

AC output voltage frequency response

The following figure shows an example of the AC output voltage frequency response. The frequency response is affected by the load conditions and selected response.

- Frequency response for rated output voltage, current

With a rated current load connected using the rated voltage output with high-speed response (FAST) mode selected

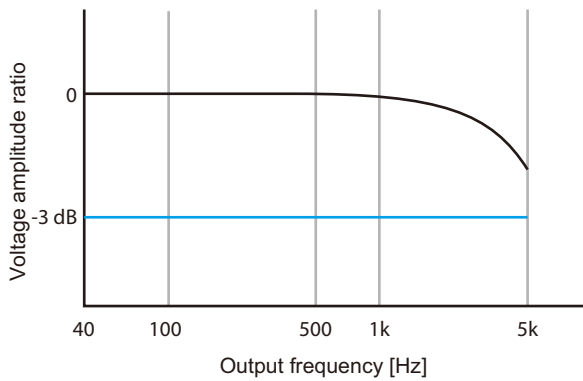

Frequency response for analog input

The following figure shows an example of the AC output voltage frequency response when an analog signal is applied. The frequency response is affected by the load conditions.

- Frequency response for rated output voltage, current

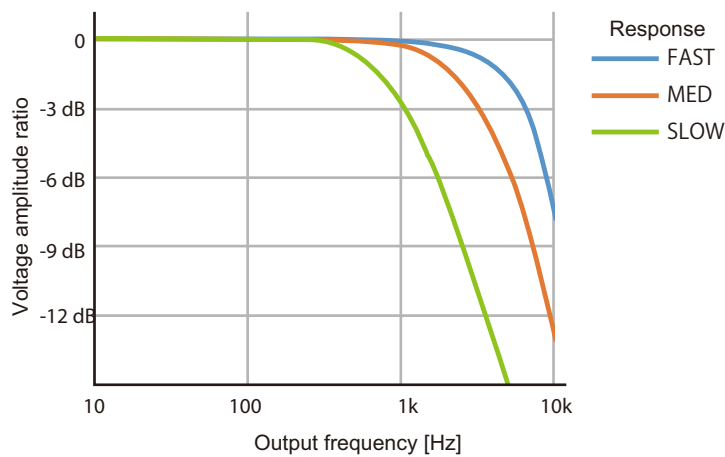

Options

This is a list of the PCR-WE/PCR-WE2 options.

Input power cords

These are available power cords for this product. The switchboard ends of the power cords have not been prepared for connection.

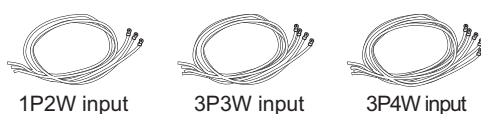

		Model	cable	Length	Nominal Cross-Sectional Area	Input terminal
PCR1000WE PCR2000WE	1P2W input	AC5.5-1P3M-M6C-3S	Single core, 3 pcs.	3 m	5.5 mm ²	M6
PCR3000WE2	1P2W input	AC14-1P3M-M6C-3S	Single core, 3 pcs.	3 m	14 mm ²	M6
PCR6000WE2	3P3W input	AC5.5-1P3M-M5C-4S	Single core, 4 pcs.	3 m	5.5 mm ²	M5
	3P4W input	AC5.5-1P3M-M5C-5S	Single core, 5 pcs.	3 m	5.5 mm ²	M5
PCR12000WE2	3P3W input	AC14-1P3M-M5C-4S	Single core, 4 pcs.	3 m	14 mm ²	M5
	3P4W input	AC5.5-1P3M-M5C-5S	Single core, 5 pcs.	3 m	5.5 mm ²	M5
PCR18000WE2	3P3W input	AC22-1P3M-M8C-4S	Single core, 4 pcs.	3 m	22 mm ²	M8
	3P4W input	AC8-1P3M-M5C-5S	Single core, 5 pcs.	3 m	8 mm ²	M5
PCR24000WE2	3P3W input	AC38-1P3M-M8C-4S	Single core, 4 pcs.	3 m	38 mm ²	M8
	3P4W input	AC14-1P3M-M5C-5S	Single core, 5 pcs.	3 m	14 mm ²	M5
PCR30000WE2 PCR36000WE2	3P3W input	AC60-1P3M-M8C-4S	Single core, 4 pcs.	3 m	60 mm ²	M8
	3P4W input	AC22-1P3M-M5C-5S	Single core, 5 pcs.	3 m	22 mm ²	M5

External Control Connector

These are connectors for controlling the product using digital signals (OP01-PCR-WE) and analog signals (OP02-PCR-WE).

The OP01-PCR-WE is the same as the included connector except that pin 4 (CTRL.4 (shutdown signal)) is open.

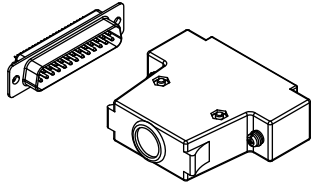

OP01-PCR-WE

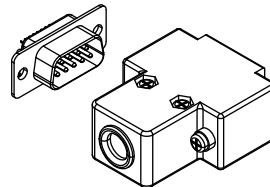

OP02-PCR-WE

Rack Mount Brackets

By using the rack mount brackets, you can mount the PCR1000WE, PCR2000WE, PCR3000WE2, PCR6000WE2, and PCR12000WE2 to the KRO1600, KRO1250, KRO900, and KRC Series standard racks made by Kikusui.

The following table lists the brackets that are used to attach the PCR-WE Series to EIA inch racks or JIS millimeter racks. For details on how to mount the product to the rack, see the each operation manual.

	Type of rack to mount to	Bracket model
PCR1000WE	EIA inch rack	KRB3-TOS
PCR2000WE PCR3000WE2	JIS millimeter rack	KRB150-TOS
PCR6000WE2	EIA inch rack	KRB6
	JIS millimeter rack	KRB300
PCR12000WE2	EIA inch rack	KRB9
	JIS millimeter rack	KRB400-PCR-LE

Detach the casters before you mount the PCR-WE Series to a rack mount frame.

Detaching the feet and casters

We recommend that you keep all pieces that you have removed from the PCR-WE Series. You will need these pieces if you re-move the PCR-WE Series from the rack.

■ Detaching the feet and screws (PCR1000WE/ PCR2000WE/ PCR3000WE2)

Remove the screw that hold each foot in place to detach the four feet.
Also remove the four screws on the side panels.

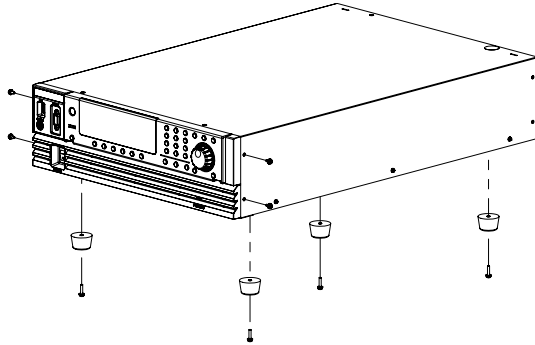

■ Detaching the casters (PCR6000WE2/ PCR12000WE2)

Remove the three screws that hold each caster in place to de-tach the four casters.

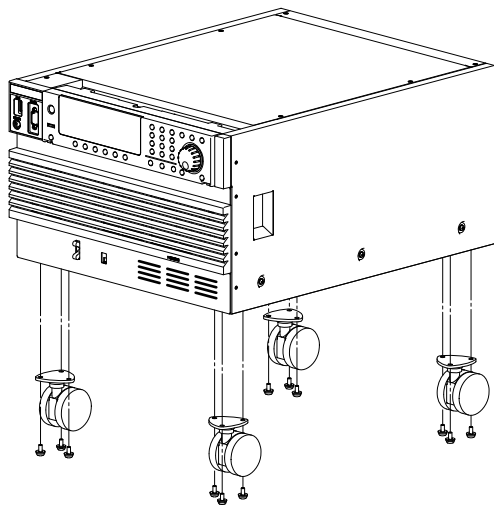

Outline diagram and dimensions

Unit: mm (inch)

- PCR1000WE/ PCR2000WE/ PCR3000WE2
When mounting on an inch rack (bracket model KRB3-TOS)

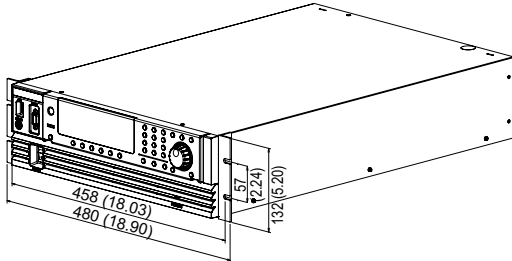

When mounting on a millimeter rack (bracket model KRB150-TOS)

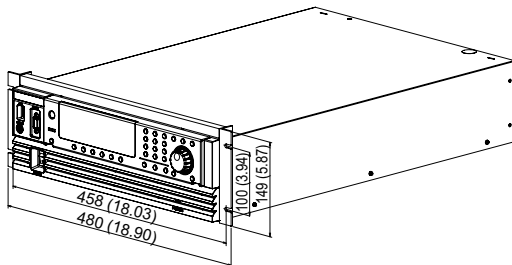

- PCR6000WE2
When mounting on an inch rack (bracket model KRB6)

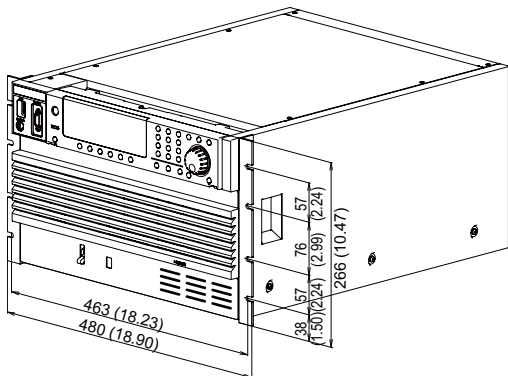

When mounting on a millimeter rack (bracket model KRB300)

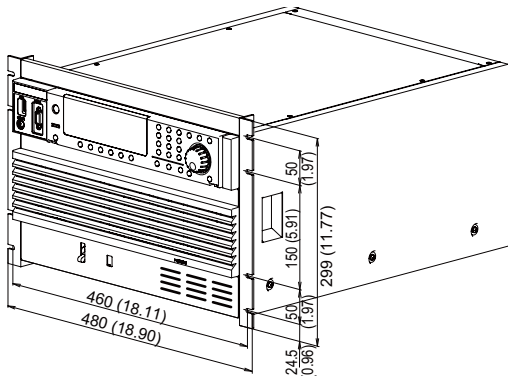

- PCR1200WE2

When mounting on an inch rack (bracket model KRB9)

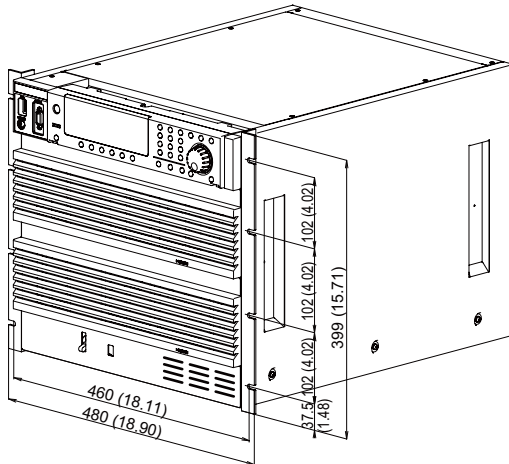

When mounting on a millimeter rack (bracket model KRB400-PCR-LE)

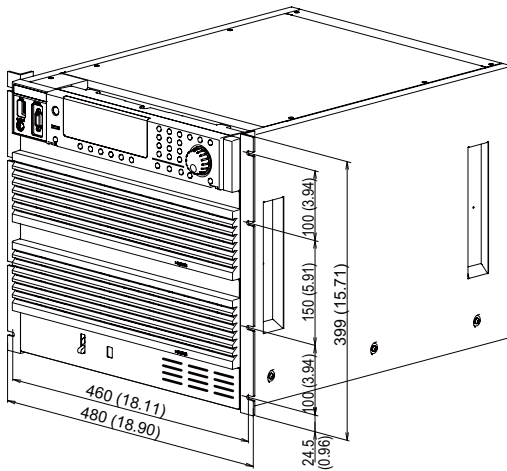

GPIB interface board (IB07-PCR-WE)

By using the GPIB interface board, you can control this product through the GPIB.

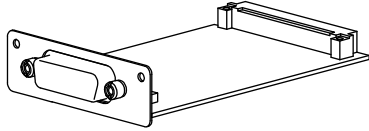

Insert the interface board in the slot on the rear panel.

■ Installation

Do not handle the interface board in environments where static electricity is easily produced.

- 1** Turn off the **POWER** switch.
- 2** Touch a grounded metal object (for example, the metal parts of the rear panel) to discharge any static electricity from your body.
- 3** For the PCR1000WE/ PCR2000WE/ PCR3000WE2, remove the screws that are holding the slot cover in place on the rear panel, and remove the cover from the panel.
For the PCR6000WE2/PCR12000WE2/PCR18000WE2/PCR24000WE2/ PCR30000WE2/PCR36000WE2, remove the screws that are holding the SLOT 3 cover in place on the rear panel, and remove the cover from the panel.
- 4** Hold the panel parts of the board so that the printed circuit board side is facing up.
- 5** Insert the board into the slot so that the printed circuit board's connector is inserted into the connector at the back of the slot.
- 6** Insert the board all the way into the slot.
- 7** Use the screws that you removed in step 3 to fix the board in place in the panel.
This completes the installation.

Base hold angles (OP03-KRC)

These are used when you want to fix the PCR3000WE2/PCR3600WE2 or the rack to the floor. For details, see the OP03-KRC Instruction Manual.

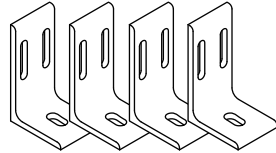

When you are using these with the PCR3000WE2/PCR3600WE2, you can use a coin or similar object to detach and attach the caps that are included with the product. Nuts that are included with the OP03-KRC will not be used.

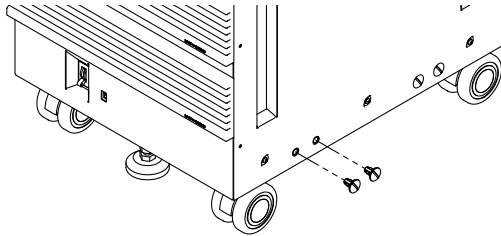

The dimensions of the product when the base hold angles are attached to it are shown in the following figure.

Unit: mm (inches)

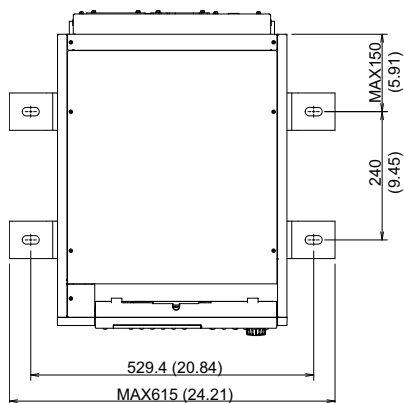

Parallel operation cables (PC01-PCR-WE, LC01-PCR-LE)

The PC01-PCR-WE is a cable (100 cm) for parallel operation. The LC01-PCR-LE is a power synchronize cable (100 cm) for synchronizing power supplies.

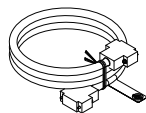

PC01-PCR-WE

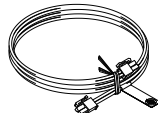

LC01-PCR-LE

Troubleshooting

This section introduces troubleshooting measures. Typical symptoms are listed. Check whether any of the items listed below apply to your case. In some cases, the problem can be solved quite easily.

If none of the items apply to your case, we recommend that you initialize the product to its factory default settings (p. 190). If following the remedy does not solve your problem, contact your Kikusui agent or distributor.

■ The control panel display does not light when the POWER switch is turned on.

Check	Possible cause	Remedy
The rated voltage being applied to the INPUT terminal block.	<ul style="list-style-type: none"> The input power cable is not connected correctly. The input power cable is broken. 	Check whether the input power cable is damaged, and check whether the wires are securely connected to the terminals.
The input voltage is outside the rated range.	There is an input voltage error.	Check the input voltage.

■ The control panel is not responding. Some operations cannot be performed.

Check	Possible cause	Remedy
Key lock mode is enabled.	The key lock is enabled.	Release the key lock.
RMT is displayed.	The product is being controlled remotely.	Press LOCAL (SHIFT+2) to switch the product to local mode (panel operation).
ALARM is displayed.	There is an internal or external error.	Check the alarm type.
There is a device nearby that is generating a lot of noise.	The product is malfunctioning because of noise.	Remove the product from the source of the noise.
The voltage and frequency limits are set to values outside the settable ranges.	The limit settings are inappropriate.	Set the limits to correct values.

■ The control panel display is abnormal.

Check	Possible cause	Remedy
There is a device nearby that is generating a lot of noise.	The product is malfunctioning because of noise.	Remove the product from the source of the noise.

■ The output voltage is not generated or is different from the specified voltage.

Check	Possible cause	Remedy
The output method (single-phase output single-phase three-wire output or three-phase output) is set correctly.	The cables are connected to the incorrect terminal block.	Connect the output cables to the correct terminal block.
Cables are correctly connected to the output terminal block.	The output method is not set correctly.	Specify the correct output method.

■ The output voltage is being generated, but the measured voltage is 0 V.

Check	Possible cause	Remedy
The voltage measurement display is set to DC.	Only AC voltage is being generated.	Press V-MEAS (SHIFT+V) to set the voltage measurement display to a setting other than DC.

■ The output voltage waveform is distorted.

Check	Possible cause	Remedy
OVER LOAD is displayed.	The current limit is activated.	The product may be overloaded. Inspect the load.

■ P.U OHP is displayed.

Check	Possible cause	Remedy
Vent or inlet holes are blocked.	<ul style="list-style-type: none"> The overheat protection (ALM-02) is activated. The dust filter is clogged. 	<p>Move the product so that there is at least 50 cm of space between the vents and the surrounding walls.</p> <p>Do not place objects within 50 cm of the vents. Clean the dust filter to remove any clogs.</p>
The ambient temperature is above 50°C.	The overheat protection (ALM-02) is activated.	Use the product in an environment in which the ambient temperature is 50 °C or less. Keep loads that generate a high temperature away from the product.

■ An output current cannot be generated ("ALM-06: OVER LOAD" is displayed).

Check	Possible cause	Remedy
The output voltage range is not correct.	The range is set to the H range.	Set the output voltage range to L.
The current limit value is not correct.	The current limit settings are inappropriate.	Set the current limits to correct values.
The OUTPUT terminal block connection is not correct.	The output method and the OUTPUT terminal block connection are not matched.	Connect the OUTPUT terminal block again according to the output method (p.47).

■ Power line abnormality simulations or sequences cannot be executed.

Check	Possible cause	Remedy
A simulation or sequence is not executed even when you press RUN.	Voltage range, limit, compensation, and other settings are set to conditions in which simulations and sequences cannot be executed.	<p>Conditions for executing power line abnormality simulations (p.100)</p> <p>Conditions for executing sequences (p.129)</p>

■ Phase settings are not correct (U PH OFS and UNBAL icons).

Check	Possible cause	Remedy
The U PH OFS icon is displayed.	The U phase is offset.	The U phase is left offset in a sequence. Press SEQ (SHIFT+SIM) > 1/2 > U PHASE to clear the offset.
The UNBAL icon is displayed.	Unbalanced phase difference or phase voltage is being used.	Change to a correct value (p.42).

■ The output operation is unstable.

Check	Possible cause	Remedy
The load cables are not run alongside each other.	The wiring conductance is large.	Connect by running them alongside each other).

■ The output turns off earlier than the trip time setting.

Check	Possible cause
The full scale bar of the load level meter continues to be lit.	Increase in the internal temperature of the PCR-WE If an overload occurs repeatedly, the time until the output is turned off may be shortened.

■ The output cannot be turned on.

Check	Possible cause
"Busy" is shown on the display.	Output cannot be turned on in the busy status.
"TRBL-19" is shown on the display.	The shutdown function is activated. Check whether the included external control connector is connected to the DIGITAL I/O connector. Turn the power off and then back on.

■ The firmware cannot be updated.

Check	Remedy
The error message "Update file is not found" is shown on the display.	Remove the USB memory device, and on your PC, check that the update file is in the root directory.
The error message "USB memory is not mounted" is shown on the display.	Restart the PCR-WE/PCR-WE2. Insert the USB memory device, and check whether the message "USB Memory found" appears. If it does not, use a different USB memory device.
The error message "Updater is not found" is shown on the display.	Updating failed. Note the error code, and turn the PCR-WE/PCR-WE2 POWER switch off. You will not be able to continue with the updating. You will not be able to revert to the previous version either. Contact your Kikusui agent or dealer.
The error message "Update file failure" is shown on the display.	The version of the firmware in the USB memory device is older than the version of the firmware that is currently running.

Alarms and Trouble

Overview

When a protection function is activated, an alarm or a trouble indication is generated, and the output is turned off. Press ALM CHK (F5) to view the details.

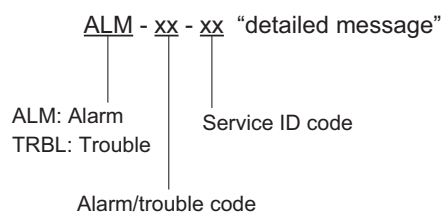

- Alarms

An alarm occurs to indicate that a protection function has been activated. Press ALM CLR (SHIFT+CLR) to clear the alarm, and then fix the problem that caused the alarm.

- Trouble

A trouble occurs when the product is used improperly or when there is a risk of damage to the product or EUT. Turn the POWER switch off, wait at least 5 seconds, and then turn it back on. If the same trouble indication occurs again, contact your Kikusui agent or distributor to request repairs.

If multiple alarms occur, only the first alarm will be displayed. To display the other alarms that are occurring, press ALM CHK (F5), and then turn the rotary knob.

The detailed message may reveal where the alarm or trouble occurred.

Example: When ALM-06 OVERLOAD occurs, pressing ALM CHK (F5) displays "ALM-06-04 OVERLOAD V." The detailed message shows that the overload protection was activated on the V phase.

When contacting your Kikusui agent or distributor to request repairs, tell the agent or distributor the error number or trouble number that occurred.

Remedy

Alarm numbers and their remedies

Alarm number	Symptom and remedy
ALM-00 OVP	The output overvoltage protection has been activated. This occurs when the measured rms voltage exceeds the OVP setting for approximately 1 second.
ALM-01 P.U ERR	The internal Vcc overvoltage protection has been activated. A voltage greater than or equal to the set voltage has been regenerated from the output side of the PCR-WE, or the output wires may have shorted during single-phase three-wire output or three-phase output. Alternatively, the PCR-WE may be malfunctioning. If the alarm occurs even after you fix the problem that caused the alarm, stop using the PCR-WE immediately, and contact your Kikusui agent or distributor to request repairs.
ALM-02 P.U OHP	The overheat protection has been activated. The internal temperature is abnormally high. Leave the product on, and wait for approximately 10 minutes. If the alarm is still occurring after 10 minutes, check that the power cord is connected correctly. If the alarm has stopped occurring after 10 minutes, the PCR-WE may have been installed incorrectly, or the dust filter may be clogged. If there are no problems with the installation or the dust filter, and contact your Kikusui agent or distributor to request repairs.
ALM-02 OPP	ALM-02-13 UNBALANCE POWER L1 The power limit protection has been activated. The output power of the internal inverter L1 is biased.
	ALM-02-14 UNBALANCE POWER L2 The power limit protection has been activated. The output power of the internal inverter L2 is biased.
	ALM-02-15 UNBALANCE POWER L3 The power limit protection has been activated. The output power of the internal inverter L3 is biased.
ALM-03 OCP	ALM-03-03 UNBALANCE CURR L1 The current limit protection has been activated. The output current of the internal inverter L1 is biased.
	ALM-03-04 UNBALANCE CURR L2 The current limit protection has been activated. The output current of the internal inverter L2 is biased.
	ALM-03-05 UNBALANCE CURR L3 The current limit protection has been activated. The output current of the internal inverter L3 is biased.
ALM-04 P.U FAN ERR	Fan error
ALM-06 OVERLOAD	The overload protection function has been activated. The output current has exceeded the rated value or the current limit. Fix the problem that caused the overload to occur, and then press OUTPUT again. The overload should be cleared, and the output should turn on.
ALM-07 UVP	The output undervoltage protection has been activated. This occurs when the measured rms voltage is lower than the UVP setting for approximately 1 second.

Alarm number		Symptom and remedy
ALM-08 P.U FAULT	ALM-08-00 P.U FAULT(ALL)	Power module paused. All the power modules are paused.
	ALM-08-01 P.U FAIL	Power module malfunction. At least one of the power modules has malfunctioned. Contact your Kikusui agent or distributor to request repairs. If this alarm occurs for some of the power modules, you can clear the alarm and use the product temporarily.
ALM-10 WDOG TIMEOUT		The communication monitoring (watchdog) function has activated. This is activated when an SCPI command is not received for the specified period.
ALM-11 P.U INPUT VOLT		An input open phase was detected. There may be a problem with the input wiring or an interruption may have occurred. Turn the power off, check the input wiring, and then turn the power back on.
ALM-12 P.U INPUT ERR		An input overvoltage or frequency error was detected. There may be a problem with the input wiring. Turn the power off, check the input wiring, and then turn the power back on.
ALM-15 CAL.DATA ERR		Calibration value error. Contact your Kikusui agent or distributor to request repairs.
ALM-19 EXT ALARM		An alarm occurred on the external signal, and the output was turned off.
ALM-29 AC INPUT LOW		The input voltage dropped lower than the rated value and then recovered. There may be a problem with the input wiring or an interruption may have occurred. Turn the power off, check the input wiring, and then turn the power back on.
Other alarms or trouble indicators		Contact your Kikusui agent or distributor to request repairs.

Trouble numbers and their remedies

trouble code		Symptom and remedy
TRBL-01	P.U ERR	Power module error. Stop using the product, and contact your Kikusui agent or distributor to request repairs.
TRBL-03	HW FAILURE	The internal circuit protection has been activated. Contact your Kikusui agent or distributor to request repairs.
TRBL-06	P.U UNDETECTED	Not all of the power modules can be detected. Contact your Kikusui agent or distributor to request repairs.
TRBL-11	P.U SWITCHING ERR	Internal switch status error. Contact your Kikusui agent or distributor to request repairs.
TRBL-14	HW FAILURE	Internal communication error, ROM value error, etc. Contact your Kikusui agent or distributor to request repairs.
TRBL-19	EXT. SHUTDOWN	The output was turned off with a shutdown signal received through the external contact. The shutdown function is activated. Check whether the included external control connector is connected to the DIGITAL I/O connector. Turn the power off and then back on.
TRBL-20	MEAS FAIL	Measurement error. Contact your Kikusui agent or distributor to request repairs.
TRBL-22	VERSION ERR	In parallel operation, the combination of the firmware versions of the master unit and slave units are not correct. Update the firmware, and align the versions.
TRBL-23	OPTION ERR	Option board installation error. Install the board correctly. If the board is installed correctly, contact your Kikusui agent or distributor to request repairs.
TRBL-29	AC INPUT LOW	The input voltage has become lower than the rated value. There is a problem with the input wiring. Turn the power off, check the input wiring, and then turn the power back on.
TRBL-31	P.D SYSTEM ERR	Parallel operation system error. The parallel operation configuration is in error. If the addresses and the number of slave units are set correctly, contact your Kikusui agent or distributor to request repairs.
TRBL-35	FW STARTUP FAIL	Startup failure. Contact your Kikusui agent or distributor to request repairs.
Other alarms or trouble indicators		Contact your Kikusui agent or distributor to request repairs.

Error Messages

If you attempt to set a value that is not possible, the PCR-WE will generate a beep and an error message.

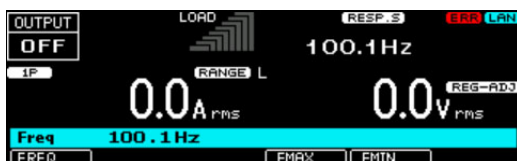

For details on USB memory error messages, see “USB error messages” (p.79).

■ Error messages

Error message	Symptom
+102, "Operation denied (OUTPUT ON)"	Denied because the output is on.
+103 "Operation denied (PROTECTION)"	Denied because a protection function is activated.
+104 "Operation denied (OUTPUT COUPLING)"	Denied because the command is in conflict with the output mode.
+105 "Operation denied (OUTPUT OFF)"	Denied because the output is off.
+106 "Operation denied (TRIP DISABLE)"	Denied because the action to perform when the current limit is exceeded is set to "not to turn the output off (DISABLE)."
+107 "Operation denied (RISE TIME/SIM/SEQ)"	Denied because soft start, power line abnormality simulation, or sequence is in progress.
+108 "Operation denied (WIRING METHOD)"	Denied because the wiring method (single-phase, three-wire or three-phase) is invalid.
+109 "Operation denied (EXT.OUTPUT OFF)"	Denied because the output has been turned off through external control.
+110 "Operation denied (EXT.SEQ.STOP)"	Denied because a sequence is being executed or stopped through external control.
+111 "Operation denied (V-PROG)"	Denied because the AC voltage output is being controlled with an external signal.
+112 "Operation denied (SOURCE)"	Denied because the command is in conflict with the signal source setting.
+198 "Operation denied (ENTRY)"	Denied because the PCR-WE is waiting for an ENT key input.
+199 "Operation denied (BUSY)"	Denied because the PCR-WE is busy.
+201 "Operation denied (FREQ)"	The sequence cannot be executed because there is a step whose frequency is outside its limits.
+202 "Operation denied (VOLT)"	The power line abnormality simulation or sequence cannot be executed because there is a step whose voltage is outside the voltage range or limits.
+203 "Operation denied (PHASE CHANGE)"	The sequence cannot be executed because there is a step whose trigger wait setting and sudden phase change setting are both turned on.
+301 "Setting Conflict (COMPENSATION)"	Cannot be set because the command is in conflict with the compensation setting.
+302 "Setting Conflict (CV RESPONSE)"	Cannot be set because the command is in conflict with the response setting.
+303 "Setting Conflict (RISE TIME)"	Cannot be set because the soft start output is in progress or the command is in conflict with the soft start setting.

Error message	Symptom
+304 "Setting Conflict (SYNCRO)"	Cannot be set because the sync function is on.
+305 "Setting Conflict (TRIP)"	Cannot be set because the command is in conflict with the action that is performed when any of the current limits is exceeded.
+306 "Setting Conflict (UNBALANCE PHASE)"	Cannot be set because the phase difference is unbalanced.
+308 "Setting Conflict (OUTPUT IMPEDANCE)"	Cannot be set because an output impedance is set.
+309 "Setting Conflict (WAVE BANK)"	Cannot be set because a waveform other than waveform bank No. 0 is in use.



Index

A

AC coupling	60
AC.C	60
accessories	3
Alarms	239
clear	72
Amplifying the input waveform	155
ANALOG IN connector pin arrangement.....	153

B

Backup battery	199
Base hold angles.....	235
Busy	41

C

calibration	199
compensation function	86
component names.....	10
Contents	7
Control panel.....	11, 37
Control Using Analog Signals	152
Controlling the PCR-WE through external contacts ..	166
current limit.....	68

D

date and time	77
derating	218
display	12
current, power, power factor.....	64
peak current hold.....	65
peak voltage hold	62
single-phase three-wire output and three-phase out- put.....	42
voltage	61

E

Ending phase angle	115
ENT	40
Error Messages.....	243
ESC key	40
EXT SYNC	85
External Control	
ANALOG IN connector pin arrangement	153
Control Using Analog Signals.....	152
Amplifying the input waveform	155
Varying the output voltage or frequency using DC signals	158
Control Using Digital Signals	162
Controlling the PCR-WE through external contacts 166	
DIGITAL I/O connector pin arrangement and map- ping.....	163
Monitoring the operation status.....	171
Selectable I/O	174
External control connector	151
external control.....	151

F

Factory Default Settings	190
firmware version	46
flat curve waveform	102
frequency.....	55
front panel.....	10

G

GPIB	189
GPIB interface board	234

H

hard sensing	86
high stability.....	108
high-speed response	108
home position	40

I

icons	12
Input power cords	229
input sync signal	84
interface settings	188
IPK.LIM.....	69

K

key lock.....	46
keyboard.....	44
KEYLOCK.....	46

L

LAN.....	188
limit function.....	66
line voltage	43
load connection	27
load level meter	63
local mode, switching to	41

M

Main Unit Specifications	200
measurement	
current, power, power factor	64
averaging.....	64
peak current hold	65
peak voltage hold.....	62
voltage	61
averaging.....	61
Monitoring the operation status	171
moving the product	4

N

normal speed.....	108
notations used in this document	3
numeric keypad	44

O

OFF PHASE	59
OHP	72
ON PHASE	59
Options	229
Base hold angles	235
GPIB interface board	234
Input power cords	229
Parallel operation cables	235
OUT Z	105
output and load	226
output impedance	105
output method	47
output off	
impedance	57
voltage surge suppression	58
output on/off	56
output on/off phase control	59
output voltage	
range	48
output voltage, setting	49
output voltage, setup procedure	51
OUTPUT*	58
OVERLOAD	70
overview	5
OVP	73

P

panel	
control	11
front	10
rear	14
panel operation	37
parallel operation	177
Parallel operation cables	235
peak current limit	68
phase difference	53
phase voltage	43
phase wait time	116
power cord	16
connecting	19
power line abnormality simulation	
status signal output	100
power module	5
power module management function	111
power on/off	24
POWER switch	25
condition when tuned on	26
Preset memory	75
protection function	66

R

ramp	114
Rated output current characteristics	218
rear panel	14
REG-ADJ	95
regulation adjustment	87
Reset Settings	190
RESP	108
Response	108
Rotary knob	44

S

S	104
SCPI error	189
screen brightness	45
screen, parts of	39
Selectable I/O	174
SENS	93
Sequence	112
Jump function	123
Status signal output	121
Trigger input	121
Trigger signal output	121
tutorial	130
creation basics	132
Line voltage dip	149
Phase setting for multi-phase output	143
Phase sweep	147
Single-phase three-wire output and three-phase	
output basics	142
Suddenly changing the phase	140
Switching steps at specific phase angles	137
Voltage sweep and frequency sweep	135
U-phase offset	126
serial number	15
Setting the Watchdog Protection	187
settings, canceling	40
setup memory	78
sleep function	109
soft sensing	86
Soft start and soft stop	106
specifications	200
Starting phase angle	115
Step's signal change	114
Sudden phase change	116
SYNC	85
synchronization	84
synchronization delay phase angle	84
system settings	187

T

TRIP DIS.	70
Trouble	239
troubleshooting	236

U

U PH OFS	129
UNBAL	43
unbalanced setting	43
Updating	196
USB memory	
error messages	79
USB memory device	79
UVP	73

V

Varying the output voltage or frequency using DC signals	
158	
voltage compensation function	86
voltage regulation start polarity	98
voltage surge suppression	58

W

waiting for confirmation 40
WDP 187

If you find any misplaced or missing pages in the manuals, they will be replaced. If the manual gets lost or soiled, a new copy can be provided for a fee. In either case, please contact your Kikusui agent or distributor. At that time, inform your agent or distributor of the "Part No." written on the front cover of this manual.

Every effort has been made to ensure the accuracy of this manual. However, if you have any questions or find any errors or omissions, please contact your Kikusui agent or distributor.

After you have finished reading this manual, store it so that you can use it for reference at any time.

KIKUSUI ELECTRONICS CORP.

1-1-3 Higashiyamata, Tsuzuki-ku, Yokohama,
224-0023, Japan

Tel: +81-45-482-6353

Fax: +81-45-482-6261

www.kikusui.co.jp/en

The newest version of the operation manual can be downloaded from Download service of Kikusui website.

