

# PAN SERIES REGULATED DC POWER SUPPLY

Electronic Test  
Instruments &  
Power Supplies

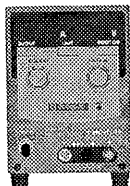

## OPERATION MANUAL



### PAN SERIES MODEL 175W

PAN16-10, PAN35-5,  
PAN55-3, PAN70-2.5,  
PAN110-1.5, PAN160-1

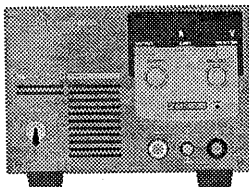

### PAN SERIES MODEL 350W

PAN16-18, PAN35-10,  
PAN55-6, PAN70-5,  
PAN110-3, PAN160-2

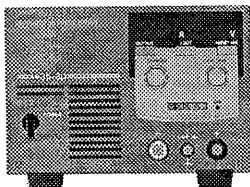

### PAN SERIES MODEL 700W

PAN16-30, PAN35-20,  
PAN55-10, PAN70-8,  
PAN110-5, PAN160-3.5,  
PAN250-2.5

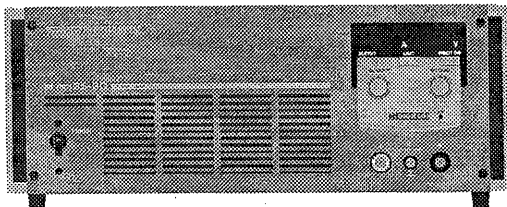

### PAN SERIES MODEL 1000W

PAN16-50, PAN35-30,  
PAN55-20, PAN70-15,  
PAN110-10, PAN160-7,  
PAN250-4.5

## Use of Operation Manual

- Please read through and understand this Operation Manual before operating the product. After reading, always keep the manual nearby so that you may refer to it as needed. When moving the product to another location, be sure to bring the manual as well.
- If you find any incorrectly arranged or missing pages in this manual, they will be replaced. If the manual it gets lost or soiled, a new Operation Manual can be purchased. In either case, please contact your Kikusui agent, and provide the "Kikusui Part No." given on this page.
- This manual has been prepared with the utmost care; however, if you have any questions, or note any errors or omissions, please contact your Kikusui agent.

Reproduction and reprinting of this product as well as this operation manual, whole or partially, without our permission is prohibited. Both unit specifications and manual contents are subject to change without notice.

## ⚠ Safety Precautions

The following safety precautions must be observed to avoid fire hazard, electrical shock, accidents, and other failures. Keep them in mind and make sure that all of them are observed properly. Kikusui assumes no liability against any damages or problems resulting from negligence of the precautions.



### Users

- This product must be used only by qualified personnel who understand the contents of this operation manual.
- If it is handled by disqualified personnel, personal injury may result. Be sure to handle it under supervision of qualified personnel (those who have electrical knowledge.)



### Purposes of use

- If the product is to be used for purposes not described in this manual, contact your Kikusui agent in advance.

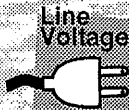

### Input power

- Use the product with the specified input power voltage.
- For applying power, use the AC power cable provided. The shape of the plug differs according to the power voltage and areas. Use the cable which is suitable for the line voltage used.



### Fuse

- With products with a fuse holder on the exterior surface, the fuse can be replaced with a new one. When replacing a fuse, use the one which has appropriate shape, ratings, and specifications.



### **Cover**

- There are parts inside the product which may cause physical hazards. Do not remove the external cover. If the cover must be removed, contact your Kikusui agent in advance.

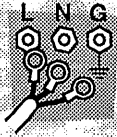

### **Installation**

- When installing products be sure to observe "Precautions for Installation" described in this manual.
- To avoid electrical shock, connect the protective ground terminal to electrical ground (safety ground).
- When applying power to the products from a switchboard, be sure work is performed by a qualified and licensed electrician or is conducted under the direction of such a person.
- Be sure to use the AC power cable provided. Consult your Kikusui agent if other cable than included is to be used for some reason.
- When installing products with casters, be sure to lock the casters.



### **Relocation**

- Turn off the power switch and then disconnect all cables when relocating the product.
- Use two or more persons when relocating the product which weights more than 20 kg. The weight of the products can be found on the rear panel of the product and/or in this operation manual.
- Use extra precautions such as using more people when relocating into or out of present locations including inclines or steps. Also handle carefully when relocating tall products as they can fall over easily.
- Be sure the operation manual be included when the product is relocated.



## Operations

- Check that the AC input voltage setting and the fuse rating are satisfied and that there is no abnormality on the surface of the AC power cable. Be sure to unplug the AC power cable or stop applying power before checking.
- If any abnormality or failure is detected in the products, stop using it immediately. Unplug the AC power cable or disconnect the AC power cable from the switchboard. Be careful not to allow the product to be used before it is completely repaired.
- For output wiring or load cables, use connection cables with larger current capacity.
- Do not disassemble or modify the product. If it must be modified, contact your Kikusui agent.



## Maintenance and checking

- To avoid electrical shock, be absolutely sure to unplug the AC power cable or stop applying power before performing maintenance or checking.
- Do not remove the cover when performing maintenance or checking. If the cover must be removed, contact your Kikusui agent in advance.
- To maintain performance and safe operation of the product, it is recommended that periodic maintenance, checking, cleaning, and calibration be performed.



## Service

- Internal service is to be done by Kikusui service engineers. If the product must be adjusted or repaired, contact your Kikusui agent.

## Safety Symbols

This operation manual and this product use the following safety symbols. Note the meaning of each of the symbols to ensure safe use of the product. (As using symbols depend on the product, all of symbols may not be used.)

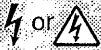

Indicates the presence of 1000V or higher. Never attempt to touch this part when the power switch of the product is turned on. If you need to touch, turn off the power switch and then check the voltage of the terminal.



Indicates the possibility of personal injury or death. Never fail to follow the operating procedure. Do not proceed beyond a WARNING sign until the noted conditions are fully understood and met.



Indicates the existence of damage to the product or connected equipment. Always follow the operating procedure. Do not proceed beyond a CAUTION sign until the indicated conditions are fully understood and met.



Indicates additional information such as operating procedure.



Describes technical terms used in this manual.



Indicates action prohibited.



Indicates general warning, caution, risk of danger. When this mark is indicated on the product, refer the relevant section of the Operation Manual.

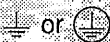

Indicates a grounding (earth) terminal.



Indicates a chassis grounding terminal.

## Arrangement of Operation Manual

This manual is arranged as follows. An outline of each chapter is given below.

### Preface

Describes all the models covered by this manual, as well as outlines the features of each model.

### Chapter 1 Setup

Describes the necessary procedure from unpacking to preparation before use. Since details on installation location and power supply are provided, be sure to read this chapter before using the unit for the first time.

### Chapter 2 Basic Operation

Describes the unit's start-up function, protection circuit, and the basic operations managed from the front panel of the unit.

### Chapter 3 Applied Operation

Explains the remote control of the unit, and use of multiple number of power supply in combination to increase output capacity.

### Chapter 4 Names and Functions of Controls

Provides an outline of the switches and terminals on the panels, including their names and functions.

Read this chapter to learn the meanings of the  caution marks indicated on the panels of the unit.

### Chapter 5 Maintenance

Describes the daily inspection procedures and the calibration conducted when necessary. To remote-control the unit, such calibration is necessary. Follow the calibration procedures detailed in this chapter.

### Chapter 6 Specifications

Describes the electrical, mechanical and general specifications of the unit.

# Contents

⚠ Safety Precautions I

Safety Symbols IV

Arrangement of Operation Manual V

Preface \_\_\_\_\_ P-1

Outline of the manual P-1

Introduction of the products P-2

Option P-3

Chapter 1 Setup \_\_\_\_\_ 1-1

1.1 Checks during unpacking 1-1

1.2 Precautions for moving 1-5

1.3 Precautions for installation 1-6

1.4 Checking the input fuse

(Only models 350W and 700W) 1-8

1.5 Connecting the AC power cable 1-9

1.6 Grounding 1-11

Chapter 2 Basic Operation \_\_\_\_\_ 2-1

2.1 Precautions and preparation for use 2-1

2.2 Turning on the power 2-4

2.3 Basic operation 2-5

2.3.1 OVP trip point presetting 2-5

2.3.2 Using as a constant voltage power source 2-7

2.3.3 Using as a constant current power source 2-8

2.4 Connecting load 2-9

2.5 Mounting the auxiliary output terminal cover 2-12

2.6 Fixing output presetting 2-12



Chapter 3 Applied Operation	_____	3-1
3.1 Remote sensing		3-1
3.2 Analog remote control		3-4
3.2.1 Controlling output voltage with external resistor		3-6
3.2.2 Controlling output voltage with external voltage		3-8
3.2.3 Controlling output current with external resistor		3-10
3.2.4 Controlling output current with external voltage		3-12
3.2.5 Output ON/OFF control		3-14
3.3 Master-slave-control parallel operation		3-16
3.4 Master-slave-control series operation		3-22
Chapter 4 Names and Functions of Controls	_____	4-1
4.1 Front panel		4-1
4.2 Rear panel		4-6
Chapter 5 Maintenance	_____	5-1
5.1 Cleaning		5-1
5.2 Inspection		5-1
5.3 Calibration		5-2
5.3.1 Test equipment required		5-2
5.3.2 Calibration procedure		5-2
Chapter 6 Specifications	_____	6-1
Specifications of PAN Series Model 175W		6-2
Specifications of PAN Series Model 350W		6-7
Specifications of PAN Series Model 700W		6-12
Specifications of PAN Series Model 1000W		6-17

# Preface

## Outline of the manual

The PAN series is classified depending on output capacity. This Operation Manual describes the PAN series, including the specific types named below.

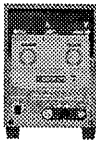

### **PAN SERIES MODEL 175W**

PAN16-10, PAN35-5,  
PAN55-3, PAN70-2.5,  
PAN110-1.5, PAN160-1

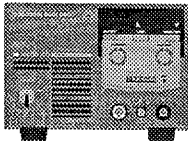

### **PAN SERIES MODEL 350W**

PAN16-18, PAN35-10,  
PAN55-6, PAN70-5,  
PAN110-3, PAN160-2

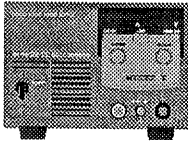

### **PAN SERIES MODEL 700W**

PAN16-30, PAN35-20,  
PAN55-10, PAN70-8,  
PAN110-5, PAN160-3.5,  
PAN250-2.5

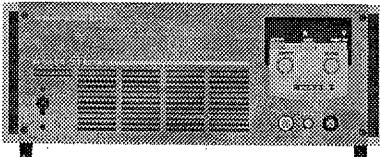

### **PAN SERIES MODEL 1000W**

PAN16-50, PAN35-30,  
PAN55-20, PAN70-15,  
PAN110-10, PAN160-7,  
PAN250-4.5

Fig. P-1 Models and types covered by this manual

The contents of this manual apply to all the models shown in the above-mentioned. However, descriptions of specific types and models are designated as follows.

### Example 1 Descriptions of entire models of 175W and 1000W



The input fuses of the models 175W and 1000W are located inside, and users are not able to check or replace them.

### Example 2 Descriptions of PAN16-18, PAN16-30, and PAN35-20

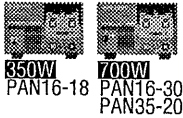

No front auxiliary output terminal cover is available and necessary for the models shown on the left.

## Introduction of the products

The PAN series is an automatic constant voltage/constant current shifting regulated DC power supply equipped with the phase control pre-regulator. A series regulator system is used to assure low-noise and stable output.

The PAN series are featured with the following points.

- The two distinctly visible LED display units on the front panel display output voltage, output current and various preset data.
- The output control potentiometer (for voltage and current presetting) is of a 10-turns wire-wound design, and allows precise setting.
- Electronic switch for low chattering and noise is used to turn on and off the power output.
- Using external voltage or external resistor, output voltage and current can be remote-controlled. With the GPIB interface available with our PIA3200, an automatic testing system can be formed.
- The phase control pre-regulator is furnished with a choke input smoothing circuit, which decreases apparent input power and suppresses harmonic components in the input current. Therefore, potential effects on the power line, such as input voltage distortion, are decreased.
- High-speed transient response of 50  $\mu$  s allows it to follow a sudden load change.

- Carefully selected parts, improved circuit, and forced air cooling heat dissipation combine to produce an excellent low temperature drift of 100 ppm/°C (constant voltage characteristic).
- To protect a load from unexpectedly excessive voltage, the unit includes a built-in OVP (over-voltage protection) circuit capable of handling voltages 10-110% of the rated output voltage.

With the above-mentioned features, PAN series units offers a wide range of applications to laboratory experimental equipment, test equipment for mass-production lines, power supply for aging, etc.

#### NOTE

- Since this unit uses a phase control circuit for the pre-regulator, output is superimposed with pulsive noise. Although the noise level is kept sufficiently low, it may still cause some problem with certain types of applications. Please study this issue carefully before choosing which unit to use.

## Option

The following optional accessories are available for rack mounting.

- Rack mount frame      RMF4M (Metric rack conforming to JIS standards)  
                                    RMF4 (Inch rack conforming to EIA standards)
- Blank panel              BP2, BP4
- Bracket                    B22, B42, BH4M, BH4

#### CAUTION

- The unit is furnished with air intake ports for forced air cooling. For rack mounts, therefore, we request that you mount a blank panel of at least one-unit width on the rack.

For details on optional accessories, contact your Kikusui agent.

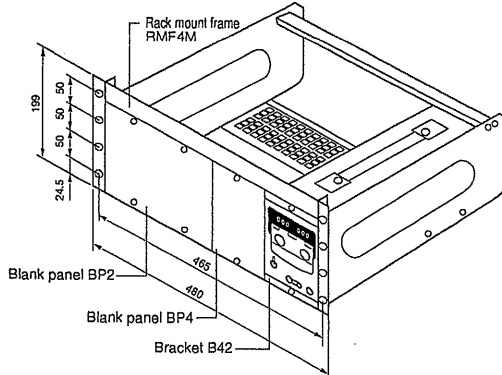

Fig. P-2A Model 175W mounted into RMF4M

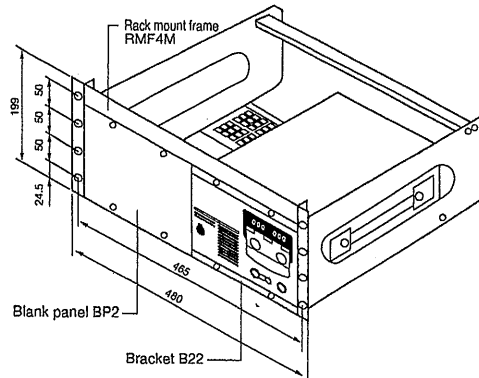

Fig. P-2A Model 700W(350W) mounted into RMF4M

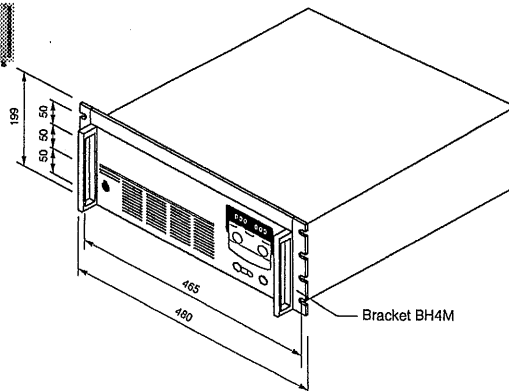

Fig. P-2C Model 1000W with BH4M mounted on it

## 1.1 Checks during unpacking

When you unpack the product, make sure that you have all the parts and that none have been damaged during transportation. If any parts is damaged or missing, contact your Kikusui agent.

Accessories vary depending on the model. Check with Fig. 1-1.



The model 175W includes the following accessories.



AC power cable



Operation manual



Guard cap

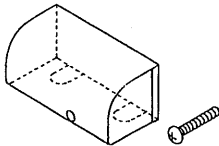

Auxiliary output terminal cover  
(Not included for the PAN16-10 and PAN35-5.)



Cable clammer  
(Mount on the unit.)



AC input terminal cover  
(Mount on the unit.)

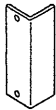

Rear output terminal cover  
(Mount on the unit.  
Not included for the PAN16-10 and PAN35-5.)

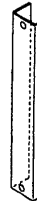

Control terminal cover  
(Mount on the unit.  
Not included for the PAN16-10 and PAN35-5.)

Fig. 1-1A Accessories (model 175W)



The model 350W includes the following accessories.

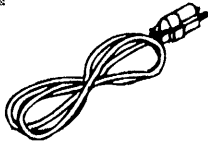

AC power cable



Fuse

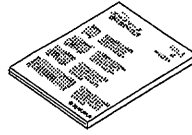

Operation manual



Guard cap

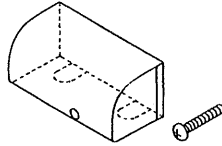

Auxiliary output terminal cover  
(Not included for the PAN16-18 and PAN35-10.)



Cable clammer  
(Mount on the unit.)

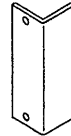

AC input terminal cover  
(Mount on the unit.)



PAN16-18

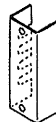

PAN55-6  
PAN70-5  
PAN110-3  
PAN160-2

Rear output terminal cover  
(Mount on the unit. Not included for the PAN35-10.)



Control terminal cover  
(Mount on the unit. Not included for the PAN16-18 and PAN35-10.)

Fig. 1-1B Accessories (model 350W)



The model 700W includes the following accessories.

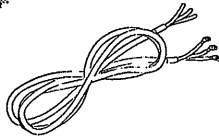

AC power cable



Fuse



Operation manual



Guard cap

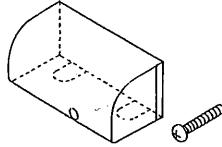

Auxiliary output terminal cover  
(Not included for the PAN16-30 and PAN35-20.)



Cable clammer  
(Mount on the unit.)

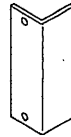

AC input terminal cover  
(Mount on the unit.)



PAN16-30  
PAN35-20



PAN55-10  
PAN70-8  
PAN110-5  
PAN160-3.5  
PAN250-2.5

Rear output terminal cover  
(Mount on the unit.)



Control terminal cover  
(Mount on the unit. Not included for the PAN16-30 and PAN35-20.)

Fig. 1-1C Accessories (model 700W)





The model 1000W includes the following accessories.

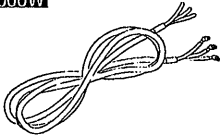

AC power cable



Operation manual



Guard cap

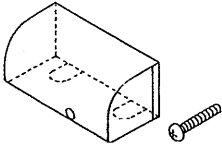

Auxiliary output terminal cover  
(Not included for the PAN16-50 and PAN35-30.)



Cable clammer  
(Mount on the unit.)

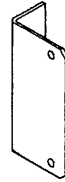

AC input terminal cover  
(Mount on the unit.)



Rear output terminal cover  
(Mount on the unit. Not included for the PAN16-50 and PAN35-30.)

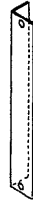

Control terminal cover  
(Mount on the unit. Not included for the PAN16-50 and PAN35-30.)

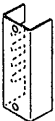

Sensing terminal cover  
(Mount on the unit. Not included for the PAN16-50 and PAN35-30.)

Fig. 1-1D Accessories (model 1000W)

## 1.2 Precautions for moving

To carry the unit, hold the handle as shown below. When moving the unit for a short distance, to the next room, for example, carry it on a wagon whenever available.

### WARNING

- For safety, check that the power switch is turned off.

### CAUTION

- When transporting the product, be sure to use the original packing materials. If they are missing, contact your Kikusui agent.
- When packing the product, remove the power cable and all other connection cables.



In the case of the model 175W, hold the handle located on the top.

Hold the handle.

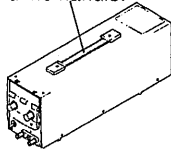

Fig. 1-2A Precaution for moving (model 175W)



In the case of the models 350W and 700W, the power transformer is located on the left seen from the front, and the center of gravity of the unit is deviated to the left. For carrying the unit, position the left side to be bottom first, and carry it with the handle.

Position the left side to the bottom.

Hold the handle.

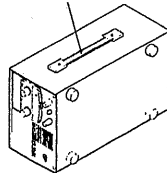
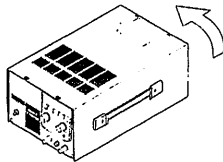

Fig. 1-2B Precaution for moving (models 350W and 700W)



1000W

In the case of the model 1000W, the power transformer is located on the left seen from the front, and the center of gravity of the unit is deviated to the left. For carrying the unit, take sufficient care.

For carrying, the front panel handles should be held by one person, and the rear panel handles by another person.

### WARNING

- The weight of the model 1000W exceeds 35 kg. To prevent any danger, never carry the unit by one person.

### NOTE

- Only for carrying, it is permissible to stand the unit as shown in Fig. 1-2C, and carry it by two persons, one each holding one front panel handle. After moving, quickly place the unit with its bottom underneath.

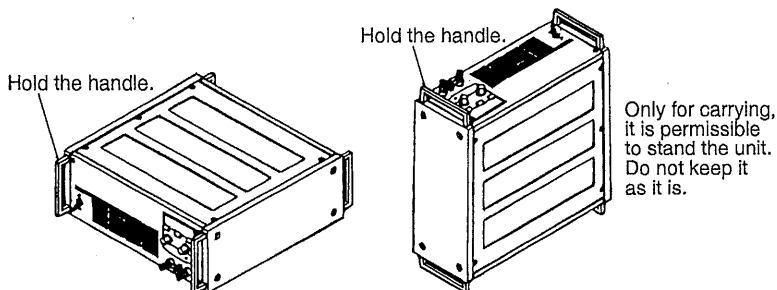

Fig. 1-2C Precaution for moving (model 1000W)

## 1.3 Precautions for installation

Be sure to observe the following precautions when installing the unit.

- Do not use the unit in a flammable atmosphere.

To prevent explosion or fire, do not use the unit near alcohol or thinner, or in an atmosphere containing such vapors.

- Avoid locations where the unit is exposed to high temperature or direct sunshine.

Do not locate the unit near a heater or in areas subject to drastic temperature changes.

Operation temperature range: 0 to 40°C

Storage temperature range: -10 to 60°C

- Avoid locations of high humidity.

Do not locate the unit in high-humidity locations, i.e., near a boiler, humidifier, water supply, etc.

Operation humidity range: 10 to 90% RH

Storage humidity range: 0 to 70% RH

Dew condensation may take place even in the operation humidity range. In such a case, do not use the unit until the dew dries up completely.

- Do not place the unit in a corrosive atmosphere.

Do not install the unit in a corrosive atmosphere or one containing sulfuric acid mist, etc. This may cause corrosion of various conductors and imperfect contact with connectors, malfunction and failure, or in the worst case, a fire.

- Do not locate the unit in a dusty location.

- Do not use the unit where ventilation is poor.

The unit employs a forced air cooling system. Air is taken in from intake ports located on the unit's sides and front, and is exhausted from the rear. Prepare sufficient space around the unit so that the intake ports and exhaust port are always completely unobstructed.

Do not install the unit with its front panel positioned upward or downward.

- Do not install the unit along a tilted section of floor or in a location subject to vibrations.

- Do not use the unit in locations affected by strong magnetic and/or electric fields.

## 1.4 Checking the input fuse (Only models 350W and 700W)

Use an input fuse element suitable for the AC power source. A seal is attached to the rear panel indicating suitable fuse ratings. See Fig. 1-3.

### WARNING

- To avoid electric shock, always disconnect the AC power cable or turn off the switch on the switchboard.

### CAUTION

- Select a fuse element of external design, rating and characteristics suitable for the unit. Use of a fuse of different rating or a short circuit of the fuse holder may damage the unit.

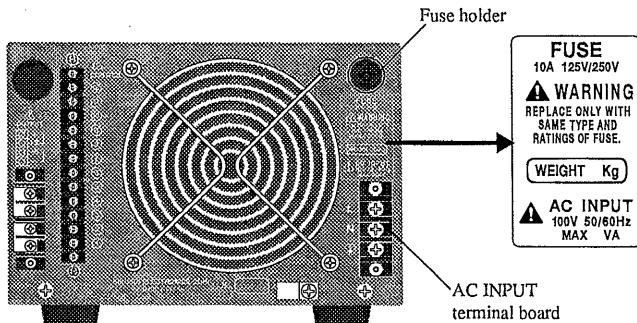

Fig. 1-3 Rear panel



The input fuses of the models 175W and 1000W are located inside, and users are not able to check or replace them.

### WARNING

- Users are requested to never remove the cover and check or replace the fuse.

## 1.5 Connecting the AC power cable

Connect the AC power cable to an AC power source specified for the unit. A seal is attached to the rear panel indicating the rated input. See Fig. 1-3.

### WARNING

- To avoid electric shock, first connect the cable to the AC INPUT terminal board before connecting it to the power source.

### Connecting procedure

- ① Remove the AC input terminal cover.
- ② Remove the cable clumper mounted on the rear panel.
- ③ Connect the supplied AC power cable to the terminal board as shown in Fig. 1-4.

### CAUTION

- Check that wires of specified color are connected to the specified terminals. See Fig. 1-4 for the correct connections.

### NOTE

- Fig. 1-4 shows the connections on the model 350W. Connections on other models can be performed in the same manner. However, the direction of mounting the cable clumper vary depending on the model.

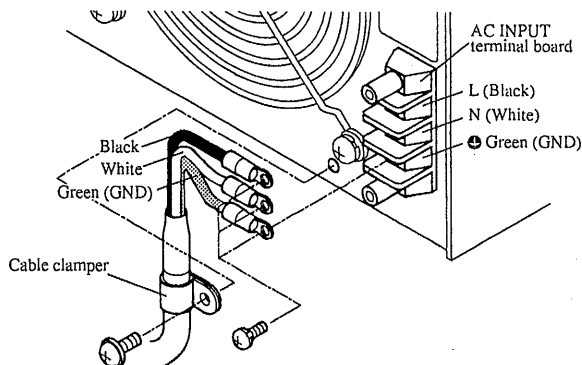
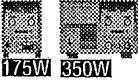

Fig. 1-4 Connection of AC power cable

- ④ Fasten the AC power cable with the cable clasper.
- ⑤ Mount the AC input terminal cover.



- ⑥ Connect the AC power cable to a power source receptacle.

### ■ Direct connection of power cable to the switchboard

The power cable is furnished with a 3-P plug on its AC power source end. For direct connection of the cable to the switchboard, cut off the plug, and crimp a terminal on each end of wire.

#### CAUTION

- Check the terminal screw on the switchboard, and crimp a terminal on each wire end suitable for the said terminal screw. (This connection must be performed by qualified personnel.)

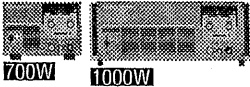

- ⑥ Connect the AC power source end of the AC power cable to the switchboard.

#### WARNING

- To prevent electric shock during cable connection, check that the switch of the switchboard is turned off.

#### CAUTION

- Each wire color of the cable has its corresponding terminal. Connect the wires to the distribution panel terminals in the same procedure as described in ③ above.
- Check the terminal screw on the switchboard, and crimp a terminal on each wire end suitable for the said terminal screw. (This connection must be performed by qualified personnel.)

## 1.6 Grounding

### WARNING

- Improper or no grounding may cause electrical shock.
- Connect the ground terminal to electrical ground (safety ground).

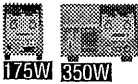

To ground the models 175W and 350W, three methods are available as described below. Select one of them, and securely ground the unit.

1. Remove the 3P-2P plug adapter from the AC power cable, and connect the 3-P plug to a grounded 3-P receptacle.
2. Keeping the 3P-2P plug adapter on the AC power cable, connect it to a 2-P receptacle, and ground the GND wire (green).
3. Cut off the plug, put a crimped terminal on the GND wire (green), and connect it to the grounding terminal on the switchboard.

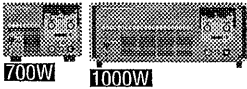

In the case of the models 700W and 1000W, securely connect the GND wire (green) of the power cable to the GND terminal of the switchboard.



## 2.1 Precautions and preparation for use

Before using the unit, users are requested to thoroughly understand the following matters.

### ■ Inrush current

A inrush current may flow when the POWER switch is turned on. See Table 2-1. If you are planning to use several sets of the unit in a system, and to turn on the POWER switches at the same time, check that the AC power source or the switchboard is of sufficient capacity. Keep 3 seconds or longer interval between ON and OFF of the POWER switch. Repeated ON/OFF at a shorter interval may cause inrush current and shorten the service lives of the input fuse and power switch.

Table 2-1 Inrush current of each model

	Model 175W	Model 350W	Model 700W	Model 1000W
Peak current range	100A to 150A	140A to 200A	300A to 400A	450A to 550A
Half-amplitude level	5ms	5ms	5ms	5ms

### ■ Negative voltage

Regardless of the OUTPUT switch's ON or OFF setting, when the VOLTAGE control or the CURRENT control is turned fully counter-clockwise, a negative voltage of 0-0.6 V is generated.

Affected by this voltage, approx. 10 mA reverse current flows to the load. In cases where the load will be affected by such a reverse current, carefully check the suitability of the application.

### ■ Output terminals on the front panel

The output terminals on the front panel are auxiliary output terminals. These terminals, however, may not satisfy the given specifications of the unit.



1000W  
PAN16-50

The PAN16-50 has no front panel output terminal.

## ■ Load

Note that the output may become unstable when one of the following loads is connected.

### 1. When load current has peaks or is pulse-shaped

The current meter on the unit indicates only mean values. Even when the indicated value is less than the maximum current, therefore, a peak may exceed the preset current value. In such a case, the unit is instantaneously put into constant-current operation mode, and the output voltage drops accordingly. If you look carefully, you will see the constant current (CC) indicator light up dimly.

For such a load, a larger value should be preset for the constant current, or the current capacity should be increased.

--- Constant current preset value  
 ..... Meter indication value (mean value)

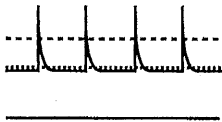

Fig. 2-1 Load current with peak value

--- Constant current preset value  
 ..... Meter indication value (mean value)

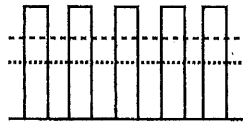
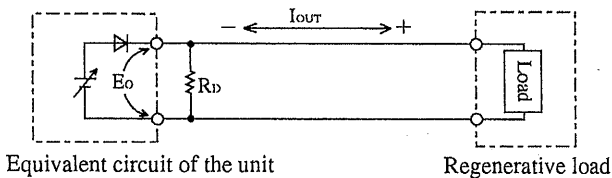

Fig. 2-2 Pulse-shaped load current

### 2. When a load generates a reverse current to the power supply

The unit cannot absorb a reverse current from a regenerative load such as an inverter, converter or transformer that supplies current to a power supply. Consequently, the output voltage will increase and the output will fluctuate.

As a remedy, connect a resistor  $R_D$  as shown in Fig. 2-3 to bypass the reverse current.



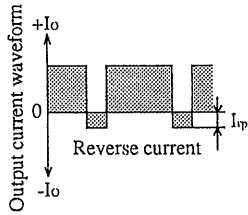

$$R_D [\Omega] \leq \frac{E_o [V]}{I_{rp} [A]}$$

where  $R_D$ : Reverse current bypass dummy load  
 $E_o$ : Output voltage  
 $I_{rp}$ : Max. reverse current

Fig. 2-3 Remedy for regenerative load

NOTE

- The amount of current to the load decreases by  $I_{rp}$ .

3. In case of load with accumulated energy, such as batteries  
 Connecting a load with accumulated energy, such as a battery, to the output of the unit may cause a large current to flow from the load through the internal output control circuit protection diode to the internal capacitor. Such currents may damage the internal components of the unit, and reduce the life of the load.

As a remedy, connect a reverse-current-prevention diode D between the unit and the load as shown in Fig. 2-4.

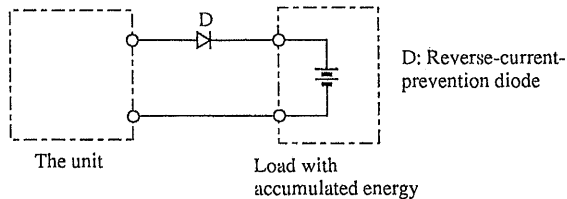

Fig. 2-4 Measures against load with accumulated energy

CAUTION

- To protect the unit and the load, select the reverse-current-prevention diode D according to the following standard.
  1. Reverse voltage withstand capacity: Minimum of twice the rated output voltage of the unit.
  2. Forward current capacity: Three to ten times the rated output current of the unit.
  3. A diode with small loss

## 2.2 Turning on the power

Before turning on the POWER switch, always check the status of the OUTPUT switch. Push in the OUTPUT switch to turn it on, and release it to turn it off.

### CAUTION

- If the POWER switch is turned on while the OUTPUT switch remains on, a preset voltage or current is supplied to the load.

### NOTE

- If the POWER switch is turned on while the OUTPUT switch remains on, AC ripple components may be superimposed at startup depending on the operation speed of the phase control circuit and the status of the load.

### Turning on the power procedure

- ① Check that the POWER switch is turned off.
  - ② Check that the OUTPUT switch is turned off.
  - ③ Check that the supplied AC power cable is correctly connected.
  - ④ Turn on the switch on the switchboard which supplies power to the unit, or connect the AC power cable plug to a receptacle.
  - ⑤ Turn on the POWER switch.
  - ⑥ The LED on the control panel lights up.
  - ⑦ While pressing the LIMIT switch, and turn the VOLTAGE control; check that the output voltage can be preset in a range from zero to the rated output voltage value.
  - ⑧ Continue pressing the LIMIT switch, and turn the CURRENT control; check that the output current can be preset in a range from zero to the rated output current value.
- Now, the unit is ready for use.

## 2.3 Basic operation

There are two different modes for the unit: constant voltage (CV) mode, and the constant current (CC) mode. Before starting to use the unit, determine which mode is to be employed, and select the procedure suitable for the selected operation mode.

### CAUTION

- To protect the load, preset the OVP trip point for either operation mode.

### 2.3.1 OVP trip point presetting

Using the LIMIT switch, an output-voltage limit value can be preset. By turning the VOLTAGE control, however, the output-voltage limit value can be changed at any time. Therefore, if you turn on the OUTPUT switch without first confirming the output-voltage limit value by using the LIMIT switch, an unexpectedly excessive voltage may be supplied to the load. To protect the load in such a case, the OVP (over-voltage protection) function is provided.

### CAUTION

- The OVP trip point is factory-preset to 110% of the rated output voltage of the unit. When using the unit, preset to an OVP trip point suitable for the load.

When the OVP function is active, an "ALM" (alarm) LED lights up on the control panel, and output is shut down. To release the alarm, turn off the OUTPUT switch, and turn on the POWER switch again. In this case, lower the output-voltage preset value. Otherwise the OVP function is activated again, if OUTPUT switch is turned on.

## Presetting the OVP trip point

### CAUTION

- After presetting the OVP trip point, be sure to check that the OVP function works at the preset voltage (Procedure ④ - ⑥). For checking, it is necessary to output an actual voltage. Therefore, first check that no load is connected, and proceed with the following procedure.
  - ① Turn off the OUTPUT switch.
  - ② Turn on the POWER switch.
  - ③ While presetting the PRESET OVP switch, turn the OVP control with a Phillips-head screwdriver, and preset to the over voltage against which the load is to be protected.
  - ④ Turn the VOLTAGE control fully counter-clockwise.
  - ⑤ Turn on the OUTPUT switch.
  - ⑥ Gradually turn the VOLTAGE control clockwise, and check that the "ALM" (alarm) LED lights up and the output is shut down when the output voltage has reached the preset OVP voltage.

Now, the OVP trip point presetting is completed.

## 2.3.2 Using as a constant voltage power source

### WARNING

- For safety, turn off the POWER switch when connecting the load.
- ① Check that the OUTPUT switch is turned off.
  - ② Turn on the POWER switch.
  - ③ While pressing the LIMIT switch, preset the requested current by turning the CURRENT control.

### NOTE

- This preset value functions as a current limit for constant voltage operation; no current larger than preset value will flow even with a sudden change in load resistance.
- ④ While pressing the LIMIT switch, preset the requested voltage by turning the VOLTAGE control.

### CAUTION

- A sudden input voltage is not desirable for any of the below-listed loads. For such loads, gradually increase the voltage from zero (i.e., turn the control from fully counter-clockwise).
    1. Loads of unknown resistance
    2. Loads whose resistance varies over a wide range
    3. Loads of large inductance
- ⑤ Turn on the OUTPUT switch.
  - ⑥ The "CV" LED lights up on the control panel to indicate that the unit is in constant voltage mode.

### 2.3.3 Using as a constant current power source

#### WARNING

- For safety, turn off the POWER switch when connecting the load.
- ① Check that the OUTPUT switch is turned off.
  - ② Turn on the POWER switch.
  - ③ While pressing the LIMIT switch, preset the requested voltage by turning the VOLTAGE control.

#### NOTE

- This preset value functions as a voltage limit for constant current operation; no voltage higher than the preset value will be output even with a sudden change in load resistance.
- ④ While pressing the LIMIT switch, preset the requested current by turning the CURRENT control.

#### CAUTION

- A sudden input current is not desirable for any of the below-listed loads. For such loads, gradually increase current from zero (i.e., turn the control from fully counter-clockwise).
    1. Loads of unknown resistance
    2. Loads whose resistance varies over a wide range
    3. Loads of large inductance
- ⑤ Turn on the OUTPUT switch.
  - ⑥ If a load is connected, the "CC" LED lights up on the control panel showing that the unit is in constant current mode.



## 2.4 Connecting load

### CAUTION

- The connection cable to the load (the load cable) should be of a sufficient capacity for the rated current.

### NOTE

- The output terminals of this unit are found in two locations, on the rear panel and the front panel. The terminals on the front panel, however, are for auxiliary purposes and may not satisfy the specified performance.
- Usually, connect the chassis ground terminal ( $\perp$ ) on the front panel to a - (neg.) output terminal or + (pos.) output terminal using the shorting bar.

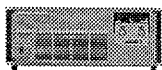

1000W  
PAN16-50

- The PAN16-50 has no front panel output terminal. The shorting bar to connect the output terminal to the chassis ground terminal ( $\perp$ ) is mounted on the rear panel output terminals.

### Load connection procedure

- ① Check that the POWER switch is turned off.
- ② Connect the load to the output terminals board on the rear panel or to the auxiliary output terminals on the front panel. See Figs. 2-5 and 2-6.

### NOTE



850W  
PAN16-18



700W  
PAN16-30  
PAN35-20

- For connecting a cable to the rear panel output terminals of the models shown on the left, see Fig. 2-7.

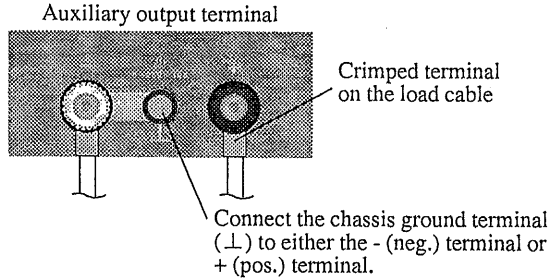

Fig. 2-5 Connection to the auxiliary output terminals on the front panel

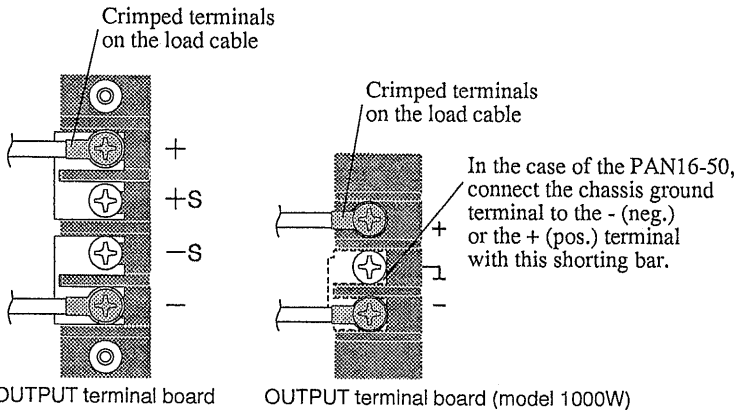
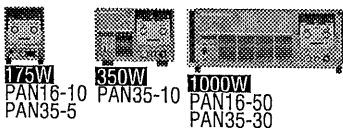

Fig. 2-6 Connection to the OUTPUT terminal board on the rear panel

### CAUTION

- To assure a good connection of the load cable to the output terminals, use crimped terminals.
- After connecting the load cable, mount the output terminal cover (on the front or rear panel). Note that certain models have no terminal cover.

To mount the front auxiliary output terminal cover, see section 2.5, "Mounting the auxiliary output terminal cover".



No cover is available and necessary for the front auxiliary output terminals and rear output terminals of the models shown on the left.

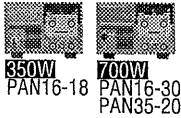

No cover is available and necessary for the front auxiliary output terminals of the models shown on the left.

■ Rear OUTPUT terminal board of the PAN16-18, PAN16-30, and PAN35-20

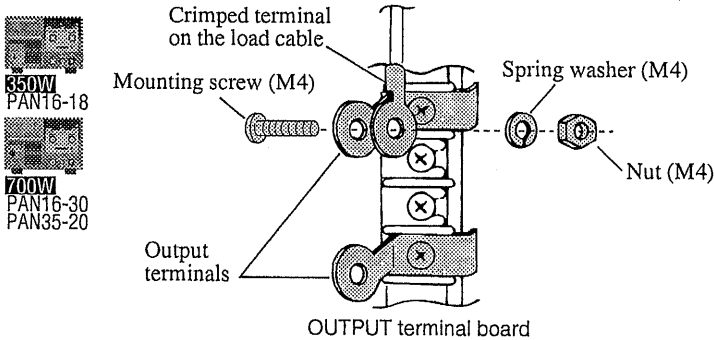

Fig. 2-7 Connection to the rear OUTPUT terminal board of the PAN16-18, PAN16-30, and PAN35-20

**CAUTION**

- To assure a good connection of the load cable to the output terminals, use crimped terminals.
- Be sure to use M4 screws to fasten the crimped terminals of the load cable to the output terminals, and fasten them as shown in Fig. 2-7.
- After connecting the load cable, mount the rear output terminal cover.
- The rear output terminals project from the terminal board. Check that nothing around the unit will contact the terminals.

**NOTE**

- Screws to fasten the crimped terminals of the load cable to the output terminals are not supplied with the unit.

## 2.5 Mounting the auxiliary output terminal cover

The unit is provided with a front auxiliary output terminal cover. Mount the cover when the unit is to be used. Note that certain models have no terminal cover.

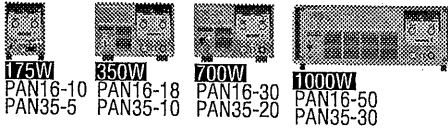

No cover is available and necessary for the front auxiliary output terminals of the models shown above.

### CAUTION

- To mount the cover, be sure to use the screws supplied. Other screws, if of an incorrect length, may contact some internal part of the unit.

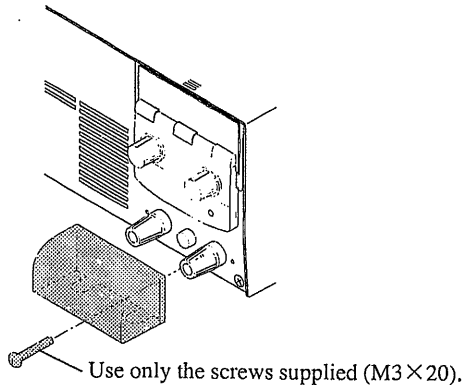

Fig. 2-8 Mounting the auxiliary output terminal cover

## 2.6 Fixing output presetting

The unit includes VOLTAGE and CURRENT controls; in order to make them mechanically fixed or semi-fixed, guard caps are supplied with the unit. Use them if output presetting is seldom necessary.

## Using the guard caps

- ① Check that the OUTPUT switch is turned off.
- ② Turn on the POWER switch.
- ③ While pressing the LIMIT switch, preset the output level (voltage and/or current) to a desired value. Here, a rough presetting is acceptable.
- ④ Pull out the VOLTAGE and/or CURRENT control (knob) without turning it.
- ⑤ While pressing the LIMIT switch, use a flat-head screwdriver, and preset the output to a desired value.

### ■ To fix presetting

- ⑥ Push in the guard cap, instead of the removed knob.

### ■ To semi-fix presetting

- ⑥ As shown in Fig. 2-9, pierce the guard cap top with a Phillips-head screwdriver.
- ⑦ Push in the guard cap, instead of the removed knob. Since the guard cap is pierced, the output level may be readjusted using a flat-head screwdriver.

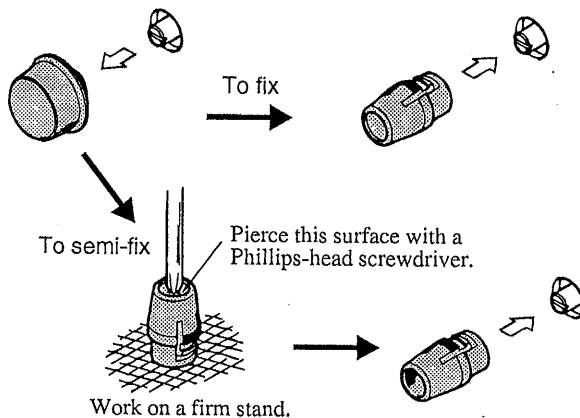

Fig. 2-9 Mounting the guard cap

## Re-mounting the knob

There is a slot on the end of the shaft of the output preset potentiometer. Mount the knob so that it engages the slot to prevent the knob from turning freely. Follow the procedure described below.

- ① Remove the guard cap pressing the two locking mechanisms.
- ② Press in the knob till it softly touches the shaft of the potentiometer.

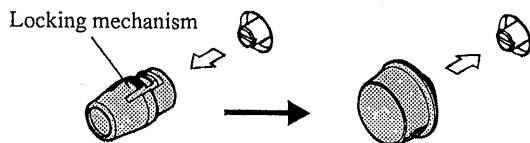

Fig. 2-10 Removing the guard cap

- ③ Using gentle force, turn the knob fully counter-clockwise.
- ④ Pressing the knob, turn it further counter-clockwise until it settles in deeply, and the knob and shaft are engaged.

### 3.1 Remote sensing

The remote sensing function is intended to reduce the influence of voltage drops affected by the load cable resistance, to keep the output voltage stable at the load terminal. To perform remote sensing, an electrolytic capacitor that has good frequency characteristics is needed at the sensing point (load terminal).

#### Connecting procedure

- ① Turn off the OUTPUT switch.
- ② Turn off the POWER switch.
- ③ As shown in Fig. 3-1A, remove the sensing shorting bar.

#### NOTE



• For the model 1000W user, see Fig. 3-1B.

- ④ Connect the +S terminal and the + (pos.) terminal of the load, and connect the -S terminal and the - (neg.) terminal of the load.
- ⑤ Connect electrolytic capacitors (C1, C2) across the +S terminal and the + (pos.) terminal, and across the -S terminal and the - (neg.) terminal.
- ⑥ Connect an electrolytic capacitor (C) with a capacity of approx. 1,000 to 100,000  $\mu$  F across the load terminals.

#### CAUTION

- If the sensing wire is disconnected, the output voltage at the load terminals cannot be stabilized, and excessive voltage may be applied to the load. To assure good connection to the output terminals, use crimped terminals.
- After connection, mount the rear output terminal cover.

Note that certain models have no terminal cover.



175W  
PAN16-10  
PAN35-5



350W  
PAN35-10



1000W  
PAN16-50  
PAN35-30

No cover is available and necessary for the rear output terminals of the models shown on the left.

### NOTE

- To decrease output ripple voltages caused by inductive effect, use a shielded wire for sensing. Connect the shield to the + (pos.) terminal.

- ⑦ Check again that all the cables and wires are connected correctly.

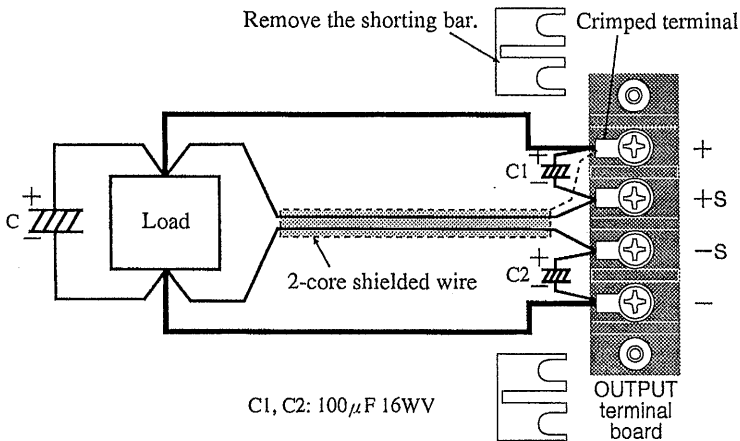

Fig. 3-1A Remote sensing connection

### CAUTION

- After using the remote sensing, remove the sensing wire, and be sure to connect the sensing shorting bars across the +S and + (pos.) terminals, and -S and - (neg.) terminals.



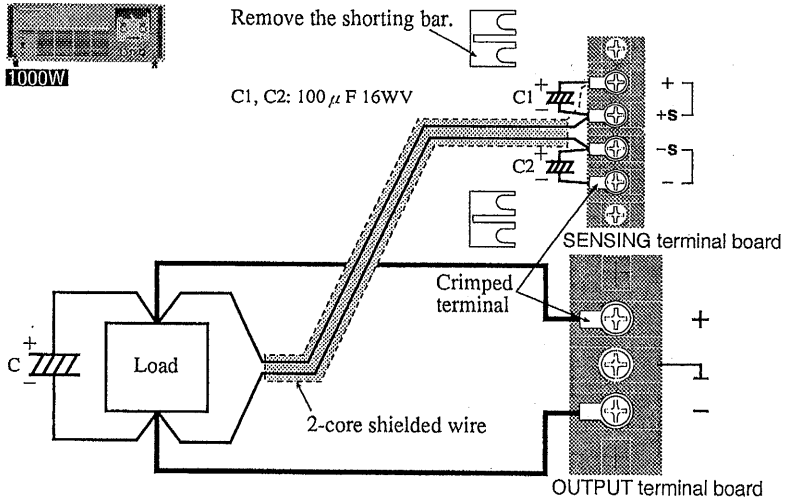

Fig. 3-1B Remote sensing connection (model 1000W)

### CAUTION

- Do not connect any load to + (pos.) and - (neg.) terminals on the SENSING terminal board.
- After connection, mount the sensing terminal cover. Note that certain models have no terminal cover.  
No cover is available and necessary for the sensing terminal of the PAN16-50 and PAN35-30.
- After using the remote sensing, remove the sensing wire, and be sure to connect the sensing shorting bars across the +S and + (pos.) terminals, and -S and - (neg.) terminals on the SENSING terminal board.

## 3.2 Analog remote control

It is possible to remotely control the unit's output voltage and current using analog signals. Output of ON/OFF operation by means of external contact points is also possible.

The above-mentioned remote of controls can be used in combination, but note the following exceptions.

- Combination of output voltage control using external resistor and output voltage control using external voltage.
- Combination of output current control using external resistor and output current control using external voltage.

### **WARNING**

- Incorrect handling of the CONTROL terminal board may cause electric shock or accidents due to short circuit of the output. When using remote control, always follow the procedures for each corresponding control method.
- The common line for the internal control circuit of the unit is connected to the + (pos.) output terminal inside. Therefore, the potential of the common terminal of the CONTROL terminal board, resistors, voltage source and switch to be connected to the CONTROL terminal board are nearly the same as that of the + (pos.) output terminal.

## ■ Before performing analog remote control

The unit is factory-calibrated for control from the front panel (i.e., local control). Before using remote control (excluding output of ON/OFF using external contact points), re-calibration is necessary. Re-calibration is also necessary when changing from remote control back to local control. For details on calibration, see section 5.3, "Calibration".

Table 3-1 Alignment on CONTROL terminal board

No.	Signal name	Description
⑫	M/S CONT OUT	Master unit output for master-slave control parallel connection
⑪	SLAVE IN	Slave unit input for master-slave control parallel connection
⑩	M/S CONT COM	Common line for master-slave control parallel connection
⑨	OUTPUT ON/OFF	Output ON/OFF control
⑧	D COM	Common line for internal control circuit
⑦	CC R CONT IN	Input for output current control using external resistor
⑥	CC R CONT OUT	Output for output current control using external resistor
⑤	CC V CONT	Input for output current control using external voltage
④	CV R CONT IN	Input for output voltage control using external resistor
③	CV R CONT OUT	Output for output voltage control using external resistor
②	CV V CONT	Input for output voltage control using external voltage
①	A COM	Common line for internal control circuit

A COM and D COM are connected to the + (pos.) terminal inside.

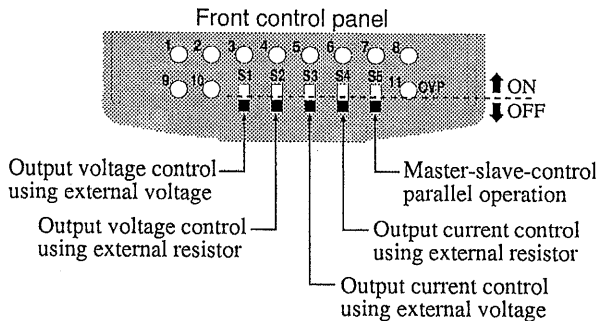

Fig. 3-2 Alignment of control switches

### 3.2.1 Controlling output voltage with external resistor

This method is used to control output voltage using a 0-approx. 10 k  $\Omega$  external resistor.

#### WARNING

- To avoid electric shock, insulate the external resistor (Rext) from the others. The potential of Rext is nearly the same as that of the unit's + (pos.) output terminal. If the - (neg.) output terminal is connected to the chassis ground terminal ( $\perp$ ) and Rext is left non-insulated, there may be a danger of electric shock and accidents due to a short circuit of the output across the chassis (case) of the unit and Rext.

#### Connection and setup procedure

- ① Turn off the OUTPUT switch.
- ② Turn off the POWER switch.
- ③ Set the control switches S1 and S2 as shown in Fig. 3-3.
- ④ Connect an external resistor across the control terminals ③ and ④ as shown in Fig. 3-3.

#### CAUTION

- If Rext is disconnected, a voltage higher than the rated level is output. To ensure a firm connection to the control terminals, use crimped terminals.
- To use Rext which consists of a multiple number of fixed resistors and a switch, and select one of them for control, use a short circuit type or continuous type switch.
- After connection, mount the control terminal cover. Note that certain models have no terminal cover.



No control terminal cover is available and necessary for the models shown above.

NOTE

- To minimize the influence of noise on the output, use a 2-core shielded wire or a twisted-pair wire to connect the control terminals and Rext. If using a shielded wire, connect the shield to the terminal ①.
  - Approx. 1 mA of current always flows in Rext. For Rext, use a 1/2 W or larger metal film or wire-wound type resistor with a good temperature coefficient and small aging effect.
- ⑤ Re-check that the connections on the terminal board and the switch settings are correct.

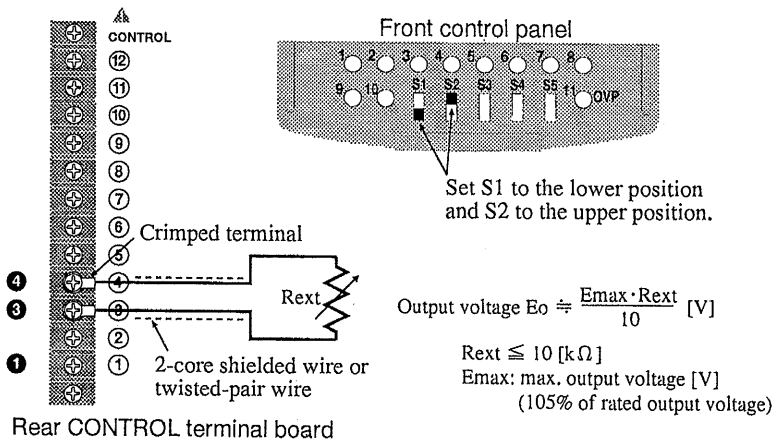

Fig. 3-3 Connection and setup for output voltage control using external resistor

### 3.2.2 Controlling output voltage with external voltage

This method is used to control output voltage using 0- approx. 10 V.

#### WARNING

- To avoid electric shock, insulate the external voltage source (Vext) from the others. The potential of Vext is nearly the same as that of the unit's + (pos.) output terminal.

If the - (neg.) output terminal is connected to the chassis ground terminal ( $\perp$ ) and the output of Vext is connected to the Vext case, there may be a danger of electric shock and accidents due to a short circuit of the output across the chassis (case) of the unit and the Vext case.

#### Connection and setup procedure

- ① Turn off the OUTPUT switch.
- ② Turn off the POWER switch.
- ③ Turn the VOLTAGE control fully clockwise.

#### NOTE

- In output voltage control using external voltage, it is also possible to change the output using the VOLTAGE control. Therefore, keep the control turned fully clockwise so that output voltage can be remotely controlled, up to the rated output voltage. If output preset on the panel needs to be fixed, use the supplied guard cap.
- ④ Set the control switches S1 and S2 to the position shown in Fig. 3-4.
  - ⑤ Connect the voltage source across the control terminals ① and ② as shown in Fig. 3-4.

#### CAUTION

- Watch the polarity of Vext. Connection at incorrect polarity may damage the unit.
- If Vext is disconnected, an unexpected voltage may be supplied by external noise. To assure a good connection

to the control terminals, use crimped terminals.

- After connection, mount the control terminal cover. Note that certain models have no terminal cover.

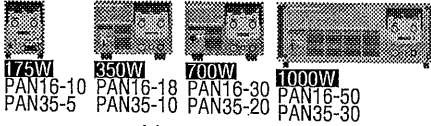

No control terminal cover is available and necessary for the models shown above.

NOTE

- To minimize the influence of noise on the output, use a 2-core shielded wire or a twisted-pair wire to connect the control terminals and Vext. If using a shielded wire, connect the shield to the terminal ①.
  - The input impedance across the control terminals ① and ② is approx. 10 k Ω.
  - For Vext, use a voltage source of low noise and good stability.
- ⑥ Re-check that the connections on the terminal board and the switch settings are correct.

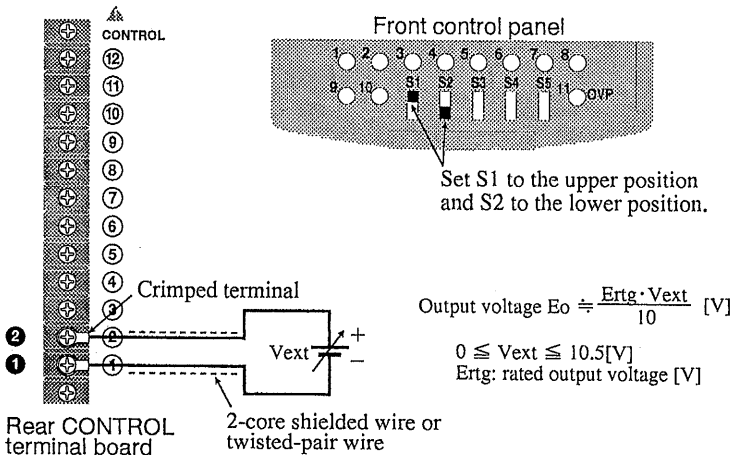

Fig. 3-4 Connection and setup for output voltage control using external voltage

### 3.2.3 Controlling output current with external resistor

This method is used to control output current using a 0- approx. 10 k $\Omega$  external resistor.

#### WARNING

- To avoid electric shock, insulate the external resistor (Rext) from the others. The potential of Rext is nearly the same as that of the unit's + (pos.) output terminal. If the - (neg.) output terminal is connected to the chassis ground terminal ( $\perp$ ) and Rext is left non-insulated, there may be a danger of electric shock and accidents due to a short circuit of the output across the chassis (case) of the unit and Rext.

#### Connection and setup procedure

- ① Turn off the OUTPUT switch.
- ② Turn off the POWER switch.
- ③ Set the control switches S3 and S4 to the position as shown in Fig. 3-5.
- ④ Connect an external resistor across the control terminals ⑥ and ⑦ as shown in Fig. 3-5.

#### CAUTION

- If Rext is disconnected, the internal current detection circuit functions to shut off the output, but a current higher than the rated level is output before the circuit starts functioning. To assure a good connection to the control terminals, use crimped terminals.
- To use Rext which consists of a multiple number of fixed resistors and a switch, and select one of them for control, use a short circuit type or continuous type switch.
- After connection, mount the control terminal cover. Note that certain models have no terminal cover.



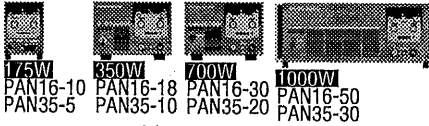

No control terminal cover is available and necessary for the models shown above.

NOTE

- To minimize the influence of noise on the output, use a 2-core shielded wire or a twisted-pair wire to connect the control terminals and Rext. If using a shielded wire, connect the shield to the terminal ①.
- Approx. 0.4 mA of current always flows in Rext. For Rext, use a 1/2 W or larger metal film or wire-wound type resistor with a good temperature coefficient and small aging effect.

⑤ Re-check that the connections on the terminal board and the switch settings are correct.

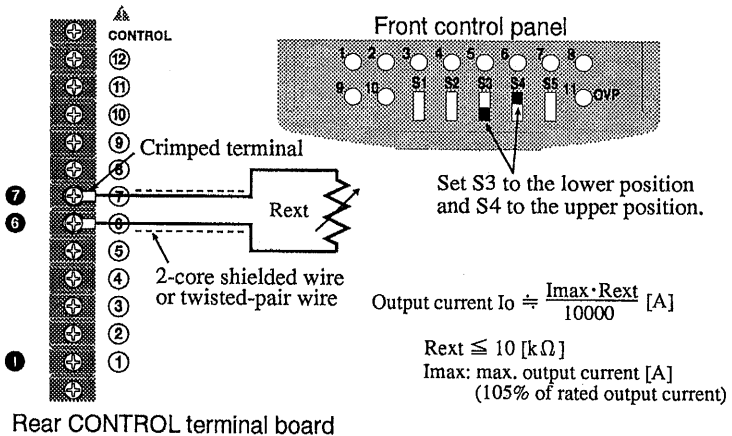

Fig. 3-5 Connection and setup for output current control using external resistor

### 3.2.4 Controlling output current with external voltage

This method is used to control output current using 0-approx. 10 V.

#### WARNING

- To avoid electric shock, insulate the external voltage source (Vext) from the others. The potential of Vext is nearly same as that of the unit's + (pos.) output terminal. If the - (neg.) output terminal is connected to the chassis ground terminal ( $\perp$ ) and the output of Vext is connected to the Vext case, there may be a danger of electric shock and accidents due to a short circuit across the chassis (case) of the unit and the Vext case.

#### Connection and setup procedure

- ① Turn off the OUTPUT switch.
- ② Turn off the POWER switch.
- ③ Turn the CURRENT control fully clockwise.

#### NOTE

- In output current control using external voltage, it is also possible to change the output using the output CURRENT control. Therefore, keep the control turned fully clockwise so that output current can be remotely controlled, up to the rated output current. If the output preset on the panel needs to be fixed, use the supplied guard cap.
- ④ Set the control switches S3 and S4 to the position as shown in Fig. 3-6.
  - ⑤ Connect the voltage source across the control terminals ① and ⑤ as shown in Fig. 3-6.

#### CAUTION

- Watch the polarity of the external voltage source (Vext). Connection at an incorrect polarity may damage the unit.
- To assure a good connection to the control terminals,

use crimped terminals.

- After connection, mount the control terminal cover. Note that certain models have no terminal cover.

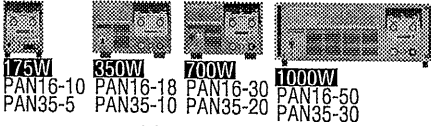

No control terminal cover is available and necessary for the models shown above.

NOTE

- To minimize the influence of noise on the output, use a 2-core shielded wire or a twisted-pair wire to connect the control terminals and Vext. If using a shielded wire, connect the shield to the terminal ①.
- The input impedance across the control terminals ① and ⑤ is approx. 25 k Ω .
- For Vext, use a voltage source of low noise and good stability.

- ⑥ Re-check that the connections on the terminal board and the switch settings are correct.

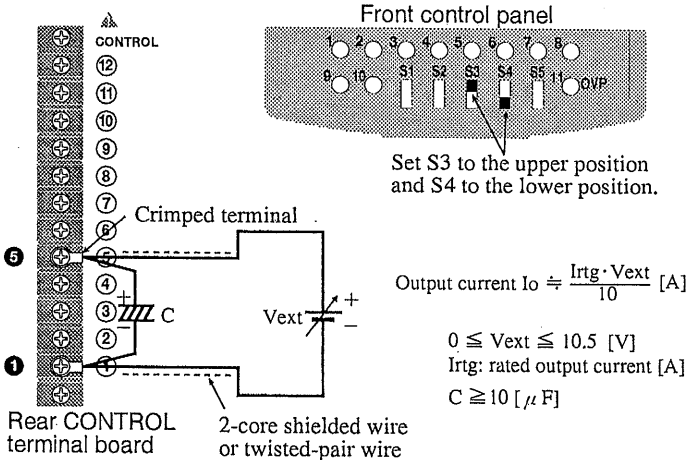

Fig. 3-6 Connection and setup for output current control using external voltage

### 3.2.5 Output ON/OFF control

This method is used to control the output's ON/OFF status using external contact points. Output is turned off when the external contact points are closed.

#### WARNING

- To avoid electric shock, insulate the external contact points (S) from the others. The potential of the contact points is nearly the same as that of the unit's + (pos.) output terminal.

If the - (neg.) output terminal is connected to the chassis ground terminal ( $\perp$ ) and the external contact points are not insulated, there may be a danger of electric shock and accidents due to a short circuit of the output across the chassis (case) of the unit and the external contact points.

#### CAUTION

- A negative voltage of approx. 0.6 V is generated when the output is turned off, and a reverse current of approx. 10 mA may flow.

#### NOTE

- In output of ON/OFF, "OFF" has higher priority. Therefore, always set the OUTPUT switch to ON so that ON/OFF control using external contact points can be performed.

### Connection and setup procedure

- ① Turn off the OUTPUT switch.
- ② Turn off the POWER switch.
- ③ Connect the contact points S (switch) across the control terminals ⑧ and ⑨ as shown in Fig. 3-7.

#### CAUTION

- To assure a good connection to the control terminals, use crimped terminals.
- After connection, mount the control terminal cover.

Note that certain models have no terminal cover.

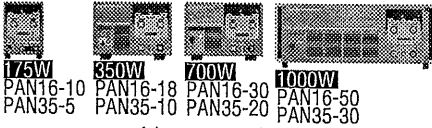

No control terminal cover is available and necessary for the models shown above.

NOTE

- To minimize the influence of noise on the output, use a 2-core shielded wire or a twisted-pair wire to connect the control terminals and the external contact points. If using a shielded wire, connect the shield to the terminal ⑧.
- The control terminal ⑧ is "common" for the control circuit. It is internally connected to +S on the unit.
- The release voltage across the control terminals ⑧ and ⑨ is approx. 5 V, and the short circuit current is approx. 1.5 mA.
- Use external contact points of rated 10 VDC min. and 10 mA min.

- ④ Re-check that the connections on the terminal board and the switch settings are correct.

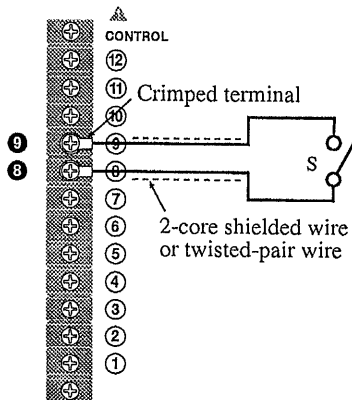

Rear CONTROL terminal board

Fig. 3-7 Output ON/OFF control connection

### 3.3 Master-slave-control parallel operation

It is possible to increase the current capacity by connecting a maximum two slave units in parallel to one master unit. In a master-slave-control parallel operation system, the output preset for all the units connected in parallel can be provided only on the master unit.

To perform such master-slave-control parallel operation, an electrolytic capacitor having good frequency characteristics should be connected to the load terminals.

#### CAUTION

- Only units of the same model and type can be connected in parallel. Connection of mixed models and types of units may cause a failure.
- Perform parallel operation only when using the master-slave-control parallel operation system. Parallel connection of output alone may cause unit failure.

#### Connection and setup procedure

- ① Turn off the OUTPUT switch of each unit.
- ② Turn off the POWER switch of each unit.
- ③ Determine the master unit.
- ④ Set the control switch S5 of the master unit and slave units to the positions shown in Fig. 3-8.

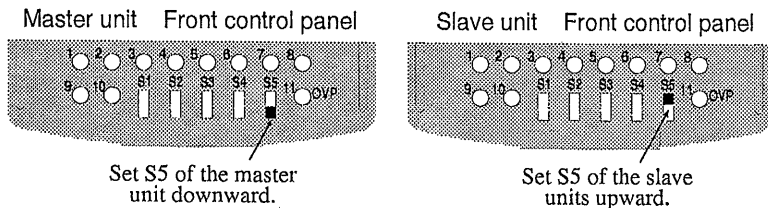

Fig. 3-8 Control switch presetting for master-slave-control parallel operation

- ⑤ Connect the master unit and slave unit as shown in Fig. 3-9A. Fig. 3-9A shows an example of how the rear output terminals are connected in parallel for two slave units

NOTE



1000W

- For the model 1000W user, see Fig. 3-9B.

CAUTION

- Use a load cable of sufficient current capacity to cover the rated value.
- Use wires of the same length and size for connecting the load and each unit. Use of varying lengths and size may cause different output current from each unit.
- To assure good connection of load cables and control wires, use crimped terminals.
- After parallel connection, mount the output terminal cover (on the front or rear panel). Note that certain models have no terminal cover.

To mount the front auxiliary output terminal cover, see section 2.5, "Mounting the auxiliary output terminal cover".



175W  
PAN16-10  
PAN35-5



350W  
PAN35-10



1000W  
PAN16-50  
PAN35-30

No cover is available and necessary for the front auxiliary output terminals and rear output terminals of the models shown on the left.



350W  
PAN16-18



700W  
PAN16-30  
PAN35-20

No cover is available and necessary for the front auxiliary output terminals of the models shown on the left.

- Position each unit with sufficient space around it. Do not stack units a top one another.

————— NOTE —————

- When performing remote sensing in master-slave-control parallel operation, prepare the sensing wiring only for the master unit. For information on connection, see section 3.1, "Remote sensing".
- If both parallel operation and remote sensing are required, the error in the current display of slave units may increase. In this case, use the slave units in sensing mode.



- The rear output terminal of the models shown on the left has a different shape from that of the unit shown in Fig. 3-9A. For information on load cable connection, see section 2.4 "Connecting load".

- ⑥ Connect an electrolytic capacitor (C) with a capacity of approximately 1,000 to 100,000  $\mu$  F to the load terminals as necessary.

————— NOTE —————

- When long cables and wires are used, the phase shift due to inductance and capacitance may become nonnegligible, thereby causing oscillation. In such cases, the capacitor (C) prevents oscillation.
- ⑦ Re-check that the connections and the switch settings are correct.



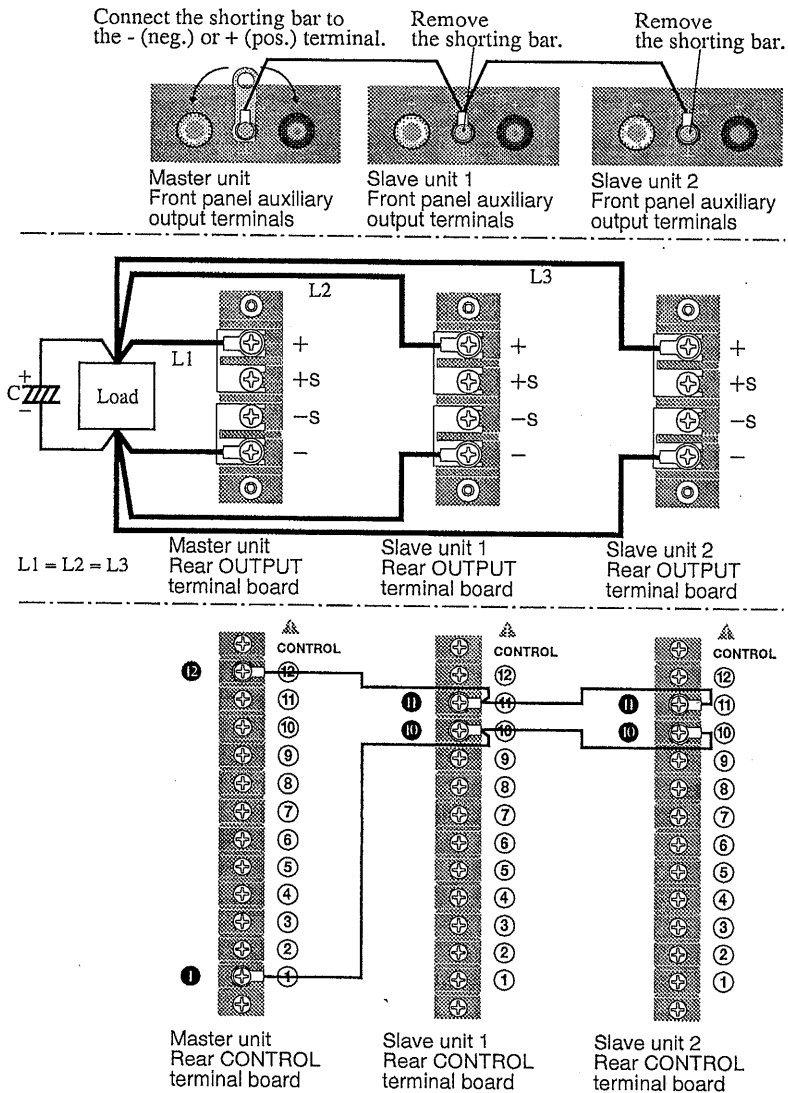

Fig. 3-9A Connection for master-slave-control parallel operation



1000W

Connect the shorting bar to the - (neg.) or + (pos.) terminal.

Remove the shorting bar.

Remove the shorting bar.

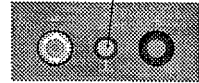
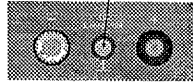
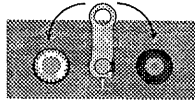

Shorting bar for grounding chassis of PAN16-50

Master unit  
Front panel auxiliary  
output terminals

Slave unit 1  
Front panel auxiliary  
output terminals

Slave unit 2  
Front panel auxiliary  
output terminals

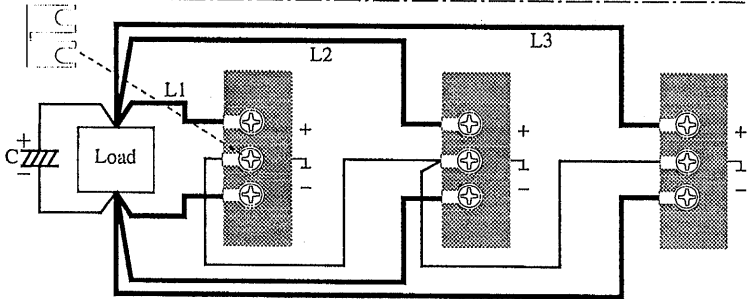

$L1 = L2 = L3$

Master unit  
Rear OUTPUT  
terminal board

Slave unit 1  
Rear OUTPUT  
terminal board

Slave unit 2  
Rear OUTPUT  
terminal board

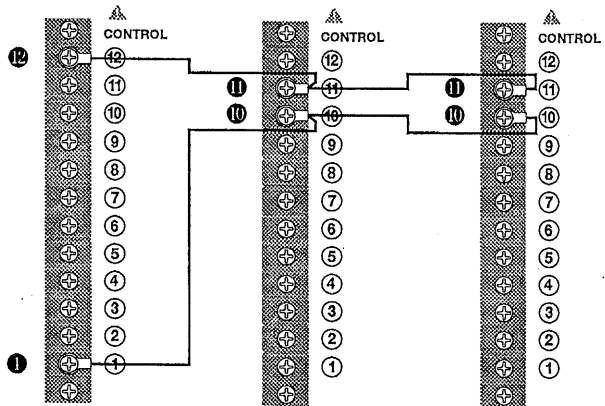

Master unit  
Rear CONTROL  
terminal board

Slave unit 1  
Rear CONTROL  
terminal board

Slave unit 2  
Rear CONTROL  
terminal board

Fig. 3-9B Connection for master-slave-control parallel operation (model 1000W)

## Master-slave-control parallel operation procedure

- ① Check that the OUTPUT switch of each unit is turned off.
- ② Turn on the POWER switch of the master unit.
- ③ Turn on the POWER switch of each slave unit.
- ④ Turn the VOLTAGE control and the CURRENT control of each slave unit fully clockwise.

### NOTE

- Preset the output of each slave unit to the maximum level, so that it can follow the preset output of the master unit.
- ⑤ While presetting the LIMIT switch of the master unit, preset the output voltage and current.

### NOTE

- The total output current setup value can be found by multiplying the preset value of the master unit by the number of units used for the parallel operation.
- ⑥ Turn on the OUTPUT switch of each slave unit.
  - ⑦ "CC" lights up on the control panel of each slave unit, indicating that the unit is in constant current operation mode.
  - ⑧ Turn on the OUTPUT switch of the master unit.
  - ⑨ "CV" lights up on the master unit control panel, indicating that the unit is in constant voltage operation mode.
  - ⑩ The same output voltage and current displayed on the master unit are also displayed on all the slave units. This means that the total current of all the units is applied to the load.

### 3.4 Master-slave-control series operation

It is possible to increase the output voltage by connecting several slave units in series to one master unit. In a master-slave-control series operation system, a preset output for all the units connected in series can be designated only from the master unit.

Number of units connectable in series:

The number of slave units to be connected in series is determined by the rated output voltage and isolation voltage of each unit.

Taking the PAN35-10 as an example for series connection:

Since the rated output voltage is 35 V, and the isolation voltage is  $\pm 250$  V,  $250/35 = 7.1$ , i.e., up to 7 units including the master unit can be connected in series.

#### WARNING

- Be sure to observe the limitation on the maximum number of units that can be connected in series. If the maximum output voltage exceeds the isolation voltage, it may create a danger of electric shock.
- To avoid electric shock, insulate the external resistor (Rext) from the others. The potential of Rext is nearly the same as that of the unit's + (pos.) output terminal.

#### CAUTION

- Only units of the same model and type can be connected in series. Connection of mixed models and types of units may cause a failure.
- Perform series operation only when using the master-slave-control series operation system. Serial connection of output alone may cause unit failure.

#### Connection and setup procedure

- ① Turn off the OUTPUT switch of each unit.
- ② Turn off the POWER switch of each unit.
- ③ Determine the master unit.
- ④ Set the control switch S1 of the master unit and slave units to the positions shown in Fig. 3-10.

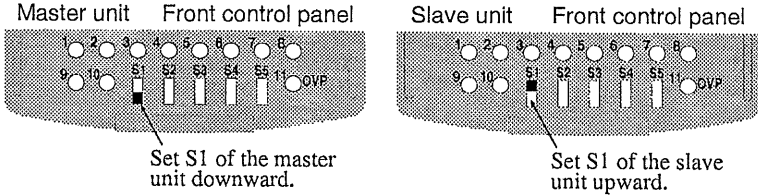

Fig. 3-10 Presetting of control switches for master-slave-control series operation

- ⑤ Connect the master unit and slave units shown in Fig. 3-11A. Fig. 3-11A shows an example of how the rear output terminals are connected in series for two slave units.

NOTE



**1000W**

- For the model 1000W user, see Fig. 3-11B.

CAUTION

- Use a load cable of sufficient current capacity to cover the rated value.
- To assure good connection of load cables and control wires, use crimped terminals.
- After series connection, mount the output terminal cover (on the front or rear panel). Note that certain models have no terminal cover.

To mount the front auxiliary output terminal cover, see section 2.5, "Mounting the auxiliary output terminal cover".



**175W**  
PAN16-10  
PAN35-5



**350W**  
PAN35-10



**1000W**  
PAN16-50  
PAN35-30

No cover is available and necessary for the front auxiliary output terminals and rear output terminals of the models shown on the left.



**350W**  
PAN16-18



**700W**  
PAN16-30  
PAN35-20

No cover is available and necessary for the front auxiliary output terminals of the models shown on the left.

- Position each unit with sufficient space around it. Do not stack units a top one another.

————— NOTE —————

- For Rext, use a 1 W or larger metal film or wire-wound type resistor with a good temperature coefficient and small aging effect.
- For performing remote sensing in master-slave-control series operation, prepare wiring for sensing using the +S terminal of the master unit, and the -S terminal of the slave unit connecting to the load (i.e., slave unit-2 in Fig. 3-11). For information on remote sensing connection, see section 3.1, "Remote sensing".

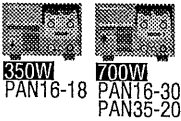

- The rear output terminal of the models shown on the left has a different shape from that of the unit shown in Fig. 3-11A. For information on load cable connection, see section 2.4 "Connecting load".

- ⑥ Re-check that the connections and the switch settings are correct.

Connect the shorting bar to the - (neg.) or + (pos.) terminal.

Remove the shorting bar.

Remove the shorting bar.

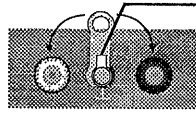

Master unit  
Front panel auxiliary  
output terminals

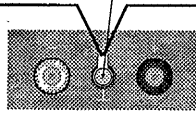

Slave unit 1  
Front panel auxiliary  
output terminals

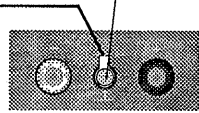

Slave unit 2  
Front panel auxiliary  
output terminals

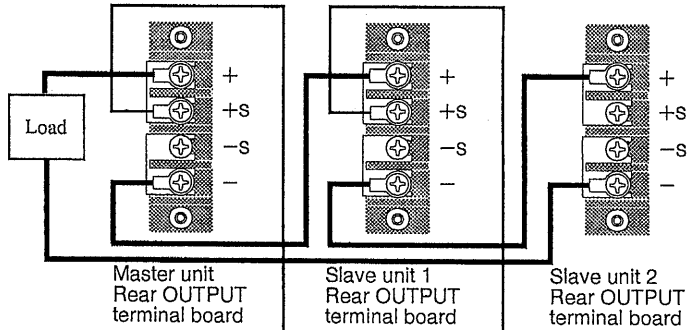

Master unit  
Rear OUTPUT  
terminal board

Slave unit 1  
Rear OUTPUT  
terminal board

Slave unit 2  
Rear OUTPUT  
terminal board

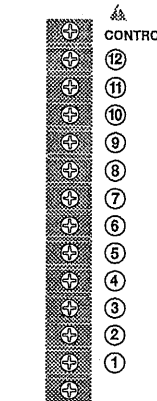

Master unit  
Rear CONTROL  
terminal board

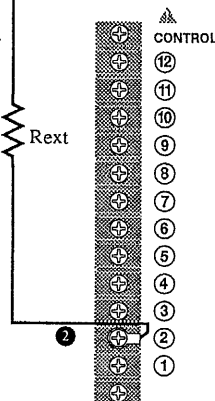

Slave unit 1  
Rear CONTROL  
terminal board

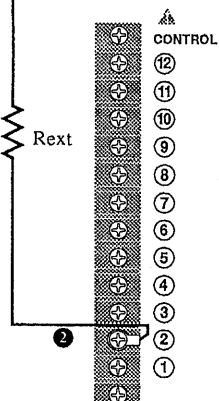

Slave unit 2  
Rear CONTROL  
terminal board

$$R_{ext} \approx (E_{rtg} - 10) \times 1000 [\Omega]$$

$E_{rtg}$ : rated output voltage of master unit

Fig. 3-11A Connection for master-slave-control series operation

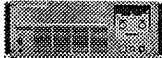

1000W

Connect the shorting bar to the - (neg.) or + (pos.) terminal.

Remove the shorting bar.

Remove the shorting bar.

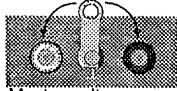

Master unit  
Front panel auxiliary  
output terminals



Slave unit 1  
Front panel auxiliary  
output terminals

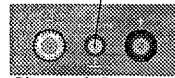

Slave unit 2  
Front panel auxiliary  
output terminals

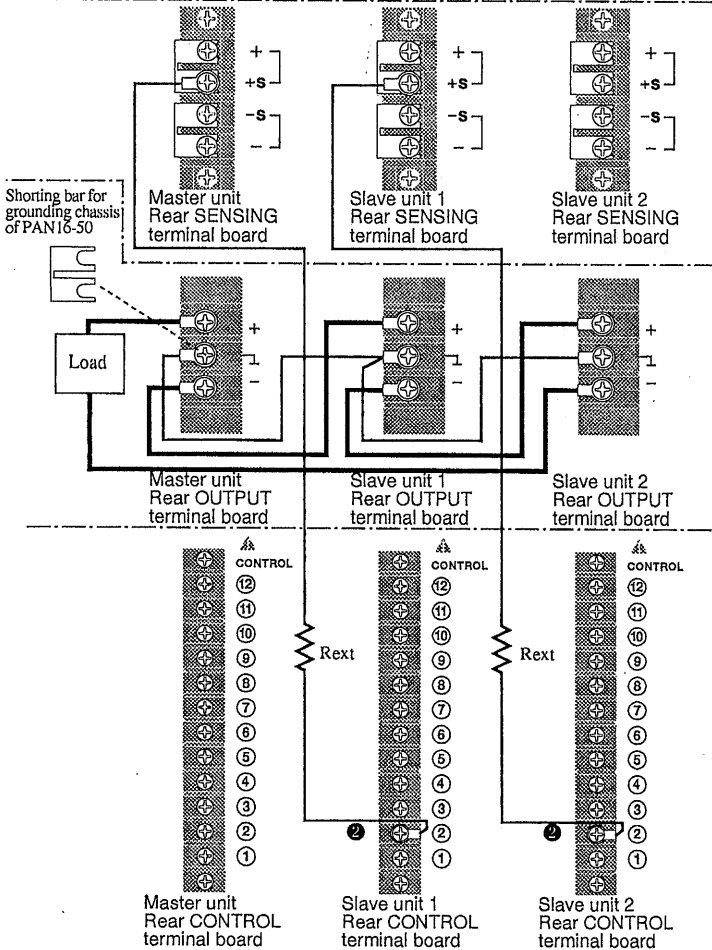

$$R_{ext} \approx (\text{Ertg} - 10) \times 1000 [\Omega]$$

Ertg: rated output voltage of master unit

Fig. 3-11B Connection for master-slave-control series operation (model 1000W)



## Master-slave-control series operation procedure

- ① Check that the OUTPUT switch of each unit is turned off.
- ② Turn on the POWER switch of the master unit.
- ③ Turn on the POWER switch of each slave unit.
- ④ Turn the VOLTAGE control and the CURRENT control of each slave unit fully clockwise.

### NOTE

- Preset the output of each slave unit to the maximum level, so that it can follow the preset output of the master unit.
- ⑤ While presetting the LIMIT switch of the master unit, preset the output voltage and current.

### NOTE

- The total output voltage setup value can be found by multiplying the preset value of the master unit by the number of units used for the series operation.
- ⑥ Turn on the OUTPUT switch of the master unit.
  - ⑦ "CV" lights up on the master unit control panel, indicating that the unit is in constant voltage operation mode.
  - ⑧ Turn on the OUTPUT switch of each slave unit.
  - ⑨ "CV" lights up on the control panel of each slave unit, indicating that the unit is in constant voltage operation mode.
  - ⑩ The same output voltage and current displayed on the master unit are also displayed on each slave unit. This means that the total voltage of all the units is applied to the load.

# Chapter 4 Names and Functions of Controls

## 4.1 Front panel

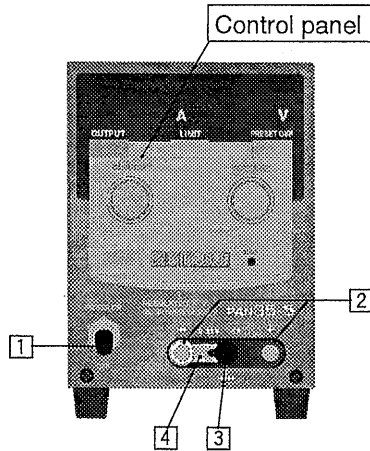

Fig. 4-1A Front panel of PAN series model 175W

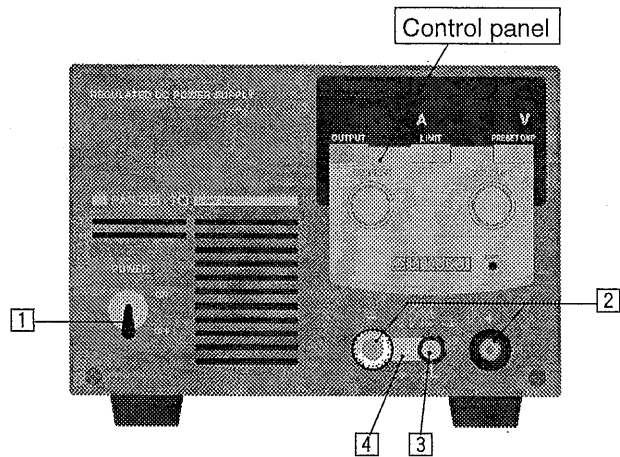

Fig. 4-1B Front panel of PAN series model 350W

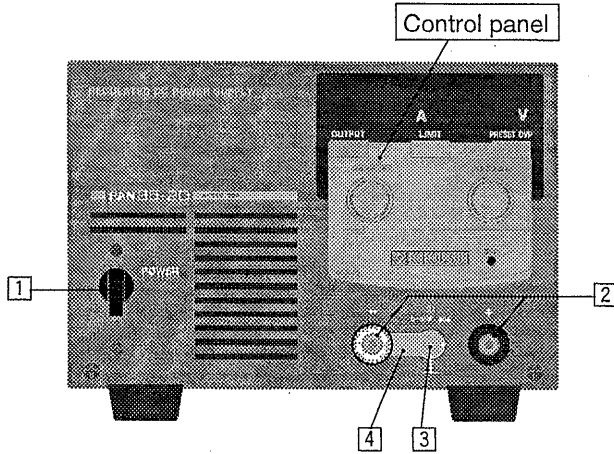

Fig. 4-1C Front panel of PAN series model 700W

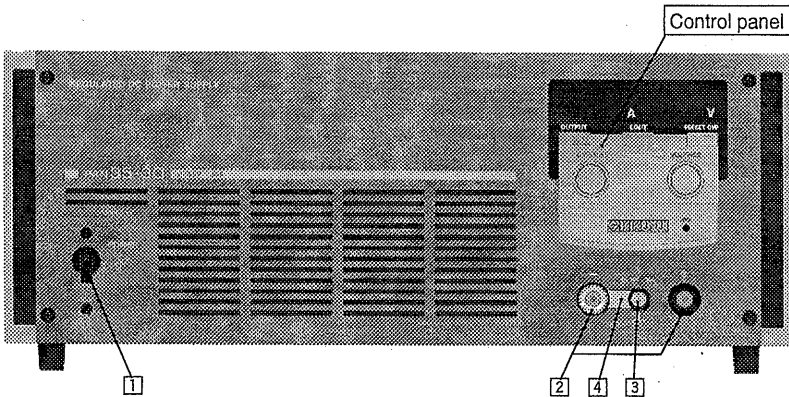

Fig. 4-1D Front panel of PAN series model 1000W

NOTE



- On the front panel of the PAN16-50, there is no [2] + and - (auxiliary output terminals), [3]  $\perp$  (chassis ground terminal), and [4] shorting bar for grounding chassis.

## 1 POWER

Turns the power of the unit on and off. Flip up the lever to turn the power ON, and flip it down to turn the power OFF.

## 2 +, - (auxiliary output terminals) ⚠

These terminals are designed for handy use in supplying output from the unit. Output from these terminals, however, may not satisfy the specifications of the unit.

### WARNING

- To avoid electric shock, always turn off the POWER switch whenever it is necessary to touch the terminals.

### NOTE



1000W  
PAN16-50

- The PAN16-50 has no auxiliary output terminals.

## 3 ⊥ (chassis ground terminal)

This terminal is connected to the chassis of the unit. This terminal and the auxiliary output + (pos.) or - (neg.) terminal should usually be connected using the shorting bar.

## 4 Shorting bar for grounding chassis

This is used to connect the auxiliary output + (pos.) or - (neg.) terminal to the chassis ground terminal (⊥).

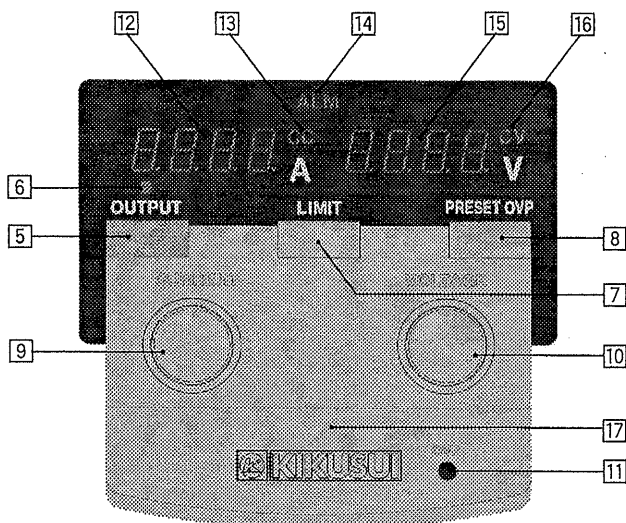

Fig. 4-2 PAN series control panel

#### 5 OUTPUT

Turns the output on and off. It is turned on at pushed.

When the output is turned off, the output circuit is set into a state of high impedance (several  $k\ \Omega$ ).

#### 6 OUTPUT ON indication

This LED lights up when the output is turned on.

#### 7 LIMIT

This is used to preset or check the output voltage limit and/or the output current limit. While pressing this switch, the currently preset voltage and current are displayed.

#### 8 PRESET OVP

This is used to preset or check the OVP (over-voltage protection) voltage. While this switch is held down, the currently preset OVP voltage is displayed.

#### 9 CURRENT

This is used to set output current for constant current operation mode. (10 turns)

## 10 VOLTAGE

This is used to set output voltage for constant voltage operation mode. (10 turns)

## 11 OVP

This is the OVP (over-voltage protection) control, and used to preset the trip point of the OVP circuit.

## 12 Ammeter

Indicates the output current when the OUTPUT switch is turned on. Indicates the output current limit when the LIMIT switch is pressed.

## 13 CC

"CC" (Constant Current) is displayed when the unit is in its constant current operation mode.

## 14 ALM

"ALM" (alarm) lights up when the OVP circuit trips.

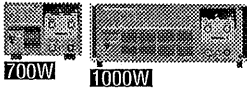

In the case of the models 700W and 1000W, the power switch is shut down as soon as the ALM lamp lights up, and all displays on the panel go off.

## NOTE

- The ALM lamp lights up if any one of the following protection circuits functions.  
Overvoltage protection circuit, overheat protection circuit, voltage detection circuit, overcurrent protection circuit

## 15 Voltmeter

Indicates output voltage when the OUTPUT switch is turned on. Indicates the output voltage limit when the LIMIT switch is pressed. Indicates the OVP trip voltage when the PRESET OVP switch is pressed.

## 16 CV

"CV" (Constant Voltage) is displayed when the unit is in its constant voltage operation mode.

### 17 Front sub-panel cover

This is used to cover the switches and variable resistors that are seldom used. To open it, press both sides of the cover and pull it forward. Beneath the cover are the remote control switches and variable resistors for calibration.

## 4.2 Rear panel

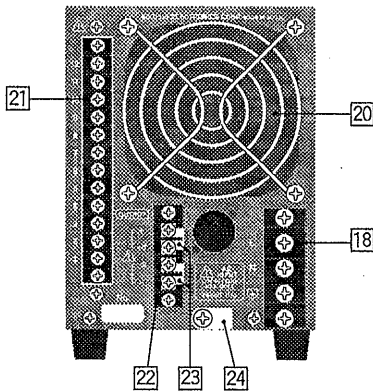

Fig. 4-3A Rear panel of PAN series model 175W

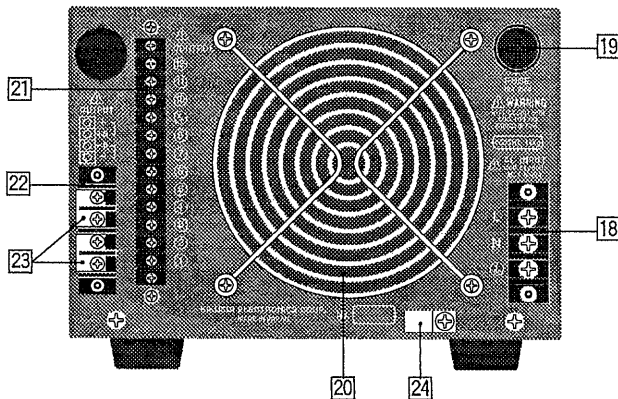

Fig. 4-3B Rear panel of PAN series models 350W and 700W

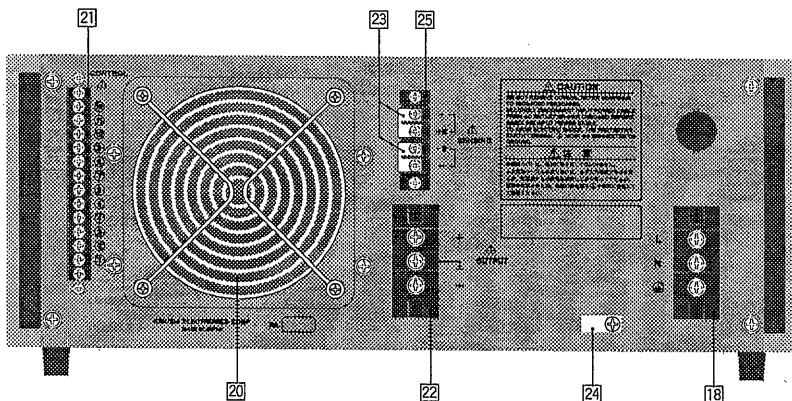

Fig. 4-3C Rear panel of PAN series model 1000W (excluding PAN16-50)

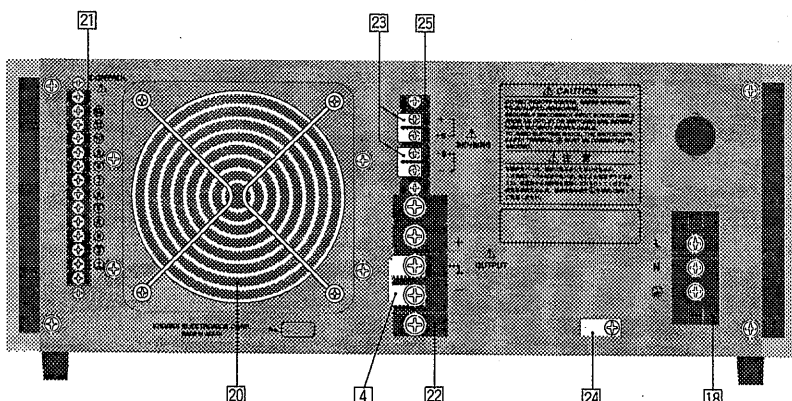

Fig. 4-3D Rear panel of PAN16-50

### 18 AC INPUT ⚠

AC input terminals. Connect the supplied AC power cable.

### WARNING

- Incorrect handling may cause electric shock. Always follow the instructions in section 1.5, "Connecting the AC power cable".
- Make sure that the ground terminal ⊕ is securely grounded. For details, see section 1.6, "Grounding".



## 19 FUSE ⚠

Fuse holder. A AC input fuse element is put in this.

### WARNING

- Incorrect handling may cause electric shock. Always follow the instructions in section 1.4, "Checking the input fuse".

### NOTE



- The input fuses of the models 175W and 1000W are located inside, and no fuse holder is found on the rear panel.

## 20 Exhaust port

This port uses a fan to exhaust heated air from inside. Keep sufficient space around the unit for good ventilation.

## 21 CONTROL ⚠

This is the terminal board used for applied operations such as remote control.

### WARNING

- Incorrect handling may cause electric shock. For details, see section 3.2, "Analog remote control".

## 22 OUTPUT ⚠

This is the output terminal board. The terminals +S and -S are used for sensing operations.

### WARNING

- To avoid electric shock, always turn off the POWER switch whenever it is necessary to touch the terminals.

## NOTE



- The sensing terminals of the model 1000W are located on the [25] SENSING terminal board.
- The ⊥ terminal is chassis ground terminal.

### [23] Shorting bar for sensing

When using the sensing function, remove this shorting bar.

### [24] Cable clamper

The cable clamper fastens the AC power cable to the rear panel, and protects the connected part from stress when the cable is pulled out.



### [25] SENSING ⚠

Used for sensing operations.

## WARNING

- To avoid electric shock, always turn off the POWER switch whenever it is necessary to touch the terminals.

To maintain the unit's original performance as long as possible, conduct periodic checks and maintenance.

### 5.1 Cleaning

When the panel gets soiled, wet a piece of soft cloth with a water-diluted neutral detergent, and wipe the panel softly.

The air intake port on the front panel is equipped with an air filter inside. Suck out any dust with a vacuum cleaner.

#### CAUTION

- For maintenance work, always turn off the POWER switch, and either disconnect the AC power cable or turn off the switch on the switchboard.
- Do not use volatile solvents such as thinner and benzene. They may discolor the unit surface coating, erase printed characters, or make face of display opaque.

### 5.2 Inspection

#### AC power cable

Check that there is no damage on the insulation coating, and that the plug is firmly attached and free from cracks.

#### WARNING

- Breaks in the insulation coating may cause electric shock. If a break is found, immediately stop using the unit.

To purchase accessories, contact your Kikusui agent.

## 5.3 Calibration

The unit is factory-calibrated based on control from the front panel (i.e., local control). To use remote control (excluding output ON/OFF using external contact points), however, re-calibration is necessary. Re-calibration is also necessary when changing from remote control back to local control.

This Operation Manual describes calibration only of the unit's remote-control function. In the course of long use of the unit, however, other items may also need calibration due to the effect of age. For all such calibrations, contact your Kikusui agent.

### 5.3.1 Test equipment required

For calibration, the following equipment is necessary.

- DC voltmeter (DVM) with measuring accuracy of 0.02% max.
- Shunt resistor with accuracy of 0.1% max.

### 5.3.2 Calibration procedure

Calibration items can be roughly classified into two areas: the voltage system and the current system. These items may change depending on what is to be controlled by remote control. It is not necessary, however, to calibrate remote control for the output ON/OFF.

If remote control is used for the output current by means of external voltage, calibration of the current system is necessary.

Calibration is conducted by using the adjusting variable resistors "2" and "4" - "8", located under the front panel cover.

#### CAUTION

- Never touch the variable resistors "1", "3", "9" and "10", as they are not involved in the user adjustment process. If you have moved any of them by mistake, re-adjustment is necessary. In such cases, contact your Kikusui agent.

#### ■ Warming-up

To minimize calibration error affected by initial drift, warm up the unit at least 30 minutes before starting calibration.

## Voltage system calibration procedure

The voltage system includes the following three items. Since all the items are related to one another, calibrate them all in the following sequence.

- Output voltage offset
- Output voltage in full scale
- Output voltage display in full scale

### ■ Connection of equipment

- ① Turn off the OUTPUT switch.
- ② Turn off the POWER switch.
- ③ Connect a DVM as shown in Fig. 5-1A.

#### NOTE



- For the model 1000W user, see Fig. 5-1B.

- ④ Connect the - (neg.) terminal and the chassis ground terminal ( $\perp$ ) with the shorting bar.

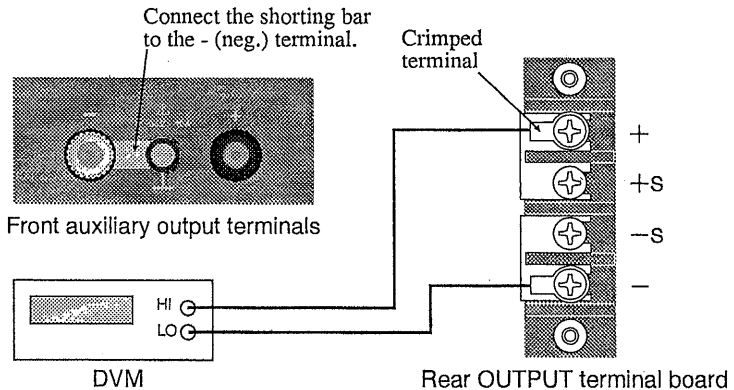

Fig. 5-1A Connection for voltage system calibration



1000W

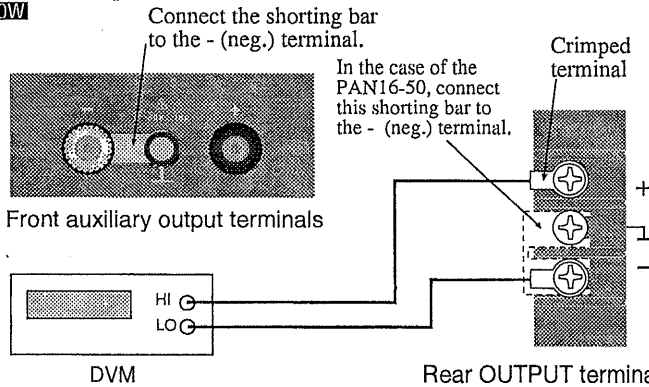

Fig. 5-1B Connection for voltage system calibration (model 1000W)

- ⑤ Turn on the POWER switch.
- Output voltage offset
  - ⑥ Set the output voltage to 0 V.  
For local control, turn the VOLTAGE control fully counter-clockwise. For remote control, set the control input to 0 V or 0  $\Omega$ .
  - ⑦ Turn on the OUTPUT switch.
  - ⑧ Turn the CURRENT control clockwise.
  - ⑨ Check that the unit is in the constant voltage operation mode, and perform an offset adjustment using variable resistor "2".

• Output voltage in full scale

- ⑩ Set the output voltage to the maximum.  
For local control, turn the VOLTAGE control fully clockwise. For remote control, set the control input to 10.5 V or 10 k  $\Omega$ .
- ⑪ Using variable resistor "4", adjust the output voltage to 105% of the rated output voltage.

CAUTION

- The maximum output voltage of the unit is specified at 105% of the rated output voltage. It is possible to adjust to a level higher than 105% using variable resistor "4", but this may damage the unit.

NOTE

- For remote control using external voltage, a 10 V control signal may be selected and adjusted to 100% of the rated output voltage of the unit.

• Output voltage display in full scale

- ⑫ With the rated voltage output, adjust variable resistor "5" so that the display of the unit shows the rated output voltage value.

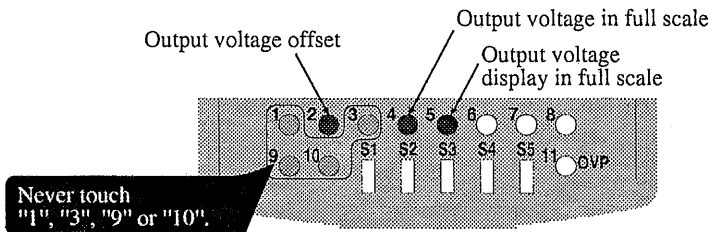

Front control panel

Fig. 5-2 Voltage system adjustment variable resistor

## Current system calibration procedure

The current system includes the following three items. Since all the items are related to one another, calibrate them all in the following sequence.

- Output current offset
- Output current in full scale
- Output current display in full scale

### ■ Connection of equipment

- ① Turn off the OUTPUT switch.
- ② Turn off the POWER switch.
- ③ Connect a shunt resistor and DVM as shown in Fig. 5-3A.

#### NOTE



- For the model 1000W user, see Fig. 5-3B.

- ④ Connect the - (neg.) terminal and the chassis ground terminal ( $\perp$ ) with the shorting bar.

#### CAUTION

- Use load cables of sufficient current capacity to cover the rated current.

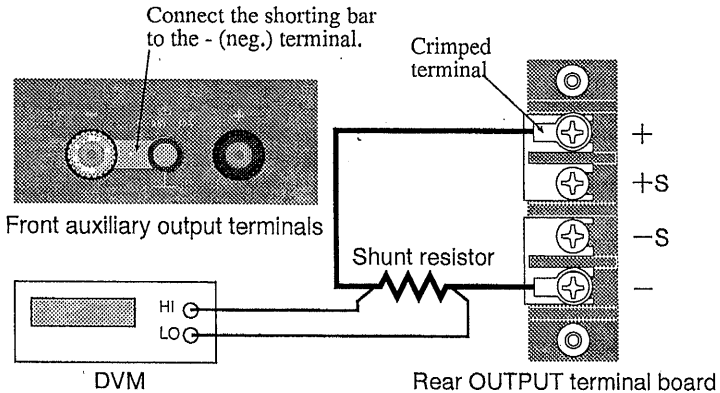

Fig. 5-3A Connection for current system calibration



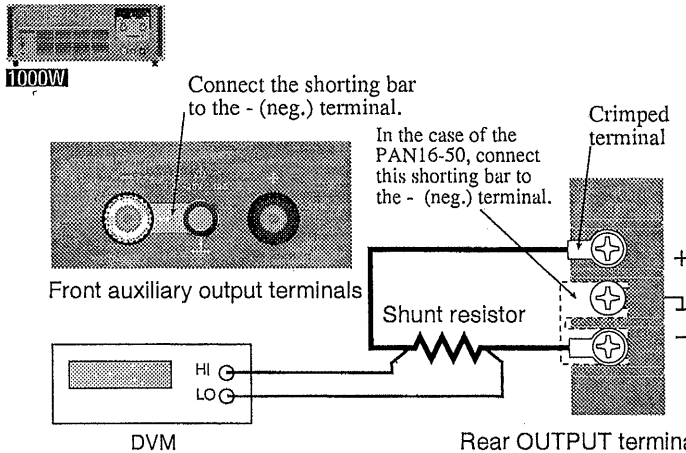

Fig. 5-3B Connection for current system calibration (model 1000W)

⑤ Turn on the POWER switch.

• Output current offset

⑥ Set the output current to 0 A.

For local control, turn the CURRENT control fully counter-clockwise. For analog remote control, set the control input to 0 V or 0  $\Omega$ .

⑦ Turn on the OUTPUT switch.

⑧ Turn the VOLTAGE control clockwise.

⑨ Check that the unit is in its constant current operation mode, and perform offset adjustment using variable resistor "6".

• Output current in full scale

⑩ Set the output current to the rated output current.

For local control, turn the CURRENT control fully clockwise. For analog remote control, set the control input to 10.5 V or 10 k  $\Omega$ .

⑪ Using variable resistor "7", adjust the output current to 105% of the rated output current.

CAUTION

- The maximum output current of the unit is specified as 105% of the rated output current. It is possible to

adjust to a level higher than 105% using variable resistor "7", but this may damage the unit.

————— NOTE —————

- For remote control using external voltage, a 10 V control signal may be selected and adjusted to 100% of the rated output current of the unit.
- Output current display in full scale
  - ⑪ With the rated current output, adjust variable resistor "8" so that the display of the unit shows the rated output current value.

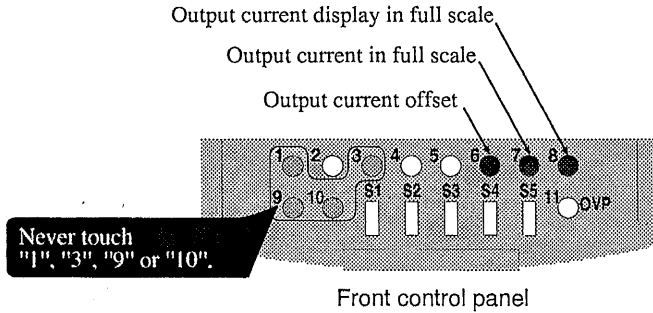

Fig. 5-4 Current system adjustment variable resistor

Unless otherwise specified, the specifications of the unit are based on the following conditions.

- The load is a pure resistance.
- The - (neg.) output terminal is connected to the chassis ground terminal ( $\perp$ ) with the supplied shorting bar.
- The unit should be used after 30 minutes warming-up time (with current flowing), at an ambient temperature of  $23^{\circ}\text{C} \pm 5^{\circ}\text{C}$ , with 80% RH max.
- TYP value, standard value and theoretical value do not guarantee performance. They should be referred to as target values only.

## Specifications of PAN Series Model 175W

Model 175W		PAN16-10	PAN35-5	PAN55-3	PAN70-2.5	PAN110-1.5	PAN160-1
Input voltage and frequency		100VAC±10%, 50/60Hz, 1-phase (110, 120, 200, 220, 240VAC input are factory option.*1)					
Power consumption, at 100VAC, rated load		Approx. 400VA	Approx. 400VA	Approx. 350VA	Approx. 350VA	Approx. 400VA	Approx. 330VA
Output							
Voltage	Rated voltage	16V	35V	55V	70V	110V	160V
	Variable range	0-16V	0-35V	0-55V	0-70V	0-110V	0-160V
	Resolution (theoretical value) *2	3mV	7mV	10mV	13mV	20mV	30mV
Number of turns of panel control		10 turns					
Current	Rated current	10A	5A	3A	2.5A	1.5A	1A
	Variable range	0-10A	0-5A	0-3A	0-2.5A	0-1.5A	0-1A
	Resolution (theoretical value) *2	1.8mA	0.9mA	0.6mA	0.5mA	0.3mA	0.2mA
Number of turns of panel control		10 turns					

\*1: For 240VAC input requirement, maximum input voltage is limited to 250VAC.

\*2: The value is calculated from the number of turns of the wire-wound potentiometer. In practice, use 3-5 times each value as a target.

Model 175W	PAN16-10	PAN35-5	PAN55-3	PAN70-2.5	PAN10-11.5	PAN160-1
<b>Constant voltage characteristics</b>						
Ripple and noise (5Hz-1MHz), RMS	500 $\mu$ V	500 $\mu$ V	500 $\mu$ V	500 $\mu$ V	500 $\mu$ V	1mV
Source effect (to $\pm 10\%$ of AC input voltage)	0.005%+1mV	0.005%+1mV	0.005%+1mV	0.005%+1mV	0.005%+1mV	0.005%+1mV
Load effect (to 0-100% of output current)	0.005%+1mV	0.005%+1mV	0.005%+1mV	0.005%+1mV	0.005%+1mV	0.005%+1mV
Transient response (standard value) *3	50 $\mu$ s	50 $\mu$ s	50 $\mu$ s	50 $\mu$ s	50 $\mu$ s	50 $\mu$ s
Temperature coefficient	100ppm/ $^{\circ}$ C (TYP value)					
<b>Constant current characteristics</b>						
Ripple and noise (5Hz-1MHz), RMS	2mA	1mA	1mA	1mA	1mA	1mA
Source effect (to $\pm 10\%$ of AC input voltage)	1mA	1mA	1mA	1mA	1mA	1mA
Load effect (to approx. 1 V-100% of output voltage)	3mA	2mA	2mA	1mA	1mA	1mA
Temperature coefficient	300ppm/ $^{\circ}$ C (TYP value)					
<b>Constant voltage operation indication</b>						
C.V, green LED indication						
<b>Constant current operation indication</b>						
C.C, red LED indication						
<b>Range of operation temperature and humidity</b>						
0-40 $^{\circ}$ C/10-90% RH (no dew condensation allowed)						
<b>Range of storage temperature and humidity</b>						
-10-60 $^{\circ}$ C/ 0-70% RH max. (no dew condensation allowed)						
<b>Cooling system</b>						
Forced air cooling with fan						
<b>Output polarity</b>						
Positive or negative grounding possible						
<b>Isolation</b>						
$\pm 250V$			$\pm 250V$		$\pm 250V$	$\pm 500V$

\*3: Time necessary for output voltage to return to 0.05%+10mV max. of rated value at 5%-100% changes of output current.

Model 175W		PAN16-10	PAN35-5	PAN55-3	PAN70-2.5	PAN110-1.5	PAN160-1
Insulation resistance							
Across chassis and input power source		500VDC, 30M $\Omega$ min. (measured at ambient humidity 70% RH max.)					
Across chassis and output terminals		500VDC, 20M $\Omega$ min. (measured at ambient humidity 70% RH max.)					
Withstanding voltage							
Across input and output terminals		Should withstand 1500VAC, 1 min. with no abnormalities					
Across input and chassis		Should withstand 1500VAC, 1 min. with no abnormalities					
Meter display							
Output voltage	Max. figure displayed (fixed range)	19.99	199.9	199.9	199.9	199.9	199.9
	Display error	$\pm(0.5\% \text{rdg} + 2 \text{digits})$ at 23°C $\pm 5^\circ\text{C}$					
	Temperature coefficient	300 ppm/ $^\circ\text{C}$ (TYP value)					
Output current	Max. figure displayed (fixed range)	19.99	19.99	19.99	19.99	1.999	1.999
	Display error	$\pm(1\% \text{rdg} + 5 \text{digits})$ at 23°C $\pm 5^\circ\text{C}$					
	Temperature coefficient	400 ppm/ $^\circ\text{C}$ (TYP value)					
Remote control							
Output voltage/control voltage ratio		16V/ approx. 10V	35V/ approx. 10V	55V/ approx. 10V	70V/ approx. 10V	110V/ approx. 10V	160V/ approx. 10V
Output voltage/control resistance ratio		16V/ approx. 10k $\Omega$	35V/ approx. 10k $\Omega$	55V/ approx. 10k $\Omega$	70V/ approx. 10k $\Omega$	110V/ approx. 10k $\Omega$	160V/ approx. 10k $\Omega$
Output current/control voltage ratio		10A/ approx. 10V	5A/ approx. 10V	3A/ approx. 10V	2.5A/ approx. 10V	1.5A/ approx. 10V	1A/ approx. 10V
Output current/control resistance ratio		10A/ approx. 10k $\Omega$	5A/ approx. 10k $\Omega$	3A/ approx. 10k $\Omega$	2.5A/ approx. 10k $\Omega$	1.5A/ approx. 10k $\Omega$	1A/ approx. 10k $\Omega$
Remote sensing		Possible (compensation one way approx. 0.6V max.)					
Master-slave-control parallel operation		Possible					
Master-slave-control series operation		Possible					

Model 175W	PAN16-10	PAN35-5	PAN55-3	PAN70-2.5	PAN110-1.5	PAN160-1
Protective circuit						
Over-voltage protection (OVP) for output	Preset range: Approx. 10-110% of rated output voltage, ALM LED lights up, control transistor cut off, and rectification circuit shut down when OVP tripped.					
Input fuse, 6.4mm dia. × 32mm	7A, 125VAC/250VAC					
Output fuse, 6.4mm dia. × 32mm, standard pre-arcing time-current type	10A	6A	3A	3A	2A	1A
Thermal fuse	130°C, incorporated in power transformer winding					
Weight	Approx. 1.1kg	Approx. 1.1kg	Approx. 1.1kg	Approx. 1.1kg	Approx. 1.1kg	Approx. 1.1kg
Dimensions	See outline drawing.					
Accessory						
Operation manual	1 copy					
Power cable	1 pc. (SVT3 × 18AWG, approx. 2m)					
Cable clasper	1 pc.					
Protection cover	AC input terminal cover 1 pc., Guard cap 2 pcs. Control terminal cover 1 pc., Rear output terminal cover 1 pc., Front auxiliary output terminal cover 1 pc., (Mounting screw(M3 × 20) 1 pc.)					

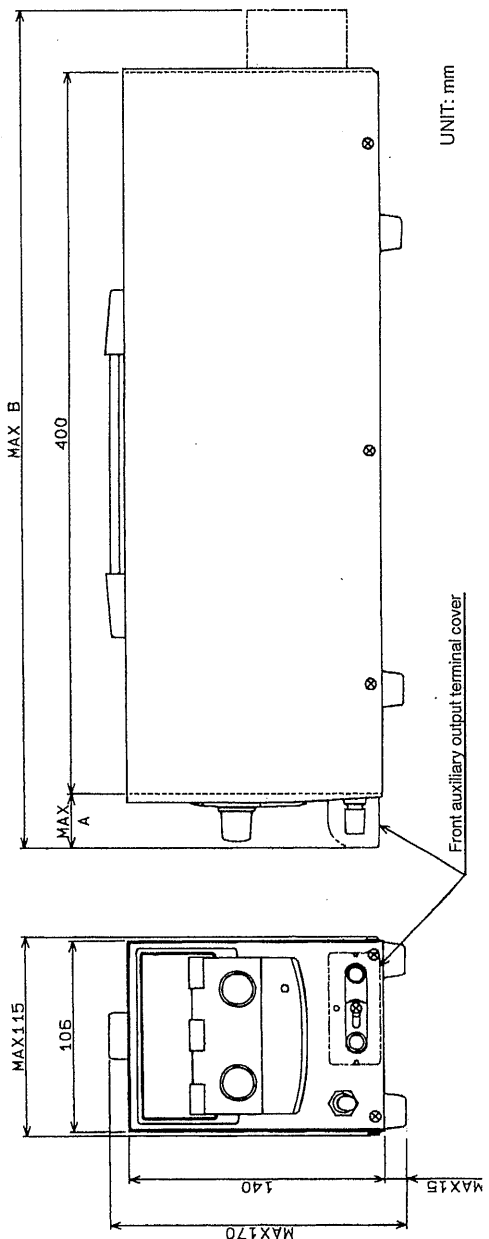

UNIT: mm

Front auxiliary output terminal cover

Model	MAX A	MAX B	Front auxiliary output terminal cover
PAN16-10	30	455	Not provided
PAN35-5			
PAN55-3			
PAN70-2.5	35	460	Provided
PAN110-1.5			
PAN160-1			

PAN Series Model 175W Outline Drawing



## Specifications of PAN Series Model 350W

Model 350W		PAN16-18	PAN35-10	PAN55-6	PAN70-5	PAN110-3	PAN160-2
<b>Input</b>							
Input voltage and frequency		100VAC±10%, 50/60Hz, 1-phase (110, 120, 200, 220, 240VAC input are factory option.*1)					
Power consumption, at 100VAC, rated load		Approx. 800VA	Approx. 800VA	Approx. 700VA	Approx. 800VA	Approx. 700VA	Approx. 700VA
<b>Output</b>							
Voltage	Rated voltage	16V	35V	55V	70V	110V	160V
	Variable range	0-16V	0-35V	0-55V	0-70V	0-110V	0-160V
	Resolution (theoretical value) *2	3mV	7mV	10mV	13mV	20mV	30mV
	Number of turns of panel control	10 turns					
Current	Rated current	18A	10A	6A	5A	3A	2A
	Variable range	0-18A	0-10A	0-6A	0-5A	0-3A	0-2A
	Resolution (theoretical value) *2	3.3mA	1.8mA	1.1mA	0.9mA	0.6mA	0.4mA
	Number of turns of panel control	10 turns					

\*1: For 240VAC input requirement, maximum input voltage is limited to 250VAC.

\*2: The value is calculated from the number of turns of the wire-wound potentiometer. In practice, use 3-5 times each value as a target.

Model 350W	PAN16-18	PAN35-10	PAN55-6	PAN70-5	PAN10-3	PAN160-2
Constant voltage characteristics						
Ripple and noise (5Hz-1MHz) RMS	500 $\mu$ V	500 $\mu$ V	500 $\mu$ V	500 $\mu$ V	500 $\mu$ V	1mV
Source effect (to $\pm$ 10% of AC input voltage)	0.005%+1mV	0.005%+1mV	0.005%+1mV	0.005%+1mV	0.005%+1mV	0.005%+1mV
Load effect (to 0-100% of output current)	0.005%+1mV	0.005%+1mV	0.005%+1mV	0.005%+1mV	0.005%+1mV	0.005%+1mV
Transient response (standard value) *3	50 $\mu$ s	50 $\mu$ s	50 $\mu$ s	50 $\mu$ s	50 $\mu$ s	50 $\mu$ s
Temperature coefficient	100ppm/ $^{\circ}$ C (TYP value)					
Constant current characteristics						
Ripple and noise (5Hz-1MHz) RMS	5mA	2mA	2mA	2mA	1mA	1mA
Source effect (to $\pm$ 10% of AC input voltage)	1mA	1mA	1mA	1mA	1mA	1mA
Load effect (to approx. 1 V-100% of output voltage)	3mA	3mA	3mA	2mA	2mA	2mA
Temperature coefficient	300ppm/ $^{\circ}$ C (TYP value)					
Constant voltage operation indication	C.V, green LED indication					
Constant current operation indication	C.C, red LED indication					
Range of operation temperature and humidity	0-40 $^{\circ}$ C/10-90% RH (no dew condensation allowed)					
Range of storage temperature and humidity	-10-60 $^{\circ}$ C/0-70% RH max. (no dew condensation allowed)					
Cooling system	Forced air cooling with fan					
Output polarity	Positive or negative grounding possible					
Isolation	$\pm$ 250V	$\pm$ 250V	$\pm$ 250V	$\pm$ 250V	$\pm$ 250V	$\pm$ 500V

\*3: Time necessary for output voltage to return to 0.05%+10mV max. of rated value at 5%-100% changes of output current.

Model 350W		PAN16-18	PAN35-10	PAN55-6	PAN70-5	PAN110-3	PAN160-2
Insulation resistance							
Across chassis and input power source		500VDC, 30M $\Omega$ min. (measured at ambient humidity 70% RH max.)					
Across chassis and output terminals		500VDC, 20M $\Omega$ min. (measured at ambient humidity 70% RH max.)					
Withstanding voltage							
Across input and output terminals		Should withstand 1500VAC, 1 min. with no abnormalities					
Across input and chassis							
Meter display							
Output voltage	Max. figure displayed (fixed range)	19.99	199.9	199.9	199.9	199.9	199.9
	Display error	$\pm(0.5\%rdg+2digits)$ at 23 $^{\circ}$ C $\pm 5^{\circ}$ C					
Temperature coefficient		300 ppm/ $^{\circ}$ C (TYP value)					
Output current	Max. figure displayed (fixed range)	19.99	19.99	19.99	19.99	19.99	19.99
	Display error	$\pm(1\%rdg+5digits)$ at 23 $^{\circ}$ C $\pm 5^{\circ}$ C					
Temperature coefficient		400ppm/ $^{\circ}$ C (TYP value)					
Remote control							
Output voltage/control voltage ratio		16V/ approx. 10V	35V/ approx.10V	55V/ approx.10V	70V/ approx.10V	110V/ approx.10V	160V/ approx.10V
Output voltage/control resistance ratio		16V/ approx.10k $\Omega$	35V/ approx.10k $\Omega$	55V/ approx.10k $\Omega$	70V/ approx.10k $\Omega$	110V/ approx.10k $\Omega$	160V/ approx.10k $\Omega$
Output current/control voltage ratio		18A/ approx.10V	10A/ approx.10V	6A/ approx.10V	5A/ approx.10V	3A/ approx.10V	2A/ approx.10V
Output current/control resistance ratio		18A/ approx.10k $\Omega$	10A/ approx.10k $\Omega$	6A/ approx.10k $\Omega$	5A/ approx.10k $\Omega$	3A/ approx.10k $\Omega$	2A/ approx.10k $\Omega$
Remote sensing		Possible (compensation one way approx. 0.6V max.)					
Master-slave-control parallel operation		Possible					
Master-slave-control series operation		Possible					

Model 350W		PAN16-1B	PAN35-10	PAN55-6	PAN70-5	PAN110-3	PAN160-2
Protective circuit							
Over-voltage protection (OVP) for output		Preset range: Approx. 10-110% of rated output voltage, ALM LED lights up, control transistor cut off, and rectification circuit shut down when OVP tripped.					
Input fuse, 6.4mm dia. × 32mm		10A, 125VAC/250VAC					
Output fuse, 6.4mm dia. × 32mm, standard pre-arcing time-current type		20A	10A	6A	6A	3A	2A
Thermal fuse		130°C, incorporated in power transformer winding					
Weight		Approx. 16kg	Approx. 16kg	Approx. 16kg	Approx. 16kg	Approx. 16kg	Approx. 16kg
Dimensions		See outline drawing.					
Accessory							
Operation manual		1 copy					
Power cable		1 pc. (SVT3 × 18AWG, approx. 2m)					
Cable clammer		1 pc.					
Input fuse		1 pc.					
Protection cover		AC input terminal cover 1 pc., Guard cap 2 pcs.					
Rear output terminal cover 1 pc.		Control terminal cover 1 pc., Rear output terminal cover 1 pc., Front auxiliary output terminal cover 1 pc., (Mounting screw(M3 × 20) 1 pc.)					

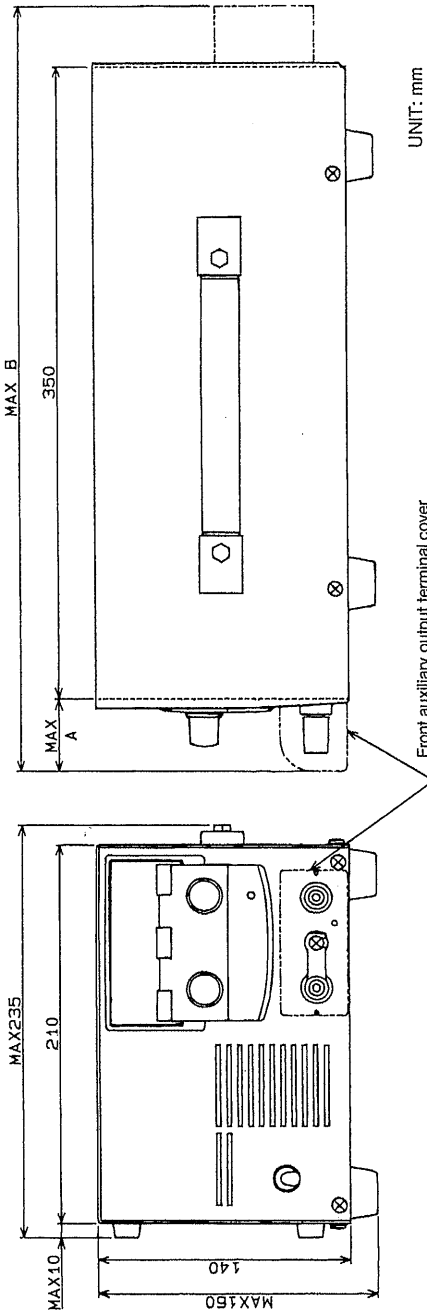

UNIT: mm

Front auxiliary output terminal cover

Model	MAX A	MAX B	Front auxiliary output terminal cover
PAN16-18	35	425	Not provided
PAN35-10	35	410	
PAN55-6	45	420	Provided
PAN70-5			
PAN110-3			
PAN160-2			

PAN Series Model 350W Outline Drawing

## Specifications of PAN Series Model 700W

Model 700W		PAN16-30	PAN35-20	PAN55-10	PAN70-8	PAN110-5	PAN160-3.5	PAN230-2.5
Input								
Input voltage and frequency		100VAC ± 10%, 50/60Hz, 1-phase (110, 120, 200, 220, 240VAC input are factory option. *1)						
Power consumption, at 100VAC, rated load		Approx. 1100VA	Approx. 1400VA	Approx. 1000VA	Approx. 1100VA	Approx. 1000VA	Approx. 1000VA	Approx. 1100VA
Output								
Voltage	Rated voltage	16V	35V	55V	70V	110V	160V	250V
	Variable range	0-16V	0-35V	0-55V	0-70V	0-110V	0-160V	0-250V
	Resolution (theoretical value) *2	3mV	7mV	10mV	13mV	20mV	30mV	45mV
	Number of turns of panel control	10 turns						
Current	Rated current	30A	20A	10A	8A	5A	3.5A	2.5A
	Variable range	0-30A	0-20A	0-10A	0-8A	0-5A	0-3.5A	0-2.5A
	Resolution (theoretical value) *2	5.4mA	3.6mA	1.8mA	1.5mA	0.9mA	0.7mA	0.5mA
	Number of turns of panel control	10 turns						

\*1: For 240VAC input requirement, maximum input voltage is limited to 250VAC.

\*2: The value is calculated from the number of turns of the wire-wound potentiometer. In practice, use 3-5 times each value as a target.

Model 700W	PAN16-30	PAN35-20	PAN55-10	PAN70-8	PAN110-5	PAN160-3.5	PAN250-2.5
Constant voltage characteristics							
Ripple and noise (5Hz-1MHz) RMS	500 $\mu$ V	500 $\mu$ V	500 $\mu$ V	1mV	1mV	1mV	5mV
Source effect (to $\pm 10\%$ of AC input voltage)	0.005%+1mV	0.005%+1mV	0.005%+1mV	0.005%+1mV	0.005%+1mV	0.005%+1mV	0.005%+2mV
Load effect (to 0-100% of output current)	0.005%+2mV	0.005%+2mV	0.005%+2mV	0.005%+1mV	0.005%+1mV	0.005%+2mV	0.005%+3mV
Transient response (standard value) *3	50 $\mu$ s	50 $\mu$ s	50 $\mu$ s	50 $\mu$ s	50 $\mu$ s	50 $\mu$ s	50 $\mu$ s
Temperature coefficient	100ppm/ $^{\circ}$ C (TYP値)						
Constant current characteristics							
Ripple and noise (5Hz-1MHz) RMS	5mA	3mA	3mA	2mA	1mA	1mA	2mA
Source effect (to $\pm 10\%$ of AC input voltage)	3mA	3mA	3mA	1mA	1mA	1mA	1mA
Load effect (to approx. 1 V-100% of output voltage)	3mA	3mA	3mA	3mA	2mA	2mA	1mA
Temperature coefficient	300ppm/ $^{\circ}$ C (TYP value)						
Constant voltage operation indication	C.V, green LED indication						
Constant current operation indication	C.C, red LED indication						
Range of operation temperature and humidity	0-40 $^{\circ}$ C/10-90% RH (no dew condensation allowed)						
Range of storage temperature and humidity	-10-60 $^{\circ}$ C/ 0-70% RH max. (no dew condensation allowed)						
Cooling system	Forced air cooling with fan						
Output polarity	Positive or negative grounding possible						
Isolation	$\pm 250$ V	$\pm 250$ V	$\pm 250$ V	$\pm 250$ V	$\pm 250$ V	$\pm 500$ V	$\pm 500$ V

\*3: Time necessary for output voltage to return to 0.05%+10mV max. of rated value at 5%-100% changes of output current.

Model 700W		PAN16-30	PAN36-20	PAN55-10	PAN70-8	PAN110-5	PAN160-3.5	PAN250-2.5
Insulation resistance								
Across chassis and input power source		500VDC, 30M $\Omega$ min. (measured at ambient humidity 70% RH max.)						
Across chassis and output terminals		500VDC, 20M $\Omega$ min. (measured at ambient humidity 70% RH max.)						
Withstanding voltage								
Across input and output terminals		Should withstand 1500VAC, 1 min. with no abnormalities						
Across input and chassis								
Meter display								
Output voltage	Max. figure displayed (fixed range)	19.99	199.9	199.9	199.9	199.9	199.9	1999
	Display error	$\pm (0.5\%rdg+2digits)$ at 23°C $\pm 5^\circ\text{C}$						
Temperature coefficient		300 ppm/ $^\circ\text{C}$ (TYP value)						
Output current	Max. figure displayed (fixed range)	199.9	199.9	19.99	19.99	19.99	19.99	19.99
	Display error	$\pm (1\%rdg+5digits)$ at 23°C $\pm 5^\circ\text{C}$						
Temperature coefficient		400ppm/ $^\circ\text{C}$ (TYP value)						
Remote control								
Output voltage/control voltage ratio		16V/ approx. 10V	35V/ approx. 10V	55V/ approx. 10V	70V/ approx. 10V	110V/ approx. 10V	160V/ approx. 10V	250V/ approx. 10V
Output voltage/control resistance ratio		16V/ approx. 10k $\Omega$	35V/ approx. 10k $\Omega$	55V/ approx. 10k $\Omega$	70V/ approx. 10k $\Omega$	110V/ approx. 10k $\Omega$	160V/ approx. 10k $\Omega$	250V/ approx. 10k $\Omega$
Output current/control voltage ratio		30A/ approx. 10V	20A/ approx. 10V	10A/ approx. 10V	8A/ approx. 10V	5A/ approx. 10V	3.5A/ approx. 10V	2.5A/ approx. 10V
Output current/control resistance ratio		30A/ approx. 10k $\Omega$	20A/ approx. 10k $\Omega$	10A/ approx. 10k $\Omega$	8A/ approx. 10k $\Omega$	5A/ approx. 10k $\Omega$	3.5A/ approx. 10k $\Omega$	2.5A/ approx. 10k $\Omega$
Remote sensing		Possible (compensation one way approx. 0.6V max.)						
Master-slave-control parallel operation		Possible						
Master-slave-control series operation		Possible						



Model 700W		PAN16-30	PAN35-20	PAN55-10	PAN70-8	PAN110-5	PAN160-3.5	PAN250-2.5
Protective circuit								
Over-voltage protection (OVP) for output		Preset range: Approx. 10-110% of rated output voltage, ALM LED lights up, control transistor cut off, and rectification circuit and circuit breaker shut down when OVP tripped.						
Input fuse, 6.4mm dia. X 32mm		15A, 125VAC /250VAC 20A, 125VAC /250VAC 30A						
Output fuse, 6.4mm dia. X 32mm, standard pre-arcing time-current type		15A, 125VAC/250VAC						
Thermal fuse		135°C, incorporated in power transformer winding						
Weight		Approx.23kg	Approx.23kg	Approx.22kg	Approx.22kg	Approx.22kg	Approx.22kg	Approx.22kg
Dimensions		See outline drawing.						
Accessory								
Operation manual		1 copy						
Power cable		1 pc. (Nominal cross section 3.5 mm <sup>2</sup> , cabtyre cable, no plug, approx. 3m)						
Cable clamper		1 pc.						
Input fuse		1 pc.						
Protection cover		AC input terminal cover 1 pc., Rear output terminal cover 1 pc., Guard cap 2 pcs.						
		Control terminal cover 1 pc., Front auxiliary output terminal cover 1 pc. (Mounting screw(M3×20) 1 pc.)						

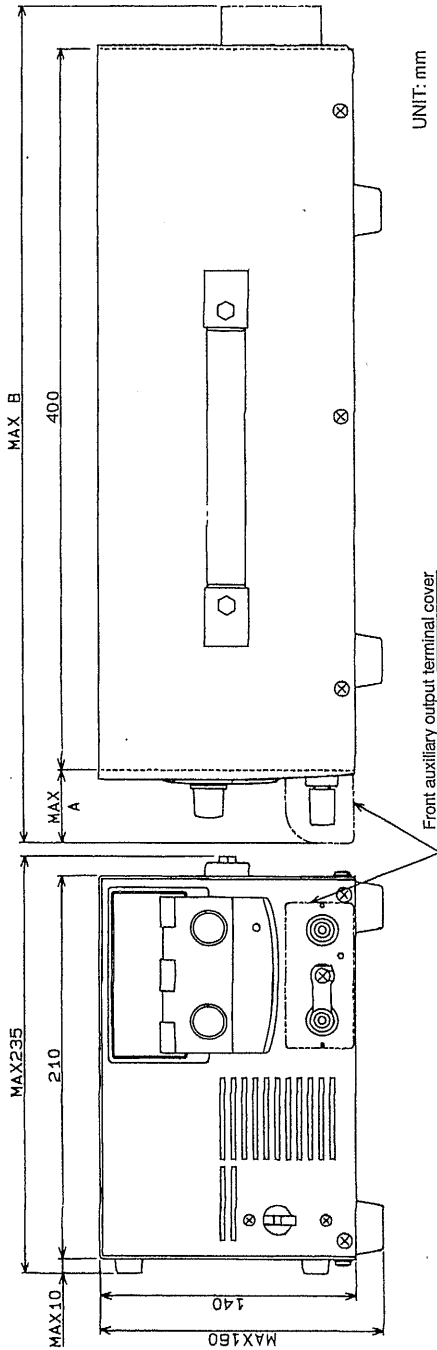

Model	MAX A	MAX B	Front auxiliary output terminal cover
PAN16-30	35	475	Not provided
PAN35-20			
PAN55-10			
PAN70-8			
PAN110-5	45	470	Provided
PAN160-3.5			
PAN250-2.5			

PAN Series Model 700W Outline Drawing

## Specifications of PAN Series Model 1000W

Model 1000W		PAN16-50	PAN35-30	PAN55-20	PAN70-15	PAN10-10	PAN160-7	PAN250-4.5
Input voltage and frequency		100VAC ± 10%, 50/60Hz, 1-phase (110, 120, 200, 220, 240VAC input are factory option. *1)						
Power consumption, at 100VAC, rated load		Approx. 1600VA	Approx. 1800VA	Approx. 1900VA	Approx. 1900VA	Approx. 2000VA	Approx. 1900VA	Approx. 1800VA
Output		10 turns						
Voltage	Rated voltage	16V	35V	55V	70V	110V	160V	250V
	Variable range	0-16V	0-35V	0-55V	0-70V	0-110V	0-160V	0-250V
	Resolution (theoretical value) *2	3mV	7mV	10mV	13mV	20mV	30mV	45mV
Number of turns of panel control		10 turns						
Current	Rated current	50A	30A	20A	15A	10A	7A	4.5A
	Variable range	0-50A	0-30A	0-20A	0-15A	0-10A	0-7A	0-4.5A
	Resolution (theoretical value) *2	9mA	5.4mA	3.6mA	2.7mA	1.8mA	1.3mA	0.9mA
Number of turns of panel control		10 turns						

\*1: For 240VAC input requirement, maximum input voltage is limited to 250VAC.

\*2: The value is calculated from the number of turns of the wire-wound potentiometer. In practice, use 3-5 times each value as a target.

Model 1000W	PAN16-50	PAN35-30	PAN55-20	PAN70-15	PAN110-10	PAN160-7	PAN250-4.5
Constant voltage characteristics							
Ripple and noise (5Hz-1MHz) RMS	500 $\mu$ V	500 $\mu$ V	500 $\mu$ V	1mV	1mV	1mV	5mV
Source effect (to $\pm 10\%$ of AC input voltage)	0.005%+1mV	0.005%+1mV	0.005%+1mV	0.005%+1mV	0.005%+1mV	0.005%+1mV	0.005%+2mV
Load effect (to 0-100% of output current)	0.005%+2mV	0.005%+1mV	0.005%+1mV	0.005%+1mV	0.005%+1mV	0.005%+2mV	0.005%+3mV
Transient response (standard value) *3	50 $\mu$ s	50 $\mu$ s	50 $\mu$ s	50 $\mu$ s	50 $\mu$ s	50 $\mu$ s	50 $\mu$ s
Temperature coefficient	100ppm/ $^{\circ}$ C (TYP value)						
Constant current characteristics							
Ripple and noise (5Hz-1MHz) RMS	10mA	5mA	2mA	5mA	2mA	2mA	2mA
Source effect (to $\pm 10\%$ of AC input voltage)	3mA	3mA	1mA	1mA	1mA	1mA	1mA
Load effect (to approx. 1 V-100% of output voltage)	5mA	5mA	2mA	3mA	3mA	2mA	2mA
Temperature coefficient	300ppm/ $^{\circ}$ C (TYP value)						
Constant voltage operation indication	C.V, green LED indication						
Constant current operation indication	C.C, red LED indication						
Range of operation temperature and humidity	0-40 $^{\circ}$ C/10-90% RH (no dew condensation allowed)						
Range of storage temperature and humidity	-10-60 $^{\circ}$ C / 0-70% RH max. (no dew condensation allowed)						
Cooling system	Forced air cooling with fan						
Output polarity	Positive or negative grounding possible						
Isolation	$\pm 250V$	$\pm 250V$	$\pm 250V$	$\pm 250V$	$\pm 250V$	$\pm 500V$	$\pm 500V$

\*3: Time necessary for output voltage to return to 0.05%+10mV max. of rated value at 5%-100% changes of output current.

Model	1000W	PAN16-50	PAN35-30	PAN55-20	PAN70-15	PAN110-10	PAN160-7	PAN250-4.5
Insulation resistance								
Across chassis and input power source								
500VDC, 30MΩ min. (measured at ambient humidity 70% RH max.)								
Across chassis and output terminals								
500VDC, 20MΩ min. (measured at ambient humidity 70% RH max.)								
Withstanding voltage								
Across input and output terminals								
Should withstand 1500VAC, 1 min. with no abnormalities								
Across input and chassis								
Meter display								
Output voltage								
Max. figure displayed (fixed range)								
19.99      199.9      199.9      199.9      199.9      199.9      199.9      199.9								
Display error								
±(0.5%rdg+2digits) at 23°C ±5°C								
Temperature coefficient								
300 ppm/°C (TYP value)								
Output current								
Max. figure displayed (fixed range)								
199.9      199.9      199.9      19.99      19.99      19.99      19.99      19.99								
Display error								
±(1%rdg+5digits) at 23°C ±5°C								
Temperature coefficient								
400ppm/°C (TYP value)								
Remote control								
Output voltage/control voltage ratio								
16V/ approx. 10V      35V/ approx.10V      55V/ approx.10V      70V/ approx.10V      110V/ approx.10V      160V/ approx.10V      250V/ approx.10V								
Output voltage/control resistance ratio								
16V/ approx.10kΩ      35V/ approx.10kΩ      55V/ approx.10kΩ      70V/ approx.10kΩ      110V/ approx.10kΩ      160V/ approx.10kΩ      250V/ approx.10kΩ								
Output current/control voltage ratio								
50A/ approx.10V      30A/ approx.10V      20A/ approx.10V      15A/ approx.10V      10A/ approx.10V      7A/ approx.10V      4.5A/ approx.10V								
Output current/control resistance ratio								
50A/ approx.10kΩ      30A/ approx.10kΩ      20A/ approx.10kΩ      15A/ approx.10kΩ      10A/ approx.10kΩ      7A/ approx.10kΩ      4.5A/ approx.10kΩ								
Remote sensing								
Possible (compensation one way approx. 0.6V max.)								
Master-slave-control parallel operation								
Possible								
Master-slave-control series operation								
Possible								

Model: 1000W	PAN16-50	PAN35-30	PAN55-20	PAN70-15	PAN110-10	PAN160-7	PAN250-4.5
Protective circuit							
Over-voltage protection (OVP) for output	Preset range: Approx. 10-110% of rated output voltage, ALM LED lights up, control transistor cut off, and rectification circuit and circuit breaker shut down when OVP tripped.						
Input fuse, 15mm dia. X 40mm	30A, 125VAC/250VAC						
Output fuse, 6.4mm dia. X 32mm, standard pre-arcing time-current type	50A *4	30A	20A	15A	10A	10A	6A
Thermal fuse	135°C, incorporated in power transformer winding						
Weight	Approx.36kg	Approx.36kg	Approx.35kg	Approx.35kg	Approx.35kg	Approx.36kg	Approx.35kg
Dimensions	See outline drawing.						
Accessory							
Operation manual	1 copy						
Power cable	1 pc. (Nominal cross section 3.5 mm <sup>2</sup> , cable type, no plug, approx. 3m)						
Cable clamp	1 pc.						
Protection cover	AC input terminal cover 1 pc., Rear output terminal cover 1 pc., Guard cap 2 pcs.						
	Control terminal cover 1 pc., Sensing terminal cover 1 pc. Front auxiliary output terminal cover 1 pc. (Mounting screw(M3×20) 1 pc.)						

\*4: 20mm dia. X 60mm

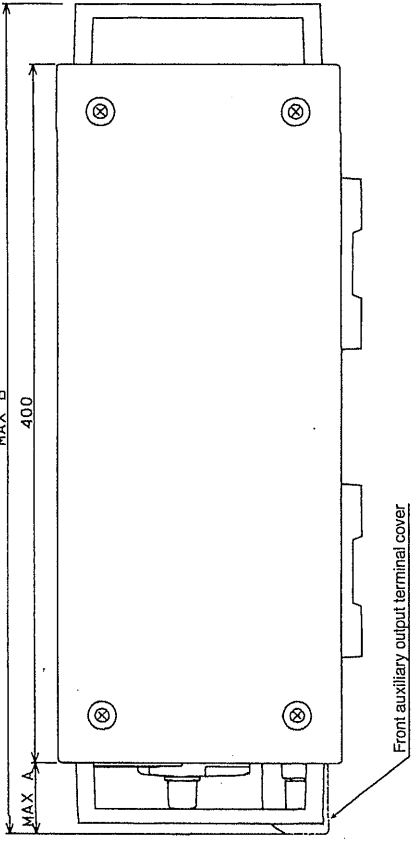
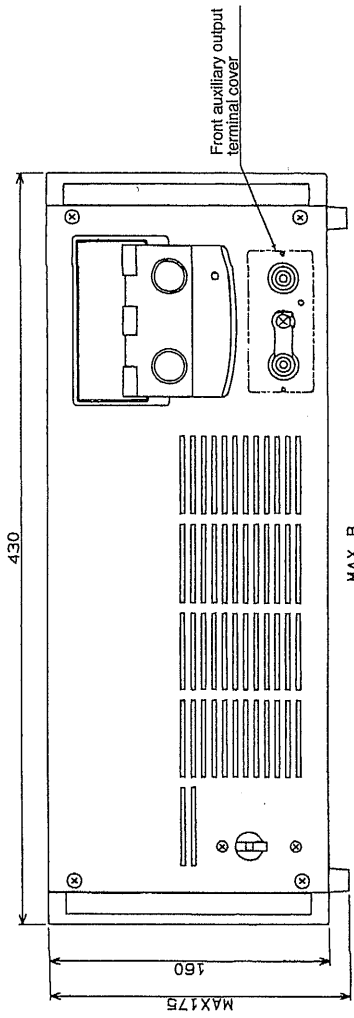

Model	MAX A	MAX B	Front auxiliary output terminal cover
PAN16-50*	40	480	Not provided
PAN35-30			
PAN55-20			
PAN70-15	45	485	Provided
PAN110-10			
PAN160-7			
PAN250-4.5			

\*No front auxiliary output terminals

PAN Series Model 1000W Outline Drawing

**KIKUSUI ELECTRONICS CORP.**

1-1-3, Higashiyamata, Tsuzuki-ku, Yokohama, 224-0023, Japan

Tel : 045-593-7570 Fax : 045-593-7571



**Kikusui Electronics Corporation**



\* 2 1 0 0 1 6 1 2 \*