

# Setup Guide

## PCR-LE Series Three-phase Output Driver 3P05-PCR-LE(500HZ LMT)

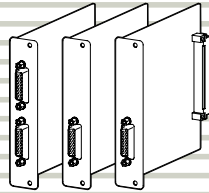

Thank you for purchasing the PCR-LE Series Three-phase output driver.

Connecting the outputs of PCR-LE Series in star connection and installing the Three-phase Output Driver in these power supplies allows them to be used as three-phase system power supplies.

The 3P05-PCR-LE(500HZ LMT) limits the maximum output frequency of PCR-LE series to 500 Hz.

### KIKUSUI ELECTRONICS CORP.

1-1-3, Higashiyamata, Tsuzuki-ku, Yokohama, 224-0023, Japan  
TEL: +81-45-593-7570 Fax: +81-45-593-7571

WEBSITE <http://www.kikusui.co.jp/en>



PCR-LE Manual

## Features

Use of this device allows the PCR-LE series to provide the following enhanced functions, in addition to the PCR-LE's standard functions.

- Three-phase Output  
Use of the device allows the three PCR-LE to generate three-phase output, in which the U-phase unit of the three power supplies acts as a master and their V and W phase units acts as slaves.
- Setting of Either the Line Voltage or Phase Voltage
- Independent Phase Voltage Setting  
The individual phase voltage setting is possible on a phase basis.
- Line Voltage Measurement
- Measurements of the Total Power, Total Apparent Power, and Total Power Factor of Three Phases  
Use of the device allows the totals of power and apparent power obtained through measurement using the three PCR-LE to be displayed. The total power factor of the three phases can also be calculated from these total values.
- Variable Phase Difference

The newest version of the operation manual can be downloaded from Download service of Kikusui website.

The contents of this manual may not be reproduced, in whole or in part, without the prior consent of the copyright holder.

The specifications of this product and the contents of this manual are subject to change without prior notice.

© 2012

## Check at Unpacking

Upon reception of the product, confirm that the package contains the necessary accessories and that the device and accessories have not been damaged during transportation. If the device is damaged or any accessory is missing, notify Kikusui distributor/agent.

The indications "V" and "W" on the panel part of each board.

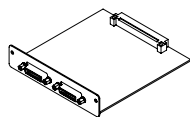

U phase boards  
(1 pc.)

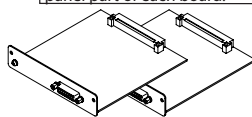

V and W phase boards  
(one each)

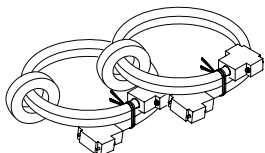

Connecting cable (75 cm; 2 pcs.)  
Cable: [91-80-9919]  
Core: [96-00-0530]

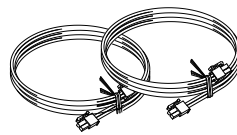

Power-sync cable  
(1 m; 2 pcs.)  
[91-80-5099]

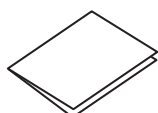

Setup Guide  
(This guide)(1 pc.)

## Firmware version of PCR-LE

When using the 3P05-PCR-LE, the PCR-LE must be required with the firmware version of 2.00 or later. If the firmware version of the PCR-LE is 1.99 or previous version, the PCR-LE is required for the firmware update.

When using the 3P05-PCR-LE, the firmware of all the PCR-LE series that make up the system must be the same.

To check the firmware version of the PCR-LE, refer to the operation manual of the PCR-LE series. In case, the PCR-LE needs update, contact your Kikusui agent or distributor.

## Functional Restrictions during Three-phase Operation

Use of the 3P05-PCR-LE allows the PCR-LE series to generate three-phase outputs. The following functions are not available when the device is installed in the power supplies.

- DC mode
- Regulation adjustment
- High-speed response

You cannot use the 3P05-PCR-LE with the 2P05-PCR-LE Single-Phase Three-Wire Output Driver Option.

## Handling Precautions

### ■ Handling of the U, V, and W phase Boards

- Ground yourself by touching a grounded metal object before touching the board.
- Avoid handling the interface board in an environment subject to strong static electricity.
- For storage, provide electrostatic protection measures such as the anti-static bag accompanying the interface board.
- Do not drop a board or subject it to other impact.
- Do not install or uninstall the interface board with the power ON of the PCR-LE Series.

### ■ Handling of the connecting and power-sync cable

- Do not damage the cable.
- Do not pull, bend, or apply any other stress to the cable.

## Precautions When Moving the PCR-LE

Disconnect the cable(s) when moving the PCR-LE series to the installation location or when transporting the PCR-LE. Moving a PCR-LE series with a cable connected to the phase board may result in breakage of the cable or connector.

## Installing the board on the PCR-LE

The 3P05-PCR-LE can be installed by inserting the U, V, and W phase boards into SLOT1 of the three PCR-LE series, respectively.

- 1 Check that the POWER switch of PCR-LE is off.**
- 2 Touch a grounded metal object (for example, the metal parts of the PCR-LE rear panel) to discharge any static electricity from your body.**
- 3 Remove the screws that are holding the SLOT 1 cover in place on the rear panel, and remove the cover from the panel.**
- 4 Hold the panel parts of the board so that the printed circuit board side is facing up.**
- 5 Insert the board into the slot so that the printed circuit board's connector is inserted into the connector at the back of the slot.**
- 6 Insert the board all the way into the slot.**
- 7 Use the screws that you removed in step 3 to fix the board in place in the panel.**
- 8 Follow the same procedure to install the other two boards.**  
This completes installation of the phase board.

When a 3P05-PCR-LE has been inserted into the slot1 of a PCR-LE series, that power supply can be used only in a three-phase system. To use the power supply in a single-phase system, the phase board must be removed from the slot1.

## Connecting the boards

Use the connecting cable to connect the boards.

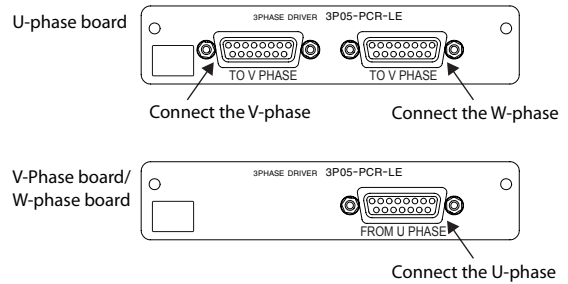

- 1 Check that the POWER switch of PCR-LE is off.**
- 2 Place the three PCR-LE as close to each other as possible.**  
Arrange them so that no stress is applied to the connecting cable. A PCR-LE power supply with the U phase board installed plays the role of the master unit that controls other power supplies.  
  
For the connection as shown below, you need the optional connecting cable (150 cm/ 280 cm). To perform parallel three-phase operation, place the U phase to the center.
- 3 Connect the "TO V PHASE" of U-phase unit and the "FROM U PHASE" of V-phase unit firmly with the connecting cable using a screwdriver.**  
Do not remove the attached core from the cable. If you do, reattach it (be sure to wrap the cable around the core once (2 turns)).
- 4 Follow the same procedure to connect the "TO W PHASE" of U-phase unit and the "FROM U PHASE" of W-phase unit with the connecting cable.**  
Do not remove the attached core from the cable. This completes connection of the boards.

## Operation Check

Check the operation of the PCR-LE series before you perform three-phase operation.

Check the following items with no load connected. For detail of settings, see the PCR-LE series operation manual.

- POWER switch ON
- Voltage setting
- OUTPUT ON/OFF
- Voltage-range switching

If a trouble is occurring on even one unit, you will not be able to perform three-phase operation.

# Connecting the Load

For detail of handling the terminal block tray and OUTPUT terminal block, see the PCR-LE series setup guide.

The PCR-LE Series OUTPUT terminal block (not included on the PCR500LE) is wired after you first pull out the terminal block tray. The terminal box covers ensure that you don't touch the unwired terminals.

## ⚠ WARNING

### Risk of electric shock.

- Before you connect cables to the OUTPUT terminal block, be sure to turn the POWER switch off, and then remove the power plug from the outlet or turn off the switchboard.
- Do not use the terminal block with the terminal cover removed.

## ⚠ CAUTION

### Risk of malfunction.

- Do not connect the PCR-LE series in a delta wiring configuration.
- If you are grounding the output, make sure that the isolation voltage does not exceed 300 V.

### - Note -

If the neutral point is omitted, there are cases in which it will not be possible to produce the rated power.

Use noncombustible wires that have diameters that correspond to the output current to connect to the load.

## Requirements of single-core wires that are used to connect to the load

Nominal cross-sectional area[mm <sup>2</sup> ]	AWG (reference cross-sectional area; mm <sup>2</sup> )	Allowable current* (A; at Ta = 30 °C, 86 °F)
0.9	18 (0.82)	17
1.25	16 (1.31)	19
2	14 (2.08)	27
3.5	12 (3.31)	37
5.5	10 (5.26)	49
8	8 (8.37)	61
14	6 (13.3)	88
22	4 (21.15)	115

\*1. Excerpt from Japanese laws related to electrical equipment.

The values vary depending on conditions such as the wire covering (insulator), the wire material (allowable temperature), and whether there are multiple cores in the cable. For cables other than those specified in this table, consult with a qualified engineer.

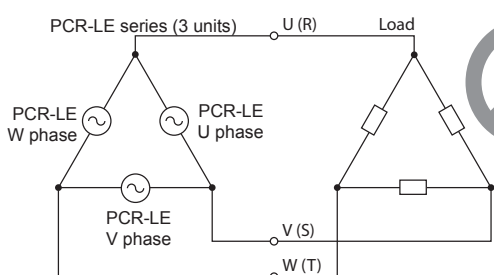
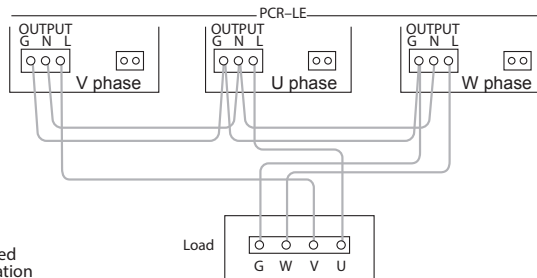
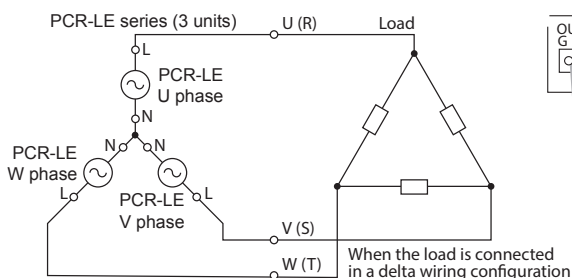
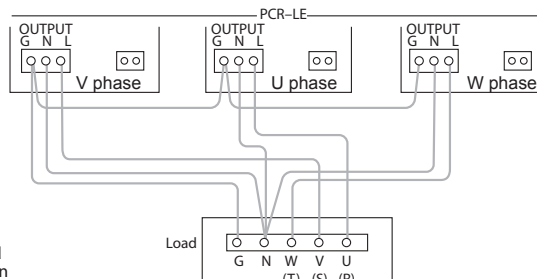
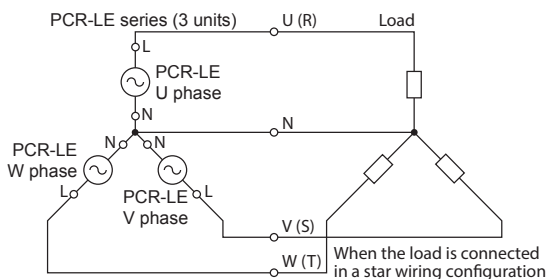

Do not connect the PCR-LE series in a delta wiring configuration.

# Connecting the Load (Cont.)

Parallel three-phase connection (when switches are used)

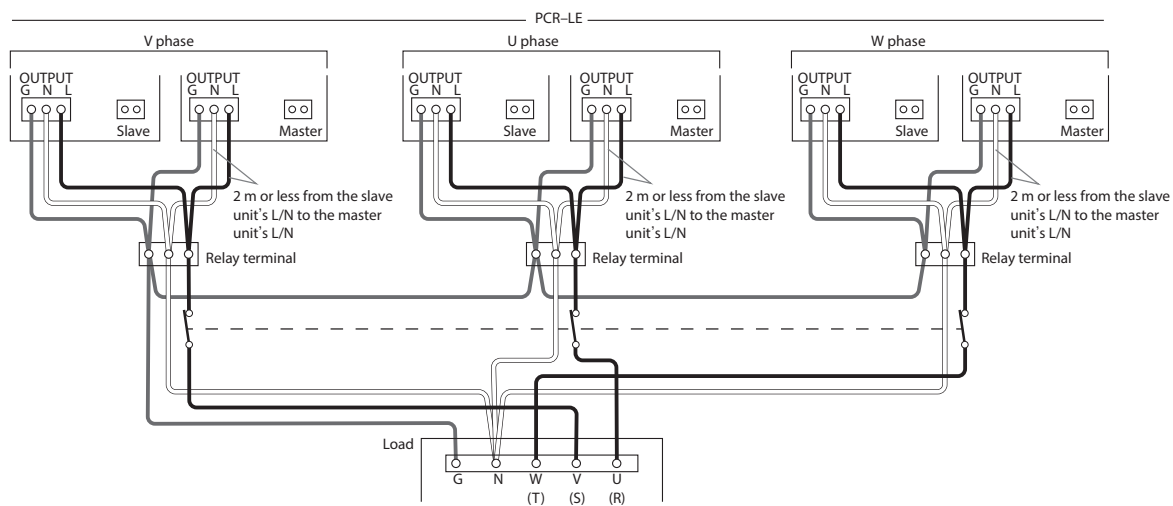

# Turning the Power On

## ■ Power ON

When turning ON all three PCR-LE power supply POWER switches, complete all turn-ONs within 15 seconds. Alternatively, turn the POWER switches of all power supplies ON simultaneously.

The firmware version is displayed for a few seconds on the U-phase unit, and then the home position (the basic screen) is displayed if there are no errors. Three-phase output is controlled from the U-phase unit.

“V-PHASE” is displayed on the V-phase unit. “W-PHASE” is displayed on the W-phase unit. You cannot use the panels of the V-phase and W-phase units.

“V-PHASE” is displayed on the V-phase unit. You cannot use the panel of the V-phase unit.

If the system that you are using is different from the previous one that you used, the system starts with the factory default settings except for the following items.

- Remote control setting
- Screen brightness
- Trigger input, trigger output, and status output polarities

## ■ Power OFF

Turn off all POWER switches.

For emergency situations, we recommend that you insert a circuit breaker that separates the entire system from the switchboard.

## Synchronizing the POWER Switches

You can configure the system so that when you turn on a PCR-LE, all the other PCR-LEs also turn on.

### ⚠ WARNING

**Risk of electric shock. Before you connect cables to the J1/J2 connector, be sure to turn the POWER switch off, and then remove the power plug from the outlet or turn off the switchboard.**

## ■ Power ON

**1 Check that the POWER switches of PCR-LEs are off.**

**2 Use the power-sync cable to connect the J1 connector and the J2 connector on the PCR-LE rear panels.**

Do not connect two J1 connectors to each other or two J2 connectors to each other. Insert the cable firmly into the connectors until they are locked in place.

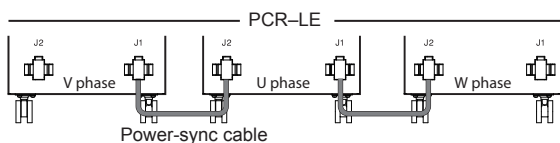

**3 Set the POWER SELECTOR switch of the PCR-LE whose J1 connector is open to MASTER.**

The POWER SELECTOR switch is on the front panel (on the rear panel on the PCR500LE).

**4 Set the POWER SELECTOR switches of the other PCR-LEs to SLAVE.**

**5 Turn ON the POWER switches of the PCR-LEs whose POWER SELECTOR switches have been set to SLAVE.**

Even when you turn ON the POWER switches, the PCR-LEs do not turn on.

**6 Turn ON the POWER switch of the PCR-LE whose POWER SELECTOR switch has been set to MASTER.**

The PCR-LEs that have been set to SLAVE will also turn on.

### - Note -

The power signal travels from the J2 connector to the J1 connector. Operating the POWER switch of the PCR-LE whose J1 connector is open will cause the other PCR-LEs to respond in sync.

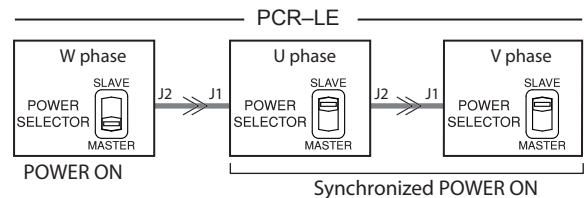

## ■ Power OFF

When you turn OFF the POWER switch of the PCR-LE whose POWER SELECTOR switch has been set to MASTER, the PCR-LEs that have been set to SLAVE also turn off.

### Power OFF in an Emergency

In an emergency, turn OFF all POWER switches.

### ■ To Stop Synchronization

Hold down the locking tab of the power-sync cable, and pull it free of the unit.



Set the POWER SELECTOR switches of all PCR-LEs to “MASTER”.

## Performing Three-Phase Output

For details on how to configure the settings to perform three-phase output, see the operation manual included with the PCR-LE series.

The screen captures used in the PCR-LE series operation manual are examples. They may differ from the screens that are displayed when you are setting three-phase output.



环境保护使用期限  
Environment-friendly Use Period

该标记为适用于在中华人民共和国销售的电子信息产品的环境保护使用期限。只要遵守有关该产品的安全及使用注意事项，从制造年月起计算，在该年度内，就不会对环境污染、人身、财产产生重大的影响。

产品的废弃请遵守有关规定。产品的制造年月可以在以下网址中确认。

<http://www.kikusui.co.jp/pi/>

### 毒有害物质或元素名称及含有标示

Name of hazardous materials and symbol of element in the equipment and quantity

有毒有害物质或元素					
铅 Pb	汞 Hg	镉 Cd	六价铬 Cr(VI)	多溴联苯 PBB	多溴二苯醚 PBDE
×	○	○	○	○	○

本表格依据 SJ/T 11364 的规定编制。

- ：该部件所有均质材料的有毒有害物质的含量不超过 GB/T 26572 标准所规定的极限值要求。
- ×：该部件至少有一种均质材料的有毒有害物质的含量超过 GB/T 26572 标准所规定的极限值要求。