

KRA3 and KRA150 are rack mount adapters designed according to EIA and JIS standards.

Parts list

Check that all parts are included and that the parts have not been damaged during transportation. If any of the parts are damaged or missing, contact your Kikusui agent or distributor.

No.	Name	Qty	No.	Name	Qty
①	Mounting angles (for KRA3/KRA150)	2	⑨	Holder brackets (1)	2
②	Right side plate	1	⑩	Holder brackets (2)	2
③	Left side plate	1	⑪	Flat head screws M3 × 6	KRA3: 10 KRA150: 14
④	Front rail	1	⑫	Pan head screws M3 × 8	2
⑤	Rear rail	1	⑬	Pan head screws M3 × 12	2
⑥	Mounting rail	1	⑭	Oval countersink screws M5 × 14	4
⑦	Bolts	4	⑮	Finishing washers M5	4
⑧	Metal stoppers	6	⑯	Blank panel (for KRA150)	1

Assembly of rack adapter

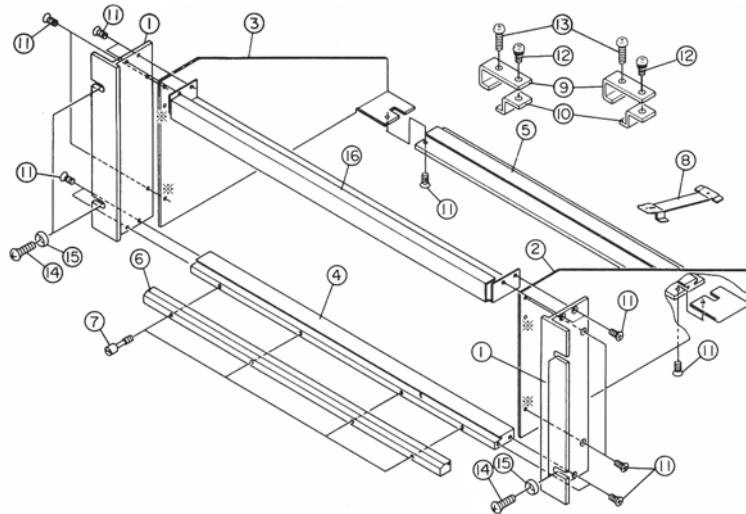

Blank panel ⑯ is used only for KRA150.

When assembling the mounting angles for KRA3, use the holes marked "※".

Assembly preparations for equipment

1. Remove the parts attached to the handle on the top surface.

Pull cover ㉓ up to remove it.

2. Remove the rubber feet on the bottom surface.

3. Remove the seal from the bottom surface to open the hole.

4. Fit the metal stopper ⑧ as shown in Fig. 1, and push it with your finger in the direction of the arrow.

The resulting condition is shown in Fig. 2.

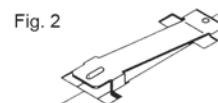
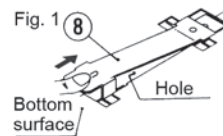
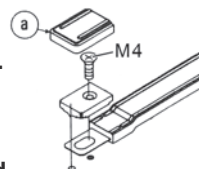

Procedure for assembling to your equipment

1. Fit the equipment and front rail ④ and push it in.

When doing this, push it up when inserting to prevent the metal stopper ⑧ installed to the bottom surface of the equipment from contacting the front rail ④. Check that the metal stopper ⑧ is completely fitted into the groove of the rear rail ⑤ and that the catch on the bottom surface of the equipment is fitted completely into the groove in the front rail ④.

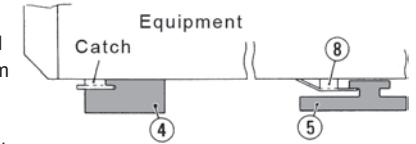

2. Push in the mounting rail ⑥ in the direction of the arrow as shown in figure, then tighten at four places with bolts ⑦.

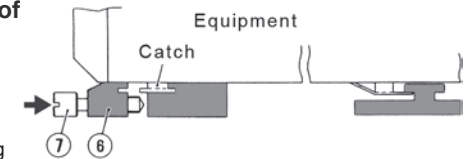

3. Installing to the rack.

Use the oval countersink screws M5 × 14 ⑭ and finishing washers M5 ⑮.

Method of using holder brackets to prevent equipment from swaying to side

Note: This applies only if there is a blank panel. Use the holder brackets when assembling the equipment in order to prevent the equipment from swaying to the side.

1. Insert the holder brackets ⑨ and ⑩ in the groove of the rail ⑤.

2. Put them in tight contact with the left and right sides of the equipment, then tighten the screws ⑫ and ⑬ to hold them in position.

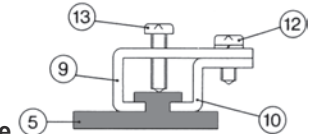

Method of assembling the blank panel (option)

1. After inserting the catch at the bottom surface of the blank panel into the groove of the front rail ④.

2. Insert the catch securely into the groove of the mounting rail ⑥, then tighten with bolts ⑦.

3. Secure in position with the supplied screws M3 × M10.

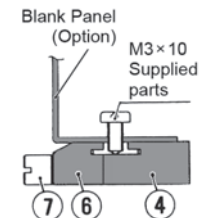

Specifications

Allowable Load		Max. 20 kg
Weight	KRA3	1.2 kg
	KRA150	1.4 kg

CAUTION

The instrument may fall. Install the suitable support angles applying to the used rack system to support the instrument.

KIKUSUI ELECTRONICS CORP.

1-1-3 Higashiyamata, Tsuzuki-ku, Yokohama,
224-0023, Japan

Tel: +81-45-482-6353 Fax: +81-45-482-6261

Website

<http://www.kikusui.co.jp/en>

The newest version of the operation manual can be downloaded from Download service of Kikusui website.

©2015

