

Part No. Z1-003-062, IA003161

Jan. 2004

OPERATION MANUAL

Time Interval Jitter Meter

KJM6310

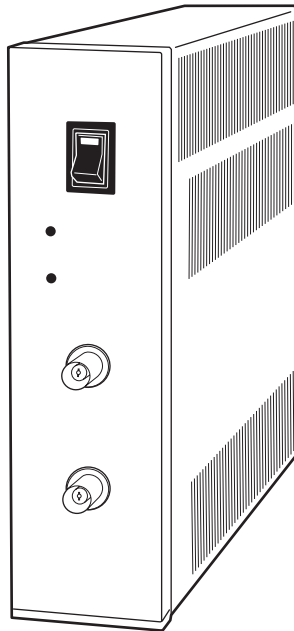

Use of Operation Manual

Please read through and understand this Operation Manual before operating the product. After reading, always keep the manual nearby so that you may refer to it as needed. When moving the product to another location, be sure to bring the manual as well.

If you find any incorrectly arranged or missing pages in this manual, they will be replaced. If the manual it gets lost or soiled, a new copy can be provided for a fee. In either case, please contact Kikusui distributor/agent, and provide the “Kikusui Part No.” given on cover.

This manual has been prepared with the utmost care; however, if you have any questions, or note any errors or omissions, please contact Kikusui distributor/agent.

Microsoft and Visual Basic are registered trademarks of Microsoft Corp., U.S.A.

Reproduction and reprinting of this operation manual, whole or partially, without our permission is prohibited.

Both unit specifications and manual contents are subject to change without notice.

© 2004 Copyright Kikusui Electronics Corporation

Printed in Japan

Safety Symbols

For the safe use and safe maintenance of this product, the following symbols are used throughout this manual and on the product. Understand the meanings of the symbols and observe the instructions they indicate (the choice of symbols used depends on the products).

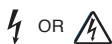

Indicates that a high voltage (over 1 000 V) is used here. Touching the part causes a possibly fatal electric shock. If physical contact is required by your work, start work only after you make sure that no voltage is output here.

DANGER

Indicates an imminently hazardous situation which, if ignored, will result in death or serious injury.



Indicates a potentially hazardous situation which, if ignored, could result in death or serious injury.



Indicates a potentially hazardous situation which, if ignored, may result in damage to the product and other property.



Shows that the act indicated is prohibited.



Is placed before the sign “DANGER,” “WARNING,” or “CAUTION” to emphasize these. When this symbol is marked on the product, see the relevant sections in this manual.



Indicates a protective conductor terminal.



Indicates a chassis (frame) terminal.

Safety Precautions

The following safety precautions must be observed to avoid fire hazard, electrical shock, accidents, and other failures. Keep them in mind and make sure that all of them are observed properly.



Users

- This product must be used only by qualified personnel who understand the contents of this operation manual.
- If it is handled by disqualified personnel, personal injury may result. Be sure to handle it under supervision of qualified personnel (those who have electrical knowledge.)
- This product is not designed or produced for home-use or use by general consumers.



Purposes of use

- Do not use the product for purposes other than those described in the operation manual.

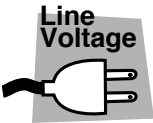

Input power

- Use the product with the specified input power voltage.
-
-



Cover

- There are parts inside the product which may cause physical hazards. Do not remove the external cover.

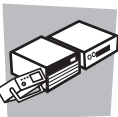

Installation

- When installing products be sure to observe "1.2 Installation" described in this manual.



Relocation

- Turn off the power switch and then disconnect all cables when relocating the product.
- Be sure the operation manual be included when the product is relocated.



Maintenance and checking

- To avoid electrical shock, be absolutely sure to unplug the AC power cord or stop applying power before performing maintenance or checking.
- To maintain performance and safe operation of the product, it is recommended that periodic maintenance, checking, cleaning, and calibration be performed.



Service

- Internal service is to be done by Kikusui service engineers. If the product must be adjusted or repaired, contact Kikusui agent/distributor.
- Do not disassemble or modify the product. If it must be modified, contact Kikusui distributor/agent.

Overvoltage category

For the safe use of equipment, IEC60664 (Insulation coordination for equipment within low-voltage systems) classifies circuits into four categories by an occurrence level of transient voltage. When you connect equipment to a power line or connect a measuring instrument to these places, make sure of the applied overvoltage category. This instrument is designed to operate from the overvoltage category II.

Overvoltage category I

- Equipment of overvoltage category I is equipment for connection to circuits in which measures are taken to limit transient overvoltages to an appropriately low level. Examples are protected electronic circuits.

Overvoltage category II

- Equipment of overvoltage category II is energy-consuming equipment to be supplied from the fixed installation. Examples of such equipment are appliances, portable tools and other household and similar loads. If such equipment is subjected to special requirements with regard to reliability and availability, overvoltage category III applies.

Overvoltage category III

- Equipment of overvoltage category III is equipment in fixed installations and for cases where the reliability and the availability of the equipment is subject to special requirements. Examples of such equipment are switches in the fixed installation and equipment for industrial use with permanent connection to the fixed installation.

Overvoltage category IV

- Equipment of overvoltage IV is for use at the origin of the installation. Example of such equipment are electricity meters and primary overcurrent protection equipment.

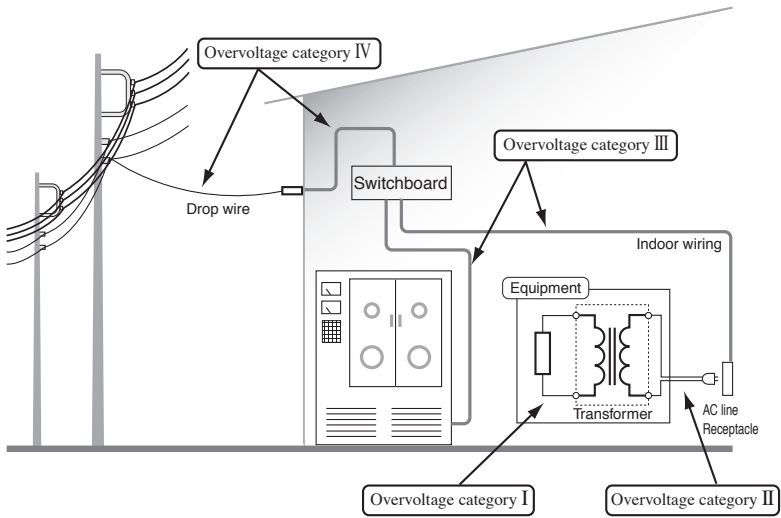

Contents

Safety Symbols- - - - -	I
Safety Precautions - - - - -	II
Overvoltage category - - - - -	IV
Preface	P-1
<hr/>	
Chapter 1 Setup	1-1
<hr/>	
1.1 Checking the Package Contents - - - - -	1-1
1.2 Installation - - - - -	1-2
1.3 Precautions When Moving the KJM6310 - - - - -	1-4
1.4 Connecting the DC Power Supply - - - - -	1-4
Chapter 2 Names and Functions of Parts	2-1
<hr/>	
2.1 Front Panel - - - - -	2-1
2.2 Rear Panel- - - - -	2-2
Chapter 3 Operation	3-1
<hr/>	
3.1 Connecting the Signal - - - - -	3-1
3.2 Function Setup- - - - -	3-5
3.3 Trigger Edge Selection - - - - -	3-6
3.4 Symmetry and Slice Level - - - - -	3-8
3.5 Delay Adjustment - - - - -	3-11
Chapter 4 RS-232C Control	4-1
<hr/>	
4.1 Cable Connection and Initial Setup - - - - -	4-1
4.2 Messages and Terminators- - - - -	4-2
4.2.1 Messages - - - - -	4-2
4.2.2 Terminator - - - - -	4-2
4.3 Device Messages - - - - -	4-3
4.4 Sample Program- - - - -	4-13
Chapter 5 Maintenance	5-1
<hr/>	
5.1 Cleaning - - - - -	5-1
5.2 Inspection - - - - -	5-1
5.3 Calibration - - - - -	5-1
5.4 Troubleshooting- - - - -	5-2

6.1	Electrical Specifications	-----	6-1
6.2	General Specifications	-----	6-3
6.3	External Dimensions	-----	6-4

Preface

About This Manual

This operation manual describes the KJM6310 Time Interval Jitter Meter.

■ ROM version of the product to which this manual applies

- Ver. 1.0 X

The *IDN? message is used to verify the version. For a description of the *IDN? message, see chapter 4, "RS-232C Control."

When contacting us about the product, please provide us the version number and the manufacturing number that are attached to the rear panel.

Product Overview

The KJM6310 is an instrument used to measure jitters of CDs. It can measure the RF to CLOCK jitter by the time interval method.

The KJM6310 can be used for the development, adjustment, and inspection of optical pickups.

It is a compact unit for embedded applications that is designed to maximize the work efficiency on the production line.

To provide the KJM6310 at low cost, the item to be measured has been limited to CDs, and meters and panel switches have been removed. The KJM6310 is designed to be used on a single adjustment line. However, peripheral circuits required for making measurements such as symmetry follow-up circuit, PLL clock regeneration circuit, and phase-difference correction circuit are equipped as standard.

This chapter describes the procedures of unpacking and preparation of the KJM6310 before use.

1.1 Checking the Package Contents

When you receive the product, check that all accessories are included and that the product and accessories have not been damaged during transportation. Fig. 1-1 gives a list of accessories.

If any of the accessories are damaged or missing, contact your Kikusui agent or distributor.

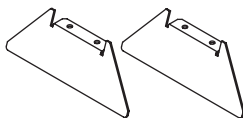

Stand (2 pcs.)
[E7-000-002]



Attachment screws (4 pcs.)
[M3-012-021]



Operation manual (1 pc.)
[Z1-003-062]

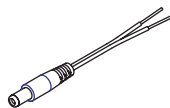

DC plug (1 pc.)
[91-82-1610]

Fig.1-1 Accessories

NOTE

- We recommend that all packing materials be saved, in case the product needs to be transported at a later date.
-

1.2 Installation

How to install the KJM6310

- The KJM6310 is designed for embedded application and provides attachment screw holes on the side and bottom panels. To fix the KJM6310 in place, use these screw holes. If you are not fixing the KJM6310 in place, attach the stand provided to the bottom panel and place the KJM6310 so that it stands up. Secure adequate space around the KJM6310 so that air can circulate around it.

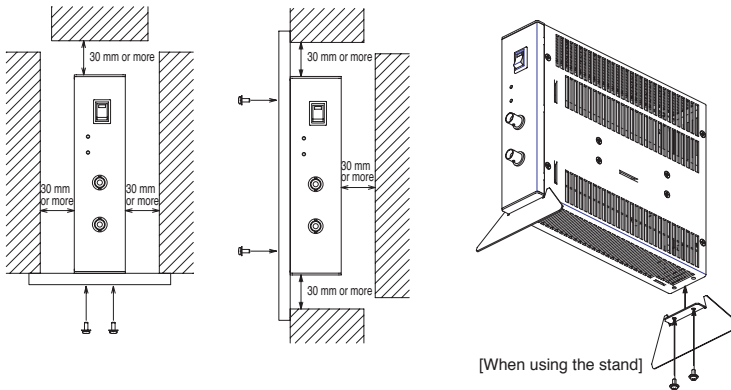

Precautions concerning installation location

This section describes the precautions to be taken when installing the KJM6310. Make sure to observe them.

- **Do not use the KJM6310 in a flammable atmosphere.**

To prevent the possibility of explosion or fire, do not use the KJM6310 near alcohol, thinner or other combustible materials, or in an atmosphere containing such vapors.

- **Avoid locations where the KJM6310 is exposed to high temperature or direct sunlight.**

Do not place the KJM6310 near a heater or in areas subject to drastic temperature changes.

Operating temperature range: 0 °C to 40 °C

Spec guaranteed temperature range: 15 °C to 35 °C

Storage temperature range: -20 °C to 60 °C

■ **Avoid humid environments.**

Do not place the KJM6310 in high-humidity locations--near a boiler, humidifier, or water supply.

Operating humidity range: 20 % to 85 % RH (no condensation)

Storage humidity range: 0 to 90 % RH (no condensation)

Condensation may occur even within the operating humidity range. In such cases, do not use the KJM6310 until the condensation dries up completely.

■ **Do not place the KJM6310 in a corrosive atmosphere.**

Do not install the KJM6310 in a corrosive atmosphere or in environments containing sulfuric acid mist, etc. This may cause corrosion of various conductors and bad contacts of connectors inside the KJM6310 leading to malfunction and failure, or in the worst case, a fire.

■ **Do not place the KJM6310 in a dusty location.**

Accumulation of dust can lead to electric shock or fire.

■ **Do not place the KJM6310 on an inclined surface or location subject to vibrations.**

The KJM6310 may fall or tip over causing damages and injuries.

■ **Do not use the KJM6310 in a location subject to strong magnetic or electric fields.**

The KJM6310 may malfunction and cause electric shock or fire.

■ **Do not place objects on top of the KJM6310.**

Placing objects on top of the KJM6310 can cause failures (especially heavy objects).

1.3 Precautions When Moving the KJM6310

When moving the KJM6310 to the installation location or when transporting the unit, note the following points.

■ Always turn off the POWER switch.

Moving the KJM6310 with the power on may result in electric shock or damage.

■ When moving the KJM6310, remove all wires that are connected.

Moving the KJM6310 with the cables connected can cause wires to break or injuries due to the KJM6310 falling over.

■ When transporting the KJM6310, be sure to use the original packing materials.

If packing materials are not used, damage may result from vibrations or from the KJM6310 falling during transportation. If you need packing materials, contact your Kikusui agent or distributor.

1.4 Connecting the DC Power Supply

Using the DC plug provided, connect a 15-V DC power supply to the DC INPUT connector on the rear panel.

Input line voltage range 14.5 VDC to 15.5 VDC

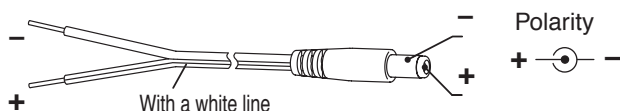

⚠ CAUTION

- Be sure the polarity of the connector is correct. If the polarity is reversed, the internal fuse will blow.
- Do not connect a power supply outside the input line voltage range as it may cause a malfunction.

⚠ WARNING

- The KJM6310 is designed to be connected to a power supply classified as Overvoltage Category I (SELV-E). Do not connect to a power supply classified as Overvoltage Category II, III, or IV. For a description of the Overvoltage Category, see "Overvoltage Category" on page IV.

Chapter 2 Names and Functions of Parts

This chapter describes the names and functions of switches, displays, connectors, and other parts of the front panel and rear panel.

2.1 Front Panel

IN MEAS RANGE LED

Illuminates when measurement can be made and the measured value is less than or equal to 20 %. This LED illuminates for approximately 1 s for self-testing at power-up.

ERROR LED

Error detection LED. This LED illuminates when an error occurs such as when the RF signal is not connected, when the signal amplitude is insufficient, or when the clock frequency is not correct. This LED illuminates for approximately 1 s for self-testing at power-up. If an error is detected during the self-test, the LED changes to blinking. In addition, the LED illuminates for a certain period when a communication error occurs on the RS-232C interface.

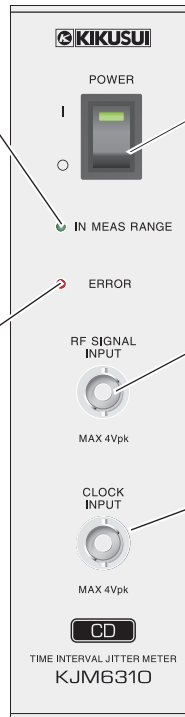

POWER switch

Switch used to turn on/off the power. When the power is on, the LED at the top section of the switch illuminates.

RF SIGNAL INPUT connector (BNC)

RF signal input. The input impedance is approximately 50 Ω .

CLOCK INPUT connector (BNC)

Clock signal input. The input impedance is approximately 50 Ω .

2.2 Rear Panel

JITTER OUT connector (BNC)

Outputs the jitter sampling waveform before it is converted to rms values. The output impedance is approximately 600 Ω.

DC INPUT connector

DC INPUT connector
Used to connect the input power cable.

Compatible plug
EIAJ RC-6705

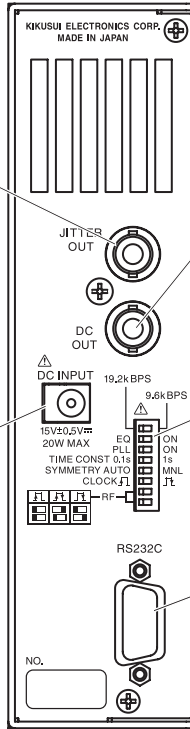
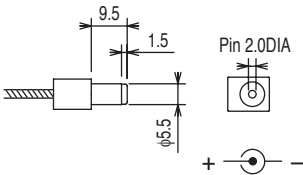

DC OUT connector (BNC)

Outputs DC voltage that is proportional to the measured value. (0.2 V/%)
The output impedance is approximately 600 Ω.

Function setup switches

These switches are used to set the functions of the KJM6310.

RS-232C connector

Connector for external control.
(D-SUB 9 pin, attachment screws M2.6).

This chapter describes the basic operations of the KJM6310 from the panel.

3.1 Connecting the Signal

Connect the RF signal to the RF SIGNAL INPUT connector.

To measure time intervals using two signals, connect the clock signal to the CLOCK INPUT connector.

Refer to the figures to connect the DUT to the KJM6310 and set the functions according to the input signal.

1. Time interval jitter measurement using sliced RF signal and regenerated clock signal (measurement using two binary-coded signals)

Function setup switches	
PLL	OFF
SYMMETRY	MANUAL
CLOCK EDGE	Any
RF EDGE *1	
	either

*1 Do not turn both RF EDGE switches to  (ON).

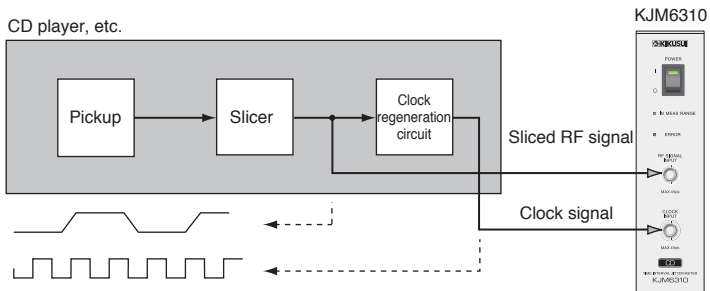





Fig.3-1

2. Time interval jitter measurement using pickup output signal and regenerated clock signal

Function setup switches			
PLL	OFF		
SYMMETRY	AUTO (or AUTO+OFST) ^{*1}		
CLOCK EDGE	Any		
RF EDGE ^{*2}			
	positive	either	negative

*1 Use RS-232C control

*2 Do not turn both RF EDGE switches to  (ON).

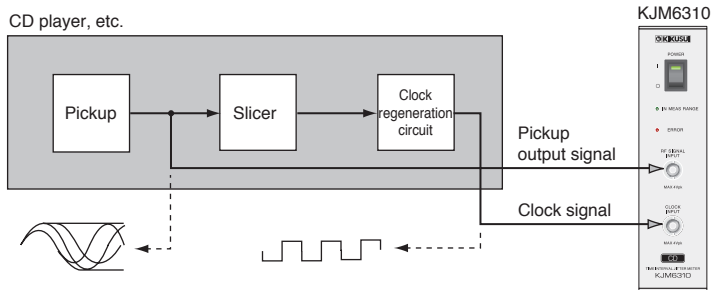





Fig.3-2

3. Time interval jitter measurement using only sliced RF signal

Function setup switches			
PLL	ON		
SYMMETRY	MANUAL		
CLOCK EDGE	Any		
RF EDGE *1			
	positive	either	negative

*1 Do not turn both RF EDGE switches to  (ON).

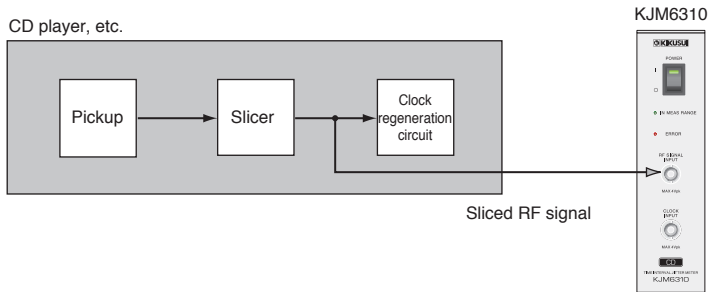





Fig.3-3

4. Time interval jitter measurement using only pickup output signal

Function setup switches			
PLL	ON		
SYMMETRY	AUTO (or AUTO+OFST) ^{*1}		
CLOCK EDGE	Any		
RF EDGE ^{*2}			
	positive	either	negative

*1 Use RS-232C control

*2 Do not turn both RF EDGE switches to  (ON).

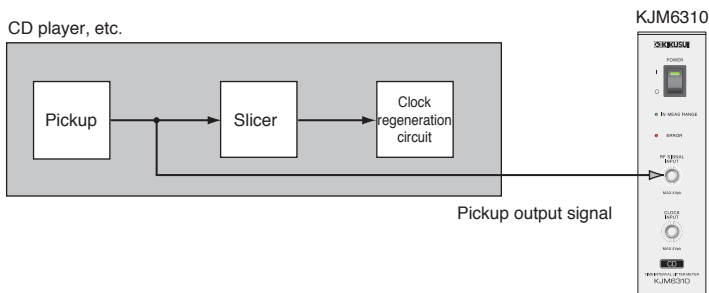

Fig.3-4





3.2 Function Setup

There are two methods for setting the internal functions of the KJM6310.

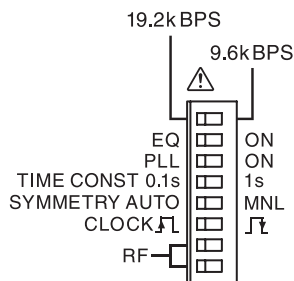
1. By using the function setup switches on the rear panel.
2. By transmitting messages via the RS-232C interface.

The table below shows the possible combinations of the setup through the function setup switches.



SW	Operation when set to	Operation when set to	
	<input type="checkbox"/> (OFF)	<input checked="" type="checkbox"/> (ON)	
BPS (baud rate)	19200 BPS	9600 BPS	
EQ ^{*1}	–	–	
PLL	OFF	ON	
TIME CONST	0.1 s	1 s	
SYMMETRY	AUTO	MANUAL (0 V)	
CLOCK EDGE	 positive	 negative	
RF EDGE ^{*2}			
	positive	either	negative

*1 This model does not have an equalizer circuit. Keep this switch turned off at all times.

*2 Do not turn both RF EDGE switches to (ON).

After setting the switches, DELAY which is not indicated in the table is set to AUTO, and SYMMETRY LEVEL (when set to SYMMETRY MANUAL) is set to 0 V.

The BPS (baud rate) switch setting takes effect the next time the KJM6310 is powered up. Other switch settings take effect immediately. All settings except the BPS (baud rate) setting can be configured using RS-232C command messages. The settings that actually take effect are those specified last.

Recommended setup

For the clock signal, select the edge that is synchronized to the latch time of the RF signal sliced by the CD player, drive, etc.

-
- NOTE** • If the RF signal to be measured is already converted to one edge, be sure to set the trigger edge of the RF signal of the KJM6310 to rising or falling to match the signal. Measurement is not possible if both edges are selected.
-

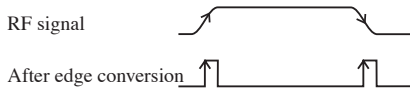

Fig.3-6

In the above case, set the trigger edge of the RF signal of the KJM6310 to rising.

3.4 Symmetry and Slice Level

In the DVD modulation (8-16 Modulation) or CD modulation (EFM), the time ratio of 1s and 0s are 50:50 when the bit sequence is averaged. This is expressed as DSV (Digital Sum Value) being 0. It signifies that the signal contains no DC component. However, when signals are recorded to the disk, various conditions such as the optical power during mastering and the developing time cause the pit lengths of the disk to vary. Consequently, when the pits are read by the pickup, the RF signal will contain a DC component. This phenomenon is referred to as asymmetry. If the RF signal is sliced at the center of all amplitudes of the RF signal when the RF signal is binary-coded, the signal after slicing will have a DC component. The RF signal symmetry level refers to the level at which the signal after slicing will not have a DC component when the RF signal is sliced.

Operation when SYMMETRY mode is set to AUTO

The KJM6310 is equipped with a function that automatically controls the slice level to follow the symmetry level of the RF signal to correct the RF signal asymmetry. This function is achieved through feedback control so that the DC component of the sliced RF signal will be 0.

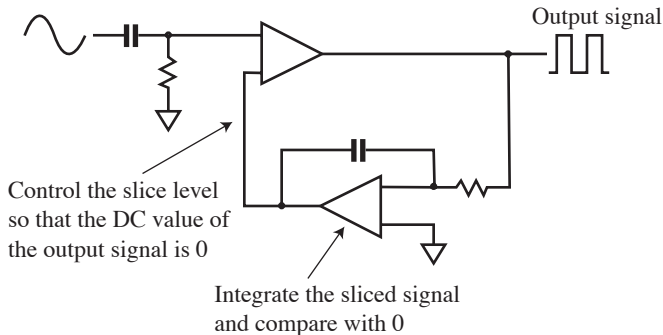

Fig.3-7

Fig. 3-7 shows a typical symmetry level follow-up circuit. By changing the level at which the input signal is sliced, the DC component of the sliced signal is changed and allows feedback control.

Operation when SYMMETRY mode is set to OFFSET

As opposed to the operation when SYMMETRY mode is set to AUTO, OFFSET allows offset to be placed on the slice level. This mode cannot be selected using the function setup switch. Use RS-232C control to set this mode. Likewise, use RS-232C control to set the OFFSET.

Operation when SYMMETRY mode is set to MANUAL

The symmetry level follow-up circuit is applied to the RF signal before slicing. When a signal with fast rise and fall times such as a square wave is input, the control range is narrowed. Feedback control may fail especially when the duty cycle of the signal is not 50 %. Therefore, when a sliced signal is input, the symmetry level must be made not to follow up the slice level.

To disable the follow-up function of the symmetry level, set SYMMETRY mode to MANUAL.

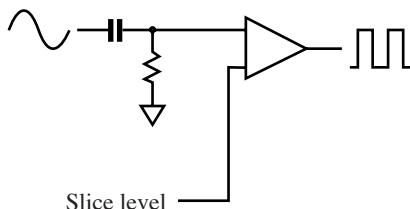

Fig.3-8

Fig. 3-8 shows the circuit when SYMMETRY mode is set to MANUAL. When set to MANUAL, the feedback control is cut off, and the slice level is applied directly from the DA converter. The variable range of the slice level is approximately $\pm 40\%$ when assuming the peak-to-peak amplitude of the input signal to be 100 %. However, as shown in Fig. 3-8, the slicer input is AC coupled, and a difference appears between the preset slice level and the actual slice level depending on the duty cycle of the input signal.

Example: When the signal's duty cycle is 50 %

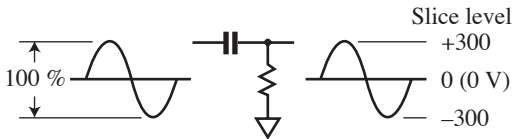

Fig.3-9

Since a signal having 50 % duty cycle such as a sinusoidal wave does not have a DC component as shown in Fig. 3-9, the preset slice level and the actual slice level match. Therefore, when slicing the signal at the center of the peak-to-peak amplitude of the signal, use the SYM:OFFS:LEV message to set the slice level to 0. Amplitude of 100 % corresponds the slice level reading of approximately to 600.

Example: When the signal's duty cycle is not 50 %

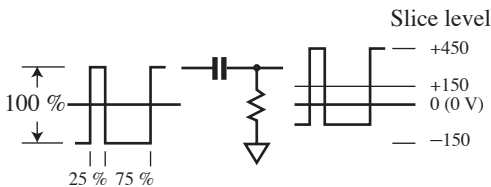

Fig.3-10

If a signal that does not have 50 % duty cycle is input as shown in Fig. 3-10, a DC offset is generated when the input is AC coupled. In the example given in Fig. 3-10, the duty cycle of the input signal is 25:75. Thus, after the signal is AC coupled, the signal shifts up by 25 %. Therefore, when slicing the signal at the center of the peak-to-peak amplitude of the signal, you must use the SYM:OFFS:LEV message to set the slice level approximately to 150.

If the duty cycle is not 50 %, check the signal using an oscilloscope or some similar means and set the optimum slice level by referring to the example above.

In addition, the frequency bandwidth of the RF input is approximately 60 MHz. Therefore, operation will fail on narrow pulses of which the pulse width falls below 15 ns, because of amplitude drop-outs.

3.5 Delay Adjustment

When measuring the RF signal jitter with respect to the clock signal, it is ideal for the average phase difference between the clock edge and RF signal edge to be 180° .

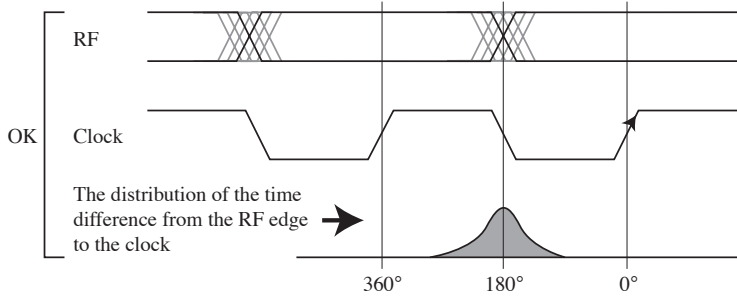

Fig.3-11

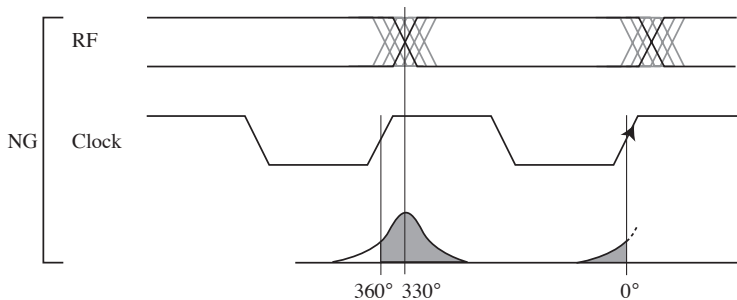

Fig.3-12

Fig. 3-11 and Fig. 3-12 show the timing charts for the cases when the phase difference between the RF and clock signals is 180° and 330° , respectively. Naturally, the jitter should be distributed over the range of 0° to 360° as shown in Fig. 3-11. However, the distribution crosses 0° and 360° in Fig. 3-12 resulting in a large sigma value. Proper jitter measurements are not possible in such conditions. Therefore, adjustment must be made so that the average phase difference between the two signals is 180° .

The delay circuit is used to make this adjustment.

The delay circuit places an appropriate delay on the clock signal, and the average phase difference between the two signals can be made 180° .

Adjustment procedure

1. Connect a DC voltmeter to the JITTER OUT connector.
Send a DELAY MODE message and set the MANUAL delay through the RS-232C interface.
2. Send a DELAY CONTROL message through the RS-232C interface.
3. Vary the value of the command so that the DC voltmeter reading is as close to 0 as possible.
The phase difference is at the optimum value when the voltmeter reading is 0 V.

This chapter describes remote control using the RS-232C interface.

4.1 Cable Connection and Initial Setup

Connect the 9-pin connector on the rear panel to the serial interface connector of your PC. Use a RS-232C cross cable to make the connection.

The baud rate of the KJM6310 can be set to 9600 bps or 19200 bps using the switches on the rear panel. (The setting is read during power up.)

Configure the settings on the PC to match the interface specifications below.

Baud rate	9600 or 19200 bps
Data length	8 bits
Parity	NONE
Stop bit	1 bit
Flow control	Xon/Xoff control

(Send request is ASCII 11H, and stop request is ASCII 13 H.)

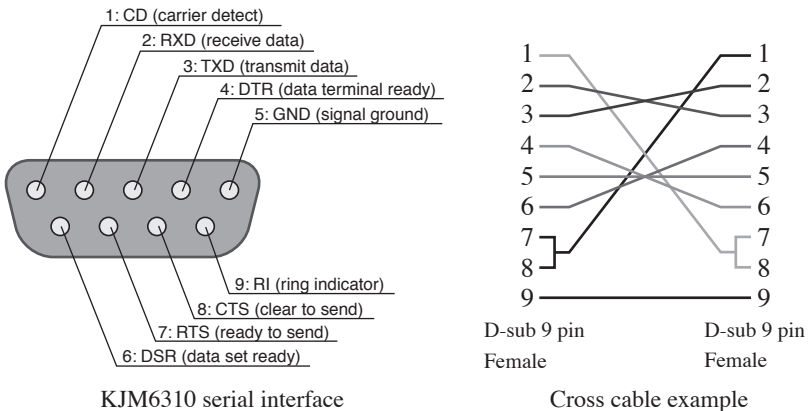

Fig.4-1 9-pin AT type connector

4.2 Messages and Terminators

This section describes the terminology used in this operation manual concerning the communication between the computer (controller) and the KJM6310 (device).

4.2.1 Messages

Program messages refer to instructions sent from the computer to the KJM6310. Response messages refer to responses sent from the KJM6310 to the computer. Program messages can be divided into command messages, which execute certain functions of the KJM6310 or change settings, and query messages, which query the settings of the KJM6310.

To notify that the processing of a message is complete, the KJM6310 sends a response message to the computer (referred to as an acknowledge message) in response to each program message sent to the KJM6310. Below are the messages sent by the KJM6310.

When a command message is sent

“OK” is returned upon successful completion.

“ERROR” is returned when an error occurs (syntax error for example).

When a query message is sent

A response message for the query is returned upon successful completion.

“ERROR” is returned when an error occurs (syntax error for example).

A space (ASCII: 20 h) is required between the command program header and data.

4.2.2 Terminator

The message terminator indicates the end of a message. Use CR (ASCII: 0Dh), LF (ASCII: 0Ah), or CR+LF (ASCII: 0Dh, 0Ah) for the command message terminator.

Use CR+LF (ASCII: 0Dh, 0Ah) for the query message terminator.

4.3 Device Messages

Device messages refer to program messages and response messages that the KJM6310 supports.

This section describes the device messages one by one.

Program messages are not case-sensitive. Response messages are returned in upper-case.

Abbreviated form

Abbreviations are provided for program messages and some of the character program data.

The device message inside the parentheses is the abbreviated form of the device message name.

- Response messages are returned in the abbreviated form.

Special symbols and characters

Special symbols and characters used in this manual to describe program messages and response messages are defined as shown in Table 4-1.

Table 4-1 Definitions of special symbols and characters

Symbol and Character	Description
< >	Denotes program data. Do not include the enclosing characters in the actual program.
{ }	Characters and numbers delimited by “ ” in braces indicate that one of the items is to be selected. Do not include the enclosing characters in the actual program.
_	Denotes a space.

*CLS

Clears the error queue.

Program message

- Syntax

Command message: *CLS

(Example) Clear the error queue.

*CLS

*IDN?

Queries the model name and ROM version of the KJM6310.

Program message

- Syntax

Query message: *IDN?

Response message

In response to *IDN?, the model name of the KJM6310 is returned as shown in the following example:

(Manufacturer: KIKUSUI, model: KJM6310, and version: 1.00)

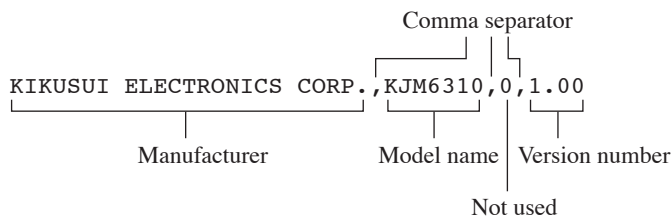

Fig.4-2 Response message to *IDN?

*RST

Resets the device to factory default settings. This is equivalent to setting all the function setup switches to OFF.

Program message

- Syntax

Command message: *RST

(Example) Reset to factory default settings.

*RST

CLOCK:TRIGGER:EDGE (CLOC:TRIG:EDG)

Sets the input trigger edge polarity of the CLOCK INPUT connector. Or, queries the current setting.

Program message

- Syntax

```
Command message: CLOC:TRIGGER:EDGE_
                  <{POSITIVE|NEGATIVE}>
                  CLOC:TRIG:EDG_<{POS|NEG}>
```

```
Query message:   CLOC:TRIGGER:EDGE?
                  CLOC:TRIG:EDG?
```

- Program data

Data format: Characters

Values: POS: ↑ (Rising)

NEG: ↓ (Falling)

(Example) Set the input trigger edge polarity to POS.

```
CLOC:TRIG:EDG POS
```

Response message

Returns the current setting in response to CLOC:TRIG:EDG? in characters (POS or NEG).

DELAY:CONTROL (DEL:CON)

Sets the level when the delay is set to MANUAL. Or, queries the current setting.

Program message

- Syntax

```
Command message: DELAY:CONTROL_<value>
                  DEL:CON_<value>
```

```
Query message:   DELAY:CONTROL?
                  DEL:CON?
```

- Program data

Data format: Integer

Values: -128 to +127

Resolution: 1

(Example) Set the level to 64 when the delay is set to MANUAL

```
DEL:CON 64
```

Response message

Returns the current setting in response to DEL:CON? in integers (-128 to +127).

DELAY:MODE (DEL:MOD)

Sets the delay mode. Or, queries the current setting.

Program message

- Syntax

```
Command message: DELAY:MODE_{AUTO
                  |MANUAL}>
                  DEL:MOD_{AUT|MAN}>
```

```
Query message:  DELAY:MODE?
                  DEL:MOD?
```

- Program data

Data format: Characters

Values: AUT: AUTO delay

MAN: MANUAL delay

(Example) Set the delay mode to AUTO.

```
DEL:MOD AUT
```

Response message

Returns the current setting in response to DEL:MOD? in characters (AUT or MAN).

ERROR? (ERR?)

Queries the error code from the error queue.

Program message

- Syntax

```
Query message: ERROR?
                  ERR?
```

Response message

Returns the current error code in response to ERR?.

(Example) When the error is a syntax error.

Returns -11.

Message Code	Error Description
0	NO ERROR
-11	Syntax error
-12	Out-of-range error
-13	Invalid keyword
-15	Invalid instruction
-18	Error queue overflow
-19	Errors other than the above

IMR?

Queries the measured value.

Program message

- Syntax

Query message: IMR?

Response message

Returns the measured value (0 or 1) in response to IMR?.

Message Code	Description
0	Above 20 %
1	Less than or equal to 20 %

JITTER? (JIT?)

Queries the jitter value being measured in percentages.

Range of measured values: 0.00 % to 20.00 %

* If measurement is not possible such as when there is no signal input or the clock frequency is outside the specifications, 100.00 is returned.

Program message

- Syntax

Query message: JITTER?

JIT?

Response message

Returns the jitter value being measured in percentages in response to JIT?.

(Example) When the jitter value is 12.34 %.

Returns 12.34.

JITTER:TIME? (JIT:TIM?)

Queries the jitter value being measured in ns.

Range of measured values: 0.00 ns to 50.0 ns

- * If measurement is not possible such as when there is no signal input or the clock frequency is outside the specifications, 100.0 is returned.

Program message

- Syntax

Query message: JITTER:TIME?

JIT:TIM?

Response message

Returns the jitter value being measured in ns in response to JIT:TIM?.

(Example) When the jitter value is 11.1 ns

Returns 11.1.

PLL

Turns on/off the PLL circuit. Or, queries the current setting.

Program message

- Syntax

Command message: PLL_{ON|OFF}>

Query message: PLL?

- Program data

Data format: Characters

Values: ON: PLL ON

OFF: PLL OFF

(Example) Turn on the PLL.

PLL ON

Response message

Returns the current setting in response to PLL? in characters (ON or OFF).

PLL:STATUS? (PLL:STAT?)

Queries the PLL circuit status.

Program message

- Syntax

Query message: `PLL:STATUS?`
`PLL:STAT?`

Response message

Returns the PLL circuit status (LOCK or UNLOCK) in response to PLL:STAT?.

Message Code	Description
LOCK	The PLL circuit is locked to the input signal.
UNLOCK	The PLL circuit is not locked to the input signal.

RF:TRIGGER:EDGE (RF:TRIG:EDG)

Sets the trigger edge polarity of the RF INPUT. Or, queries the current setting.

Program message

- Syntax

Command message: `RF:TRIGGER:EDGE_{POSITIVE|NEGATIVE|EITHER}>`
`RF:TRIG:EDG_{POS|NEG|EIT}>`
Query message: `RF:TRIGGER:EDGE?`
`RF:TRIG:EDG?`

- Program data

Data format: Characters

Values: POS: ↑ (Rising)
NEG: ↓ (Falling)
EIT: Rising or falling

(Example) Set the trigger edge polarity to POS.

`RF:TRIG:EDG POS`

Response message

Returns the current setting in response to RF:TRIG:EDG? in characters (POS, NEG, or EIT).

SYMMETRY:MODE (SYM:MOD)

Sets the symmetry mode. Or, queries the current setting.

Program message

- Syntax

```
Command message: SYMMETRY:MODE<{AUTO|OFFSET
                  |MANUAL}>
                  SYM:MOD_<{AUT|OFFS|MAN}>
Query message:   SYMMETRY:MODE?
                  SYM:MOD?
```

- Program data

Data format: Characters

Values: AUT: Set to AUTO
 OFFS: Set to OFFSET
 MAN: Set to MANUAL

(Example) Set the symmetry mode to AUT.

```
SYM:MOD AUT
```

Response message

Returns the current setting in response to SYM:MOD? in characters (AUT, OFFS, or MAN).

SYMMETRY:OFFSET:LEVEL (SYM:OFFS:LEV)

Sets the symmetry offset or slice level. Or, queries the current setting.

This message is valid only when the symmetry mode is OFFSET or MANUAL. The specified value is applied to the symmetry offset or slice level depending on the symmetry mode.

Program message

- Syntax

Command message: SYMMETRY:OFFSET
 :LEVEL_<value>
 SYM:OFFS:LEV_<value>

Query message: SYMMETRY:OFFSET:LEVEL?
 SYM:OFFS:LEV?

- Program data

Data format: Integer

Values: -128 to +127

Resolution: 1

(Example) Set the symmetry offset or slice level to 32.

SYM:OFFS:LEV 32

Response message

Returns the current setting in response to SYM:OFFS:LEV? in integers (-128 to +127).

SYMMETRY:SLICE:LEVEL (SYM:SLIC:LEV)

Queries the symmetry slice level.

The amplitude of the input signal (100 %) corresponds to a slice level value of approximately 600. Thus, the returned value is between -300 and +300.

- Syntax

Query message: SYMMETRY:SLICE:LEVEL?
 SYM:SLIC:LEV?

Response message

Returns the current setting in response to SYM:SLIC:LEV? in real numbers (-300 to +300).

TIME:CONST (TIM:CON)

Sets the time constant for conversion into rms values. Or, queries the current setting.

Program message

- Syntax

Command message: `TIME:CONST <{0.01|0.1|1}>`
`TIM:CON <{0.01|0.1|1}>`

Query message: `TIME:CONST?`
`TIM:CON?`

- Program data

Data format: Real number

Values: 0.01, 0.1, or 1

(Example) Set the time constant for conversion into rms values to 0.1

`TIM:CON 0.1`

Response message

Returns the current setting in response to `TIM:CON?` in real numbers (0.01, 0.1, or 1).

UIS?

Queries whether measurements cannot be made.

Program message

- Syntax

Query message: `UIS?`

Response message

Returns the current setting in response to `UIS?` in real numbers (0 (yes) or 1 (no)).

4.4 Sample Program

```
'=====
' KJM6310 Sample Program

' A sample program using Microsoft Visual Basic 6.0.
' After setting the parameters, the jitter measurement value (%)
' is displayed once.
'
' The VISA library (VISA COM software) is used for RS-232C control.
' Use any of the following VISA library versions.
' NI-VISA 3.0 or later
' Agilent IO Libraries M.01.00. or later
' KI-VISA 2.2x or later
'
' Microsoft and Visual Basic are registered trademarks of Microsoft
' Corporation in the United States and/or other countries.
'=====
Option Explicit

' The Global Resource Manager (GRM) component object
Public m_rm As VisaComLib.ResourceManager

' VISA I/O session that is represented as IMessage VISA COM interface
Public m_session As VisaComLib.IMessage
'
Const MSG = "You need open the instrument with a valid VISA I/O resource"
'-----
Private Sub Form_Initialize()

    ' Create Resource Manager (RM).
    ' Select the VISA library to be used
    On Error Resume Next
    Set m_rm = CreateObject("VISA.GlobalRM") ' Use NI-VISA/KI-VISA
    On Error GoTo ERROR_HANDLER

    If m_rm Is Nothing Then
        ' Use Agilent IO Libraries
        Set m_rm = CreateObject("AgilentRM.SRMClS")
    End If

    ' Open the VISA I/O resource (use the RS-232C COM1 port)
    Set m_session = m_rm.Open("ASRL1::INSTR") ' RS232C COM1 Open

    Dim rs As ISerial
    Set rs = m_session
```

```

rs.BaudRate = 19200           ' Baud rate 19200 bps
rs.DataBits = 8              ' Data 8 bits
rs.StopBits = ASRL_STOP_ONE ' Stop 1 bit
rs.Parity = ASRL_PAR_NONE   ' Parity NONE
rs.FlowControl = ASRL_FLOW_XON_XOFF ' X-flow

```

```

' Other common settings
On Error Resume Next
m_session.TerminationCharacter = 10
m_session.TerminationCharacterEnabled = True
m_session.Timeout = 3000      'I/O timeout (in milliseconds)

```

```
Exit Sub
```

```
ERROR_HANDLER:
```

```

Dim strVisaCode As String
strVisaCode = "VISA Error: 0x" & Hex(Err.Number)
MsgBox Err.Description, vbExclamation, strVisaCode

```

```
End Sub
```

```
'-----
```

```
Private Sub Form_Load()
```

```

' Model information is checked(Maker, Model name, Version)
Dim strModelInfo As String
Call SendMessage(m_session, "*IDN?")
strModelInfo = ReceiveMessage(m_session)

```

```

If strModelInfo = "" Then
    Call CloseVisaResource
    Exit Sub
End If

```

```

' Measurement setup
Dim strAck As String

```

```

Call SendMessage(m_session, "PLL ON") ' PLL clock regen.
                                         ' circuit = ON

```

```
strAck = ReceiveMessage(m_session)
```

```

Call SendMessage(m_session, "SYM:MOD AUTO") ' SYMMETRY mode = AUTO
strAck = ReceiveMessage(m_session)

```

```

Call SendMessage(m_session, "DEL:MOD AUTO") ' DELAY mode = AUTO
strAck = ReceiveMessage(m_session)

```

```

Call SendMessage(m_session, "CLOC:TRIG:EDG POS") ' CLOCK edge =
strAck = ReceiveMessage(m_session)           ' POSITIVE

Call SendMessage(m_session, "RF:TRIG:EDG POS") ' RF edge =
strAck = ReceiveMessage(m_session)           ' POSITIVE

Call SendMessage(m_session, "TIM:CON 0.1") ' TIME CONST = 0.1 s
strAck = ReceiveMessage(m_session)

' Measurement of the JITTER value
Dim strImr As String
Dim strJitterPct As String
Dim strJitterNs As String
Do
    Call SendMessage(m_session, "IMR?") ' Get the measurement
    strImr = ReceiveMessage(m_session) ' status
Loop Until strImr = "1" ' Wait until the measured value is
                        ' less than or equal to 20 %

Call SendMessage(m_session, "JIT?") ' Get the jitter value (%)
strJitterPct = ReceiveMessage(m_session)

Call SendMessage(m_session, "JIT:TIM?") ' Get the jitter value
strJitterNs = ReceiveMessage(m_session) ' (ns)

' Display the JITTER value
MsgBox "Jitter Value = " & strJitterPct & "%"

Call CloseVisaResource

End Sub
'-----
Private Sub CloseVisaResource()

' Close the VISA I/O resource
If Not m_session Is Nothing Then
' Closes the VISA session
m_session.Close
Set m_session = Nothing
End If

End Sub
'-----
Function SendMessage(session As IMessage, strDat As String)

' Check if the VISA session is correctly opened
If session Is Nothing Then
MsgBox MSG, vbExclamation
Exit Function

```

```

End If

' Sends a device message string to the instrument.
On Error GoTo ERROR_HANDLER
session.WriteString (strDat & vbCrLf)' Add CR+LF

Exit Function

ERROR_HANDLER:
Dim strVisaCode As String
strVisaCode = "VISA Error: 0x" & Hex(Err.Number)
MsgBox Err.Description, vbExclamation, strVisaCode

End Function
'-----
Function ReceiveMessage(session As IMessage) As String

' Check if the VISA session is correctly opened
If session Is Nothing Then
    MsgBox MSG, vbExclamation
    Exit Function
End If

' Receives the response message from the instrument.
Dim strRd As String
On Error GoTo ERROR_HANDLER
strRd = session.ReadString(256)
' CR+LF Removed
strRd = Left(strRd, InStr(1, strRd, vbLf) - 2)
ReceiveMessage = strRd

Exit Function

ERROR_HANDLER:
Dim strVisaCode As String
strVisaCode = "VISA Error: 0x" & Hex(Err.Number)
MsgBox Err.Description, vbExclamation, strVisaCode

End Function

```

This chapter describes maintenance and inspection of the KJM6310. Conduct periodic maintenance and inspection to maintain the initial performance as long as possible.

5.1 Cleaning

If the panel needs cleaning, gently wipe using a soft cloth with water-diluted neutral detergent.

-
- ⚠ CAUTION**
- Be sure to turn off the power switch before cleaning.
 - Do not use volatile solvents such as thinner or benzene. They may discolor the surface or erase the printed characters.
-

5.2 Inspection

DC plug: Check for ruptures in the covering, play or cracks in the plug and so on.

-
- ⚠ WARNING**
- Breaks in the insulation coating may cause electric shock. If a break is found, stop using it immediately.
-

To purchase accessories, contact your Kikusui agent or distributor.

5.3 Calibration

The KJM6310 is calibrated at the factory before shipment. However, periodic calibration is necessary due to changes that occur after extended use.

For calibration, contact your Kikusui agent or distributor.

5.4 Troubleshooting

The symptoms listed below may not necessarily mean a malfunction. Check the KJM6310 before requesting repairs.

If the remedy does not solve the problem or if your case does not match any of the items, contact your Kikusui agent.

Table 5-1

Symptom	Check Items	Description
The KJM6310 does not operate even when the power switch is turned on.	Is the line voltage correct?	The allowable line voltage range is 14.5 V to 15.5 V. The line voltage may drop if the power supply capacity is insufficient.
	Is the DC voltage polarity correct?	For safety reasons, the fuse is designed to blow when the DC voltage polarity is reversed. If the fuse is blown, request for repairs.
Cannot make measurements.	Is the input amplitude adequate?	The input impedance must be 50 Ω , and the input amplitude must be at least 0.2 Vp-p. 1-M Ω probes cannot be used.
	Is the output impedance correct?	Check that the output impedance of the connected device and the cable impedance are 50 Ω .
	Is the duty cycle of clock signal outside the specifications?	The duty cycle specification of the clock signal is 45:55 to 50:50.
PLL does not lock.	Is the frequency correct?	The PLL of the KJM6310 can lock to fundamental clock frequencies between 4.1 MHz to 4.5 MHz.
	Is the amount of jitter too large?	The PLL of the KJM6310 can lock up to 17 %.

Symptom	Check Items	Description
The jitter measurement value is too large.	Is the delay adjustment correct?	When measuring the time interval jitter, the phase of the two signals must be matched.
	Is the edge (logic) of the RF signal and clock signal correct?	The edge of the RF signal after both edges have been detected cannot be measured on both edges. If the edge of other signals is not correct, measurements may not be made correctly. Check the edge settings. See “Recommended setup”, on page 3-7.
After power on, the ERROR LED blinks at 1-s intervals.	Is the RF signal disconnected?	Internal data error has occurred. Request for repairs.

This chapter describes the electrical and mechanical specifications of the KJM6310.

The specifications apply to the following conditions.

- Warm-up time: 30 minutes
- Temperature: 15 °C to 35 °C
- Humidity: 20 % RH to 85 % RH (no condensation)

6.1 Electrical Specifications

Input section

RF input	Input signal	EFM signal Minimum pulse width 15 ns
	Signal voltage range	0.2 V _{p-p} to 2 V _{p-p}
	Input impedance	50 Ω
	Maximum input voltage	±4 V (DC + AC peak)
	Input connector	BNC
CLOCK input	Input signal	Clock frequency 4 MHz to 18 MHz Duty cycle 45:55 to 50:50
	Signal voltage range	0.2 V _{p-p} to 2 V _{p-p}
	Input impedance	50 Ω
	Maximum input voltage	±4 V (DC + AC peak)
	Input connector	BNC

Measurement section

Measurement range	0 % to 20 % or 0 ns to 50 ns	
Spec guaranteed range	4 % to 15 % of the clock period	
Measurement accuracy	When measuring percentage	±0.75 % of the clock period
	When measuring ns	±2 % of the clock period
Residual jitter	2 % or less	
Time constant for conversion into rms values	10 ms, 100 ms, or 1 s	

Trigger section

Symmetry follow-up		AUTO, AUTO+ OFFSET, or MANUAL
Trigger edge	RF	Rising edge, falling edge, or both
	CLOCK	Rising edge or falling edge
Delay		Adjust the phase difference with the RF signal by delaying the CLOCK signal AUTO or MANUAL switchable MANUAL adjustment range 0° to 360°

PLL clock regeneration section

Frequency response characteristics are valid for reference clock = 4.3 MHz.

Synchronizable signal	EFM signal that corresponds to a fundamental frequency of 4.1 MHz to 4.5 MHz.
Frequency response characteristics (100 Hz reference, closed-loop characteristics) *1	1 kHz: 0.19 ± 1.7 dB 5 kHz: -0.15 ± 1.7 dB 10 kHz: -1.17 ± 1.7 dB 20 kHz: -3.82 ± 1.7 dB 25 kHz: -5.10 ± 1.7 dB
Lockup time	Within 700 ms
Synchronizable jitter range	5 % to 17 %
Residual jitter	2 % or less

*1 Complies with CD Reference: Compact Disc Reference Measuring Methods Specification Guideline Ver.1.0 May 1999.

Output section

DC OUT	Output amplitude (when open)	0.2 V/% and accuracy of ± 0.15 V
	Output impedance	Approx. 600 Ω
JITTER OUT	Output amplitude (when open)	20 mV/%
	Output impedance	Approx. 600 Ω

RS-232C interface

Connector type	D-SUB 9-pin connector (AT type connector)
Communication specifications	Start-stop synchronization, 9600 or 19200 bps, 8-bit data, no parity, 1-bit stop bit, and XON/XOFF control

6.2 General Specifications

Allowable line voltage range	14.5 V to 15.5 V DC	
Maximum power consumption	20 W maximum	
Spec guaranteed temperature and humidity range	Temperature: 15 °C to 35 °C Humidity: 20 % RH to 85 % RH (no condensation)	
Operating temperature and humidity range	Temperature: 0 °C to 40 °C Humidity: 20 % RH to 85 % RH (no condensation)	
Storage temperature and humidity range	Temperature: -20 °C to 60 °C Humidity: 90 % RH or less (no condensation)	
Dimensions (mm)	Approx. 45 W × 175 H × 210.5 D (Maximum dimensions: Approx. 45 W × 175 H × 240 D)	
Weight	Approx. 1 kg	
Accessories	Operation manual	1 pc.
	Stand	1 set (2 pcs.)
	Attachment screws	4 pcs. (M3 × 8 mm)
	DC plug	1 pc. (1.5 m)

6.3 External Dimensions

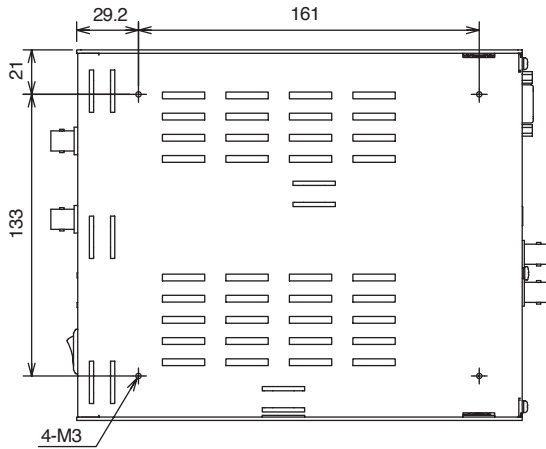
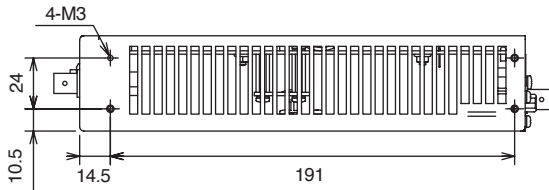
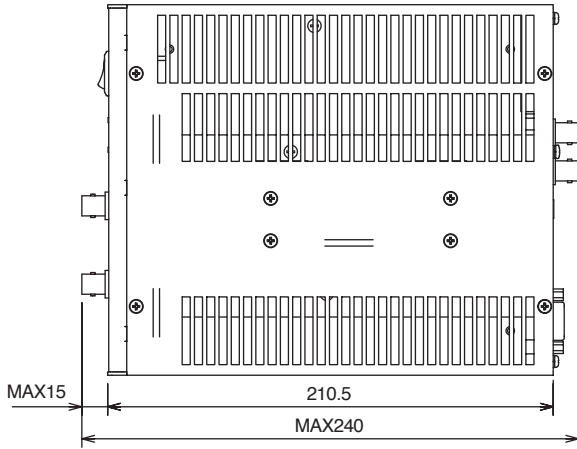
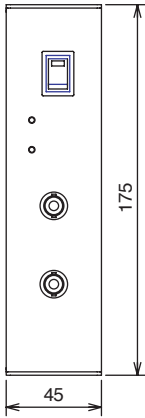

[Unit: mm]

TIME INTERVAL JITTER METER KJM6310

OPERATION MANUAL